

- - - - -

So many inquiries have come in regarding the "weaving for profit" plan suggested in the October Bulletin that I have decided to give the details to the whole circle through the Bulletin.

I want to begin by saying that in my opinion weaving for profit and weaving for pleasure are so different that one must choose definitely between them. It is of course quite possible ~~xxxx~~ to enjoy weaving for profit, and as far as possible the work should be shaped to that end, and it is possible, -- to a very limited extent -- to find some profit in weaving for pleasure, but in a general way the two things should not be confused. If we weave chiefly for the creative joy of the craftsman we must not be disappointed if our pleasure costs us money; and if we weave for profit we must be willing to weave the things people will spend their money for, and weave them with the least possible cost in materials and time. Either way one must be willing to give up something for the sake of success in the particular line one chooses. I want to make this very clear because it seems to me that a confusion here is the source of much disappointment.

Suppose we are quite clear about wishing to weave for profit -- we must then make a practical plan for commercializing our work. This part of the problem sometimes takes a good deal of experimenting that seems at the time costly and laborious, but it is necessary.

If you wished for instance to make money by cookery you would not bake three or four loaves of bread, each loaf a different size and compounded of different ingredients, and then perhaps make peppermint creams next day and orange marmalade the day after, -- and then wonder why the money did not begin to roll in. You would say: "I will bake bread", or "I will make candies", or "I will make jellies and preserves", selecting some particular line. You would then go about standardizing this line, determining just the size of loaf, and how much of each ingredient to use to make the best loaf that would sell at the price determined on, and still return a profit; and you would go about letting people know that you had homemade bread to sell, and you would keep a stock always on hand. The same process exactly must be pursued in setting up a weaving business. Of course it is possible to undertake to weave to order, as one might determine to cook to order, in which case the same standardization process must be gone through for a number of different products and samples must be prepared from which definite orders could be

taken. Unless you have made a particular thing before you cannot possibly know what it will cost you to make it or how much to charge your customer. If you leave the charge indefinite, to depend on the actual cost of time and materials for a particular project, the price may be a great shock to the customer and will not help to build up goodwill, which is the most important part of such a business.

As a weaver you are a manufacturer, but, if you plan to sell your own product you must also be a middleman and a salesman. Many people who have had no experience in business fail to realize the cost of selling an article. Articles of luxury such as hand-woven fabrics cost far more to sell than staple products such as everyone uses of necessity. These costs are entirely legitimate and are a necessary part of the selling price. Some people feel indignation at the idea of a selling commission, but if they stop to figure the costs of operating a selling agency of any kind, the time involved in showing people articles, in caring for the articles, the interest on capital invested in stock and fixtures, the cost of advertising even in a mild way in papers and magazines, or by mailing cards or booklets, they must see that the seller is fully entitled to his share of the buyer's money. In fact for most people making things is far pleasanter and easier than selling.

The shops rarely sell anything for less than twice the cost to them of the article, and stock that moves slowly must pay better even than this to show a profit. The very successful shop conducted by the Boston Society of Arts and Crafts finds it cannot pay expenses on thirty percent and has to have 33 1/3 percent in order to do business. No attempt is made to make a profit on the selling operation as this shop is conducted by the society for the benefit of the members, and this percentage represents the actual cost of selling.

I believe that by the plan suggested below it would be possible to conduct a selling agency at somewhat lower cost. The method of holding sales held in hotel parlors is used by a good many people who handle small articles of luxury. When properly brought to the notice of the people who are likely to be interested -- people with money and taste who appreciate unusual things -- such sales result in disposing of a good deal of material in a short time, at comparatively low cost.

This kind of selling is difficult, of course, and requires a sales-person of quite special ability and experience. It is possible that among our members there may be someone who has these qualifications and who will wish to undertake the selling end for us, -- if so, now is the ~~xx~~ time to come forward!

While to start a selling agency is an expensive thing and would not pay for a single weaver, it would, I believe, pay good profits for a group of weavers such as ours, -- particularly if our output is organized as I propose below.

I have been thinking about this whole problem for

some time, and the following tentative plan is the result. Suggestions are invited, and it is hoped everyone will return the questionnaire. This should be mailed direct to Mrs. Mary M. Atwater, Basin, Montana., and should be returned as promptly as possible.

WEAVING-for-PROFIT

In order to make a business of hand-weaving we must have quantity production and some means of marketing our product.

PRODUCTION is the first thing to consider. It may be a surprise to Guild members to learn that it is the smallness of our production that has held us back. Several times I have interested national selling agencies in our textiles, but each time the deal has fallen through because of the very limited quantities of goods I was able to guarantee. A selling agent cannot sell a single specimen of anything unless it be a thing of great value, like a light-house or a fifty thousand dollar diamond. There is no profit in selling a single baby-blanket or in selling a single dozen of baby blankets. The people who make a business of selling these things talk in terms of fifty dozen a week. Otherwise there is no money in it.

We have in the Guild plenty of looms and plenty of skilled weavers to insure a marketable quantity of product, provided the production is organized. And that is what I am proposing.

I suggest that in weaving for profit we limit ourselves to the following:

Wool rugs in three sizes, say 42" x 70", 36" x 60" and 27" x 50"
Cotton chenille rugs in the same sizes, and in a smaller size for bath-mats.

Large linen towels, to be 19" x 36" finished

Small linen "guest-towels", 16" x 24" finished

Mounted hand-bags in three sizes

Pieces of woven material for bags, to be made up by purchaser, in three sizes

Light-weight baby-blankets or shawls, 36" square, finished

Heavy weight baby-blankets or carriage robes, 32" x 40", finished

Crib-blankets or coverlets, 38" x 62"

Coverlets, twin bed size, 72" x 108"

full size, 84" x 108"

Sports sweaters

Linsey-woolsey dress-lengths, and by the yard, with samples from which special orders can be taken

Coat-material by the yard with samples

Upholstery material by the yard, in pieces of not less than 15 yards in 36" and 42" widths. With samples.

Chair-seats, 19" square.

Pillow-tops (both sides) in two sizes

Lunch-cloths in two sizes

Table-runners in two sizes, of linen, of wool, of silk

Curtain material -- pairs of sample curtains from which orders can be taken

Scarves, size and type to be determined by the latest in fashion.

I believe this list would give us variety and still be within practical bounds. In choosing from this list one should plan to make not less than half a dozen of large articles and several dozen of small things such as towels and pillow-tops.

Articles intended for sale should be tagged with the name of the maker and with the retail selling price. All pieces should be properly finished and boxed for handling in convenient units.

Anyone offering articles for sale will be expected to replace promptly all articles sold and to fill special orders. For these purposes a loom threaded for the special product should always stand ready and a sufficient stock of weaving materials should be kept on hand. Amusements and temporary lapses of interest should not be allowed to interfere with keeping these agreements.

- - - - -

SELLING

A properly organized selling agency to handle a stock of hand-woven fabrics could be made to pay excellent profits, I am assured. However to start the thing will require much hard work for someone and the investment of money. I have the following two plans to propose:

Plan No. 1

That a "Shuttle-Craft Guild Selling Group" be organized, each member to contribute cash toward the engaging of an expert salesman and toward the other expenses of a series of sales, these sales to be held in the best hotels of cities of fair size or in the "art departments" of leading department stores, etc. Each member shall also engage to supply hand-woven articles as outlined above to the value, let us say, of a minimum of \$200.00. The salesman would work on a percentage basis with guaranteed expenses and a salary minimum. The work of subscribing members would be sold on a 10% commission basis. The work of Guild members who are not subscribers could be accepted for sale subject to a 30% commission. At the end of the year there should be a good profit over and above the returns from sales, that could be divided among subscribers or used to extend the business.

This seems to me the most practical and businesslike method of handling the business, and I am in favor of adopting it, provided nineteen other Guild members will agree to subscribe. The subscription I suggest would be \$150.00 each to start the work, and \$50.00 more at the end of three months with another \$50.00 at the end of six months of operation if the additional assessment is required.

We could of course organize as an incorporate stock-company, and if the business develops as we hope this would certainly be desirable in time, but incorporation involves many expenses and many legal complications of reports and what not so that I believe we could manage for a year or two without incorporating.

Details of organization and the handling of stock, etc., need not be considered at present. These are things that can be decided if we find it will be possible to raise the money necessary to ini-

tiating the business.

Plan No. 2

That a "Shuttle-Craft Guild Selling Group" be organized and arrangements made to hold a definite number of sales during the year, these sales to be conducted by members of the group. Suppose we plan to have twenty sales, and that the group consists of twenty members: then each member will be expected to conduct a sale during the course of the year. If, instead, we decide to hold fifteen sales and have thirty members each sale will have two sponsors.

These sales need not necessarily be held in the place where the member in charge happens to live, but may instead be held in a near-by city that offers better possibilities for profit, or may be held anywhere that the responsible member or members elect. The member or members in charge may either act as salesmen themselves or may enlist the services of an experienced salesman. Sometimes, too, sales of this sort can be held under the auspices of a group of people, as an art club or the committee of a fashionable charity, the proceeds to go toward some public or charitable cause. Sales handled in this way are often particularly successful. Care must be taken, however, to put the sale into responsible hands and to make sure that it is held in a favorable location, such as the rooms of a prominent club or in the home of some rich and important person, and to have it properly advertised.

At sales under Plan 2 the woven articles contributed by participating members should be sold at a 10% commission and the work of non-participating Guild members or outside weavers at the 30% commission.

I consider this plan entirely practical, though it is not as business-like as Plan No. 1 and will be a good deal more difficult to handle. It will cost more in the end but less in the beginning than plan No. 1 and may be worth trying if Plan No. 1 fails of finding sufficient sponsors. It is the cheapest way of doing the thing at all adequately.

Please fill out and return the enclosed questionnaire.

* * * * *

SPECIAL NOTICE Readers of the Bulletin will be interested to learn that they may obtain hand-carved wooden bag-tops made by a member of the Guild. These are made in three sizes 8" rectangular; 8½" with rounded ends, and 9½" half oval. These sell at from \$2.75 to \$3.25 depending on size and amount of carving. They are made of solid walnut, and seem to me an ideal mounting for hand-woven bags. Address: Miss Paisy Strong, 109 Adams St., Greensboro, N.C.

* * * * *

We also have a used Practical loom for sale in Connecticut.

The pattern for this month is a rug-pattern similar to one of those given last month, but with a bolder effect due to the larger blocks. The weavings illustrated may be woven on last month's threadings if the smaller blocks are preferred. Of course the number of shots over the blocks must be reduced accordingly.

Draft (a) shows the Summer and Winter threading for a rug to be 36" wide, finished. For a wider rug, simply increase the number of units in each block. The warp is to be of 562 threads, threaded double through the heddles. If threaded single, -- which is also allowable 00 each block should be of 28 units instead of 14 as indicated on the draft.

Draft (b) shows a variation of the threading which gives a longer skip to the pattern weft and consequently a still bolder effect. However, a rug woven on draft (b) with tie-up (c) will produce a rug with a decided "right and wrong" sides while draft (a) if woven as indicated in the treadelings below will make a rug that is just as handsome on one side as on the other.

The treadelings have been written for woolen rug-yarn woven on tie-up (c). If woven on draft (b) with tie-up (d), use the pattern treadles in pairs. For instance weave the first block on treadles 1 and 2 alternately, and the second block on treadles 3 and 4 alternately, and so on.

There is no space to give complete treadelings for all the patterns shown but the following will serve to show the manner. It should prove simple enough to weave the other patterns from the illustrations.

Treadle Pattern No. 1 as follows:

Border

treadle 3,	dark;	treadle 4,	dark.	34 times.	
3,	light,	"	4,	light;	2 times.
3	dark	"	4,	dark	4 "
3	light	"	4,	light	2 "
3	dark;	"	4,	dark	4 "
3	light;	"	4,	light	2 "
3	dark;	"	4,	dark	6 "
1	"	"	2,	light	12 "
3	"	"	4,	dark	2 "
1	"	"	2,	light	2 "
3	"	"	4,	dark	2 "
1	"	"	2,	light	12 "
3,	"	"	4,	dark	6 "

end of border

(*) Stripes

Treadle 3,	light,	treadle 4,	light	- 2 times
3,	dark	"	4,	dark
3,	light	"	4,	light
3,	dark	"	4,	dark
3,	light	"	4,	light

Figure A

Figure A

Treadle 3,	dark,	treadle 4,	dark -- 6 times
1,	light,	" 2,	dark -- 4 "
3,	dark,	" 4,	dark -- 2 "
1,	light;	" 2,	dark -- 4 "
3,	dark;	" 4,	dark -- 6 "

Repeat stripes as above.

⁰Figure B

Treadle 3,	dark,	treadle 4,	dark -- 6 times
1,	dark;	" 2,	light -- 4 times
3,	dark;	" 4,	dark -- 2 "
1,	dark;	" 2,	light -- 4 "
3,	dark;	" 4,	dark -- 6 "

Repeat from (*) to end and then from (*) to (0).
Repeat border, reading from (*) back to the beginning.

Treadle Pattern No. 2 as follows:

treadle 3,	dark;	treadle 4,	dark, 24 or 26 times
3,	light;	4,	light, 6 times
3,	dark	4,	dark 6 "
3,	light	4,	light 6 "
1,	light	2,	dark 6 "
3,	light dark;	4,	dark 6 "
1,	dark	2,	light 6 "
3,	light	4,	light 6 "
3,	dark	4,	dark 6 "
3,	light	4,	light 12 6 "
1,	light	2,	dark 12 "
3,	dark	4,	dark 12 "
1,	dark;	2,	light 12 "

Repeat from the beginning three times, omitting the first line of the treadling, which is the border, on the second and third repeats. The repeat as before, omitting the last three lines and adding the border.

Treadle Pattern No. 3 as follows:

Treadle 1,	dark;	treadle 2,	light -- 6 times	Repeat from the beginning three times, and then repeat the first three lines of the treadling to complete the design.
3,	dark;	4,	dark 6	
1,	light;	2,	dark 6	
1,	dark;	2,	light 6	
3,	dark;	4,	dark 6	
1,	dark;	2,	light 18	
3,	dark;	4,	dark 6	
1,	dark;	2,	light 6	
1,	light;	2,	dark 6	
3,	dark;	4,	" 6	
1,	dark;	2,	light 6	
1,	light;	2,	dark 6	
3,	dark;	4,	" 6	
1,	light;	2,	" 10	
3,	dark	4,	" 6	
1,	light,	2,	" 6	

Weave all these patterns with a tabby.

Some New Tug Patterns

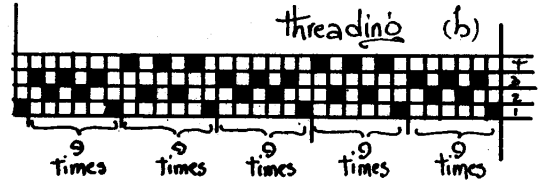
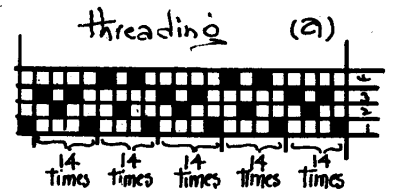
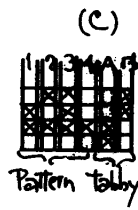
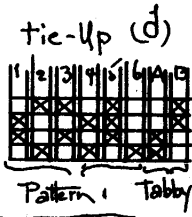
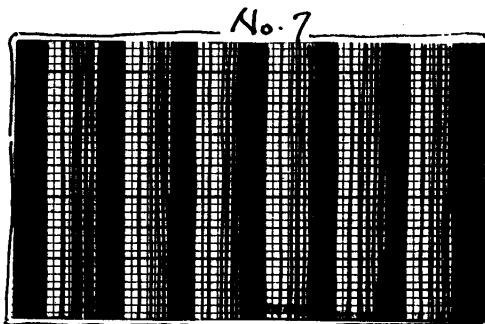
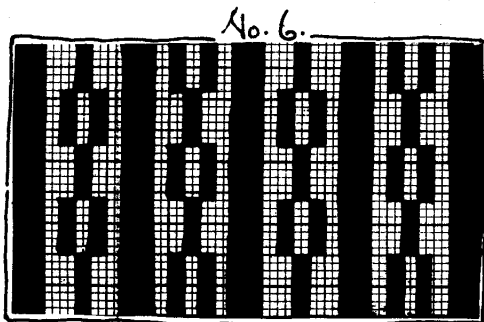
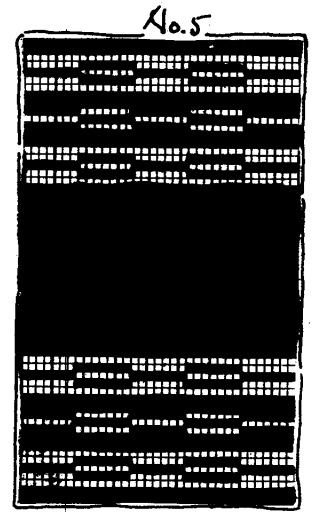
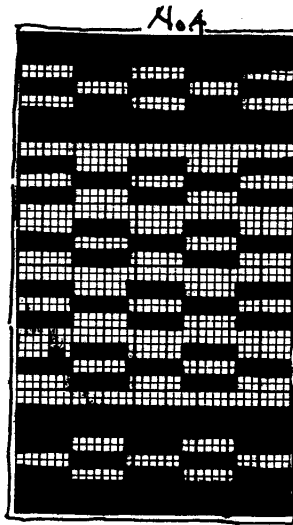
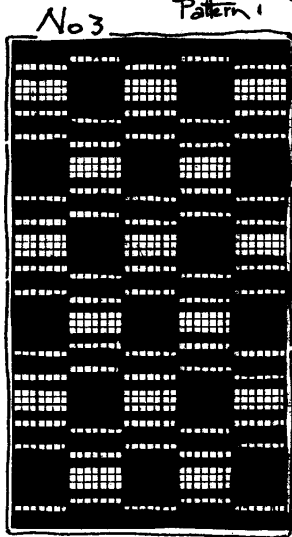
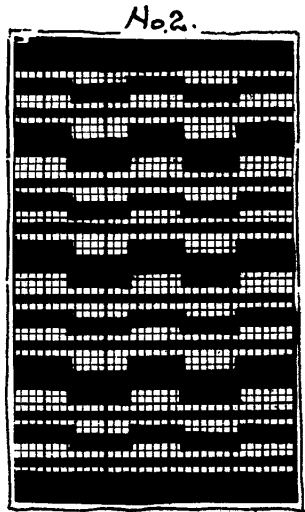
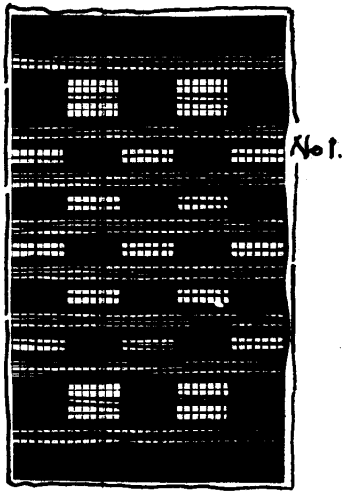

Mary M. Atwater
Basin, Mont. '29

FEBRUARY

1930

- - -

In past years it has been our custom to devote the January issue of the Bulletin to the great question of coverlets. This year the coverlet number has had to go over to February, - but there is plenty of time left for the making of a coverlet before spring weather will call us out of doors.

The weaver, I think, who makes a practise to weave a coverlet every winter is well rewarded; and the weaver who has never made a coverlet at all has so far missed the great adventure of the craft, and should be about correcting the omission.

It is a sort of happy magic - to take some spools of thread and some hanks of yarn and a few hours' time and turn them into a beautiful and useful thing that will last and serve for many years! It is hard to think of a pleasanter way to spend the time one has to spare during the bad winter days.

One need not be an experienced weaver to make a good coverlet - a beginner need not fear to undertake the project. And it does not take a great deal of time. Unless made of very fine materials in an very intricate weave, anyone who can weave at all can compass the whole process, from bearing the warp to sewing the strips together, in 48 hours of weaving time. This means a week of regular eight-hour days, or a month if one puts in two hours a day at the loom. We often spend much more time than that on things that are less amusing to do and have no lasting value at all. If all the crossword puzzlers had woven all their puzzle time into coverlets, think what a fine lot of new bed-coverings there would be!

The first step in making a coverlet should be careful planning. There are questions of weight - fine and light or coarse and heavy., - questions of pattern, of weave and of color, that are all to some extent dependent on one another, and that should be considered in relation to the room and the bed for which the coverlet is to be made.

We have, in a general way, three types of room - the "period" room completely furnished in antiques of some special period; the "style" room, completely furnished in some particular style, modernistic, for instance, and the less formal type of room that brings together perhaps a comfortable modern bed with a box spring, wicker chairs, a modern dresser of no very pronounced architectural style.

A coverlet that would be perfect in a room of type No. 1 would probably suit very ill in a modernistic setting, while one not strictly in the ancient tradition would mar the effect of a reconstructed Colonial room.

For a "period" room furnished completely in early American antiques, or in copies of old Colonial pieces, a strictly conventional Colonial effect should be chosen for the coverlet. The simple overshot type is the most suitable for rooms with "spool" beds and old pine furniture of the "cottage" order. For more elaborate rooms with carved four-poster beds, mahogany high-boys and similar pieces, the overshot coverlet is still satisfactory, though the more elaborate summer and winter weave is better.

The Colonial tradition limits us to the following color-arrangements: (1) very dark indigo blue, over a natural colored or bleached white foundation in cotton or linen, (2) the so-called "Colonial blue," which is a lighter shade of indigo. Same foundation. (3) Madder rose. This is a deep, brownish rose, verging almost on henna - never a true pink, same foundation. (4) Walnut brown. Same foundation. (5) A golden tan - same foundation. (6) Dark indigo and madder in combination. Same foundation. (7) Brown and tan in combination.

A combination of Colonial blue and madder is sometimes seen but is not often successful. Brown and rose together, and brown with indigo are rare combinations.

The dark indigo alone makes a very handsome and dignified coverlet, especially if used in a large and "rich" pattern, or in one of the patterns on opposites, or in the Summer and Winter weave. If the tone of the furniture is light and the walls of the room are light, this is probably the best color choice. Patterns that seem to me particularly suitable for weaving in dark blue are: "Pine Bloom", "Velvet Rose", "Miss Cobb No. 1", "Rose of Sharon", "Young Man's Fancy", "Lee's Surrender", "Governor's Garden", "Christian Ring", "Old South County", "Federal Knot", "English Flowers", "Double Lover's Knot", "Wheels of Time", "Blooming Leaf", "Washington's Diamond Ring". These are all patterns for overshot weaving. All the summer and winter weave patterns look well in very dark blue. It is the best color for most of them because it brings out well the fine proportions of the figures.

- - - -

Overshot patterns particularly good for weaving in light blue are: the gayer and more fanciful patterns, - "Whig Rose", "Maltese Cross", "Ferry's Victory", "The trellis", "Four-Leaved Clover", "Wheel of Fortune", "Double Bow-knot".

- - - -

Patterns that are good in brown and tan. "Sunflower", "Sunrise", "World's Wonder", "Old Roads", the "Arlington Coverlet", "Bonaparte's March", "Lace and Compass".

- - - -

Overshot patterns often woven in dark blue and red: "Double Chariot-Wheels", "Missouri Trouble", "Scarlet Balls", "Forty-Nine Snow-balls", "Queen's Delight", the "Patch patterns", "Dog-Tracks".

- - - - -
all

Old coverlets woven in rose are rather uncommon. The patterns listed as good for light blue are also suitable for rose, if one wishes this color.

As materials for Colonial coverlets nothing serves better -- in my opinion -- than warp and tabby of Egyptian cotton, 24/3, the warp set at 30 to the inch, with the pattern in homespun or Shetland yarn. The effect is almost exactly like the ancient pieces. But modern weavers often prefer to make a heavier, fluffier, warmer coverlet, and in that case should use four-fold Germantown yarn for pattern-weft over either the Egyptian warp or other fine warp. This is not strictly a Colonial effect and should probably not be used for a "period" room.

However, most of us who wish to weave coverlets have rooms in which modern and ancient pieces combine, and are not therefore limited to the strictest conformity with ancient usage. We can have fluffy coverlets if we like, and we can be much free-er in the use of color, choice of pattern, etc.

In planning a coverlet for such a bedroom the things to consider are the size of the room, color of the walls, whether the room is already crowded with ornament or whether it is rather bare, whether it is light or dark, etc.. We can have a more or less Colonial coverlet, a more or less modernistic coverlet, or anything else we please. We can have a silk coverlet if we like, or one of arts ilk over a linen foundation - things that would never do for the Colonial four-poster.

A coverlet with a large and striking pattern should never be made for a room with chintz draperies also in a striking pattern. The effect would be highly distressing. A very small and formal pattern should be used for the coverlet, - carried out in one of the colors of the chintz. The diamond is always good, or a pattern of small rose figures with the corners in one of the wheel patterns, or perhaps with a "sunrise" in the corners. This will give an attractive border with the main effect quite plain. Another way is to weave a coverlet in three strips -- a wide strip for the center and two narrower strips for side borders. The center can then be in plain tabby weaving, or in some very delicate little pattern, with the borders differently woven and perhaps in a different color or a different shade of the same color.

In a room with plain walls, and window-drapery, in a plain color, the coverlet should be made highly decorative. It will then be the "accent" of the room and will give it tone and character. A number of colors may be combined for such a coverlet and the pattern may be as elaborate as possible, or it may be dainty in light colors, or it may be serious and dignified according to the character one wishes to give the room. It is quite amazing what a change in the whole air of a room will be produced by a well-chosen coverlet.

Those of us who travel much and are forced to live in furnished houses or apartments know the value of a coverlet or two in changing impersonal drabness into a homelike atmosphere.

- - - - -

Nothing could be more exciting than to weave a modernistic coverlet, and I hope some of the Guild members will do this and will send in photographs of the result for illustration in the Bulletin. A number of the modernistic threadings given ~~in~~ from time to time in the Bulletin are excellent for coverlets in the modern manner. One thing that often gives trouble in planning a coverlet is deciding on the materials to use and calculating quantities of materials. The following table will prove helpful. The figures are for a regular full-sized coverlet, woven in two strips each 42" wide in the loom, the strips being woven three and a quarter yards long to allow for shrinkage. The quantities for warp are figured quite close, and are for a 42" warp, eight yards long. This is long enough to allow for take-up, the normal wastage in tying in, and leave enough for a narrow sample. One should always keep a sample of each coverlet woven. For spooled warps the calculation may prove a little scant owing to the weight of the spools, it would therefore be safe to add slightly to the quantities in ordering. It is cheaper in the end to have a little too much material than to have just not enough.

The quantities of weft material cannot be figured accurately without a woven sample exactly like the proposed weaving. The beat varies - the closer the beat the more material used. Also there is a difference between one pattern and another, as large open patterns beat up closer ~~than~~ and require more materials than fine patterns. The quantities listed are the average of several samples and are about correct for the majority of weavers.

Cotton warps

20/2 cotton and #20 perle cotton set 34 to the inch. Warp $1\frac{3}{8}$ lbs.;
 tabby about $\frac{7}{8}$ lbs. Total $2\frac{1}{4}$ lbs.
 Egyptian cotton 24/3, set at 30 to the inch. Warp $1\frac{1}{2}$ lbs., tabby
 about 1 lb. Total $2\frac{1}{2}$ lbs.
 Egyptian cotton 16/3 set at 24 to the inch. Warp $1\frac{7}{8}$ lbs., tabby
 about $1\frac{1}{4}$ lbs. Total $3\frac{1}{8}$ lbs.
 10/2 cotton, #10 perle cotton, set at 24 to the inch warp, $1\frac{5}{4}$ lbs.,
 tabby about $1\frac{1}{4}$ lbs. Total 3 lbs.
 #5 perle cotton, set at 18 to the inch. Warp $2\frac{1}{4}$ lbs., tabby about
 $1\frac{3}{4}$ lbs. Total $3\frac{3}{4}$ lbs.
 #3 perle cotton set at 10 to the inch. Warp $2\frac{1}{2}$ lbs. Tabby about $1\frac{5}{4}$
 lbs. Total $4\frac{1}{4}$ lbs.

Linen Warp 40/3 set at 30 to the inch. Warp 2-5/8 lbs., tabby about $1\frac{3}{4}$ lbs. Total $4\frac{3}{8}$ lbs.
Florelle warp, set at 30 to the inch. Warp $2\frac{1}{4}$ lbs., tabby about $1\frac{1}{2}$ lbs. Total $3\frac{5}{4}$ lbs.

The 20/2 warp and Egyptian 24/3 may be used for strictly Colonial effects, woven in overshot weave in homespun and Shetland yarns. Also woven in summer and winter weave in Fabri or Weaving Special yarns. Fluffy coverlets, not strictly colonial, may be woven in four-fold Germantown over the same warps. Italian strand cotton may also be used.

#20 perle cotton should not be chosen for strictly Colonial effects, but may be used for the less conventional coverlets, - woven in any of the materials listed above, and also in art silk.

The Egyptian 16/3 and the 10/2 cotton may be used for overshot weaving in Zephyr yarn for Colonial effects, and in four-fold Germantown for a fluffy coverlet. These warps are correct for the Summer and winter weave with homespun or shetland weft.

The coarser cottons may be made into very effective pieces when woven in heavy yarns but make, of course, heavy coverlets of the type known to old-time weavers as "nap-harlots".

The fine linen warp may be woven in homespun or Shetland yarn, for strictly Colonial effects. For modernistic fabrics it may be woven in silk or art silk.

Florelle should never be used as warp for a strictly Colonial coverlet.

Quantities of weft materials for one coverlet in overshot weave:

Fabri, about $2\frac{1}{2}$ lbs. Strand cotton, about $2\frac{5}{8}$ lbs.
Homespun yarn, about $3\frac{3}{4}$ lbs. Shetland about 4 lbs.
Germantown and Zephyr, about $4\frac{1}{2}$ lbs.
Mudijara, about $5\frac{1}{2}$ lbs. Art silk, about $4\frac{1}{4}$ lbs.

For Summer and winter weaving the quantities are a little less.

The January Bulletin of last year gave suggestions for finishing coverlets, different types of fringes, etc., which will not be repeated.

We all have so many patterns for coverlets that a new one is not given this year.

One of our Guild members has sent in a very attractive coverlet woven on the large crackle-weave pattern in the Bulletin for November 1928. This is a Colonial pattern known as "Three Flowers" but the translation into the crackle weave gives it a new expression. This pattern could not be woven on four harnesses except in this weave. I do not suggest it for either a strictly Colonial coverlet or for a modernistic one, but it is charming for a coverlet that does not have to be either one or the other. As

a border for this coverlet, repeat the first forty threads of the draft nine times or so, according to the width of border desired. The seam of the coverlet should be at thread 18 of the draft or at thread 110, - with the latter position preferred.

I have seen a very lovely coverlet woven on an unusual arrangement of the "Wreath Rose" pattern: like this, thread from the beginning of the draft to thread 150 and repeat. This makes four large wheels in the corners and also makes a handsome border. Thread the entire center of the coverlet to the small figure using as a repeat the threads from 151 to the end of the draft. The seam should come on thread 175 of the draft.

A different arrangement might be made as follows: begin at thread 151 of the draft and thread to the end; repeat. Then thread the complete draft as written, and then thread the center of the coverlet to the small figure as above. This is excellent for a room that requires a restrained treatment, and might be woven in dark blue, in light blue, or in blue and rose. In the latter case make the small roses in rose-color and the large figure and the connecting figures in blue.

A very charming and interesting coverlet is the one given at draft 108 of the weaving book. The draft was written from an old ~~xxx~~ coverlet in tones of brown and tan, seen in Cambridge, Mass. The draft as far as thread 420 is an elaborate border, and the center of the coverlet is threaded to the "Dog Tracks" figure -- the threads from 421 to the end of the draft, repeated as required. The seam of the coverlet should come either at thread 431 or at thread 453 of the draft. The very elaborate and rather illogical border and the simple figure in the center give an unusual effect. This would be a coverlet for a small, light room -- a boy's room perhaps. The treadling should be "as drawn in", the dog-tracks figures being woven star-fashion instead of rose-fashion. Though they may be woven rose-fashion if preferred. The 1-2 and 1-4 shots may be in one color and the 3-4 and 2-3 shots in the other.

One thing to be very careful about is to weave the strips of the coverlet so that they will match as exactly as possible. It is helpful to cut a paper gauge and measure each repeat as one goes along. Do not take the first strip off the loom and attempt to measure by that. The fabric shrinks as soon as the tension of the loom is relaxed and measuring in this way results in making one strip a good deal longer than the other.

If well matched the seam in an overshot coverlet will show hardly at all. In a summer and winter weave it shows more decidedly and for this reason summer and winter weave coverlets are often made in three strips instead of in two. The seams are less obtrusive on the sides than running through the center of the piece.

- - - - -

At this writing it is too soon to give the results of the questionnaire sent out last month. There will be an announcement in the March Bulletin.

SHUTTLE-CRAFT BULLETIN NO. 66

MARCH

1930

One of our Guild members has lately returned from a short trip abroad and writes an interesting letter which I wish to share with the circle.

She writes: "I saw much weaving on my trip. The most interesting in Paris was Evelyn Wild's. Her studio was up about four of the most rickety flights of stairs in a very old house on the Left Bank. She had about six old looms -- two harness -- and as many girls weaving. They were making perfectly plain dress-material. But there were many rugs. Original and rather startling in color combinations, and for the most part modernistic in design. All in tapestry weaving. The most beautiful rug I saw was one she exhibited at the fall Salon. It was part of a modern room, all in black and white. The rug was, I should say, about seven feet wide and eleven feet long -- not a usual size and shape -- long and narrow. The rug was all white with a dark grey fringe about 12 inches long. The design was shown by different thicknesses. It appeared to be an Egyptian figure done in modernist style. There were three depths of pile, one was plain weaving, one knotted and cut close and one knotted and cut about half an inch long. It really was very beautiful -- and about as practical as cloth of gold for a dish-rag!

"At another studio I found a man making scarves and dresses in silks and linens -- plain weaving with an inconsiderable design laid in. He had two decrepit looking old looms. He had one dress, the shape of a night-gown, made of beautiful soft fine natural linen with two or three rows of color making a border at the bottom of the skirt, and a very simple design above. Such a dress he sold for forty dollars, and he assured me he sold them as fast as he could make them. Simpler ones in silk sold for sixty dollars. I can't imagine anyone wearing them, although the weaving was beautifully done. He assured me he was an artist, but I think he was a financier!

"At Liberty's they had scarves and pocket-books to match, made of homespun wool. The scarves were about 10" wide and a yard long, -- design, or rather rows of bright colors, in one end only. The same on the purse. They also had squares, about a yard and a quarter square, made of wool in pale colors, medium weight wool -- not as fine as one would expect -- with borders all around.

"I saw Dr. Bell's work in London, too, (Dr. Bell is one of our Guild members). She does beautiful work. She told me the interest there seemed to be turning more and more toward modernist designs.

"Dr. Bell showed me some exquisite twoels, made in a soft, silky-looking linen such as seems to be fairly common in England. The fabric made of it is very lovely. Dr. Bell told me she used the Knox thread exclusively."

"Do you know 'Vegetable Dyes' by Ethel M. Mairret? -- St. Dominic's Press, Ditching, Sussex? It is considered over there the authority on dyeing. A paper covered book costing \$1.25. I saw some of her dyeing, and the colors were unusual and very lovely."

I feel sure that all this will be interesting to Guild members. Enclosed with this letter is one from Hank & Bryce, Limited, 77 Wellington Street West, Toronto 2, Canada, who are the Canadian distributing agency for the Knox Linen threads. They will be glad to supply sample cards and prices on request.

- - - - -

It has occurred to me that a discussion of pile fabrics might be of interest to Guild members. As far as I remember we have never taken up in detail this branch of our art.

Pile fabrics are very ancient, and probably originated in China, like most of the fine weaving in the world. But velvets and pile carpets were made in other places also at a very early date.

There are a good many ways of making pile fabrics. The Oriental carpets, as probably most people know, are made on a foundation in plain weaving, the design being tied in, knot by knot, between the shots of ground. This is an extremely laborious process and is not much practised in any but the Oriental countries. However, the white rug described in the above letter appears to have been made in this way, on a two-harness loom.

Tufted weaving is an entirely different process, though a rug similar in effect to the one described might be made in this way as follows: Warp with #3 perle cotton setting the warp at $7\frac{1}{2}$ ends to the inch, sleyed through every other dent of a 15 dent reed. (Instead one might warp ordinary carpet warp at 12 ends to the inch or at 15 ends to the inch, and thread double through the heddles). The experimental piece I tried was threaded on two harnesses, two threads through the front harness and one thread through the back harness. This seemed to me better than threading "one and one". But the one and one threading would give a more closely tufted effect. I used Zephyr yarn for the foundation and "Mudijara" for the tufts. Ordinary rug-yarn could be used for the latter, too. After weaving a foundation heading I threw a shot of the heavy material through the "over one under two" shed. I then picked up loops with my fingers -- a coarse crochet-hook could be used -- carrying them on a heavy wooden knitting needle. In coarse material this is not as slow a process as one might think. After weaving three shots of ground and beating them close I withdrew the knitting needle. In coarse material this is not as slow

a process as one might think. After weaving three shots of ground and beating them close I withdrew the knitting needles, threw another shot of coarse material and picked up another set of loops. By using needles of different sizes different depths of pile could be made by this method. The loops may be cut or left uncut as one prefers.

For fine work in tufted weaving the threading given at (e) of the accompanying diagram may be used. A good deal of Scandinavian work shows this technique and so does much interesting Spanish work. Some of the Guild members may recall that this work was described in the Sesqui-Centennial number of the Bulletin some years ago. (Copies of this Bulletin may be had for 25¢ each).

Tufted work made by drawing loops through a fabric previously woven is of course, merely an imitation of tufted weaving.

Colonial weavers produced a good deal of "fustian" for clothing. This is a pile fabric which we know as corduroy. The process of making it is described in my book and will not be repeated here as it is unlikely any of our circle will wish to make this particular type of material.

I cannot find that much velvet was woven in this country in the early day, -- as is indeed natural enough when one considers the hard life of the colonies and the emphasis on plain living and piety. Velvets are things of luxury.

A good deal of fine velvet is still made by hand, particularly in England. Tufted weaving and corduroy are weft-pile fabrics, but velvet is a warp-pile material. Two warp-beams are required, and the warp for the pile must be made six or eight times as long as the ground warp. The pile-beam or "pole" beam as it appears to be called sometimes, is usually set high in the loom, and instead of a ratchet and release is kept at sufficient tension by a weight on a cord, as illustrated at (f) of the accompanying diagram. As the warp unrolls the cord rolls up till finally the weight goes over the top and drops down on the other side. This keeps a gentle tension on the warp.

The foundation of velvet must be very firmly woven to hold the pile. It is woven in a fine thread, not always the same as the pile. For instance, cotton is sometimes used for the backing of a silk velvet, not only for economy but also because of the greater firmness.

After throwing four shots of ground and beating them very close the weaver raises the pile and inserts a wire. He then throws four more shots of ground and puts in another wire, and four more shots of ground. He then takes a little instrument called a trevette, which is equipped with a very thin sharp knife, and runs this across the loom, holding it close to the woven edge. The trevette is so adjusted that the point of the knife fits into a groove in the top of the first wire inserted in the shed, and cuts the pile. The weaver then puts in another wire and another four shots of ground and once more used the trevette. Only two wires are used. In very fine velvet there are as many as sixty rows of pile

tp the inch. An expert weaver can only make about a yard of ^{fine} velvet a day.

Uncut velvet is sometimes made, the wires merely being withdrawn and the pile left in loops. Sometimes, too, wires are used that have a cutting edge on one end so that when they are drawn out they cut the pile. This takes the place of the trevette.

A special arrangement of the cloth-beam is required for velvet weaving as the pile would be injured if the finished fabric were wound tight around the beam as in ordinary weaving. There are several types of beam used. In one type the finished fabric passes around a bar shed with needle-points that hold it in place, and is then led to a box under the loom where it hangs over hooks. Another type of velvet beam is described in Luther Hooper's handbook of Weaving and is illustrated with diagrams that any carpenter could follow.

A very simple manner of making a warp-pile fabric, often used for making Turkish towelling, is shown at (a) of the diagram. The black squares of the draft indicate fine threads of foundation warp and the circles represent pile-warp threads. The pile must be warped on a special beam as in velvet weaving, but this beam should be provided with a ratchet and release. The work can, as shown on the draft, be done on two harnesses.

The process of weaving is as follows: first weave a heading in foundation thread; then insert in the shed a strip of wood or cardboard about half an inch wide -- narrower if one prefers -- and weave four shots of ground, beating fairly close. Now release the pile beam so that the pile warp will be slack, withdraw the strip, and with a sharp blow of the batten drive the last threads woven back against the heading. The pile, being loose, will stand up in a series of loops.

Of course no pattern is possible by this method, though one might introduce stripes of color. One might also make towels by this method, threading the foundation warp to any desired pattern on which borders may be woven in the ordinary overshot technique, the body of the towel being woven in terry as above. The pile-warp may be entered after each third thread of ground-warp, either through the same heddle, or, better, through a heddle on the same harness. As: 1,2,3, ground threads; 3 again, pile-thread; 4, 1, 2, ground threads; 2, pile thread; and so on. This is not shown on the diagram.

The threading at (b) shows the manner of weaving a simple warp-pile fabric on three harnesses. The effect is similar to the fabric woven on two harnesses, but is more exact in operation and is used for velvets. The ground is woven on the two front harnesses and at intervals the pile is raised and wires put in as already described.

At (c) of the diagram is shown a method of weaving a pile-fabric on four harnesses in any two-block pattern. Two separate beams will be required for the pile warp, each separately weighted, as the tension will be different for the two blocks. The method of weaving hardly requires description as it must be self-evident. By using wires of different sizes pile of varying lengths can be made, giving a good deal of variation in effect.

At (d) is given a threading for eight harnesses, on which elaborate patterns of six blocks could be woven. Six separate pile-beans would be required, of course, one for each block of the pattern.

For the greatest possible freedom in design, however, a different method may be used. The warp should be threaded as at (b) and a single pile-bean will be sufficient. Each strand of pile, however, should be separately weighted. This can be done by threading each strand through a small ring before entering through the heddles. These rings will run freely on the threads and to them small lead weights may be attached - weights such as are used in draw-loom weaving. A sketch of such an arrangement is shown on the diagram at (g).

When set up in this fashion one may introduce wires under the pile at any points desired and may follow any design one chooses. It is a far swifter method of producing patterns in pile than the tufting process described earlier in this article.

I hope members of the Guild will find these notes not only of interest but of practical use, and will be inspired to experiment with pile fabrics. It is a rather new field for hand-weaving - in this country at any rate, and has promising possibilities.

T - - - - -

The travelling collection of modernistic weaving has been proving interesting to participating members. It is still on tour and is at present progressing along the eastern coast. The interest has been so great that I plan to start another travelling exhibit -- perhaps next Summer. So will everyone keep this in mind and make something to be included.

- - - - -

The questionnaires on the sales-service plan are not all in, but I am beginning to doubt whether we shall have enough participating members to carry the plan. So far only about half the minimum number have indicated a willingness to invest. There are not, either, as many of our members as I expected who are willing to bind themselves to a definite production for sale at a commission. It appears to me, therefore, that our group is essentially a "weaving for pleasure" group, and that the matter of a sales outlet is less important to our membership than I supposed.

I shall keep the matter open for another month, to give the Guild an opportunity for full expression, but on the face of the present returns the sales organization is not likely to be undertaken -- at least not for the present. I feel very strongly that a reasonable working capital is necessary for success, and unless the thing is properly financed it is bound to fail, the loss falling on our members.

The alternative would be to find some person who is ambitious to develop the sales end of hand-weaving, who is prepared to finance it personally and depend on commissions for salary and profits. Here is an opportunity for one of our members. I have always believed

that there might be a handsome profit in this side of the hand-weaving game. However, I do not feel that I am the person to do it as I am not a salesman and am, I confess, personally more interested in the artistic rather than the commercial aspects.

- - - - -

A letter comes to us from a Mrs. Iona Dennis of P.O. Box 86, Boise, Idaho, who has an established weaving business in Edmonton, Alberta, Canada, which she wishes to sell as she has married and come to this country with her husband. She has a registered trade name, equipment, some material and some dresses and suits made up, various advertising material, etc., which she is willing to sell much below cost. Anyone who might be interested should communicate with Mrs. Dennis direct. She is not a member of our Guild and we know nothing of this proposition except what she has written to us, but for anyone planning to go there, the thing seems well worth looking into.

- - - - -

Mary M. Atwater.

- - - - -

One of our Cape Cod weavers finds it necessary to dispose of her weave-room equipment, consisting of one two-harness loom, one Practical 8-harness loom, and one Structo #600 table loom, together with various reeds, materials, etc.

If the entire lot is sold at once, a special price can be made on it, although the party is perfectly willing to sell the looms singly if anyone desires them.

For further particulars kindly address the Cambridge office.

- - - - -

Several Methods for Weaving pile fabrics.

Shuttle-Craft Bulletin
March 1930.

(a) Warp-pile on 2 Harnesses



(b) Warp-pile on 3 Harnesses

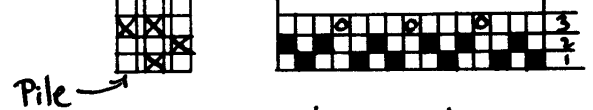

(c) Warp-pile on 4 Harnesses

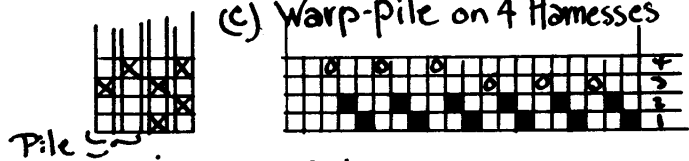

(d) Warp-Pile on 8 Harnesses

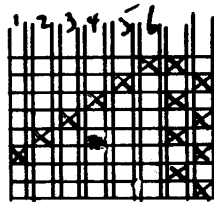
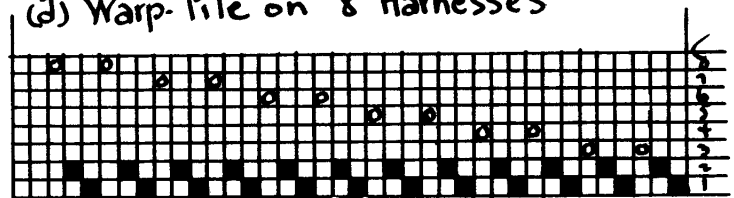

(e) Threading for Tufted Weaving

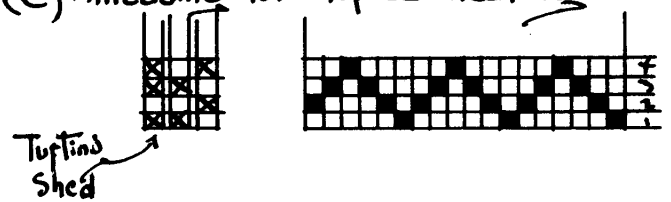

(f) Method of weighting "Pile" beam

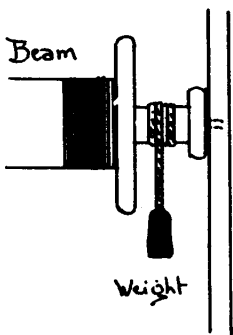

(g) Method of weighting single strands of pile warp

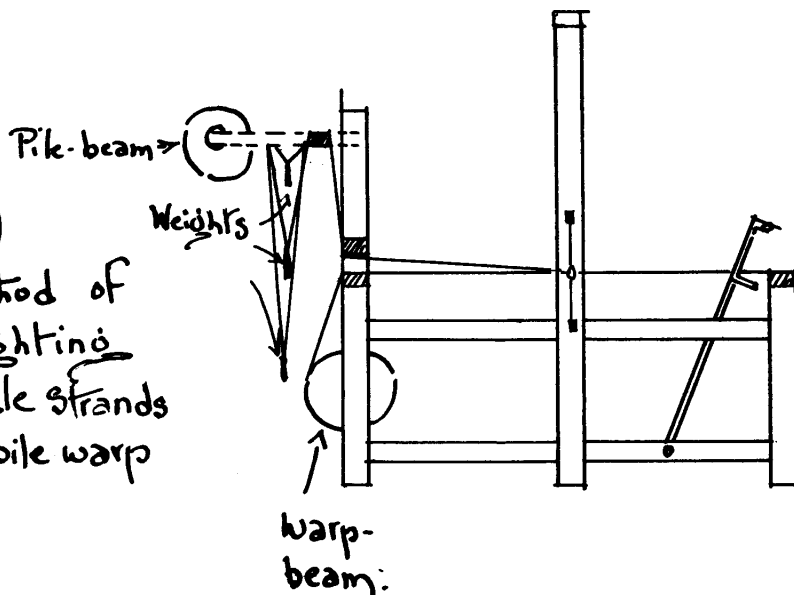

SHUTTLE-CRAFT

BULLETIN NO. 67

APRIL 1930.

- - -

To continue the subject of last month, which is of interest to many, our diagram this month shows three designs for tufted weaving, arranged especially for rugs, but suitable for other uses if desired.

These patterns may be produced on a simple two-harness loom, by the method explained in last month's Bulletin, but the four-harness method detailed below is to be preferred.

Pattern No. 1 is a bold design in triangles. It could be made in tufting of one color, the white lines being left untufted. Or it could be made in two colors, in a solid effect, the light lines being tufted in a second color. Or it might be worked out in two colors, making the large triangles in one color and the small triangles in another, the light lines being left untufted. Or it might be done in three colors, the large triangles in one color, the small triangles in another, the light lines in the third. Or it could be worked out in pile of different lengths. Finally, shaded effects in many different colors could be produced on this pattern.

In following the pattern the small squares of the paper should be taken to represent a certain number of knots as will be more fully explained below.

Pattern No. 2 is a Navajo type of pattern, and may be made in two colors on an untufted background, or in three colors for a solid effect, or in different lengths of pile.

It may be noted here that the effects with a plain ground are rather "newer" and more interesting than the solidly tufted work.

Pattern No. 3 may be made in two colors, three colors, or in different lengths of pile. As this is a rather intricate pattern to follow from the drawing, complete directions are given for weaving in two colors with untufted or plain ground.

To weave this pattern as a rug, set carpet warp at twelve threads to the inch, 36" wide in the reed. Thread twill-fashion 1,2,3,4, 1,2,3,4, etc.

For weft material use rug-yarn, "mudijara", or fine-cut rags for the pile weft, and use carpet-warp for the ground. Zephyr yarn can be used for the ground instead of carpet warp and makes a heavier rug, but is, of course, more costly. Chenille might be used for the ground weft, though it would not be suitable for the pile.

The ground weft can be woven either on the regular tabby sheds or on treadles 1 and 3. If carpet warp is used for the ground the ordinary tabby sheds are best, but if a heavier ground weft, such as chenille, is used it will be best to use the other sheds.

The tufting sheds will be treadles 1 and 3, or treadle 1 alone. For patterns 1 and 2, that feature slanted lines, it is to use the tufting sheds alternately, as this "stagger" the tuft but for pattern 3 in which the lines are all horizontal or perpendicular, it is better to use only one tufting shed. Either of the tufting sheds gives, with the setting suggested, three tufts to the inch, and in heavy material this is sufficient.

One should be provided with a number of heavy wires, small rods, or -- as suggested last month -- large wooden knitting needles. If the pattern is to be produced in pile of different heights, two sizes of wires or knitting needles must be on hand. Wires long enough to reach all the way across the loom are awkward to handle, and the method of using several short wires rather than one is recommended.

The directions below are for weaving the pattern beginning at the bottom, and the rows are written from left to right. In the actual work one picks up the tufts beginning at the left of one shot and beginning on the right on the next shot, - this must be remembered in reading the directions. When you pick up the tufts from left to right they follow the order as written, but when you begin at the right and work to the left, follow the directions in inverse order.

The method of weaving the pattern part of the rug is to throw a shot of tufting weft on treadle 1 followed by a tabby shot each way in carpet warp. This brings the tufts close together. Three or four shots of tabby warp may be used between tufting shots if preferred. This makes a thinner and less substantial rug, however.

As rug No. 3 is shown in two colors and ground, a tufting shot of each color must be thrown each time through the tufting shed. The inch of plain ground with which the rug begins is woven treadle 1, color (a); treadle 1, again color (b); tabby a, tabby B, and repeat.

There will be 108 skips in tufting thread in the width of the rug. The second inch of the rug is woven as follows: treadle 1, color (a); treadle 1, color (b); pick up on the wire 27 loops of color (b), beginning with the 61st skip, counting from the left; tabby a, tabby b; repeat as required for an inch in depth. About five rows of tufting will make an inch, though this depends on the beat. Close beating is desirable.

The third inch of the rug is woven in a similar way, though both colors are picked up in places to make the pattern. One may throw first color (a) and pick up the (a) tufts and then throw color (b) and pick up those tufts, - the shed remaining open all the while - or one may throw both tufting shots and pick up first one color and then the other on the same wire. It is a matter

of convenience only. The wires may be withdrawn after the tabby shots are woven in, so that no large number of wires is required.

The process as described may seem slow and toilsome, and it is, of course, a good deal slower than plain weaving. However it is far more rapid than the making of hooked rugs, or pile rugs in the Smyrna knot.

Weaving Directions Rug #3

- First weave a tabby heaving in carpet warp. ~~explained~~
1. Weave one inch plain ground as explained, two shots of pile weft through the same shed, followed by two tabby shots.
 2. 60 plain skips; 21 tufts, color (b); 27 skips plain. Tabby. Repeat for one inch.
 3. 6 skips plain; 18 tufts color (b); 12 plain; 9 tufts color (a); 15 plain; 21 tufts color (b); 27 plain. Repeat for one inch.
 4. 6 plain; 18 tufts color (b); 12 plain; 9 tufts color (a); 6 plain; 12 tufts color (a); 6 tufts color (b); 33 tufts color (a); 6 plain. Repeat for one inch.
 5. Same as 4 except that instead of the last 6 "plain" it ends 3 tufts (color b); 3 plain.
 6. 6 plain; 3 tufts color (b); 36 tufts color (a); 15 plain; 9 tufts color (b); 9 tufts color (a); 3 tufts color (b); 12 plain 12 tufts color (b) 3 plain.
 7. 6 plain; 3 tufts color (b); 36 tufts color (a); 3 tufts color b; 12 plain; 9 tufts color (b); 9 tufts color (a); 3 tufts color (b); 12 plain; 12 tufts color (b); 3 plain.
 8. 6 plain; 3 tufts color (b); 9 tufts color (a); 6 tufts color b; 15 plain; 9 tufts color (b); 12 ~~tufts~~ plain; 9 tufts color (b); 30 tufts color (a); 6 tufts color (b), 3 plain.
 9. 9 plain; 9 tufts color (a); 21 plain; 9 tufts color (b); 21 plain; 30 tufts color (a); 9 plain.
 10. 9 plain; 9 tufts color (a); 33 plain; 9 tufts color (a); 18 plain; 9 tufts color (b); 3 plain; 9 tufts color (a); 9 plain.
 11. 9 plain; 9 tufts color (a); 18 plain; 9 tufts color (a); 6 plain; 9 tufts color (a); 18 plain; 9 tufts color (b); 3 plain; 9 tufts color (a); 9 plain.
 12. 9 plain; 9 tufts color (a); 3 plain; 9 tufts color (b); 6 plain; 9 tufts color (a); 6 tufts color (b); 30 (a); 6 (b); 3 plain; 9 (a); 9 plain.
 13. 9 plain; 36 (a); 6 (b); 30 (a); 9 plain; 9 (a); 9 plain.
 14. 9 plain; 36 (a); 6 (b); 9 (a); 9 (b); 21 plain; 9 (a); 9 plain.
 15. 21 plain; 9 (b); 12 plain; 9 (b); 9 (a); 9 (b); 15 plain; 6(b). 9 (a); 6 (b); 3 plain.
 16. 42 plain; 9 (b); 9 (a); 6 (b); 33 (a); 6(b); 3 plain.
 17. 18 plain; 42 (a); 6 (b); 33 (a); 6 (b); 3 plain.
 18. 3 plain; 15 (b); 42 (a); 9 (b); 15 plain; 21 (b); 3 -lain.
 19. 3 plain; 21 (b); 18 plain; 9 (b); 9 (a); 9 (b); 15 plain; 21 (b); 3 plain.
 20. 3 plain; 21 (b); 27 plain; 9 (a); 12 plain; 30 (a); 3 (b); 3 plain.
 21. 3 plain; 3 (b); 39 (a); 27 plain; 30 (a); 3 (b); 3 plain.
 22. 3 plain; 3 (b); 39 (a); 18 (b); 9 plain; 9 (a); 3 plain; 9 (b); 9 (a); 3 (b), 3 plain.
 23. 3 plain; 21 (b); 12 plain; 15 (a); 12 b; 6 plain; 3 (b); 9 (a); 12 plain; 9 (a); 6 plain.
 24. Same as 23.
 25. 3 plain; 21(b); 15 plain; 3 (b); 9 (a); 9(b); 21 (a); 12 plain; 9 (a), 6 plain.

26. 3 plain; 3 (b); 45 (a); 9 (b); 21 (a); 12 plain; 9(a); 6 plain
27. 6 plain; 45 (a); 12 (b); 6 plain; 12 (b); 12 plain; 9 (a); 6 pl
28. 6 plain; 9 (a); 6 plain; 9 (a); 9 plain; 3 (b); 9 (a); 12 (b);
18 plain; 12 (b); 9 (a); 3 (b); 3 plain.
29. 6 plain; 9 (a); 6 plain; 9 (a); 9 plain; 3 (b); 9 (a); 6 (b);
9 (a); 6 plain; 30 (a); 3 (b); 3 plain.
30. Same as 29.
31. 6 plain; 9 (a); 6 plain; 9 (a); 9 plain; 18 (b); 9 (a); 15
plain; 24 (b); 3 plain.
32. 6 plain; 9 (a); 42 plain; 9 (a); 15 plain; 24 (b); 3 plain.
33. 6 plain; 9 (a); 18 (b); 3 plain; 9 (a); 12 plain; 27 (a); 21
(b); 3 plain.
34. 12 plain; 21 (b); 3 plain; 9 (a); 6 plain; 6 (b); 27 (a); 21 (b);
3 plain.
35. 12 plain; 21 (b); 3 plain; 9 (a); 6 plain; 9 (b); 15 plain;
9 (a); 6 (b); 12 (a); 3 (b); 3 plain.
36. 9 plain; 21 (a); 3 (b); 3 plain; 9 (a); 6 plain; 9 (b); 15
plain; 9 (a); 6 plain; 12 (a); 6 plain.
37. 9 plain; 21 (a); 3 (b); 3 plain; 9 (a); 18 plain; 12 (b); 9
(a); 3 (b); 3 plain; 9 (a); 9 plain.
38. 9 plain; 9 (a); 3 (b); 9 (a); 3 (b); 3 plain; 9(a); 18 plain;
12 (b); 9 (a); 3 (b); 3 plain; 9(a); 9 plain.
39. 12 plain; 9 (b); 9 (a); 3 (b); 3 Plain; 48 (a); 3 (b); 3 plain;
9 (a); 9 plain.
40. Same as 29.
41. 3 plain; 9 (b); 9 plain; 9 (a); 33 plain; 24(b); 3 plain; 9(a);
9 plain.
42. Same as 41.
43. 3 plain; 3 (b); 9 (a); 6 plain; 48 (a); 18 (b); 3 plain; 9 (a);
9 plain.
44. 6 plain; 9 (a); 6 plain; 48 (a); 6 (b); 24 (a); 9 plain.
45. 6 plain; 9 (a); 45 plain; 9 (a); 6 plain; 24 (a); 3 (b); 6 plain;
46. 6 plain; 9 (a); 12 plain; 24 (b); 9 plain; 9 (a); 6 plain; 9 (a);
6 plain; 12 (b); 6 plain.
47. 6 plain; 36 (a); 9 (b); 9 plain; 9 (a); 6 plain; 9 (a); 6 plain;
12 (b); 6 plain.
48. 6 plain; 36(a); 9 (b); 9 plain; 9 (a); 6 plain; 21 (a); 6 (b);
6 plain.
49. 6 plain; 36 (a); 6 (b); 21 (a); 6 (b); 21 (a); 12 plain.
50. 9 plain, 9 (a); 9 plain; 6 (b); 9 (a); 6 (b); 21 (a); 15 (b);
24 plain.
51. 9 plain; 9 (a); 6 (b); 9 (a); 6 (b); 9 (a); 9 plain; 18 (b);
12 plain; 9 (b); 3 plain.
52. 9 plain; 9 (a); 9 plain; 6 (b); 9 (a); 6 (b); 9 (a); 9 plain;
12 (b); 24 (a); 3 (b); 3 plain.
53. 9 plain; 9 (a); 9 plain; 6 (b); 9 (a); 9 (b); 15 plain, 12 (b);
24 (a); 3 (b); 3 plain.
54. 3 plain; 6 (b); 9 (a); 3 (b); 6 plain; 24 (b); 15 plain; 18 (b);
9 plain; 9 (a); 3 (b); 3 plain.
55. 3 plain; 6 (b); 9 (a); 3 (b); 30 plain; 12 (b); 9 (a); 12 (b);
9 plain; 9 (a); 6 plain.
56. 3 plain; 6 (b); 45 (a); 9 (b); 9 (a); 21 plain; 9 (a); 6 plain.
57. 3 plain; 6 (b); 45 (a); 9 (b); 39 (a); 6 plain.
58. 3 plain; 18 (b); 24 plain; 9 (a); 9 (b); 39 (a); 6 plain.
59. 51 plain; 15 (b). 42 plain.
60. One inch woven plain.
Tabby heading.

By the same technique any cross-stitch pattern may be followed in tufted weaving allowing a certain number of tufts to the square. It is by this method that rabbits and ducks, flowers and what-not are sometimes woven for the borders of baby blankets. The design should first be worked out on cross-section paper. I have often been asked for this information.

An easier method of doing this work, in complicated patterns, is open to those who use looms with more than four harnesses. Any pattern, for instance, shown for the summer and winter weave may be used, the figure being produced in tufts picked up over the pattern blocks. The special eight-harness modernistic pattern - the "Step pattern" - would be particularly useful in this connection. Woven in this fashion there is no need of counting the skips as the ones picked up appear clearly in the shed.

Any two-block Summer and Winter pattern may be woven in the same way on a four-harness loom. Pick up one block in one color, throw the other block and pick that up in a different color, or pick up one block only leaving the other block in plain ground. Some very interesting effects are possible in this simple technique.

Take for instance, pattern No. 3 in the Bulletin for Jan. 1930. This should be threaded according to draft (a). If woven in tufts of one color with plain ground the process would be as follows: tabby heading in warp-thread first; then weave a two-inch solid tufted border made by throwing the tufting thread on treadle 5 and picking up each skip all the way across. Two tabby shots between tufting shots. Weave the next inch by throwing the tufting weft on treadle 3, and picking up all the skips of the pattern blocks. The next inch is woven on treadle 1, in the same manner. To weave a rug in solid tufted effect weave the bottom border as already indicated, using the darker of two colors for the tufting. Weave the next inch as follows: treadle 3, in the darker color, pick up tufts; treadle 1, lighter color, pick up tufts; tabby A, tabby B. Repeat. Next inch treadle 1 in darker color and treadle 3 in lighter color. And so on.

The crackle-weave patterns can be used for tufting in a similar manner, and will give some unusual and interesting effects.

In finishing a tufted rug the loops may be cut or may be left uncut as preferred, or one part of the pattern may be cut and another part left uncut. Also, as described last month, different parts of the pattern may be developed in pile of different lengths - part trimmed close and part allowed to remain long. So it will be seen that a great deal of interesting variety is possible in this type of weaving.

We have an announcement to make: The Cambridge office is to be discontinued. Mrs. Norrington who has carried on the office for the last two years is moving away from Cambridge, and it is quite impossible for me to manage from here the detail of yarn orders and orders for equipment. There will be no change in the course, nor in the Bulletin, and it is hoped the change will work no great hardship on Guild members.

As you know, most of the yarns, warps and so on that we have been supplying come from the Emile Bernat & Sons Company of Jamaica

Plain, Mass., with whom arrangements have been made to fill orders direct. Certain materials which we have had made up at various factories specially for us -- such as spun silks, the strand cottons, and so on -- will be discontinued.

Full information as to where looms, equipment, etc. may be obtained will be sent forth with the May Bulletin.

* * * * *

Questionnaires are still coming in, in regard to the selling plan. Most of those received favor Plan No. 1, which seems to me the best plan. Perhaps if we continue to discuss it we may before long find some way to put it into operation. One of our members asked an opinion of a prominent business man, and his reply, from which I quote, is of interest.

Plan No. 1 is to my ~~mind~~ mind sound provided a sufficient amount of funds is obtained in the first instance. All such organizations go on the rocks if insufficiently financed. A good plan is to make an estimate of the budget and then double it. Furthermore the finances should be properly administered or else any number of leaks will occur. The obtaining of a good sales manager is essential and unless proper audits at stated intervals be made the money will simply slip away. While incorporation may not be necessary a definite contract must be made between the administration and the members of the organization, requiring a financial statement at intervals of at least every six months. The administrator of this plan is liable to be inveigled into doing work with some talkative salesman who will not be responsible. Far better that the plan be organized with a small beginning, having contracts with a group of retailers. Continuing this a reasonable time in order to show what profits can be made the organization can be expanded.

"Another point is the amount of production. In any selling organization organized as this is a standard minimum wholesale production must be maintained by the members of the organization and they must agree before hand that this minimum will be sustained. This production must also include a standardization of product. Better have the number of products small than large. Lacking an incorporation, some partnership agreement should be made between the members and those administering the funds and engaged in making retail contacts and contracts.

"I think from my own investigation that there should be a large market for good hand-woven articles such as described on page 270. I have long wondered why a Guild was not organized for the production of such things and their sale in the better shops throughout the United States. There should be a strong appeal to women of taste and means and I see no reason why it should not meet with exactly the same success as other superior articles."

* * * * *

One of our Guild members forwards the following information: "I find, according to P.O. officials, that the address given for the purchase of the book on Vegetable Dyes should read: "Ditchling Hamocks, Sussex, England."

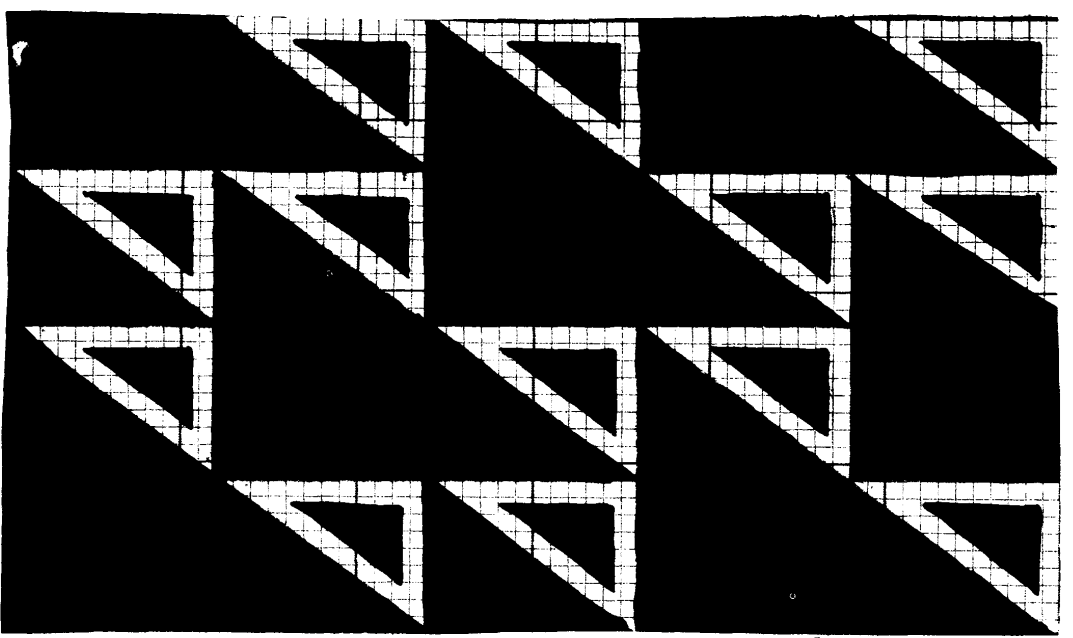

No. 1

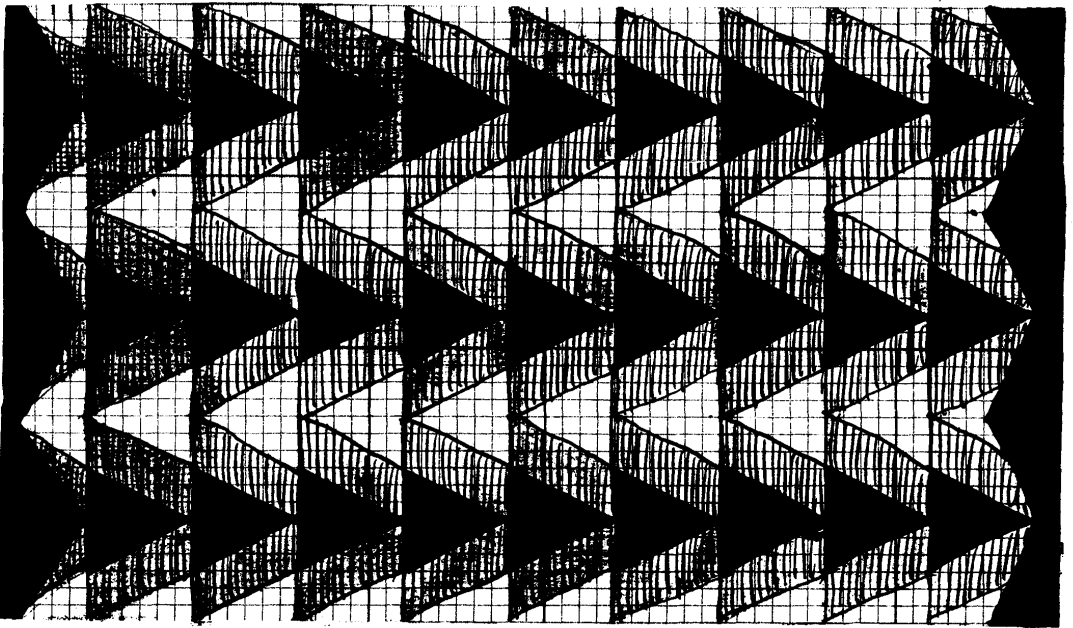

No. 2

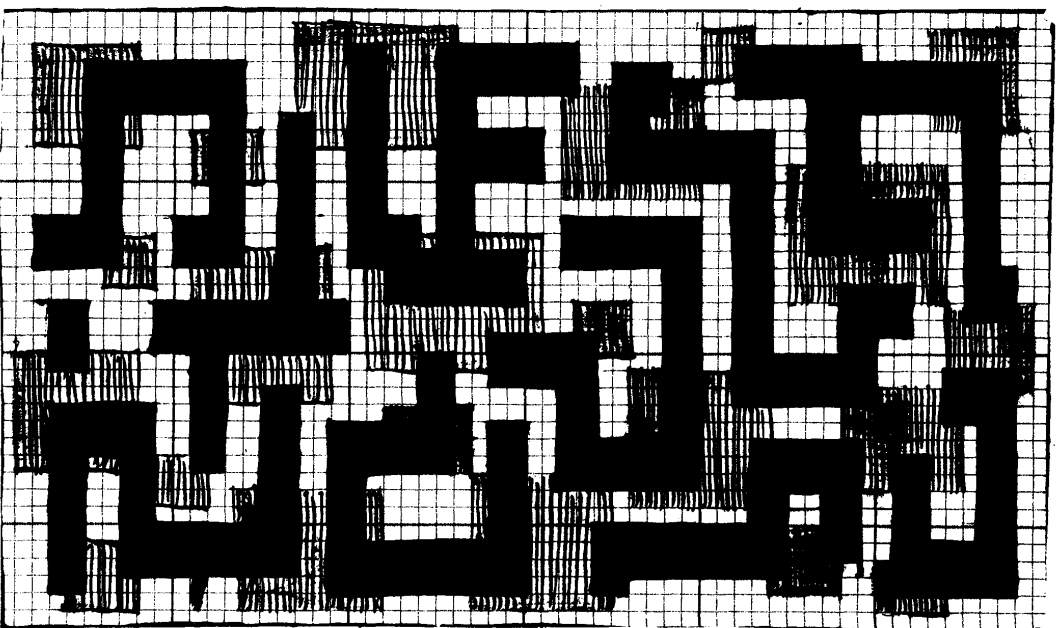

No. 3

Three Patterns for tufted or "file" Weaving

Mary M. Atwater
Helena, Montana, 1930

SHUTTLE-CRAFT BULLETIN

May, 1930

Owing to the closing of the Cambridge office and to various complications, the Bulletin this month is forced to appear without its familiar blue coat, but I dare say this will cause no inconvenience. More annoying is the fact that the diagram could not be finished in time and will have to be omitted, and the new pattern will have to be taken on faith. It is, however, a very charming and unusual pattern and will-- I think -- please anyone who decides to use it.

The pattern is a new development in the crackle weave and quite different from anything we have had before; it is more conservative than the modernistic patterns we have had previously and will not prove alarming to those who prefer the strictly conventional; but it has a style all its own and will go well for modern things. Directions will be given for varying the draft to make it bizarre and ultra-modern if desired.

I am calling it "The Garden Wall" pattern for the sake of having a tag to remember it by.

The pattern consists of two similar figures made up of alternating blocks on opposites, separated by "twill" figures. The effect when treadled as given in the notes is to weave blocks over one figure and a solid "log-cabin" effect over the other figure.

As the weave has much the texture of summer and winter weaving the materials should be carefully chosen or the figures will not come out square. The materials in the piece now on my loom are: Egyptian warp, 24/3, set at 30 to the inch; pattern weft, strand silk in deep plum color; tabby #20 perle cotton in old gold. Fabric yarn might be used in place of the strand silk, or "weaving special" or homespun, or any other of the finer yarns. For heavier materials a wider spacing of the warp is advisable.

The effect is best if one color only is used for the pattern weft. If two colors are used, these should be as closely as possible of the same "value."

THE GARDEN WALL PATTERN

Draft,

1,2,3,4, repeated four times	- - - - -	16 threads
3,2,3,4,1,4,3,4,1,2,1,4,1,2,3,2,1,2,3,4,3,2,3,4	----	24 "
1,2,1,4, repeated five times	-----	20 "
3,2,3,4, " five "	-----	20 "
1,2,1,4, " five "	-----	20 "
3,2,3,4, " five "	-----	20 "
1,2,1,4,1,2,3,2,1,2,3,4,3,2,3,4,1,4,3,4,1,2,1,4	- -	24 "
1,2,3,4, repeated three times	-- -- --	12 "
1,2,3,4,1,2,3,4,3,2,3,4,1,4,3,4,1,2,1,4,1,2,3,2,1,2,3	-	27 "
4,1,4,3, repeated five times	-----	20 "
2,1,2,3, " five "	-----	20 "
4,1,4,3, " five "	-----	20 "
2,1,2,3, " five "	-----	20 "
4,1,4,3,4,1,2,1,4,1,2,3,2,1,2,3,4,3,2,3,4,1,4,3,4	- -	25 "
		288

To put this draft on the Structo loom thread two complete repeats, and thread the last threads: 1,2,3,4, repeated four times.

To weave, treadle as follows, single shots being thrown on each shed, with tabby between shots. The treadeling is written as for our regular treadle loom tie-up, and should be transposed for the Structo loom, "1" being read 3-4; "2", 1-4; "3", 1-2; "4", 2-3.

The pattern and fabric are exactly the same on both sides.

Treadeling for the "Garden Wall" pattern

- (a) treadles 1,2,3,4, one shot each; repeat three times, or weave treadles 1 and 3 alternately, four or five repeats.
- (b) treadles 1,2,3,2,3,4,3,4,1,4,1,2,1,2,3,2,3, one shot each.
- (c) treadles 4 and 1 alternately, -- repeat six times or till blocks are square.
- (d) treadles 3 and 2 alternately, -- repeat six times.
- (c) treadles 4 and 1 alternately, -- repeat six times.
- (d) treadles 3 and 2 alternately, -- repeat six times.
- (e) treadles 3,4,1,4,1,2,1,2,3,2,3,4,3,4,1,4
- (a) treadles 1,2,3,4, repeat three times.
- (f) treadles 1,2,1,2,3,2,3,3,4,3,4,1,4,1,2,1,2,3
- (g) treadles 4 and 3 alternately, -- repeat six times.

- (h) treadles 1 and 2 alternately -- repeat six times
- (g) treadles 4 and 3 alternately -- repeat six times
- (h) treadles 1 and 2 alternately -- repeat six times
- (i) treadles 3,4,3,4,1,4,1,2,1,2,3,2,3,4,3,4,

Repeat from the beginning.

A variation of the draft as follows gives an excellent pattern for sweaters, scarves, or coat-material. For scarves warp in "Afghan" yarn set at about twenty of the inch and weave lightly using the same yarn for weft, both for pattern and tabby. Or the tabby might be of silk. For light weight sweaters the same materials may be used. For a heavier sweater warp in Fabri yarn, at 20 to the inch, use fabri for tabby and shetland for pattern weft. For coat-material the same yarns may be used, but the warp should be set a little closer in order to give a firmer fabric.

Draft B, variation of the "Garden Wall" threading

- 1,2,3,4, repeated six times
 - 1,2,1,4, repeated five times -- or more often if a large figure is desired
 - 3,2,3,4, repeated five times or more
 - 1,2,1,4, " five " " "
 - 3,2,3,4, " five " " "
 - 1,2,3,4, repeated six times (last thread omitted on last repeat)
 - 4,1,4,3, repeated five times or more
 - 2,1,2,3, " five " " "
 - 4,1,4,3, " five " " "
 - 2,1,2,3, " five " " "
- 4 Then repeat from the beginning.

Weave accordingly. That is, omit from the treadeling as given the features lettered (b), (e), (f) and (i)

C. To produce a more modernistic effect in this draft, vary the size and number of the blocks in each figure. Each figure in a very wide warp set with eight or nine figures could be different if desired. The four similar blocks of which each figure of the draft A is composed are the groups of four threads repeated five times each. Suppose one threaded the first figure with two blocks only, the first as written and the second of seven repeats instead of five. The next figure might have four blocks, all different in size, and so on. The weaving should follow the draft, squaring the blocks along a diagonal, but using the manner of treadeling as given. The effect of this method of using the pattern would be very interesting for hangings.

An interesting way to use this draft for linens -- a luncheon set, for instance -- would be as follows:

Draft D, variation of the "Garden Wall" pattern.

1,2,3,4, repeat six times.
1,2,1,4, repeat five times or more
3,2,3,4, repeat five times or more
Repeat the second and third blocks above as many times as desired for a border.

1,2,3,4, repeat six times. (omit last thread on last repeat)
4,1,4,3, repeat five times or more
2,1,2,3, " five " " "
Repeat the last two blocks as desired for the center of the piece.

1,2,3,4, repeat six times.
Repeat border.

Treadle:

treadles 1,2,3,4, one shot each, repeated six times
treadles 4 and 1 alternately, repeat six times or more
" 3 and 2 alternately, " six " " "
Repeat the last two blocks as required for the border
treadles 1,2,3,4, one shot each, repeat six times
" 3 and 4, alternately, repeat six times or more
" 2 and 1, " " six " " "
Repeat last two blocks as required for center of piece. Repeat border.

This will produce a pattern of squares for the center with a border in log-cabin effect. This can be reversed by weaving the last two blocks for the border and the other two blocks for the center. The borders will then be in blocks and the center in log-cabin effect.



Any of the four-block patterns on opposites shown on page 199 of the weaving book may be drafted for weaving in this new fashion. The draft below is for the "Doors and Windows" pattern, No. 132.

Threading Draft E, Doors and Windows in Crackle weave

1,2,3,2,1,2,3,2,1,4,3,4,1,4,3,4, -- repeat seven times. 112 threads
1,2,3,2,1,2,3,2, 8 "
1,4,1,2, repeat six times. 24 "
3,4,3,2, repeat six times. 24 "
1,4,1,2, repeat six times. 22 "
On last repeat omit the last two threads (1,2) and repeat 190 "
from the beginning.

Treadeling, Doors and Windows.

Treadles, 1,2,1,2,1,2,1,3,4,3,4,3,4,3. Repeat seven times.
" 1,2,1,2,1,2,1
" 4 and 1 alternately, repeat about eight times.
" 3 and 2 alternately, repeat about eight times.
" 4 and 1 alternately, repeat about eight times.

- - - - -

In a recent Bulletin a letter was published giving the address of Frank and Bryce. Ltd. of Toronto, Canada as American agents for the Knox linen threads. It appears that this firm does not carry the threads in which we are interested. I am sorry for this error which has caused some unnecessary correspondence. The Knox threads are very beautiful, but apparently, if we want them we shall have to arrange to import them direct.

- - - - -

The travelling collection of modernistic weaving has completed its wide circle, and to judge from the letters received has been of interest to those who participated.

I believe we can make wider use of this travelling exhibit idea, and that those of our members particularly who live far from other weavers will benefit by seeing a collection of different kinds of work. I plan, therefore, to start another exhibit, probably some time during the summer. This will not be limited to modernistic work, though pieces in this style will be acceptable. Will those who think they would like to participate please send me their names, and state what article or articles they will be prepared to contribute.

- - - - -

For the present all mail should be addressed to me personally at Room 2, Empson Block, Helena, Montana.

Mary M. Atwater.

THE SHUTTLE-CRAFT BULLETIN

June, 1930

The more I experiment with the crackle weave, the more interesting it appears. The fabric produced is closely woven, without long skips, and has a very pleasing texture. And, too, as blocks are not limited in size as in overshot weaving, it gives the four-harness weaver many of the pattern possibilities of the six-harness summer and winter weave.

Writing drafts for this weave is, however, not easy -- there are certain quite special complications. I am therefore going to try this month to explain the manner of making these drafts so that Guild members will be able to "write their own," and I shall be glad to criticize drafts sent in to me by members.

There are in the crackle weave four pattern blocks as in overshot weaving, but each block is written on three harnesses -- as in summer and winter weave. Taking the draft at (a) of the diagram, which gives a plain twill succession of blocks, we find that the first block -- block A -- is written: 1,2,3,2. Block B is written: 3,4,3,2. Block C is written: 1,4,3,4. Block D is written: 1,4,1,2. This is simple enough, but when we begin to put even this simple draft down on paper we find that extra threads must be added here and there to preserve the correct movement of the weave. This is similar to the insertion of an extra thread on "return" blocks in overshot weaving. A study of the draft at (a) shows two extra threads between blocks A and B and between blocks B and C. No extra threads are required between blocks C and D and between blocks D and A when the pattern starts over. It will be observed that these extra threads do not actually make the first two blocks larger than the last two as might be expected -- the blocks overlap and each block actually weaves across six threads.

The peculiarity of the weave is that each block may be woven on either of two sheds, and that each shed weaves two blocks at the same time. This gives the overlapping effect that is a characteristic of this weave. It is an interesting effect when well designed, but makes some patterns impossible to produce in this weave.

The patterns in the crackle weave that we have been using are most of them based on the plain twill as shown in draft (a). The "Three Twills" pattern, for instance, is made up of six repeats of the 1,2,3,4 twill, two repeats of draft (a), one repeat of draft (a) with the blocks much larger, and two repeats of draft (a). The "Wild Waves" pattern

and the "Drifting Shadows" pattern are simple variations of the twill, and the "Palm" pattern is similar. In all of these drafts the overlapping feature of the weave is made the chief feature of the design.

At (b) of the diagram is given a simple pattern in crackle weave in which two blocks overlap while the third block does not overlap. This effect is produced by using three blocks only in the draft. A study of the draft and the design as given on the diagram will make this clear. The pattern should be woven as follows: (on the standard tie-up)

treadle 1,	18 or 20 shots
"	4, 8 shots
"	3, 8 "
"	4, 2 "
"	3, 8 "
"	4, 2 "
"	3, 8 "
"	4, 8 "

Repeat

The treadling should be transposed for use on the Structo loom: for "treadle 1", read: levers 3&4
 " "treadle 2", " levers 1&4
 " "treadle 3", " levers 1&2
 " "treadle 4", " levers 2&3

The manner of using the crackle weave described above is fairly familiar to the Guild -- we will call this Crackle Weave I. There is an entirely different set of effects possible in this weave, that I have lately discovered, and this we will call Crackle Weave II. As far as I know, this particular thing has never been done before in hand-weaving and it gives me pleasure to pass it on to our membership.

The order of succession of the blocks in this weave is shown at (c) of the diagram. It will be noted that the second block is the "opposite" of the first block, and that the third and fourth blocks are "opposite" to each other. By using the blocks in opposite pairs any pattern of four blocks that is composed of two two-block figures may be written. If woven as indicated below the effect of one of these patterns is to produce a figure in summer and winter weave against a half-tone background in the "log cabin" effect. The photograph on the bottom of the diagram shows the effect.

The Garden Wall pattern sent out with last month's Bulletin has one figure in weave I and the other figure in weave II. The draft of this pattern, set down in proper fashion, appears at (d) of the diagram. (Note that the fourth thread of the ninth line of the draft as given last month was through a misprint given as a 4 when it should have been a 2.)

Draft (e) is for a large and handsome pattern, suitable for many uses. As both sides of the fabric are exactly the same it is particularly good for hangings, couch blankets or coverlets. It is also fine for pillow-tops. The illustration shows the figure clearly enough. It will perhaps be recognized as the pattern -- slightly modified -- shown at draft 201 in the weaving book.

To put this pattern on the 590 threads of the Structo loom thread first a selvage: 3,4,1,2,3,4 - - - - - 6 threads
 Now begin with thread 33 and thread to the end -- 528 "
 Thread the first 50 threads of the draft - - - - - 50
 Selvage 6
590

Weave pattern (e) as follows:

treadles 1 and 2 alternately for four shots
 " 4 " 3 " " " "
 " 1 " 4 " " " "
 2 " 3, -- four shots
 1 " 4 -- four shots
 treadle 1
 treadles 3 and 4, -- four shots
 " 2 " 1, -- four shots
 " 3 " 2 -- four shots
 " 4 " 1, -- four shots
 " 3 " 2, -- four shots
 " 3
 " 1 and 2, -- four shots
 " 4 " 3, -- four shots
 " 1 " 4, -- six shots
 " 2 " 3 -- six shots
 " 1 " 4, -- six shots
 " 2 " 3, -- six shots
 " 1 " 4, -- six shots
 treadle 1
 treadles 3 and 4, -- ten shots
 " 2 " 1, -- four shots
 " 3 " 4, -- four shots
 " 2 " 1, -- thirty shots or more
 " 3 " 4, -- four shots
 " 2 " 1, -- four shots
 " 3 " 4, -- ten shots
 " 3
 " 1 and 4, -- six shots
 " 2 " 3, -- six shots
 " 1 " 4, -- six shots
 " 2 " 3, -- six shots
 " 1 " 4, -- six shots
 " 1
 " 3 and 4, -- four shots
 " 2 " 1, -- four shots

treadles 3 and 2, -- four shots
 " 4 " 1, -- four shots
 " 3 " 2, -- four shots
 " 3
 " 1 and 2, -- four shots
 " 4 " 3, -- four shots
 " 1 " 4, -- four shots
 " 2 " 3, -- four shots
 " 1 " 4, -- four shots
 treadle 1
 treadles 3 and 4, -- four shots
 " 2 " 1, -- four shots
 " 3 " 2, -- six shots
 " 4 " 1, -- six shots
 " 3 " 2, -- six shots
 " 4 " 1, -- six shots
 " 3 " 2, -- six shots
 treadle 3
 treadles 1 and 2, -- ten shots
 " 4 " 3, four shots
 " 1 " 2, -- four shots
 " 4 " 3, -- thirty shots or more
 " 1 " 2, -- four shots
 " 4 " 3, -- four shots
 " 1 " 2, -- ten shots
 treadle 1
 treadles 3 and 2, -- six shots
 " 4 " 1, -- six shots
 " 3 " 2, -- six shots
 " 4 " 1, -- six shots
 " 3 " 2, -- six shots
 treadle 3
 Repeat from the beginning

- - - - -

I have a notice from the postoffice requesting me to draw the attention of correspondents to the postal regulation that forbids the inclosing of written matter in parcels post shipments. If writing is enclosed the entire shipment is subject to first class rates. Written matter should be sent in an accompanying letter, either mailed seperately or attached to the outside of the parcel. Drawings when there are notations of any kind on them must be sent by first class mail and should not be enclosed in a parcel with woven pieces and sent parcels post, as sometimes happens.

- - - - -

One of our Guild members, Miss Lillie Ives, whose address is 301 West Evans Street, Florence, South carolina, wishes to hear from members who have hand-woven

June 1930 - 5

articles for sale that they can supply her on consignment for her shop. I suggest that it would be well to write Miss Ives for further information before sending articles. I do not know what she most wants -- whether rugs or towels, dresses or pillow-tops.

- - - - -

I have asked Mr. Bernat of the Emil Bernat and Sons Co., Jamaica Plain, Massachusetts, to stock cards for card-weaving, so orders for this material should be sent to him.

- - - - -

When Mrs. Norrington left Cambridge so suddenly she left a good many things at a loose end. It is very difficult for me, who am so far away, to get everything set straight, but I am most anxious to do so and wish any member of our circle who has a complaint to make would write me immediately. Mrs. Norrington's affairs are in the hands of her attorney, Mr. John T. Comerford, 19 Congress Street, Boston, Massachusetts, who is also busy trying to settle matters. Guild members will realize my difficulty in taking up the office work of the Guild at a moment's notice and without either the equipment or the records of the Cambridge office, and will -- I am sure -- exercise what patience may be needed till things are running smoothly again.

The Bulletin is not as handsome without its blue cover, but I shall eliminate the cover and mail it by first class mail. I think in this way the service will be more certain, -- and the cover, after all, is not very essential.

- - - - -

Knox linens once more: The Canadian agents for Knox threads, after informing us that they could not supply these threads for weaving, now send out samples and prices of several weaving threads. These are specially imported and there is a delay of from six to eight weeks in filling orders. The material is also subject to a 30% tariff on coming into the United States, which brings the price close to the prices of the linens we have been using. Anyone wishing further information should write to Frank and Bryce, Ltd., 177 Wellington Street West, Toronto, Canada.

- - - - - Mary M. Atwater-
Helena, Mont.

The Crackle Weave

Shuttle-Craft Bulletin for June 1930

Crackle Weave I

Twill arrangement of blocks

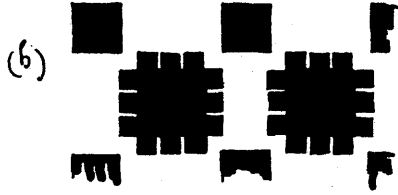
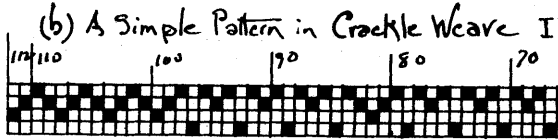
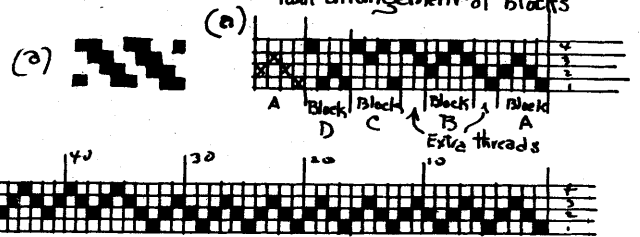

Crackle Weave II

Twill arrangement of blocks

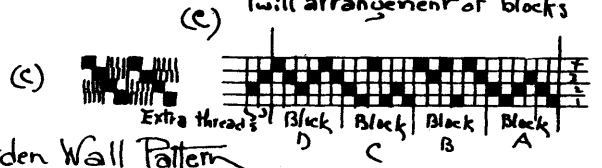

d. The Garden Wall Pattern

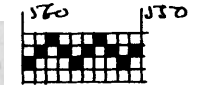
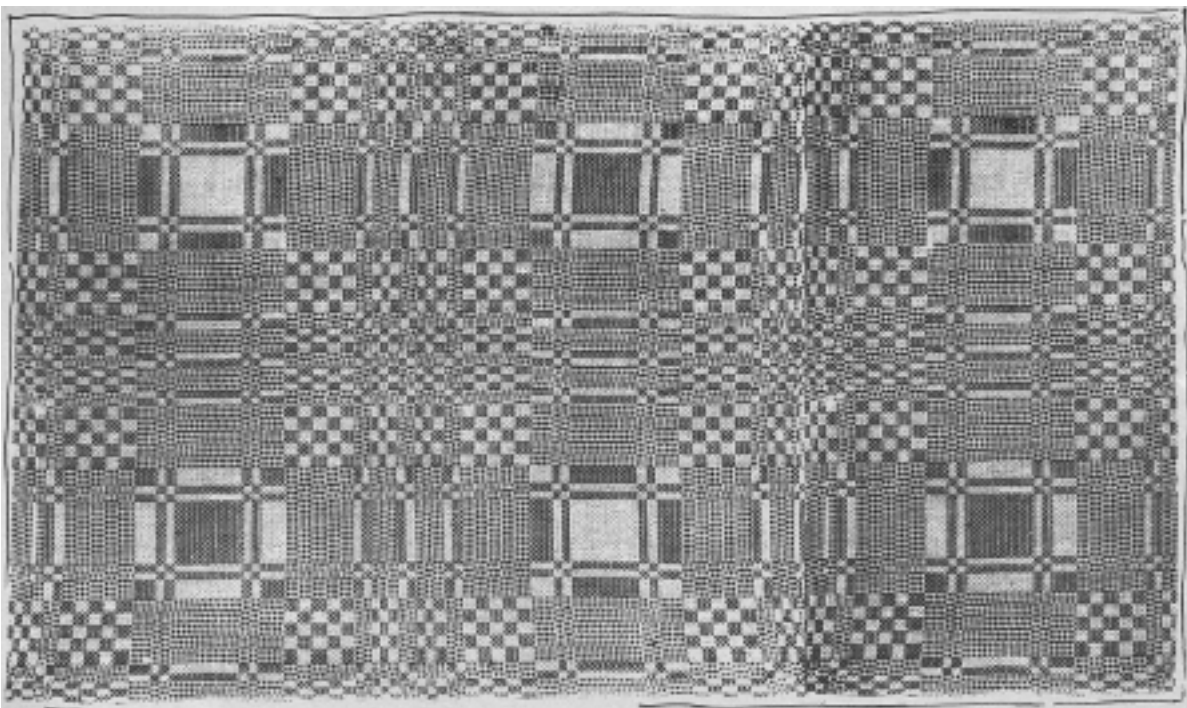
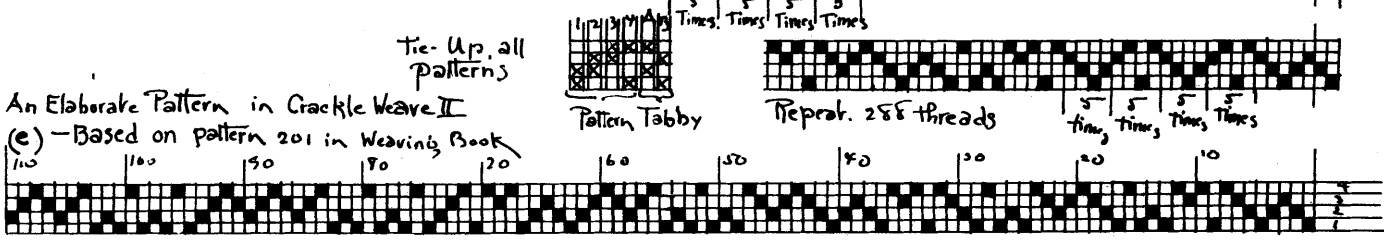

Pattern (e)

SHUTTLE-CRAFT BULLETIN

July, 1930

Light-weight wool fabrics for scarves, sweaters and dresses are particularly interesting at this season, and I feel sure the members of the Guild will enjoy the letter of one of our members from California. She sends two very attractive samples and writes as follows:

"The material of sample number one is very lovely for this climate," (it would also be ideal for late summer on the eastern sea-board or by the lakes -- anywhere where there is dampness in the air and wool is pleasant.) "It seems rather sleazy but it wears like iron. The warp is Afghan yarn sleyed twenty to the inch, and the weft is Kashmir yarn beaten about twenty to the inch for the plain part of the fabric and about thirty-five to the inch for the trimming. The threading is twill and the main part is woven in tabby weave. The trimming is woven: harness 1 alone; 2 alone; 3, alone; 4, alone; repeat. " (This is a 3-1 twill. The herring-bone threading might be used, woven in the same way.)

"One must allow at least five inches to the yard in width for shrinkage; and then use the utmost care in weaving. Shuttle-bobbins should be wound by hand; shuttles wound by machine cause the material to shrink terribly -- because the Kashmir yarn is so very elastic, I suppose. The warp shrinks only about three inches to the yard. I weave this material with a very loose tension -- as loose as I can work it. In white it is lovely for baby things.

"For a slightly heavier fabric I use Afghan yarn for weft as well as for warp, at twenty to the inch each way."

The samples sent were plain white material with narrow stripes in the twill weave for trimming. The effect was charming. This same weave might be used for scarves, and for filmy sweaters to wear over dainty summer dresses.

Iceland yarn set at fifteen to the inch and woven in the same material is very soft and lovely. This particular yarn cannot be had of the Bernat company, but may be purchased from the Shepherd Worsted Mills, Newton, Massachusetts. It is expensive, and comes only in balls, which is a nuisance, but the fabric made of it is charming.

Light scarves in squares and stripes of many brilliant colors appear still to be the vogue, and are pleasant to make. The weave is usually plain tabby, though narrow stripes in twill weaving can be put in at intervals and on the ends.

July, 1930 - 2 -

Bernat's "weaving special" yarn is sometimes used for scarves, but seems to me too harsh. I believe the "English crewel" yarns would be better, though I have not myself used them for the purpose. These yarns may be had in two hundred different shades, so that practically any color-scheme is possible.

Plain-weave scarves depend on color and texture for their effect, and great pains must be taken with the beat, which must be light and even.

Some two years ago directions were given in the Bulletin for light-weight wool fabrics done in the openwork weave. As we have many Guild members who were not with us so long ago it may be useful to repeat this matter here. For dress-fabrics Fabri yarn may be used, set at twenty to the inch and woven the same. Afghan yarn set at twenty-four to the inch and woven the same makes a finer, softer fabric. Saxony yarn set at fifteen to the inch makes a good fabric for light sweaters.

The openwork threading in its simplest form is as follows: ~~xxx~~ 1,2,1,2,1,4 repeated four times
(1,4,1,4,1,4, as many times as desired for plain weaving between figures, or may be omitted.)
3,4,3,4,1,4, repeated four times
Plain as above

The tie-up may be made to four treadsles: treadle 1 tied to harnesses 1,2 and 3; treadle 2 tied to harnesses 2 and 4; treadle 3 tied to harnesses 2,3, and 4; treadle 4 tied to harnesses 1 and 3;. Weave as follows:

First figure: treadles 2,1,2,1,2,4, repeated four times
plain, if woven, 2,4,2,4,, etc, ending on 2

Second figure: treadles 4,3,4,3,4,2; repeated four times
plain; if woven, 4,2,4,2 etc, ending on 4

The effect of this pattern woven in this manner is squares of openwork and plain tabby. If the treadeling of either figure is repeated all the way the effect will be stripes of openwork and plain tabby. A border in plain weaving may be made all around an openwork piece by threading the desired width; 1,4,1,4 etc., repeated as desired.

For a small openwork figure thread:
1,2,1,2,1,4,3,4,3,4 and repeat

For wide, light-weight woolen shawls, this weave may be used in many different ways. A design made for the first issue of the Handicrafter, -- February 1928 -- had the small figure for the center and corners in a five-spot arrangement of

the two large figures. Any two-block pattern may be developed in this weaving, using the first figure for one block and the second figure for the other. The blocks may, of course, be any size desired. For curtains these arrangements are very attractive. For dress-material, however, the threading as given first is the best for most things, -- the open-work effect being woven for borders and the rest of the piece in plain weaving. Worked out in white this is lovely. It is also handsome in two colors, one color in the warp and one in the weft. I made a beautiful piece once that was warped in a brilliant purple and woven in vivid red. Blue warp with green weft is good, and blue and tan are good together, and so are brown and burnt orange. Often two colors that seem very inharmonious make a beautiful effect when woven together in the plain weave or such a weave as this.

- - - - -

I have often intended to say something in the Bulletin about crepe. The crinkly effect of crepe, when woven in fine, soft wools, is very attractive. There are several methods in use for the commercial manufacture of creped fabrics, -- some entirely in the finishing of the fabric which is treated with chemicals and otherwise manipulated. The best way, -- for the hand-weaver at least -- is to use yarns some of which have a right-hand twist and some a left-hand twist. To produce crepe both yarns should be used in the warp and also in the weft. It is the custom to ~~think~~ lightly one of the yarns so that no mistake will be made in arranging the threads, which should follow some definite arrangement, as: six threads right hand twist, two threads left hand twist, two right hand, six left hand, two right, six left and repeat. The weaving should follow the same plan. The crinkled effect develops when the material is washed.

- - - - -

A few words about finishing all-wool fabrics. Hand-woven wool fabrics do not need an elaborate finishing process, -- all they require is to be well washed in luke-warm soap-suds and lightly pressed with an iron. But they do need this. A wool piece is improved by washing almost as much as a piece of linen. The pattern in the openwork weave does not show till the piece is washed, and in any wool fabric the texture of a washed piece is much softer and at the same time firmer than the unwashed. Of course the soap used should be a mild soap, entirely free of lye and the water used should be neither hot nor cold.

- - - - -

July, 1930 - 4 -

A few words about the Bulletin -- the Bulletin is not nor ever has been, a magazine in any conventional sense. It is, -- what we have always called it -- a monthly news-letter prepared for our special group of weavers, the idea being to supply the particular information requested by members, to give seasonal suggestions, and to supply new ideas. A magazine prepared for general circulation cannot possibly give the same sort of service.

We have, during the five years or so of the Guild's existence done some quite interesting things. Take, for instance, our new "crackle" weave. The first pattern in this weave appeared in the Bulletin a year and a half ago. It is an old weave, but till that time very little used, and apparently never used except in the Diamond pattern and one or two other very simple designs. The adaptation of this weave to "modernistic" effects is entirely our own, and so are the more or less elaborate patterns that have appeared from time to time in the Bulletin, including the entirely new adaptation of this weave given in the last issue. But already the new weave has gone over into general practise. I have seen several magazine articles of late that mention the weave and show various uses of it, and though no credit was given to the source of the inspiration it is splendid to realize that we have made a very definite contribution to our beautiful craft. The experimental work has for the most part been mine, but without the support of the Guild membership that makes the Bulletin possible, the discovery would not have become current knowledge. I want all the members to feel that in this little triumph each of us has a share. We are doing new things first, -- blazing new trails -- and that seems to me pretty good fun.

- - - - -

Speaking of magazine articles, many Guild members have no doubt read with interest Mr. Hall's plea for the fly-shuttle loom, published in the last issue of the Handicrafter. I have prepared a reply to Mr. Hall which the editor of the Handicrafter tells me he will print soon.

Miss Anna Hall, who is one of our members, asks me in a recent letter to make it clear that in the Hall loom the fly-shuttle is thrown by hand. I do not altogether understand this statement, as by definition a "fly-shuttle" is a shuttle thrown by a mechanism operated by a cord and a handle. If the shuttle is thrown by hand it ceases to be a fly-shuttle at all. I have written to her for further light on the subject, but her answer has not come in time to be included in these notes. Definitions appear to be what we need. Language is a tricky thing sometimes, and two people may dispute furiously to find in the end that they both mean the same thing. However from Mr. Hall's mention of shuttle-boxes and other details I believe he had a true fly-shuttle in mind in his argument.

- - - - -

July, 1930 - 5 -

Speaking further of magazine articles: I have been preparing a new series for the Handicrafter, the first of which articles will appear in the forth-coming July-August issue. The series is devoted to two-harness weaving, and will, I believe, prove of considerable interest to the craft. The first article is general, and gives also some notes on tapestry and Oriental rug-making. The second article of the series describes in detail some of the interesting weft-face fabrics in this weave; a third article will be devoted to warp-face weaves and patterns, and the fourth and last will discuss "50-50" fabrics. It has long seemed to me that the possibilities of two-harness weaving were being neglected, and this series aims to give information that is not generally available.

- - - - -

Our new members, of course, are all using the weaving book published a year and a half ago, and most of the old members have availed themselves of the special price to the Guild and are using it, too. If there are any who plan to purchase the book soon I suggest that they get their orders in before the first of September, as the special price will be discontinued after that. The regular price of the book is \$6.50, plus postage, and the special price to the Guild has been a dollar less.

- - - - -

Miss Lillian Fliege, one of our members, is leaving Cincinnati where she has been living and wishes to dispose of her Shuttle-Craft Practical loom, with its spool-rack and rug-shuttles, all in good order. The loom is in Cincinnati. Anyone interested may address Miss Fliege at 1107 Calumet Avenue, Calumet, Michigan.

- - - - -

Several Guild members have written me recently about contrivances designed to make easier the handling of a large number of shuttles on a small loom. The problem has arisen due to our modernistic weaving in which many colors are combined. Captain W.J.Rix, Veterans' Hospital 104, San Fernando, California, -- who is a Guild member -- writes that he has been experimenting with a detachable shelf designed for the Structo loom. I have not myself seen the contrivance but from the description I believe it to be a practical and convenient thing. Captain Rix states that he will be able to supply the shelf at \$2.50, and I suggest that any Structo weaver who suffers from shuttle-complexity write him for particulars. Possibly the contrivance could also be made to fit the little MacKay "parlor" loom.

July, 1930 - 6 -

And now about the new travelling collection: Will those who plan to participate please let me know as soon as possible what they intend to send. Articles for the exhibit should reach me by the fifteenth of August to be included. This exhibit will not be limited to modernistic weaving but will include as many different types as possible.

Owing to the time required for the exhibit to make the rounds, it will be impossible to send it to anyone who does not contribute.

Finished articles will be especially acceptable, though we also want statches of samples. Each piece or set of samples should be marked with a tag bearing the weaver's name and address, and also any special information that may seem desirable, -- such as name of weave and pattern, materials and setting in the reed. It is sometimes difficult to work out these particulars from an inspection of the piece. Return postage should accompany articles sent for the exhibit and any pieces found unavailable will be returned at once. Accepted pieces cannot be returned till the circuit has been completed, which requires a number of weeks.

- - - - -

For the convenience of new weavers I am preparing a collection that will constitute a permanent exhibit and that can be sent out as a loan-collection on the payment of a fee. There will probably be two such collections -- one designed for beginners, and one planned for those who are experimenting with the more elaborate weaves on six and eight harnesses. Each piece will be accompanied by complete notes, and as great a variety of weaves and patterns combinations of materials and color-schemes, will be brought together. The fee, I think, will be five dollars and the carriage charges, and a two-week study period will be allowed. If desired, the collection may be kept longer than two weeks at a dollar a week rental for the additional time.

It has come to my attention that Mrs. Norrington who conducted the Cambridge office of the Shuttle-Craft Co. has gone into the business of selling handwoven articles on consignment. I wish to notify Guild members that she has left the company, and that neither the company nor I personally can be held responsible on account of business transactions you may come to have with her.

As Mrs. Norrington's contact with the weaving public has come about through her association with me, I feel it my duty to make this statement. One complaint has already reached me from a Guild member who supplied Mrs. Norrington with a coverlet some months ago. The coverlet has been sold but the weaver is unable to get her money.

May M. Atwater

SHUTTLE-CRAFT BULLETIN
for
August, 1930

Before discussing the new patterns for this month I want to remind Guild members of the travelling exhibition. Many charming pieces have already come in -- things that I am sure everybody will want to see. Only those who make a contribution to the collection can be included in the itinerary, so send in something, and send it as soon as possible. Things received after the middle of August cannot be included. The twentieth will be the final closing date for entries. We want finished pieces, but samples will also be acceptable. This is an exhibit for weavers, and a mere scrap that shows some unusual combination of colors or materials may prove of as much interest as an elaborate finished piece. It is, I think, always interesting and stimulating to see the work of others, and this will give a fine opportunity to share ideas and experience.

Each piece sent in for the exhibit should be tagged with the weaver's name and address, and also with such notes as would be valuable -- name of pattern, warp and weft used, setting in the reed, etc., etc.

Parcels should be sent to me at Basin, Montana. I shall get them if they are sent to Helena, but there will be delay. My two addresses cause some confusion: my business office is in Helena, and I live in town from October to May, and in Basin during the summer.

- - - - -

A letter from Mr. Hall, together with a letter from Miss Hall, makes it perfectly clear that the fly-shuttle controversy turns -- as suggested last month -- on a definition. Mr. Hall's looms, it appears, are not "fly-shuttle" looms at all, in the ordinary sense of the term. Mr. Hall uses a large throw-shuttle, similar to the shuttles used on mechanical looms, but throws the shuttle by hand. The special feature of the loom is an extended shuttle-race or shelf to catch the shuttles, with a pad against which they rebound.

It seems to me a pity that all this was not made clear in the article published in the Handicrafter, for undoubtedly most readers took the article as a plea for mechanical

August - 2 -

weaving, which -- it now appears -- was not the intention at all. This is unfortunate, as it adds to the confusion in the matter. I hope Mr. Hall will correct the impression in a future issue of the Handicrafter.

All hand-weavers are interested in the question of fly-shuttle weaving -- it is really a vital question for our craft. As Guild members know, one of our number has taken the required steps to get a ruling from the Federal Trade Commission at Washington, but the matter appears to drag. If the ruling when it comes should be adverse -- that is, if fabrics woven on mechanical looms are permitted to be advertised and sold as "hand-woven" -- our craft will suffer greatly, and those of us who weave for profit will have to go in for machine weaving. It would be a case of "history repeating itself," for it was the first fly-shuttle looms that sent the old hand-looms into the discard a little more than a century ago.

- - - - -

I want, once more, to say a few words about tie-up. It is amazing, and trying on the disposition, to go about among looms and find so many that are not operating properly, due to faulty tie-up. It is, perhaps, possible to produce a good fabric on a badly adjusted loom, but the waste of time is terrible. A loom should open an ample, clear shed for the passage of the shuttle, -- if it doesn't it should be re-adjusted. It is impossible to adjust a loom unless the "snitch-knot" is used throughout in the tie-up. Anyone who has failed to master the snitch-knot or who has forgotten how it goes should begin by getting this perfectly clear. Start adjusting a loom from the top on the ordinary counterbalanced loom. Make sure first that the cords go around the rollers as they should and that the rollers hang at the right height. Tie the rollers together when you have them in correct position and proceed to level the harnesses. When these are right, tie them together and level the lamms. Finally adjust the treadles, making sure that all cords tied to the same treadle have the same pull. If, after all this, the loom still works unevenly, adjust the knots till the trouble is remedied, no matter how much time it takes.

The best cord for tie-up is a fine, strong linen cord, but this is not always available. Large counterbalanced looms require a much heavier cord than the "jack" loom such as the MacKay loom, and a very fine sash-cord can be used. For the MacKay loom this is too coarse, however, and it is really necessary to use the linen cord such as is made for Jacquard tie-ups.

The tie-up on the MacKay loom is quite different from the tie-up on a counterbalanced loom, and if anyone is having trouble with the adjustment I shall be glad to prescribe the remedy.

Structo weavers are not troubled with the problems of tie-up. The only difficulty that occasionally develops is a tendency for the levers to slip out of the clutch. This may be due to weakness of the spring and can be remedied very easily by purchasing a long spring such as is used on screen doors, and attaching this to the left hand end of the top-castle instead of as the side. If the clutch casting is badly worn it should be replaced, but as a rule many years of active service will not cause enough wear of the teeth to make trouble.

The point is that before trying to weave something beautiful it is necessary to make sure that the weaving equipment functions properly.

- - - - -

The patterns for this month are two new designs in crackle weave. Pattern (a) is a small figure in the original manner of using this weave. It is a good pattern for bags, book-covers, etc., and also for furniture covering. It lends itself well to weaving in two colors, one color being used for all shots on treadle 2, and the other color for the rest of the pattern. The lighter and less interesting of the two colors should be used for the square block as this is the least interesting part of the pattern and serves simply to make a space between the figures.

Though the crackle weave used for a pattern of this type is a new trick in weaving, this pattern is conventional and if woven in a typical Colonial arrangement of colors is perfectly conventional in effect and can be used for covering an old wing chair or an ancient foot-stool.

The warp for chair-covering may be cotton, linen or wool. Mercerized cotton should not be used if one wishes to be strictly Colonial, however. Fabri yarn is the best wool warp to use. The weft may be homespun yarn or Shetland yarn.

A very beautiful fabric for dining room chair-seats may be made of heavy linen floss over a fine linen or mercerized cotton warp with a tabby in linen "weaver." This, of course, is not a "period" fabric but gives a more modern effect. A fabric much used for modernistic effects in chair-covering is a combination of linen and artificial silk. It sounds unpleasant but is often very handsome. Of course the all-linen fabric is more durable.

Heavy "perle" cottons are sometimes used for chair-covering, but though durable these fabrics soon lose their beauty and get a w-freyed and "stuffy" look that is disappointing.

The treadeling for pattern (a) -- on our regular six-treadle tie-up -- is as follows:

treadle No.2,	about 20 shots	(as required for square block)
"	4, 6 or 7 times	
"	3, 6 or 7 "	
"	4, 6 or 7 "	
"	2, 3 times	
"	3, 6 or 7 times	
"	4, 6 or 7 "	
"	3, 6 or 7 "	
"	2, 5 times	
"	4, 6 or 7 "	
"	3, 6 or 7 "	
"	4, 6 or 7 "	

- - - - -

follows:	To put this pattern on the Structo loom thread as	
	Selvage, 3,4,1,2,3,4, - - - - -	6 threads
	complete draft, six times - - - - -	552 "
	from beginning to thread 25 - - - - -	25 "
	selvage, 4,3,2,1,4,3,2 - - - - -	7 "
		<u>590</u>

To weave on the Structo loom transpose the treadeling as usual. For "2", read 1&4; for "3", read 1&2; for "4", read 2&3.

- - - - -

It will be noted that this is a three-block pattern and one of the usual pattern sheds is not used at all.

Of course many variations in the treadeling are possible and will give a number of interesting little patterns. The directions are for producing the effect illustrated on the diagram.

- - - - -

Patterns (b) and (c) are in the new crackle weave technique introduced in the June Bulletin. They are large patterns intended for couch-covers, coverlets, window drapery or rugs. The effect of this weave is very subtle, and the figures do not appear in sharp contrast as shown on the drawing, and one need not fear a too startling and patterny result, though the figures are large and simple.

Pattern (b) may be given a modernistic slant by threading the four large blocks of the figure each a different size, and the sizes of the blocks may be different in each repeat, though the total number of threads in each repeat should remain the same. For instance in the first repeat make the first large block eight threads smaller than as written, the second block sixteen threads larger, the third twelve threads smaller and the fourth four threads larger.

Pattern (b) is a twill arrangement of blocks, and pattern (c) is a large diamond -- like pattern (b) written with a "return." It is surprisingly handsome when woven -- much more

August 1930 - 5 -

effective than one might guess. I once saw a very beautiful old double woven piece in this pattern, with blocks about six inches square.

The first 48 threads of the draft make a good border repeat for either (b) or (c).

Treadle pattern (b) as follows:
treadle 1, treadle 2, alternately for 8 shots
treadle 1
3, and 2, alternately, 4 shots
4 and 1 alternately, 4 shots
"X" 3 and 4 " 9 "
1 and 4 " 4 "
2 and 3 " 4 "
1 and 2 " 31 "
3 and 2 " 30 "
4 and 1 " 30 "
3 and 4 " 31 "
1 and 4 " 4 "
2 and 3 " 4 "

Repeat from the beginning
To weave pattern (c) treadle as above, then repeat the first block -- 1 and 2 alternately for 8 shots. Then beginning at the bottom weave backwards to the point marked "X" -- 3 and 4, eight shots. Reverse at this point and weave downward again.

- - - - -

The silk orders totaled over three hundred pounds. The material is being shipped here by freight and may not be received for another week. I will then sort and apportion it and send it out as soon as possible. Several orders were received late, but I sent for an additional amount of material and if this is sent I shall be able to fill all orders.

There may be a special in cottons to offer the Guild before long.

- - - - -

Our Guild year Begins in October and I am making plans for the work of the coming year and shall be glad to receive suggestions from members. The October number is our Christmas number, of course, with all sorts of suggestions and patterns for making the smaller articles to be made as gifts or for the Christmas sales. And one of the winter numbers is devoted to the always interesting question of coverlets. What other special numbers shall we have? A bag number? A baby-blanket number? Linens? Please let me hear from you.

- - - - -

Mr. Bernat, of the Emil Bernat and Sons Co, Jamaica Plain, Massachusetts, publishers of the Handicrafter, tells me he has a few complete years of back-numbers on hand which he is willing to sell for \$2.00. This in answer to several requests for this information.

Mary M. Atwater

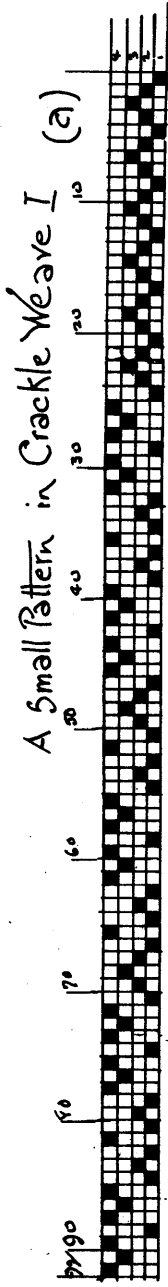
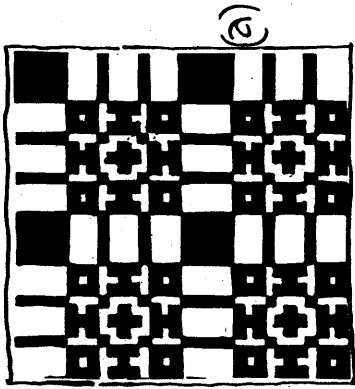

A Large Pattern in Crackle-Weave II

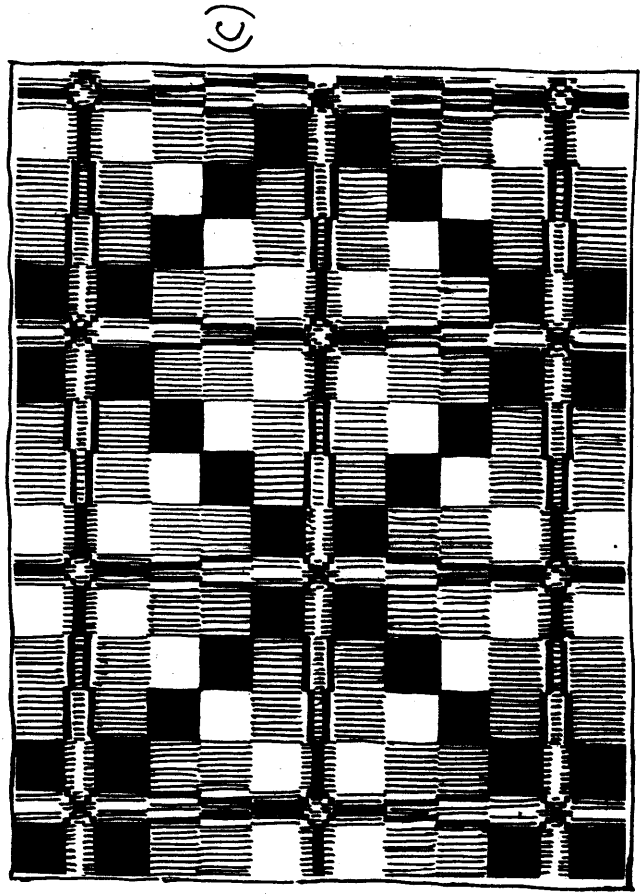
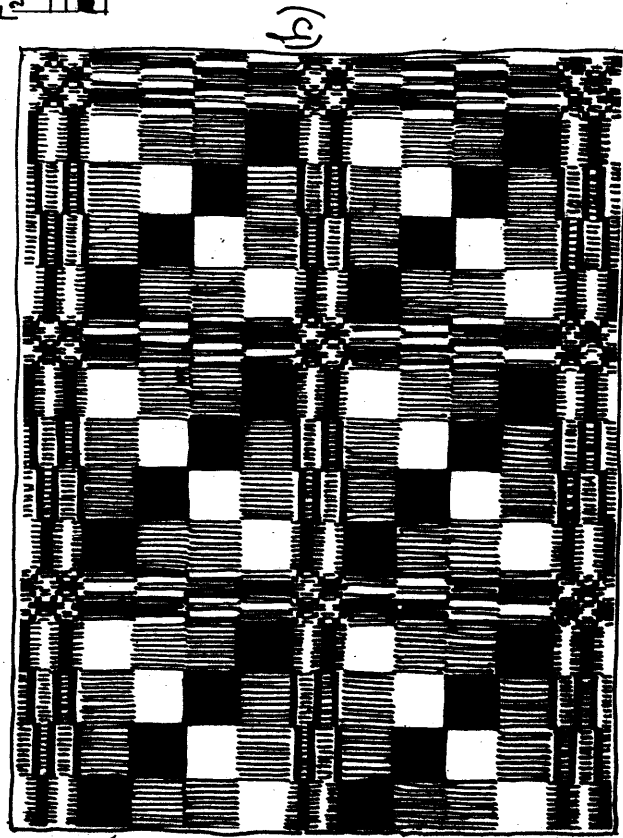
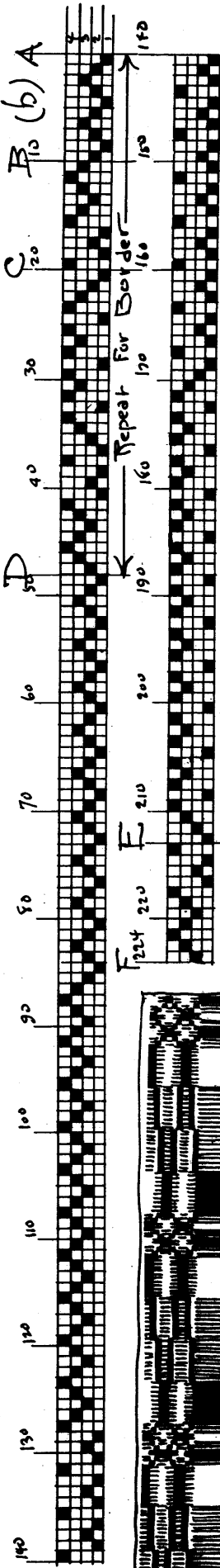

To thread for pattern (c), begin at the point marked "B",
 draft (b), — thread No. 11 — and thread to the end: 214 threads
 then thread from "A" to "C", — — — — — 20
 Beginning at "E" — thread No. 213 — follow the draft
 backwards to "D" ending with thread 48 — — — 166 threads. Total, 400 threads in each repeat.

THE SHUTTLE-CRAFT BULLETIN
for
September, 1930

With this issue the Bulletin rounds out its sixth year. Many members of our Guild have belonged to the circle since the beginning and write me that they have complete files of our ~~unpretentious~~ little leaflet and refer to them constantly. This makes me feel that the Bulletin is accomplishing its aim -- to supply patterns and information that weavers will find useful in their work.

The Bulletin aims, too, to provide a point of contact for weavers in all parts of the country, and accomplishes this in various ways -- through the travelling collections, for instance. The collection that has recently started on its long journey is one of the most interesting that has gone out, and I wish every Guild member might see it. The itinerary, however, is long enough in making the rounds of those who have contributed. There is no reason, though, why another collection should not start on a different round, and I suggest, therefore, that members plan something to send in by the first of January for another exhibit.

I wish to make the February number of the Bulletin an "experience" number, and ask members to send in letters to be included in this issue, contributing some special piece of experience that will be valuable to the circle. I already have several letters I wish to use in this issue, but invite more.

- - - - -

A Guild member wrote me recently, -- after seeing the last issue of the Handicrafter -- and asked whether some of the St. Louis weavers whose beautiful work was shown in this issue were not members of the Guild. It gives me pleasure to say that Miss Lillian Gloser who is the head of this work, and also Miss Ella Jurgens whose beautiful weaving is shown, are both among our original members. Miss Winifred Mitchell, who has made such a shining success -- both artistically and financially -- of the Tenally Weavers, is a Guild member, too; and so are a large majority of those who write for the Handicrafter and whose work has been mentioned from time to time in the "Looking at the Crafts" articles -- Mrs. Johnson, Miss Emily Goodwin, Mrs. Grace Reed, Mr. Roger Millen, Mr. Heartz, Miss Hall, Miss Fetterolf, Miss Winogene Redding who has done such interesting work in one of the mountain communities of the South, Mrs. Pwell of the Dedham Hand-Weavers, Miss Hodgkins -- I wish I could name all. In fact wherever there are exhibitions of handicraft the work of our members is conspicuous. It should be a matter of pride to the whole circle that this is so, and I for one feel a fine thrill when I see my patterns appearing in new and delightful forms.

- - - - -

For the coming year we will have the special Christmas Bulletin next month, with many suggestions for Christmas weaving, -- a special issue devoted to linens in December (in response to several requests for this material) -- our regular

coverlet number in January, and the "experience" number in February. In March we usually have a number devoted to dress-fabrics. Requests for other social material will be received with interest. As far as possible, the Bulletin is written around the requests that come in.

- - - - -

A request for notes on "pick-up" weaving inspired the present issue. It will be remembered by those who have been Guild members since the beginning that notes of this sort came out in the Bulletin some years ago, but the subject is interesting and is well worth taking up again.

This method of weaving does not seem to me altogether legitimate, somehow. It is a trick, a make-shift, rather than a correct technical process. But the results are usually striking and unusual and are often very lovely, -- so why not do it? The work is, of course, much slower than regular weaving. It must be done with extreme nicety or the results are apt to be messy. However, it is neither a difficult or complicated process.

Almost any good pattern may be used for this form of weaving, as illustrated by many of the pieces shown in the July-August Handicrafter. The patterns I have chosen for my diagram are very simple ones, in order to make the process as clear as possible. Moreover, these two patterns give particularly good results, due to the fact that they are "on opposites."

The simplest form of this type of weaving is illustrated at (a) of the diagram, which shows a sketch of a curtain in Monk's Belt pattern, woven with top and bottom borders and with "pick-up" borders along the sides. To make this curtain warp in Egyptian cotton at 24 ends to the inch. Other materials can, of course, be used instead, but this material at this setting produces a handsome scrim fabric with enough -- but not too much -- body. Warp 578 threads, which at this setting gives a width of 24", and makes 13 repeats of the draft with six threads over, which should be threaded: 1,2,3,4,1,2.

Weave ten inches in plain tabby for the bottom hem, being careful not to beat too heavily. Then weave a border 11" wide in any desired variation of the pattern. In weaving this border use a fairly heavy weft, and tabby each way between pattern shots.

To begin the side borders, select carefully the group of warp-threads that constitute the second and twelfth figures. With colored chalk or charcoal or graphite, color two threads on either side of each group, carrying the marking back to the warp-beam. As the warp is woven off these markings should be renewed and carried further back. The object of marking these threads is, of course, to make it easy to bring the shuttles through the warp at the right places. Three shuttles are required -- one carrying the tabby thread and two small shuttles carrying pattern weft, -- one for each border. These small shuttles may be of the flat, "poke-shuttle" type, and may be cut out of stiff cardboard.

The side borders may be woven in any treadling of the pattern that may be preferred, the pattern thread being taken back and forth across the border sections only, and two tabby shots across the entire curtain being woven between pattern shots. If only one tabby shot is used between pattern shots the pattern weft does not always catch as it should along the edges of the border.

Weave in this manner for the length desired. Weave a top border similar to the bottom border, but narrower, and end with six or eight inches of plain tabby.

The same process may be used in weaving a table square with a border on all four sides. There are, however, some drawbacks; either the center will be too open and "slimpy" in texture (not a bad feature in a scrim curtain but less attractive in a table-piece) or else the border sections will pile up in a disagreeable way. I once made what proved to be a very handsome table piece in a manner that overcame these difficulties, and will describe in detail. The piece was woven of "natural" tussah silk with a border in natural and blue; over a fine spun silk warp set at 30 ends to the inch. Other materials and a different setting could, of course, be used. The pattern selected was "Sugarloaf."

Warp 1122 threads, which at 30 to the inch gives a width of a little more than 37" in the reed. Thread a selvage, 1,2,3,4 and then twelve repeats of the pattern. Repeat the first 58 threads of the draft, and thread the last four threads:3,4,1,2 for a selvage.

Weave the bottom border with three shuttles -- one tabby shuttle and two pattern shuttles, one in natural and one in blue. Treadle as follows:
treadle 1, blue; treadle 3, natural. Tabby -- a single tabby this time. Repeat as often as required to square the first block -- about six shots of each color.
The: treadle 3, blue; treadle 1, natural. Tabby. Repeat.
Weave these two blocks alternately till there are six large blocks and five small ones.
Now treadle #, blue; 1, natural. Tabby. About four shots of each.
The 1,blue; 3,natural. Tabby. Repeat.
Weave these two blocks alternately till there are four of the larger blocks and three of the small ones.
This is one complete repeat of the pattern. To complete the bottom border, repeat the first group of blocks.

Before beginning the side borders color threads 235, 236, 886 and 887, to mark the edges of the borders. Four shuttles will be required for the weaving -- a tabby shuttle, a pattern shuttle in "natural" and two pattern shuttles in blue.

Treadle the pattern exactly as before, beginning with the second group of blocks. Weave the tabby shots and the shots in natural all the way across and the opposite shots in blue across the borders only. After the half repeat with which the side borders began weave in this way seven complete repeats of the pattern. Finish by weaving a top border to match the bottom border.

Treadling as written as for one standard 6-treadle fix-up

The effect of weaving in this manner is a center in pattern weaving in natural colored weft with a tabby, as in ordinary overshot weaving, surrounded by a border on opposites in two colors with the tabby entirely covered. My piece woven as described, went to an eastern exhibition, was much admired, and sold for a good price. The sketch at (b) of the diagram, and the detail sketch, give some idea of the pattern and plan of the piece.

At (e) of the diagram is given a detail sketch of the figure in pick-up weaving, on the Monk's Belt threading, used on the runner sketched at (f). Warp 578 threads. At 30 threads to the inch this will give a width a little over 19" in the reed. Thread the Monk's Belt draft as given at (c), putting in thirteen complete repeats, and then repeat the first six threads of the draft. The manner in which the figure is developed on the thirteen roses of the pattern is clearly indicated in the sketch. The roses may be of different colors or shades of color if desired. The same pattern could be woven in heavy materials for portieres or a couch cover, or could be used for curtain material instead of the arrangement sketched at (a). Work of this sort is often done wrong side up in the loom, for convenience in working, but many weavers prefer to weave right side up in order to see the effect they are producing, even though it is a little more difficult to do so.

At (g) is sketched a pick-up arrangement on the Monk's Belt threading used for a bag. This is simple but effective -- and quite easy to do. The sketch shows the design developed on eleven repeats of the pattern, but the number may be any uneven number, to suit the size of the proposed bag and the materials used. Begin by weaving a plain part for the top of the bag. Then pick up and weave the two roses on either side of the middle repeat. Weave a few more shots of plain tabby. Then begin the main figure by weaving the middle figure of the pattern, including the framing lines. Next weave the three middle figures, and at the same time weave the two detached roses, one on either side. Next weave the five middle figures, and so on down to the full width of the material. Weave two or three repeats of the pattern all the way across the fabric, for the bottom of the bag, and then drop one figure on either side in the following repeat, diminishing in this way back to the single middle figure. End as you began. The bag I once made in ~~xx~~ this manner was very successful.

At (h) is sketched a bag in pick-up weaving developed on the Sugarloaf threading, and at (i) is sketched the detail. Warp 532 threads. This is for one of the large bags at present so fashionable, the width, at 30 threads to the inch, being nearly 17 $\frac{3}{4}$ ". For a smaller bag warp 464 threads and put in one less repeat of the figure. In either case use the shortened draft, as indicated on the diagram, omitting a pair of threads from each of the larger blocks. The shortened pattern has a repeat of 68 threads. The manner of producing the figure is clearly enough indicated on the diagram. For the solid part that makes the bottom of the bag weave alternates shots of pattern weft on treadles 1 and 3 alternately for the space desired.

Other arrangements of these patterns will readily suggest themselves. The fun in this type of weaving is in pro-

Sept. 1930 - 5 -

ducing novel and original effects. These notes are intended merely to serve as suggestions, and to explain the method.

- - - -

The bargain silks supplied us proved to be very good, and mean a great saving in the cost of Christmas weaving. I have sent for a third lot and shall be able to fill a few more orders. The matter of postage has been very troublesome on these silk orders as some people have sent too much and most people have sent too little. On these packages, that with the wrapping weigh over six pounds express shipment is no more expensive than parcels post, so on future orders please send the price of the silks only and I will ship by express, collect. This will greatly simplify matters for me. In ordering please give me some idea what colors you prefer, to help me in sorting the material.

We are offered some cotton materials at a bargain price and I have had shipped to me a twenty-five pound lot in order to see just what they are like. Some of the material is excellent mercerized threads in good colors, finer than the perle cotton warps we have been using and very attractive. Some of the material is poorly dyed with colors that fade -- I exposed them for a week to the Montana sun, which is very potent -- and some of the material is too fine to be useful unless doubled and made into a strand cotton. It is not nearly as good a bargain as the silks. However, if I can make arrangements to have it shipped out from New York in 25lb lots at, say, \$6.00, there will be a very material saving in it. Please let me know if this appeals to you.

- - - -

Since writing the August Bulletin I have received the little shuttle-shelf designed by Captain Rix, mentioned in that issue. I have been using it on my Structo loom and find it a convenience. The same shelf fits the little "parlor" loom, though it has to be made wider to allow for the wider weaving space.

- - - -

Several Guild members have written to suggest that we get out a pamphlet of crackle weave patterns, and we shall be glad to do so if enough members are interested in the idea to pay the costs. The collection would include some of the patterns that have appeared in the Bulletin from time to time and also a number of new ones, specially prepared for the pamphlet. It would cost about a hundred and fifty dollars to get this out. If a hundred members want it enough to pay a dollar and a half for it I will undertake it. If a hundred and fifty want it it will cost only a dollar. My idea is to have twelve pages of diagrams, each with three or four patterns, and accompanying notes on treadeling, special arrangements, etc. The enclosed coupon will tell the story..

May 11 1930

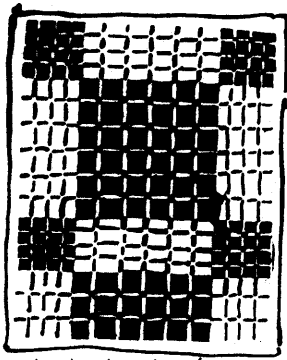

Detail of (b)

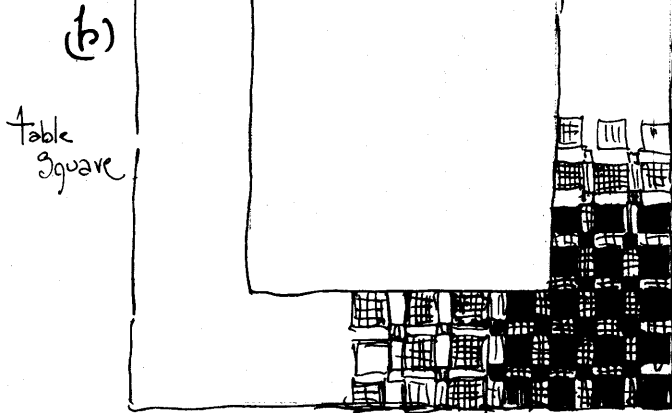
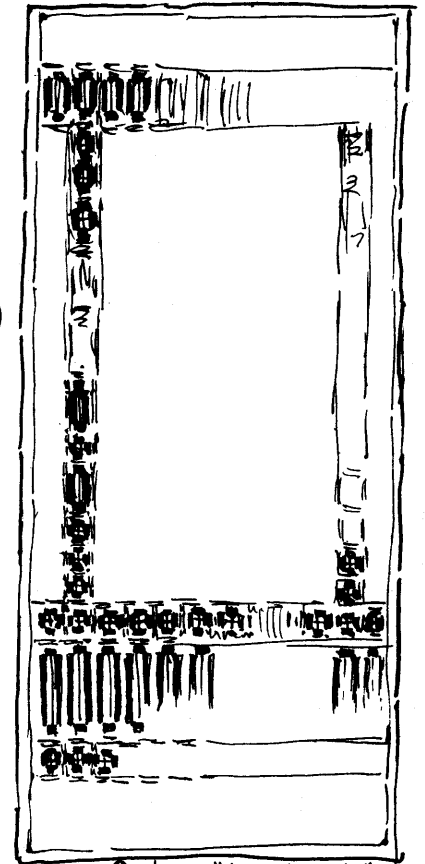
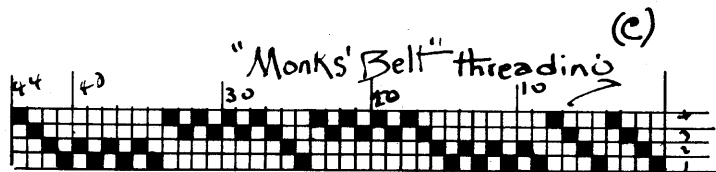

Table Square



(a)

Curtain "Monk's Belt"



"Monk's Belt" threading

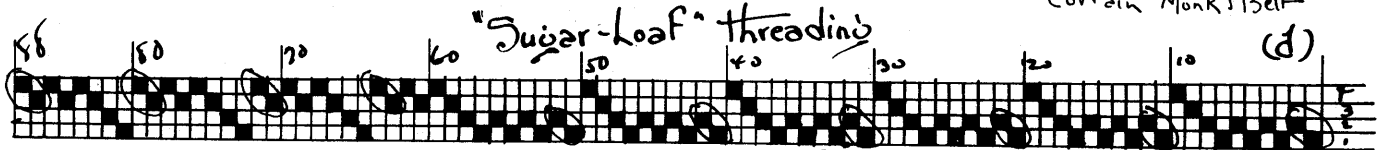

"Sugar-Loaf" threading

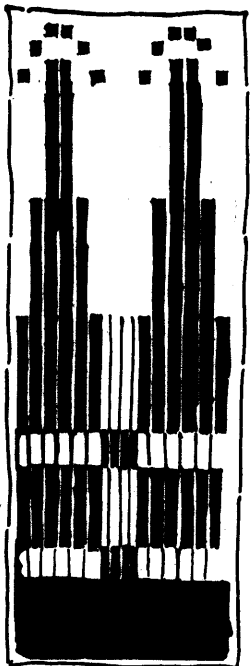

Detail of Bag

Basin. Mont. Aug. 1930

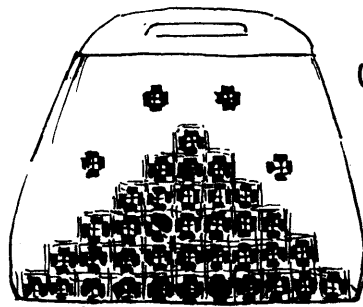

(g)

Bag "Monk's Belt"

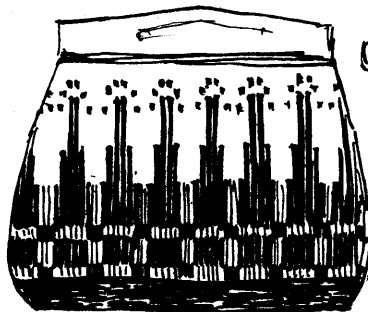

(h)

Bag "Sugar-Loaf"

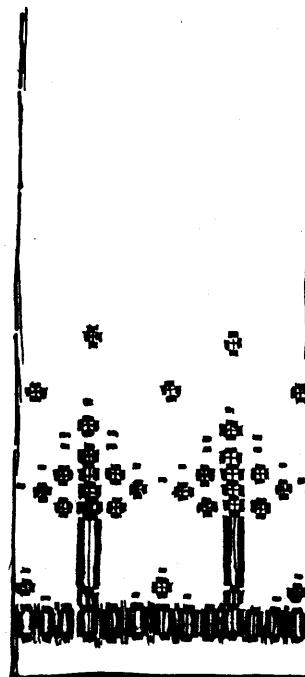

(e)

Runner, "Monk's Belt"

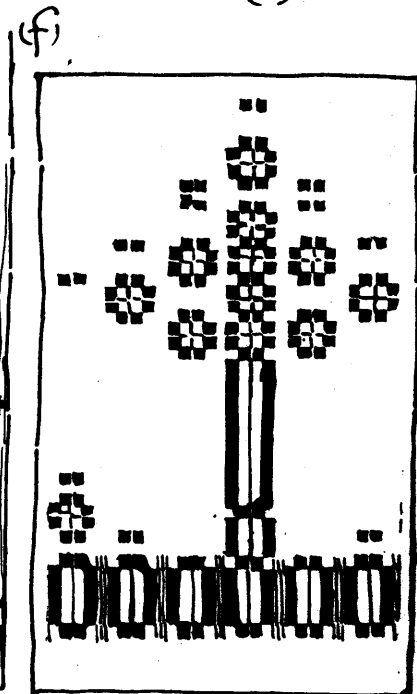

(f)

Detail of Runner
M. Matwaker

SHUTTLE-CRAFT BULLETIN
for
October, 1930

Annual Christmas weaving number.

The weaving done in preparation for Christmas is a little different from the weaving done at other seasons. Gifts to carry our Christmas greetings to friends, and things made to offer for sale at Christmas time must, above all else, be gay and charming. Of course we want them to be useful and durable, too, but not too desperately useful or depressingly durable. They should be designed to add to the joy of life -- that is the main thing.

They should have color, for color is one of the major joys of life, and they should have charm of texture, and bright, crisp little patterns, -- at least so I see it, -- and the things we want to make are the small "articles of luxury" rather than the big, serious, necessary things.

Bags are still very important. Every woman must have many bags -- bags for shopping in the morning, bags for afternoon, bags for evening, big, squashy bags to carry a bit of needle-work about in. We can hardly go wrong if we make many bags this Christmas. And let's make them gay! As gay as possible, in all the bright colors!

Towels -- little ones with bright borders -- make charming Christmas gifts. So do luncheon sets of square cloth and doilies. (Runners for the moment are less popular)

A delightful thing to make is a book for photographs, covered in hand-woven fabric. A simple form of binding described in a bulletin of some years ago and more recently in the Handicrafter, meets the purpose very well. The black paper sheets for filler can be bought at any stationery shop. Portfolios may also be made in a similar way and make unusual and charming gifts.

I have had a special request for a new pattern for small rugs. These make charming Christmas gifts -- to lie on the floor before a dresser or in front of a door on on a hearth. Woven in chenille they are lovely bath-mats, and with towels in the same colors and pattern make a charming "set."

The patterns in this number of the Bulletin have been specially designed to meet these particular needs, and will, I hope, make Christmas weaving for our members particularly delightful this year. I am pleased with them. Frankly, I think they are lovely and unusual.

Pattern (a) is a little figure in Crackle weave, intended particularly for towels and bags. It can be woven in many different ways and is charming in two colors. The illustration shows a few of the possible variations in treadelings, and though Guild members can, of course, follow them from this illustration I am giving the various treadelings as a time-saver at this

busy season. Other variations will, of course occur to anyone, as the weaving progresses.

Border No. 1, (in Crackle-Weave II. As-drawn-in)

Alternate treadles 1 and 2, -- 4 shots
 " 4 and 3, -- 9 shots
 " 2 and 1, -- 4 "
 " 4 and 1, -- 4 "
 " 3 and 2, -- 9 "
 " 4 and 1, -- 4 "

Repeat

Border 2, Basket-weave effect
 treadle 1, 6 shots
 " 3, 10 "

Repeat

Border 3, Crackle-weave I
 treadle 2, 3 times

" 4, 3 "
 " 2, 8 "
 " 4, 3 "
 " 2, 3 "
 " 4, 8 "

Repeat

Border 4 In Crackle-Weave I

treadle 4, 3 times
 " 1, 3 "
 " 2, 3 "
 " 3, 9 "
 " 2, 3 "
 " 1, 3 "
 " 4, 3 "
 " 3, 9 "

This figure is similar to No. 1 but the effect is very different.

Border No. 5 Crackle-Weave I

treadle 4, 3 times
 " 1, 4 "
 " 4, 8 "
 " 1, 4 "
 " 4, 3 "
 " 2, 3 "
 " 1, 4 "
 " 2, 8 "
 " 1, 4 "
 " 2, 3 "

Repeat

Border No. 6 This effect is woven with three harnesses sunk and one raised on each shed. It gives a long overshoot and most of the pattern weft on the face of the fabric. Not suitable for linen.

treadles 1 and 2 together 4 times

" 1 and 4, 4 "
 " 3 and 4, 10 "
 " 1 and 4, 4 "
 " 1 and 2, 4 "
 " 2 and 3, 10 "

Repeat

Border 7

treadle 1, 6 times
 " 3, 3 "
 " 2, 9 "
 " 3, 3 "
 " 1, 6 "
 " 3, 3 "
 " 4, 9 "
 " 3, 3 "

Repeat.

Draft (b) is an amusing little pattern with a great deal of "style" and character. It can be used for towels and bags with good effect, but was designed especially for fabrics for book-covers. It should, for this purpose, be woven in very fine materials, closely beaten. A fine mercerized warp or a fine linen or fine silk warp are suggested, with weft in silks or linens. A gold thread may be introduced into the tabby. The pattern is good also for flat purses and could be used for tobacco-pouches with a "zipper" closing. By the use of several colors very gorgeous effects are possible. The odd little one-sided effect of the figure is inherent in the weave and to my mind adds to the effect. However the pattern may be made perfectly symmetrical by threading the last thread of the draft on harness 2 instead of on 4 as shown. The two figures will not be exactly alike -- one will bow in and one bow out -- but each will be symmetrical.

Draft (e) is the same pattern as draft (b) but written larger and giving a bolder effect. For bags and towels this would be the better draft to use. The treadelings as given for (b) can be used for (e), with the number of shots increased in proportion. The draft may be written as large as one chooses by writing four more threads under each of the blocks of which the pattern is composed.

As the two figures of which this pattern is composed are exactly alike and exactly opposite, the two sides of the fabric are exactly alike, no matter what one does, unless of course, one weaves with three harnesses against one as at (a) 6.

Pattern (b) 1 -- an effect
in Crackle-Weave II
treadles 1 and 2 alternately

		8 shots	
"	3 and 2,	9	"
"	2 and 1,	8	"
"	3 and 4,	8	"
"	1 and 4,	9	"
"	4 and 3,	8	"

Pattern (b) 5
treadle 1, 4 times
" 2, 4 "
" 3, 4 "
" 4, 4 "

Repeat.

(This is very interesting
when woven in many colors.)

Pattern (b) 2 Crackle-I

treadle	1,	4	times
"	2,	4	"
"	1,	4	"
"	3,	4	"
"	4,	4	"
"	3,	4	"

Repeat

Pattern (b) 3 Crosses

treadle	1,	4	times
"	4,	4	"
"	1,	4	"
"	3,	4	"
"	2,	4	"
"	3,	4	"

Repeat

Pattern (b) 4

treadle	4,	4	times
"	3,	4	"
"	4,	4	"
"	2,	4	"
"	1,	4	"
"	2,	4	"

Repeat

Pattern (b) 6, border

treadle	4,	8	times
"	2,	8	"
"	1,	4	"
"	3,	4	"
"	1,	4	"
"	4,	4	"
"	1,	4	"
"	3,	4	"
"	1,	4	"
"	2,	8	"
"	4,	8	"

(This is nice for towels)

Threading (b) is a good one to select for the matched sets -- of bag, little tie scarf and beret -- that are so fashionable. For this use the warp should be in wool -- fabri is suggested -- or in silk, and the weft in wool. Nothing could be "smarter," and what a lovely gift for a very special friend! An all-over treadeling should be used for this purpose. No. 1, above gives a very dainty effect, while 2 and 4 are quite bold. No. 5 would, perhaps, be best.

Draft (c) was designed for a luncheon set. The complete draft when treadled as indicated below produces a square table mat, -- either with figures in the corner and the center and a plain border or with a plain center and a figured border. If made on a fine linen warp set at 36 to the inch these mats will be about 8" square. For smaller doilies in a similar effect use draft (d) which makes a five-inch square at 36 to the inch. For larger squares thread as follows: Draft (c), the first 176 threads. Then beginning with thread 85 of the draft to the end -- 211 threads. A total of 387 threads. The mats illustrated were woven on this threading. A pretty table set is four of these large squares, set close together in the center, and smaller squares as may be required.

For a large lunch-cloth in Pattern (c) thread as follows:	
From the beginning to thread 268	268 threads
Then begin at thread 85 and thread to 176, and repeat this 6 times	552 "
After the last repeat continue to thread 184	8 "
Then one complete repeat of the draft	295 "
Selvage on each side	8 "
	<u>1131</u>

At 36 to the inch this will give a width of about $31\frac{1}{2}$ " in the reed. To make it wider put in one more repeat of the 92-thread repeat of the central figure.

This may be treadled either of the two ways shown below. It seems unnecessary to write out the complete treadling. If desired, the center may be left in plain tabby and the side borders woven with separate shuttles as explained in the September Bulletin.

For a square the full width of the Structo loom, thread:	
3,4,1,2,3,4,1,4,3,4	10 threads
Then draft (c) to thread 176	176 "
Then from 85 to 176 (92 threads) repeat twice	184 "
Then from thread 85 to the end	211 "
1,4,3,4,1,2,3,4,1	9 "
	<u>590</u>

For the small squares on the Structo loom thread two complete repeats of draft (c) and weave two squares at once, using four shuttles and dividing the warp in the center.

These patterns are intended for weaving in the manner we know as Crackle-Weave II.

	Treadle Pattern (c) 1, -- as-drawn-in.	
treadles	1 and 2 alternately,	4 shots
"	4 and 3	" 4 "
"	1 and 2,	4 shots
"	4 and 3,	4 "
"	4 and 1,	8 "
"	3 and 2,	8 "
"	4 and 1,	4 "
"	3 and 2,	8 "
"	4 and 1,	8 "
"	4 and 3,	4 "

Treadeling, (c) 1 continued

treadles 1 and 2, 4 shots
 " 4 and 3, 4 "
 " * 1 and 2, 4 "
 " 4 and 3, 4 "
 1 and 2, 8 "
 4 and 3, 8 "
 1 and 2, 4 "
 4 and 3, 8 "
 1 and 2, 8 "
 4 and 3, 4 shots

Repeat from the beginning to (*)

Treadeling, Pattern (c) 2, -- Wreath-fashion

treadles 2 and 3, 4 shots
 " 1 and 4, 4 "
 " 2 and 3, 4 "
 " 1 and 4, 4 "
 " 3 and 4, 8 "
 " 2 and 1, 8 "
 " 3 and 4, 4 "
 " 2 and 1, 8 "
 " 3 and 4, 8 "
 " 1 and 4, 4 "
 " 2 and 3, 4 "
 " 1 and 4, 4 "
 " * 2 and 3, 4 "
 " 1 and 4, 4 "
 " 2 and 3, 8 "
 " 1 and 4, 8 "
 " 2 and 3, 4 "
 " 1 and 4, 8 "
 " 2 and 3, 8 "
 " 1 and 4, 4 "

Repeat to (*)

Draft (d) --as-drawn-in

treadles 1 and 2, 4 shots
 " 4 and 3, 4 "
 " 4 and 1, 8 "
 " 3 and 2, 8 "
 " 4 and 1, 8 "
 " 4 and 3, 4 "
 " * 1 and 2, 4 "
 " 4 and 3, 4 "
 " 1 and 2, 8 "
 " 4 and 3, 8 "
 " 1 and 2, 8 "
 " 4 and 3, 4 "

Repeat to (*)

Draft (d), Wreath-fashion

treadles 2 and 3, 4x 4 shots
 " 1 and 4, 4 shots
 " 3 and 4, 8 "
 " 2 and 1, 8 "
 " 3 and 4, 8 "
 " 1 and 4, 4 "
 " * 2 and 3, 4 "
 " 1 and 4, 4 "
 " 2 and 3, 8 "
 " 1 and 4, 8 "
 " 2 and 3, 8 "
 " 1 and 4, 4 "

Repeat to *

For a small rug, as illustrated, thread the first 84 threads of draft (c), and repeat four times 336 threads after the last repeat continue to thread 110 of the draft 26 threads

With a selvage of four threads on each side this makes a warp of 370 threads -- a width of 31 inches in the reed if set at twelve to the inch. At fifteen to the inch it would be only $22\frac{1}{2}$ " wide -- hardly wide enough, and another repeat of the figure should be put in, making a warp of 454 threads and a width in the reed of 30". In the crackle weave, however, a warp set at 12 to the inch makes a firm rug.

Treadeling:

treadles 1 and 2, 4 shots
 " 4 and 3, 4 "
 " 1 and 2, 4 "
 " 4 and 3, 4 "
 " 2 and 3, 10 "
 " 1 and 4, 10 "
 " 2 and 3, 4 "
 " 1 and 4, 10 "
 " 2 and 3, 10 "

This ends the border

Weave the body of the rug:

treadles 1 and 2, 10 shots
 " 4 and 3, 10 "

Repeat as required for length

Rug No. 2, -- not illustrated

Thread as directed for large mat on pattern (c), and treadle as directed, weaving the body of the rug with four repeats of the center figure instead of with two.

Rug No. 3. Thread draft (e) as follows:

Selvage	4 threads
six repeats of the draft	384 "
selvage	4 "
	<hr/>
	392

Or, selvage	4 threads
five repeats of the draft	320 "
first 34 threads	34
1,2, selvage	2 "
	<hr/>
	370

Here is a suggestion for treadeling: Weave in two colors -- say 2014 and 2111 in chenille, with a white tabby.

treadle 4, 8 times, darker shade
 " 2, 6 " lighter "
 " 1, 4, " " "
 " 3, 24 " darker "
 " 1, 4 " lighter "
 " 2, 6 " " "
 " 4, 8 " darker "

End of border

Weave about two inches in plain white tabby

Treadle the body of the rug:

treadle 1, 4 times, lighter shade	treadle 3, 4 times, dark
" 3, 4 " darker "	" 1, 4 " light
" 4, 4 " " "	" 2, 4 " light

(continue)

The border might be omitted and the entire rug woven in the repeat given for the body of the rug.

Treadeling (b)2 would also make an interesting rug on this threading, and is suggested for weaving in wool in a number of different colors.

- - - - -

Towels:

The nicest warp, in my opinion, for small towels is #20 singles warp-linen set at 36 to the inch. For weft the "special" linens in white and colors may be used and also the heavier linen "weaver" in white and colors. Drafts (A), (b) and (e) are all particularly good for weaving towels, and the threading of draft (c) suggested for rug No. 1 would also be charming.

Towels are sometimes woven with a colored hem and white for the body of the towel, and also are often made the other way: white for the hem and color for the body of the towel. An attractive way is to weave a hem in plain white, then a border of pattern weaving in heavy white with a colored tabby, and then a colored tabby for the body of the towel. Or a plain white hem, pattern weaving in color with a white tabby and a colored tabby for the body of the towel. Another interesting arrangement is a hem in tabby in color and the body of the towel in pattern, all in white -- say treadeling 2 for draft (a) which produces an interesting basket weave.

For larger towels heavy linen floss is very beautiful, used both as warp and weft. With this material I would suggest using draft (b). Any of the treadelings as given would be effective in this material. These heavy towels are quickly made and are very lovely indeed. To my mind they are the nicest towels we make. They should be quite large -- at least 18" wide -- and about a yard long. The plain tabby in this material is very handsome, either in white or in colors, and the borders should not be too elaborate.

Do not forget that linen pieces do not show their true beauty till washed and ironed. It is well to soak a new piece of linen several hours and to rub it severely in soap-suds and warm water, iron while still damp, and go over and over the piece many times.

- - - - -

Bags:

What shall one say of bags! This year they come in all sizes and several different shapes. Very large bags with wooden tops are particularly smart, and should be as gay in color as possible. All bags should be mounted. For tailored bags it is often a good plan to have a leather mounting, and to get a worker in leather to do the work, which must be expertly done. Drafts (a), (b) and (e) can be woven in thousands of ways for bags of all sizes and shapes. I have been making some out of fine artificial silks, that came in the bargain lot, combined with fine linen, and they are lovely.

Here is the "recipe" for a bag I made on the Structo loom: The threading was draft (a) and the weft was a heavy silk in a dull, brownish rose with a fine white silk for tabby. The warp was the regular Egyptian warp supplied for the Structo. First I wove: two tabby shots in white, one tabby shot in the heavy material and repeat till I had seven heavy shots. Then I put in one repeat and a half of treadeling (a)1 as given. Then I wove another section like the first, two white tabby shots and one heavy shot in color, till I had fifteen heavy shots. Then I repeated the section in pattern, and finished as I began. This piece was folded lengthwise of the material when the bag was made up.

Another bag: treadle 3, 10 times
 " 1, 6 "
 Repeat twice
 treadle 3, 10 times
 " This is the first border
 treadle 1, 4 times
 " 4, 8 "
 " 1, 4 "
 " 4, 2 "
 " 1, 2 "
 " 4, 2 "
 " 1, 2 "
 " 4, 2 "
 " 1, 4 "
 " 4, 8 "
 Repeat five times
 This is the second border
 Repeat first border
 Repeat second border
 Repeat first border.

This is also for a bag to be made up with a lengthwise fold. For a larger bag another repeat of each border may be used.

- - - - -

Note that the treadelings given are, as usual, for our standard six-treadle tie-up, and for any other method of tie-up must be transposed to correspond. For use on the Structo loom transpose as follows: For "treadle 1" read levers 3 and 4

"	"treadle 2"	"	"	1 and 4
"	"treadle 3"	"	"	1 and 2
"	"treadle 4"	"	"	2 and 3

In weaving pattern (a) 6 one leaver only should be drawn down for each shed when woven on the Structor loom.

- - - - -

A few announcements: Enough members have expressed their interest in the special Crackle-Weave pamphlet to make that a certainty. I am preparing the drawings and expect to have the thing ready to send out some time about the first of November. Will all those who wish this material ~~to~~ send in \$1.50 by that date with 25¢ additional for each extra copy desired. I shall not have many extra copies printed, so send in the orders in time or the supply of the pamphlet may be exhausted.

Oct. 1930 - 9 -

For the information of new members who did not see the first announcement, let me explain that this is to be a pamphlet with about 30 drafts in our new weave -- some of them patterns that have already appeared in the Bulletin but that are out of print and a number of new drafts. The \$1.50 is to cover the initial expense of printing, and those who agreed to subscribe this amount are entitled to buy additional copies, -- as long as the supply lasts -- at 25¢ a copy.

- - - - -

The bargain in artificial silks is still open. We have so far used about five hundred pounds of this material and the manufacturers inform me that we can procure about as much more if we order promptly. These silks are a "job lot" and come in many different weights and colors. A large part of the material is in black and white -- always useful. Instead of the regular price of \$3.50 a pound for material of this type we are getting it at 55¢ a pound in lots of five pounds or more. Some of the material is soiled and there are some cut skeins, but it is all useable, and is an amazing bargain.

Next month I shall have a bargain to offer in wool warp and one in cottons.

- - - - -

There seems still to be misunderstanding on some points. I have given up handling the regular lines of weaving materials since the closing of the Cambridge office, on account of the difficulties and delays due to being so far from the factories. Most of the yarns we used to supply from Cambridge can be had of the Emil Bernet and Sons Co., Jamaica Plain, Massachusetts.

I do, however, still supply looms and other weaving equipment, and shall be glad to have such orders go through me. Equipment is shipped from the factory.

We have a lovely new "swift" -- a tall, easy running one, made by Mr. MacKay who builds our splendid MacKay loom. The price of the swift is \$6.00.

I want to say a word about the many charming and appreciative letters that have come to me with Guild renewals for the coming year. It gives me great pleasure to know that the effort I put into this little leaflet of ours is appreciated, and that my work helps to make weaving interesting and profitable to our circle. A great many members write that they have complete files for the whole six years of the Bulletin's existence, many have bound their years and have supplied them with card indexes for easy reference. Perhaps I should repeat here that all who are full Guild members are entitled -- with their subscription to the Bulletin -- to unlimited correspondence privileges, and those who have found it impossible to complete the work of the course in one year may send in their work for credit at any time as long as they retain their Guild membership.

Mary M. Atwater

THE SHUTTLE-CRAFT BULLETIN
for
November, 1930

As several Guild members have asked for a Bulletin about the three-harness weave, that is to be the subject for this month.

The three-harness weave appears to be of Scandinavian origin. As far as I can discover, it was unknown to early American weavers, and, in fact, is less known among us today than it deserves. For many special purposes it is the ideal weave. However, it has a very bold and individual character, not in the least "Colonial," and it would be a mistake to weave draperies for a "period" early American room in this weave. It is suitable for use in rooms furnished in a modern -- though not "modernistic" -- manner, and is also perfectly suitable with furnishings of the Spanish influence.

Three-harness weaving depends almost entirely on color for its effects. There is also an interesting effect in texture, the heavy patterns, woven "on opposites" standing out in bold relief on the tabby background. Three harness weaving is an exciting adventure, and should be undertaken in that spirit. The whole thing depends on boldness, and if done timidly and without a touch of inspiration, may be incredibly stupid and flat.

It is impossible to work out one's effects beforehand on paper, and the finest results are always obtained by improvising on the loom. The sketches on the diagram do not, therefore, mean a great deal unless looked at with the eye of imagination that can see in the hatching gorgeous combinations of color.

When planning a large piece in this weave, such as a pair of portieres or a couch-blanket, it is advisable to weave a good-sized sampler, from which a selection of effects may be made. Otherwise the thing is a little apt to run away with the weaver and end quite differently from the way it started. Do not, however, hesitate to try whatever occurs to you. If not pleasing when done, take it out and try something else. Taking out is always a prominent feature of three-harness weaving, -- because the thing is so unpredictable. I dare say it is this fact -- to its inspirational character -- that it owes much of its charm.

The three-harness weave is particularly good for portieres, window-drapery, couch blankets, pillow-tops and large bags. It might also be used with dashing effect for the scarf, bag and beret sets suggested in the October Bulletin. It is not a suitable weave for linen, and should not be used where a fine and dainty effect is desired.

Adjusting the loom. In putting the three-harness weave on the Structo loom, or on any other loom with the "jack" type of mounting, no special adjustments are required. The extra harness or harnesses may be taken out of the loom or left in place as preferred, but if left in the heddles must be taken off or pushed aside so that they will not chafe the warp. On a counter-balanced four-harness loom the extra harness may be taken out and the two back harnesses that remain should be hung to balance the front harness. It is, perhaps, simpler to allow the fourth harness to remain, and then tie it to two or more treadles to preserve the balance.

Threading and tie-up. Nothing could be simpler than the threadings for this weave. Three drafts are shown on the diagram. Threading (a) gives, of course, a smaller, finer, pattern than threading (b) and should be chosen for the smaller articles. Threading (b), however, gives the more interesting effects and is the one most used. Threading (c) gives a six-harness threading which corresponds to draft (a). The tie-up as given at (a) may be used in weaving either draft (a) or draft (b), in the manner noted on the ~~draft~~ diagram, and either draft may be woven on the tie-up as given at (b). This will be further explained under "weaving". The tie-up at (c) corresponds with the tie-up at (b).

Warp and setting The setting of the warp is a very important matter in this weave. It should be heavier than usual for our Colonial weaves, and set a good deal further apart, so that in the pattern stripes (that are woven on opposites) it will be entirely covered. A little experiment is sometimes required to get the right setting and the right weft for the weight of fabric desired. Here are a few of my own "rule of thumb" results: For rugs use ordinary carpet warp, set at 12 to the inch, and thread two threads through each heddle; or use perle cotton #3 set at 10 to the inch and thread double. (This is more expensive but makes the better rug.) Or use the very coarse carpet warp sometimes obtainable set at 6 or 8 to the inch. These settings may be woven in "craft" rug-yarn, or in "Mudijara." I made some extremely beautiful rugs in this weave using the heavy hand-spun rug yarn Bernat carried at one time and may still be able to supply. This last, over the perle cotton warp, makes a truly gorgeous rug, but rather too costly for sale at a profit.

For portieres, splashy effects in pillows, couch covers, etc., use perle cotton #5 set at 15 to the inch, or perle cotton #3 set at 12 to the inch, or even ordinary carpet-warp set 13 or 14 to the inch. For weft use a fairly heavy yarn. Bernat's "peasant" yarn serves admirably.

For curtains (side-drapery for windows, book-cases, etc) warp Egyptian cotton at 24 to the inch, or ordinary 20/2 cotton at 30 to the inch or perle cotton No. 10 at 22 to the inch, and thread double through the heddles. For weft use strand silk, Shetland or homespun yarn, artificial silk, strand cotton or the like. This same setting may also be used for bags, pillow-tops and similar articles.

For couch blankets, warp in perle cotton #5 at 12 to the inch and weave in Germantown or other soft, heavy yarn, or -- which is greatly to be preferred, -- warp in Fabri yarn at 24 to the inch and thread double. Weave in Germantown or in Shetland yarn. For the sets of bag, bebet and scarf, warp in Afghan yarn at 30 to the inch, threaded double, or in spun silk with the same setting, and use tapestry yarn for weft.

Weaving There are two methods of weaving, that give very different results. According to the first method tie-up (a) is used and the treadles are woven in 1,2,3, order all the way through. Treadle 4 is used only in weaving plain tabby for headings, etc. Treadles 1 and 4 make the tabby sheds. This method of weaving may be used for either draft. It produces a fabric that is closely woven on the face but very "loopy" on the wrong side, and should therefore not be used except for such things as bags and pillow-tops where the wrong side does not matter. Some treadelings in this fashion are given on the diagram. In the second method the pattern is woven on tie-up (b), the treadles being used in "opposite" pairs. Treadles 1 and 6 are opposites, and produce the tabby weave; treadles 2 and 5 are opposites, and treadles 3 and 4. When woven by this method the "wrong" side of the fabric will have a lively and interesting effect, though entirely different from the right side, and not always as handsome unless one is careful in arranging the weave so that both sides will be equally good.

The same two methods of weaving may be used for the six-harness version of the weave. The advantage of putting the weave on six harnesses is simply that one may, if one chooses, weave a fine tabby foundation, a finer warp being used and threaded singly as in ordinary overshot weaving. Treadles A and B weave this fine tabby. A double tabby may also be woven on this draft by tying another treadle: 1,2,5,6, and using this treadle with treadle 2. Otherwise the effect of the weave on six harnesses is the same as on three.

But the important thing in the end is color. Without color, and a great deal of it, the whole thing falls flat. My own method of procedure is to set up the loom with the chosen warp, get a quantity of the appropriate weft material in two neutral colors, one light and one dark, to serve as the foundation for the effect and then to have in addition a collection of every possible color, especially all the brightest shades obtainable, and also black and white. I wind a shuttle with every color I have, and sitting in the midst of all this excitement I proceed to a real orgy. There is really no weaving experience quite like it. What could be more delightful for a dark day in winter! And the thing when done -- whether curtain, pillow-top or what-not -- will give a bright, clear accent wherever it is put.

Another consideration that appeals to many of us: things done in this weave are, in my experience, particularly saleable. They have a fascination. People simply have to have them. There is no way of keeping even a sample unless one cuts it up into impossible small pieces.

To write out in detail the weaving of even a simple piece in this weave would require reams of paper, and would be more confusing than helpful. However, as a help in getting started I am giving below a few borders taken from a piece of weaving of my own. By weaving these as written one may get into the spirit of the thing.

Colors used: "camel", # 167 on Bernat's card of "Peasant" yarns, Main background color (c) in the directions as given below; black, (b); brown #169, (br); apricot, (a); jade, (j); yellow (y) peacock, (p); buff, (bf).

tabby, (c) as desired.

First border: treadle 2, (j); two tabby shots, (c); treadle 2, (j) two tabby shots (c); one tabby shot, (b); two tabby shots, (c) treadle 3, (j) two tabby shots (c); treadle 3, (j)

tabby (c) as desired.

Second border: treadle 4, (c); 3, (c); 4, (c); 3, (c); 4, (c); 5, (c); 2, (a); 5, (c); 2, (a); 5, (c); 2, (b); 5, (c); 2, (b); 5, (c); 2, (a); 5, (c); 2, (a); 5, (c); 4, (c); 3, (c); 4, (c); 3, (c); 4, (c)

tabby, six shots, (c)

third border: treadle 2, (bf); two tabby shots (c); 2, (bf); four tabby shots (c); treadle 3, (a); two tabby shots (c); 3, (a); four tabby shots (c); treadle 2, (br); two tabby shots (c); 2, (br); four tabby shots, (c). This is the center, repeat back to the beginning.

Six tabby shots (c)

Repeat second border

Six tabby shots (c)

Repeat first border

Wide space of tabby in (c)

Repeat first border, tabby six shots (c), Repeat second border tabby six shots (c)

Fourth border: treadle 4, (c); 3, (c); 4, (c); 3, (c); 4, (c); 5, (c); 2, (br); 5, (c); 2, (br); 5, (c); 4, (br); 3, (c); 4, (br); 3, (c); 4, (br); 5, (br); 2, (b); 5, (br); 4, (b); 3, (a); 4, (b); 3, (a); 4, (b); 5, (b); 2, (p); 5, (b); 2, (p); 5, (b); 4, (b); 3, (j); 4, (b); 3, (j); 4, (b); 3, (j); 4, (b); 3, (j); 4, (b); 3, (j); 4, (b); 3, (j); 4, (b); 3, (j); 4, (b); 3, (br); 4, (b); 3, (br); 4, (b); 3, (y); 4, (b); 3, (y); this is the center of the border, repeat backward to the beginning.

Six shots tabby (c); repeat second border; six shots tabby (c); repeat first border.

The borders woven as indicated are "on opposites" no tabby being used between pattern shots. The effect of weaving in this manner is to produce heavy borders that stand out from the fabric in considerable relief, and are most effective.

- - - - -

The copy for the crackle-weave pamphlet has been in the hands of the printer for some time, and the booklet will soon be ready for distribution. It contains 33 drafts, most of them illustrated, treadelings for all, and many special suggestions for use.

It may interest Guild members to know that the process used in reproducing the drawings for the booklet -- and also for the illustrations in the Bulletin -- is a new process not yet known in all parts of the country. Our printing is done in New York.

- - - - -

A new lot of artificial silks is due to arrive within a few days, so Guild members whose orders have been held up may expect to receive the material promptly now.

I have a new bargain for the Guild -- in wool warp, this time. The material is of several sizes, and most of it is white. It comes wound on spools and cops and some of it in skeins. I enclose samples. The price of this material is \$1.00 a pound in five-pound lots.

Wool wound on spools loses much of its elasticity, but this returns to a great extent when the finished fabric is washed and pressed. For those who use wool warp for dress and coat-fabrics, for scarves and baby blankets, will welcome the opportunity to buy spooled material.

I intend to send in an order for this material about the fifteenth of November, and will ask anyone wishing some of it to let me know before that date if possible. It is not necessary to send money with the order. I will make shipment c.o.d. if preferred. It takes about three weeks for the orders to come through, as they are shipped by freight from the east, so those ordering will not receive the material before the 8th or 9th of December. I enclose samples and will, as far as possible, fill orders with the numbers preferred. Those wishing skeined material rather than spooled, please so state.

- - - - -

NOTE: Treadelings given are as for the tie-up shown on the diagram. Structo weavers should transpose as follows: for "treadle 1" read, levers 2 and 3; for "2", read, levers 1 & 3; for "3", read levers 1 & 2; for "4" (tie-up b) read lever 3; for "5", read lever 2; for "6", (and for "4", tie-up a) read lever 1.

- - - - -

Shuttle-Craft Bulletin

November 1930

(b)

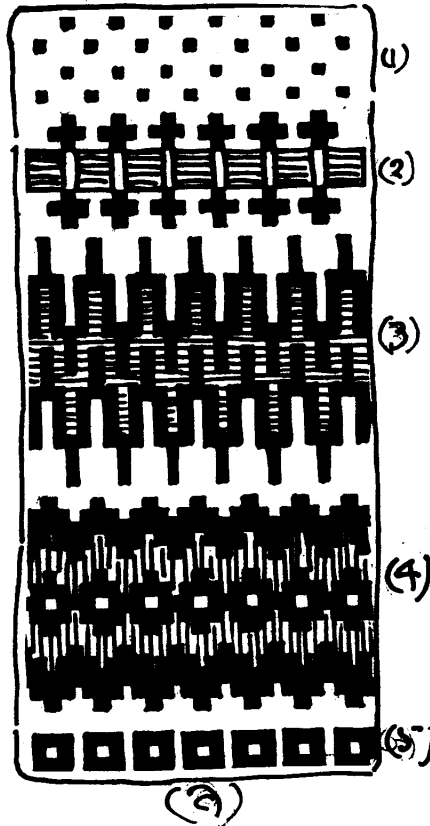
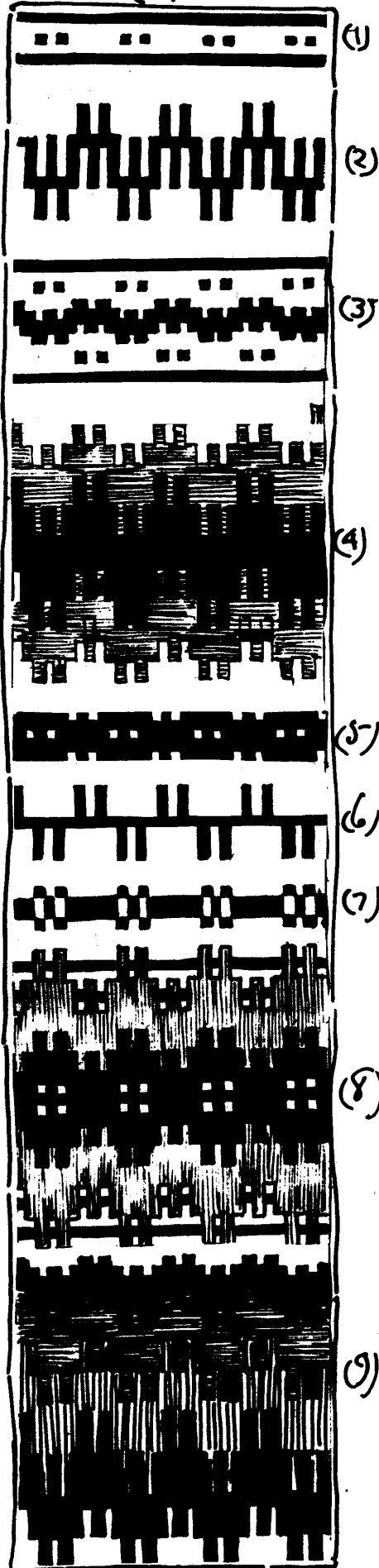

Threading Drafts

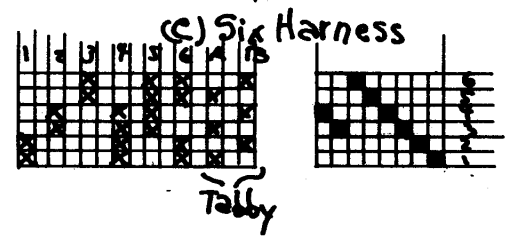
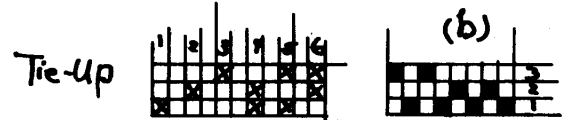
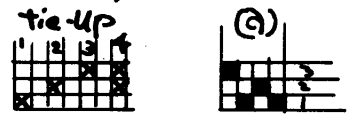

In weaving with the tie-up as given at (a) above the three first treadles are used in succession, without a tabby, as follows:

Dots
Treadle 1, treadle 2, in color (x) --back-ground color. Treadle 3, color (y). Repeat three or four times.

treadles 1,2,3, all in color (x) Repeat
1, (x); 2, (y); 3, (x). Repeat.

1,2,3, all in color (x) Repeat
Repeat from the Beginning

Border (a)2

Cross: 1 and 2, color X; 3 color (y). Repeat. 1, (y); 2, (x); 3, (y)
1, (y); 2, (x); 3, (y). Repeat
1, 2, (x); 3, (y). Repeat

Square: 1,2, color (z); 3, (x) . Repeat as required -- about 9 shots each
Repeat cross.

Border (a)3

1, (x); 2, (y); 3, (x). Repeat -- about 9 shots of each.
1,2 color ((y); 3 (x). Repeat -- about 3 shots each
1, (y); 2, (z); 3, (x). Repeat -- about 9 times
1, (y); 2, (z); 3, (y). Repeat about 3 times
1,2, (z); 3, (y). Repeat about 3 times
1, (z); 2, 3, (y). Repeat about 6 times
1, (z); 2, (y); 3, (z). Repeat about 3 times
1,2, (y); 3 (z). Repeat about 3 times
1, (y); 2, (x); 3, (z). Repeat about 9 times
1, (y); 2, (x); 3 (y). Repeat about 3 times
1,2, (x); 3, (y). Repeat about 9 times.

To weave on a Structo loom two levers must be used for each shed.
For "1", read: levers 2&3. For "2" read: levers 1&3. For "3", read: levers 1&2.

Pattern (a) may also be woven on the tie-up as given for pattern(b).
For instance treadle border (a)2 as follows:
Cross: treadle 4, color (x); treadle 3, color (y). Repeat about 3 times
5, (x); 2, (y). Repeat about 3 times
4, (x); 3 (y). Repeat about 3 times

Square: 4, (z); 5, (x). Repeat about 2 12 times
Repeat cross.

For the Structo loom read tie-up (b) as follows: For "1" read: levers 2&3. For "2", read: levers 1&3. For "3" read: levers 1&2. For "4" read: lever 3. For "5" read: lever 2. For "6" read: lever 1.

SHUTTLE-CRAFT BULLETIN
for
December, 1930

As announced some time ago, this issue of the Bulletin has been planned to answer some of the questions about weaving with linen that appear to be on the minds of many Guild members. The subject of linen weaving would fill volumes if treated at all completely, -- all I shall attempt here is to give some very practical suggestions, and I shall limit these to the making of linen towels.

These are the pressing questions: (1) The material itself -- what are the difficulties, if any, about using linen for warp? what warps and wefts are most satisfactory for towels? how much material is required for, say, six towels? (2) What weaves and patterns are most satisfactory for towels? (3) Is it best to use white, "natural" or colored threads? (4) How should hand-woven linens be finished?

(1) The Material. Many weavers hesitate to use linen as warp because of the real and fancied difficulties. Linen has no stretch, like cotton, wool and silk, and when fine "singles" linen is used for warp there is apt to be trouble with broken threads. This may be avoided to a great extent by keeping the warp damp. If the warp is on spools, for sectional warping allow the spools to lie rolled in damp cloths for twenty-four hours or so. A chained warp should have similar treatment, but leaving it overnight will be long enough. And keep the warp damp during the weaving also. My own practise is to keep a wet bath-towel rolled around the warp-beam when the loom is not in use and to dampen the stretched part of the warp with a sponge or soft cloth from time to time as may be required. The warp need not be dripping wet but it should be thoroughly moist. Moreover, never leave the warp at a tension when the loom is not in use, and do not release the tension with a sudden jerk. In beating, do not pound -- several light blows with the batten will be better than a single heavy blow. And take particular care not to narrow in while weaving.

It is, of course, necessary to use warp-linen for warp. The cheaper weft-linens, very attractive when one wishes to produce a rather rough and uneven texture, will not do at all as warp. Also, avoid a bleached linen that gives off an odor of chlorine. Chlorine is used in chemical bleaching and if the bleaching is not carefully done and the chemicals well washed out of the thread the fibres will be seriously weakened.

The linen threads we use are, practically all of them, imported from Europe. Flax is raised in the United States but is not spun into fine threads. The most beautiful colored linen threads to be had are the D.M.C. linens, but these are ruinously expensive, and come done up in small skeins as for embroidery which are inconvenient for weaving. However we sometimes use them in borders for towels. Nothing could be lovelier, and the dyeing is of the well-known D.M.C. quality. Other sources of

Other sources of supply are the Linen Thread Company with offices in many cities, the Hughes-Fawcett Co. of New York and the Bernat Company who supply so much of our weaving material. I have found the Hughes-Fawcett prices the lowest, but the material uneven in quality and sometimes very disappointing.

The cost of linen threads in this country is one of our difficulties. I have been trying for some time to find a linen bargain to offer the Guild but so far have been unsuccessful. One of our members is trying the experiment of importing linen from Sweden and will, I am sure, be willing to give the Guild the information about this when it is available

The relation of yardage to weight in linen is based on the length of a "cut" of linen -- 300 yards. A #1 linen would be one cut or 300 yards to the pound; a #14 linen is fourteen cuts or 4,200 yards to the pound; a 40/2 linen -- two #40 threads twisted together -- runs 6,000 yards to the pound and so on. In calculating quantities of spooled material, however, remember that the weights are "net" and include the weight of the spool or cop. There is no yardage in the spools, so one must figure an additional quantity to cover the shortage. Multiply the number of inches in width of the proposed fabric by the number of warp-ends to the inch, and multiply this by the number of yards in length of the proposed warp. This will give you the total yardage of your warp, and by dividing by the number of yards to the pound in the thread you intend to use you will have the weight of material required for the warp. If the weft is to be the same material as the warp -- as in so many linen weaves -- simply figure as much again for weft. If a different weft material is to be used this must be figured separately.

It is almost impossible to procure in this country the very fine linen warps quite generally used by European weavers. The finest warp-linens offered by most of the supply houses are #20 "singles" or "flat" linen and 40/2 round linen. These warps are excellent for towels, and probably most weavers will find them fine enough. They should be set about 36 or 38 ends to the inch. Whether to choose the round or the flat linen is a matter of taste. Round linen gives a smooth, even fabric while flat linen produces a rougher fabric with rather more character, due to the unevenness of the thread. For towels I myself prefer flat linen, though a warp of flat linen is a good deal more troublesome than a warp of round linen.

Large towels made of heavy linen floss, warped and woven at 15 to the inch, are very handsome indeed. And there are various combinations of fine and coarse linen that give excellent results, as will be noted later.

(2) Weaves and Patterns . The distinction between "weave" and "pattern" may not be clear to everyone; by weave we mean the structural plan of the fabric, and by pattern the figure or design. Most patterns may be woven in many different weaves. The special beauty of linen is chiefly in its texture, and this depends on weave rather than on pattern, so weave is of first importance in planning a project in linen weaving. The damask weave is, of course, particularly handsome in linen, as the satin struc-

ture of the fabric brings out the lustre of the material. Damask, however, requires a very elaborate loom and is out of the question for most American hand-weavers. Linen may be woven in the ordinary four-harness overshot weave, though this is the poorest weave for linen. A pattern should be selected in which there are no large blocks, for linen threads do not cling together like woolen threads and in long skips have a stringy appearance that is far from handsome. Special linen weaves are "Huck", "Ms and Os", what we know as the "Bronson" weave (called "spot" weaving or "diaper" in the old books, and the "twill", "Bird-Eye" and "Goose-Eye" threadings. To these may be added the "Summer and Winter" weave and our new "Crackle" weave. There are a number of lovely linen weaves made on eight harnesses but impossible on four harnesses, but there is not sufficient space in this Bulletin to mention them in detail.

The pattern to select is entirely a matter of taste. If the weave is well-chosen the pattern will prove satisfactory, no matter what it is. However for some things we like small figures and for other pieces, large and elaborate figures. Otherwise there is no choice.

(3) Color. Linen is extremely refractory to dyeing. In order to produce certain deep, strong colors on linen it is necessary to use a pound of dye-stuff to a pound of thread. This is the reason for the high price of colored linens. The ancient weavers were usually content to weave linen in its natural color and bleach it after weaving if a true white was wanted, contenting themselves with pattern effects produced by the weave. And it seems to me doubtful whether colored linens are in any way to be preferred to white or natural. The fashion of the day, however, is for color in everything and if one is weaving for profit rather than for one's own use and pleasure this must be considered. It is usually unwise to try dyeing linen oneself -- unless one happens to be a skilled dyer with the facilities for vat dyeing -- and in buying linen threads it is particularly important to make sure that colored linens have been vat-dyed. Linens should be able to stand unlimited washings; in fact the oftener a piece of linen is washed the softer, more lustrous and more beautiful it becomes till it falls apart from extreme old age. Ordinary dyeing will not endure. In planning a linen piece make the plan as for weaving in white, and add color if you must. Then if the colors fade they can be bleached out and the piece will still be handsome.

(4) Finishing Linen when taken from the loom is still far from being a finished product. Anyone who has never woven linen before will be disappointed by its appearance, which is harsh and wiry. The new fabric must be well washed in warm soap-suds, and rubbed severely. A soaking of many hours is desirable, too. After washing wring it out and allow it to hang and dry for a little while -- till it stops dripping. But begin ironing while it is still very damp, and go over and over it with the iron till it is dry. The amazing change that results from this simple treatment fully repays one for the work involved. And of course the oftener the piece is washed and ironed the handsomer it becomes.

Another thing that seems to puzzle some weavers is the

question of sizes. How big should towels be made? This is, of course, largely a matter of taste. In general, however, one may say that though large towels may be made of fine materials if one likes, very small towels should not be made of coarse materials. Proportion is important, too; a towel that is too long for its width looks like a short runner instead of a towel, while a towel made too short for the width looks like a badly shaped table-mat. It is dangerous to make hard and fast generalizations -- a very small towel should be longer in proportion than a large towel, and one with much decoration should usually be a little longer than one in the same width with a narrow border. The best I can do is to give a few "rule of thumb" sizes that seem to me agreeable.

Small "guest-towels" may be made 16" wide and 26" long, finished. These should be woven of fine materials, and should be set about 16 3/4" wide in the reed to allow for shrinkage. A good proportion for hem and border is: hem, 1", border 3 1/2" wide at the widest, and may be a little narrower if desired. Middle part in plain weaving, 17" finished. The towel should be woven 30" long to allow for turning up the hem and for shrinkage.

Large towels 20" wide are a very handsome and useful size and may be made either in fine materials or in coarse linen floss. They should be about 32" long, finished. Hem and border together may measure six inches deep, no wider. They may be narrower if desired, but should not be so narrow as to appear "skimpy."

A good way to plan a towel is to cut a paper pattern, trimming the paper to the size you wish and marking off on the paper the depth of hem and border. Be sure to fold the pattern as a towel is usually folded and hang it over a towel rack in order to judge of the proportions.

Following are a few "recipes" for towels that may be found useful.

For a set of six small towels in #20 singles linen -- the same material used both for warp and weft -- make the warp 7 1/2 yards long and of 600 ends. Set the warp at 36 to the inch making a width of 16 3/4" in the reed. Thread one of the small patterns in Bronson weave: 1,2,1,2,1,3,1,4,1,4,1,3 and repeat or :1,2,1,2,1,3,1,2,1,2,1,3,1,4,1,4,1,3,1,4,1,4,1,3. (These are patterns 256 and 257 in my book on weaving.) Make a tie-up to four treadles: treadle No. 1 tied to harnesses 1 and 2; treadle No. 2, to harnesses 1 and 4; treadle A to harness 1, alone; treadle B to harnesses 2,3 and 4. Weave 7" of plain tabby on treadles A and B, for a deep hem, that should be hem-stitched. Weave 21" in pattern weaving as follows:
 treadle 1, 3 shots -- tabby B between pattern shots
 treadles B,A, and B
 treadle 2, 3 shots -- tabby B between pattern shots
 treadles B,A,B
 Repeat.
 Weave 7" plain tabby.

The plain tabby hems may be woven in a color if desired, with the body of the towel in white, or the hems may be white and

the pattern shots in color.

The same plan may be used with the "huck" threading in its simplest form, -- though this gives a more ordinary effect.

(The treadeling given is for the smaller of the two patterns; the larger pattern is similar and is woven by treadeling each of the two blocks twice instead of once as written.)

For the Structo loom the treadeling should be transposed: for "treadle 1" read levers 3 and 4; for "treadle 2, read levers 2 and 3; for "A" read levers 2,3 and 4; for " B", read lever 1, alone.

For this set of towels $1\frac{1}{2}$ lbs of thread will be required -- $1\frac{3}{4}$ lbs, allowing for the spools. The cost of the material will therefore be about 63¢ per towel. One should be able to weave three or four of these little towels in a day's work. This is mentioned as a basis on which to figure a selling price. If made for sale, however, it would be more economical to warp for more than six towels and the wastage would be less, making the cost of materials somewhat less.

For 6 large towels in linen floss warp 315 threads and make the warp 8 yards long. Set the warp at 15 to the inch. Thread in "Bird-Eye"; 1,2,3,4,1,4,3,2 and repeat. Use the standard six-treadle tie-up used for overshot weaving. Weave $2\frac{1}{2}$ " plain tabby for a narrow hem, or weave $1\frac{1}{2}$ " plain tabby and finish with a rolled hem. Weave a border about $4\frac{1}{2}$ " deep in pattern weaving, without a tabby. Weave 23" plain tabby for the body of the towel and repeat border and hem. This is intended for weaving in white.

For a color effect warp in pale green, color 217 on Bernat's linen card. Weave the hem in the same color and material as the warp. Weave the border as follows:

treadle 4, one shot, color 218
 " 3, 2 shots, color 223
 " 4, one shot, color 218.

Weave a tabby in white linen "weaver" between pattern shots.

Weave 4 shots of tabby in color and material like the warp.

Weave a broad border as follows:

treadle 3, 3 shots, color 218
 " 4, 4 " " 217
 " 3, 3 " " 218
 " 2, 3 " " 223
 " 1, 4 " " 218
 " 2, 3 " " 223
 " 3, 3 " " 218
 " 4, 4 " " 217
 " 3, 3 " " 218

tabby in white
 linen "weaver."

Weave 4 shots of tabby in color 217

Repeat narrow border.

Weave the body of the towel in plain tabby in color 217 like the warp. Repeat borders and hem.

For six towels about $3\frac{1}{2}$ lbs of material will be required. To allow for the spools $3\frac{3}{4}$ would be a safer allowance. This makes each towel cost about \$1.35 for materials if "natural" color is used

and about \$2.00 each if done all in color.

Color No. 220 might be used for warp and plain weaving, with borders in color 239 set off with black, or the same warp with borders in color 210 and color 203.

Handsome towels in heavy materials may be made on the draft for a small rug given in the October Bulletin, and drafts (a) and (b) in the October Bulletin are good for small towels in fine materials.

- - - - -

Bargain offers in Materials for December.

The fine wool warp mentioned in the November Bulletin may still be had. I shall order again about the end of December .

There is still a small amount of the 55¢ artificial silk to be had.

I have a small lot of real silk in weft-weight in a gorgeous shade of henna, bought for my own use. I do not, however, need it all and the first few people who ask for it can have some of it. The price is \$3.00 a pound -- for material worth regularly about \$10.00 a pound. Orders must be for a pound or more.

I have two new bargains in artificial silks. I enclose samples of "heavy embroidery silks" supplied on paper spools of about 2 oz each. There is only 200 pounds of this and when it is gone there will be no more, so I suggest that those who wish some of it order as promptly as possible. The price is 75¢ a pound, in lots of four pounds or more. In ordering please say whether you wish a variety of colors or whether you wish a large quantity of the same color, -- also whether you prefer light colors or the darker shades. The samples show the size and grade of the material but not, of course, all the colors.

The other new bargain is also a small special lot. These are fine twisted silks on wooden spools. The material is strong enough to use for warp in fine scarves, or doubled for heavier fabrics. It can also be made into strand material for weft. But the most interesting part of the bargain lies in the spools. These are the special smooth spools with heads used for silk and cost 25¢ each when one wants to buy them. They are ideal for the spool-rack. Wound with silk as they are they weigh about six to the pound, so that in five pounds of this material one gets 30 spools at half price with the silk thrown in! The price of this lot is also 75¢ a pound, -- in lots of five pounds or more.

If cash is sent with the order I will ship by express, charges collect. Or if you prefer I will send the material c.o.d.

- - - - -

The "Crackle-Weave" pamphlet has been sent out to those who ordered it. I have a few copies left so I shall be able to supply late orders. The pamphlet contains 33 drafts of patterns in the new weave with notes and treadelings.

May McEwen

Patterns in Grackle-Weave for Christmas Weaving

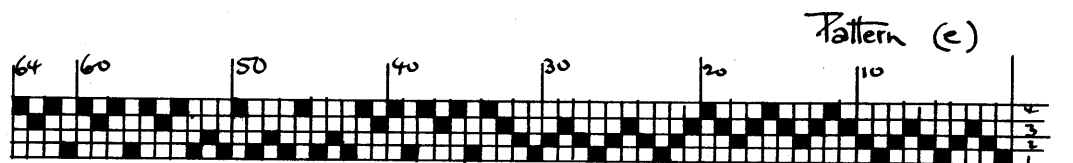
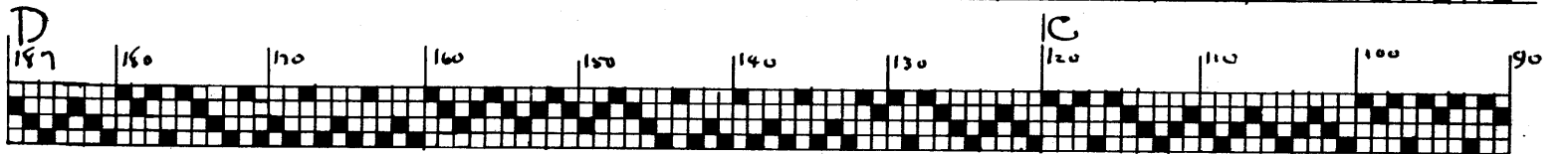
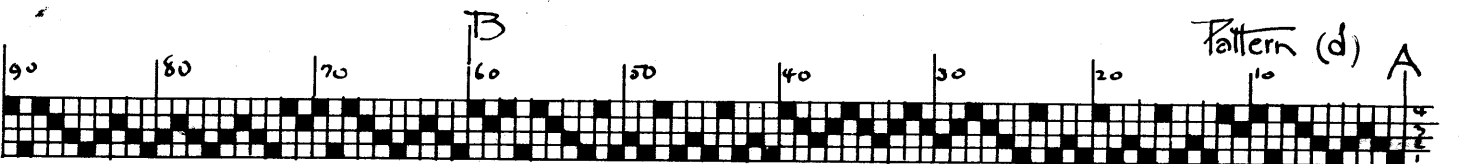
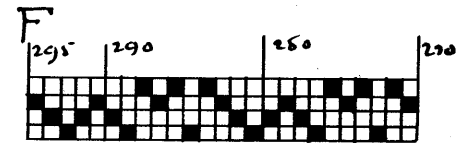
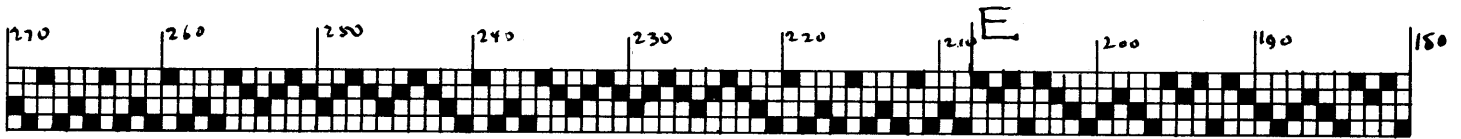
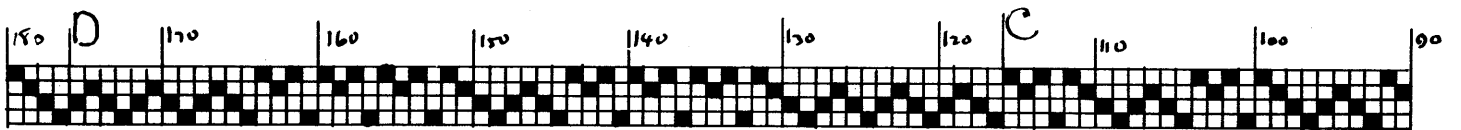
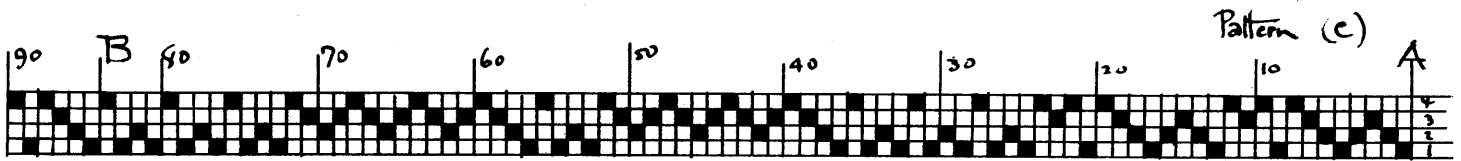
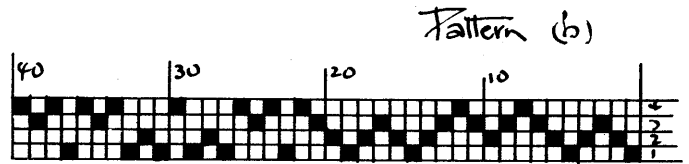
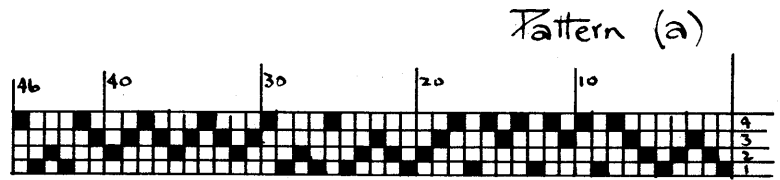
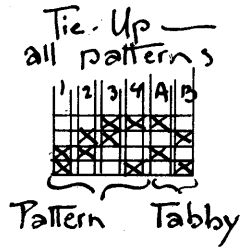

(this is the same pattern as at (b), but written larger)

Pattern (c)

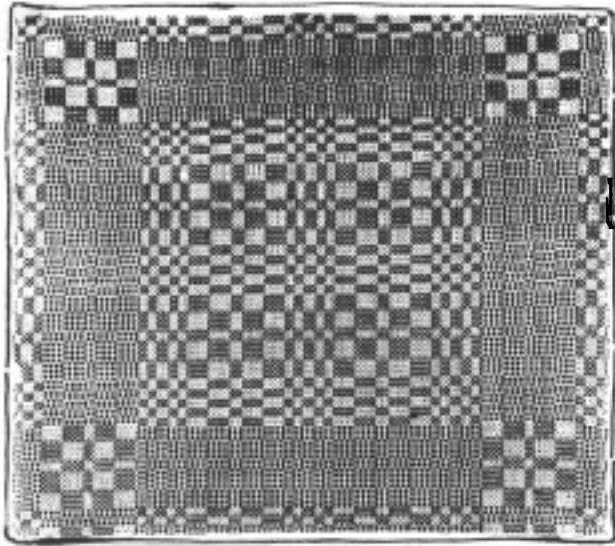

(1)

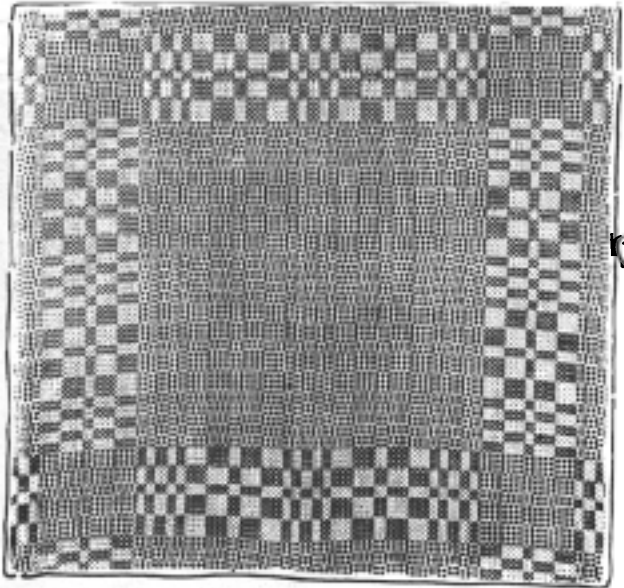

(2)

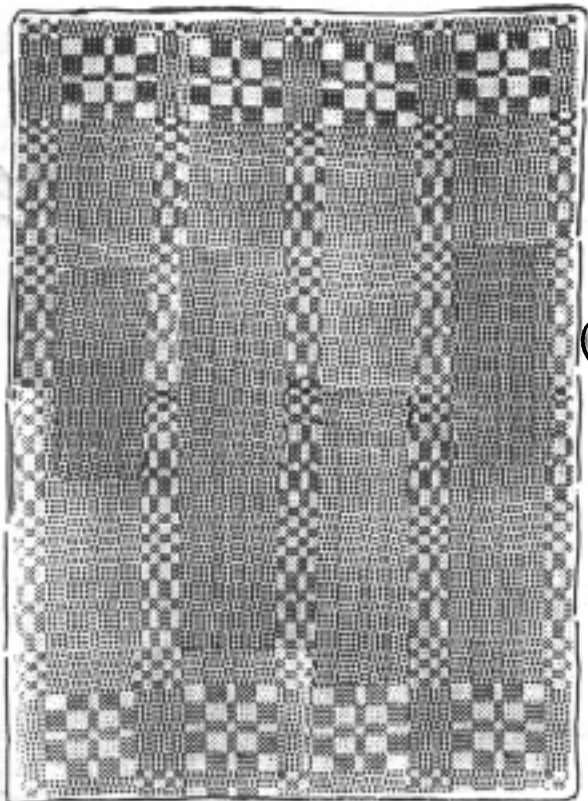

(3)

Pattern (a)

(1)

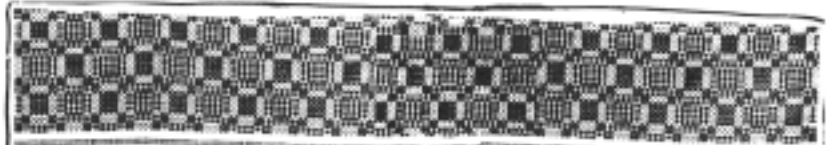

(2)



(3)



(4)

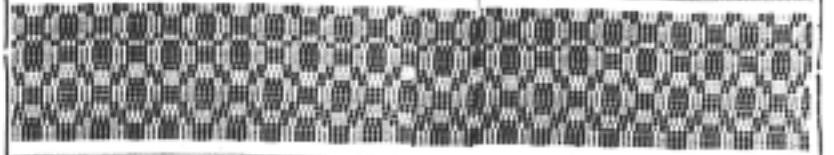

(5)



(6)



(7)

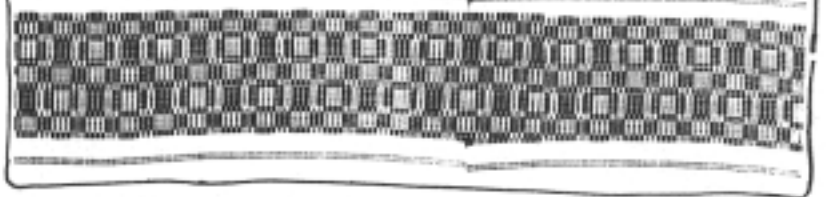

Pattern (b)

(1)

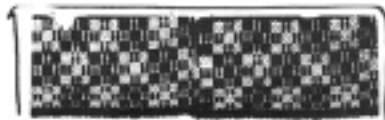

(2)



(3)



(4)



(5)



(6)



Patterns in Crackle Weave