

PRACTICAL WEAVING SUGGESTIONS

VOL. 1-60



WEAVING WITH WOOL

by Lela Gordon

When I first took up weaving about 15 years ago, I was thrilled with the endless variety of articles that could be woven from cotton, linen or wool, and the marvelous things the mills have accomplished with synthetics in the last few years have widened the possibilities even more. But I soon found out that, generally speaking, cotton and linen weaving requires a heavier beat than wool, and I had to use more muscle than I was willing to part with. Therefore, while I have not given up cotton and linen weaving altogether, most of my time and effort is devoted to weaving woolen articles and there are not enough weaving hours in the day to enable me to do all the lovely things that are possible with wool.

For the practical minded weaver who notes that the cost of wool threads is somewhat more than cotton or linen, let me suggest something that should pay the entire cost. If the project calls for a warp that will produce 3 articles — skirts, yardage, scarves, baby blankets or whatever, increase the warp enough for an additional article and sell it. There is almost always a ready market for good hand-woven woolen articles, and the sale of one should pay for all four.

At the outset, here are a few suggestions made for the benefit of the weaver just starting to work with wool:

Usually, (depending on the nature of the fabric you are making) wool takes a very light beat — each pick must just barely touch the last one. The beater should be brought toward you on an open shed until the weft pick just barely touches the last one, then holding it in place with the beater, change the shed. This serves two purposes. It holds the web evenly spaced and also clears the shed for the next pick. This helps to reduce loom shrinkage, as wool is quite elastic and when the tension is released, it tries to spring back to its original length. If it has been beaten too firmly, the fabric will be boardy.

To keep the web as nearly the full width of the warp as possible, leave the yarn as it comes from the shuttle diagonally across the shed, which allows for take-up. Of course, one can always use a stretcher, but I prefer to work without one.

When rolling the warp forward, pull it fairly tight, then let it off one or two notches so the warp is not stretched unduly. You will

get the feel of this after a while, and it helps to avoid shrinkage in the finished product.

Always measure with the tension slightly slackened.

After rolling the warp forward, always beat once before continuing the weaving. The threads are bound to loosen slightly in the rolling process, and need to be beaten back into place.

Naturally, it is very wasteful of expensive warp to set up your loom for only one article, as you need to allow one yard for loom waste. Therefore, it is better to set up for two baby blankets and a lap or carriage robe and even a bonnet. If there is enough warp left for a bonnet, 2 inches of warp threads can be removed in the center of the reed which divides the warp into two separate parts. A bonnet can then be woven on the right hand half, disregarding the warp on the left hand half. When the first bonnet is woven, it can be cut off. Wind the warp back so that the other half can then be woven, thus gaining two bonnets. The extra articles can always be used for gifts, but more often one can be sold and help carry the cost of the project.

I have developed what I call an **expandable** bonnet, details of which are to be found on page 8. Many people have told me they were able to use one of my bonnets until the baby was 4 to 6 months old, as it is made in such a way that the top turn-back can be rolled clear back to the elastic for the newly born baby and can be brought forward as the baby grows. It is difficult to buy a bonnet in the store that a new baby can wear.

Usually, when the bobbin of weft thread runs out the piecing is done at the edge of the material. However, when using Pompadour or any two or three ply yarn, it can be spliced and many times save almost a yard of weft yarn. To splice it, peel back two inches of one or two ply of the 3 ply on each end. Lay them overlapping in the palm of your hand and with the other palm roll them together, then pull into place in the material.

These blankets are all one shuttle weaves with the exception of the surface weave which requires a second shuttle for the Pompadour yarn. The background shuttle should be put around the Pompadour so as to carry it up the side of the weaving.

PROJECT NO. 1 — Two baby blankets, a bonnet and a carriage robe.

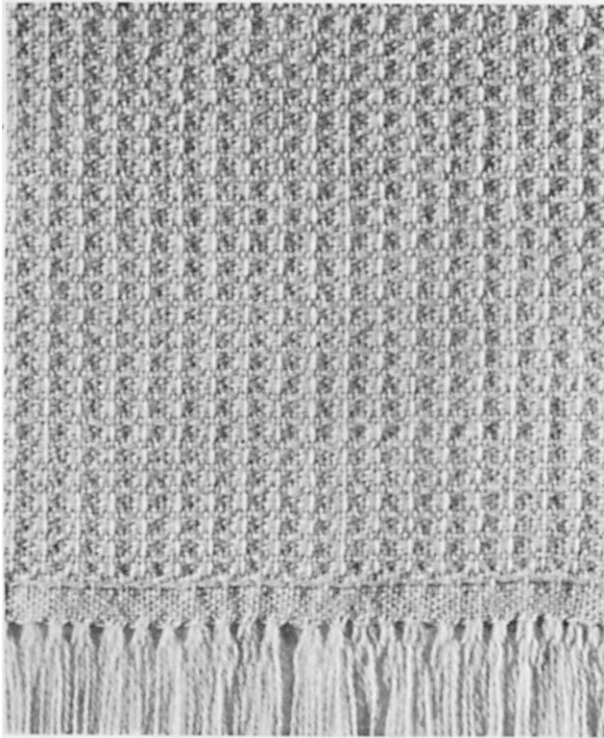

TEXTURE WEAVE

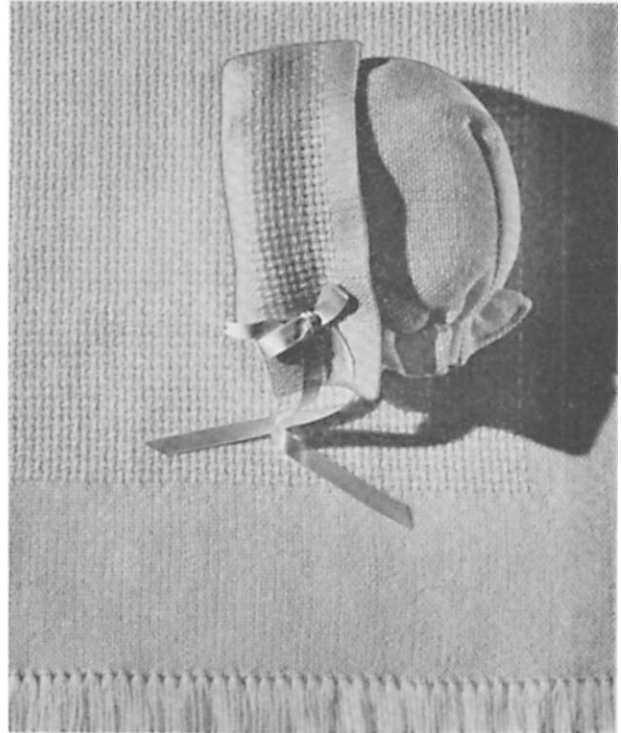

LACE WEAVE

MATERIALS:

WARP: Lily Art. 110 Weaving Wool 6 - 2 oz. tubes white
(510 threads 34" wide - 5½ yards long)

WEFT: Lily Art. 501 Mist Tone Pompadour 4 oz. pink - 1st blanket
Lily Art. 110 Weaving Wool 3 oz. white or yellow - 2nd blanket
Lily Art. 110 Weaving Wool 1 oz. white or yellow Carriage robe

NOTE: Because of the great elasticity in wool, and the tendency to stretch it when making a chain warp, I would suggest a 5½ yard warp, which will be close to 5 yards when taken off the warping board.

SETT: 15 dent reed, sleyed as directed.

Texture weave threading
 4 4 4
 3 3 3 3 3 3
 2 2 2 2 2 2
 1 1 1

Sley 1 per dent

NOTE: When threading leave 20 extra heddles on harnesses 3 and 2 which will be needed for threading the border for the next blanket.

Tie-up
 x o x x Counter Balance x
 o x o x
 o x x o Jack o
 o o o x
 1
 2
 3
 4 3
 3
 1
 2
 3
 4 3
 3

This threading was taken from a Swedish Book I Vavstolen No. 2

PROJECT NO. 1 Continued

Lace Weave Threading

```

      4      4
     3 3    3 3
    2      2 2  2
           1      1
  
```

Pattern as wide as desired

Plain Weave Border
(60 threads for 4" border)

```

      3 3 3 3 3 3
     2 2 2 2 2 2
  
```

Border as wide as desired

Tie-up

```

x x o o
x o x o
o x o x
o o x x
2 B A 1
  
```

Groups of 3 threads 2-1-2 threaded in 1 dent, leaving the two following dents empty. Next group of 3 threads 3-4-3 in 1 dent, leaving the next 2 dents, empty, etc. The border plain weave is threaded 1 in a dent.

TREADLING: Plain bands for border repeat A and B for desired width. If blanket is to be fringed just square the border corner. If blanket is hemmed back weave 3 inches more for hem. * If blanket is to be bound weave extra width of the binding. Lace weave A1A (1/3 1/2 1/3) B2B (2/4 3/4 2/4) for length of the blanket, then weave plain border as above. To have a blanket 40" finished it should be woven 45".

Weave 4" plain *
 37" lace
 4" plain *

 45"
 10" allowance for fringe or hem

Carriage Robe—The width of the warp would be the length of the robe.
 Weave 4" plain *
 18" lace
 4" plain *

 26"
 10" allowance for hem or binding

If blankets are to be fringed, it can be tied in groups of 6 threads, or it can be hemstitched on the loom. This makes a very pretty and smooth finish and is not lumpy like the knotted fringe. Hemstitching on the loom was explained in detail in Practical Weaving Suggestion, Vol. 2-'59.

PROJECT NO. 2 — Two baby blankets, two bonnets and a small carriage robe.



Surface Weave

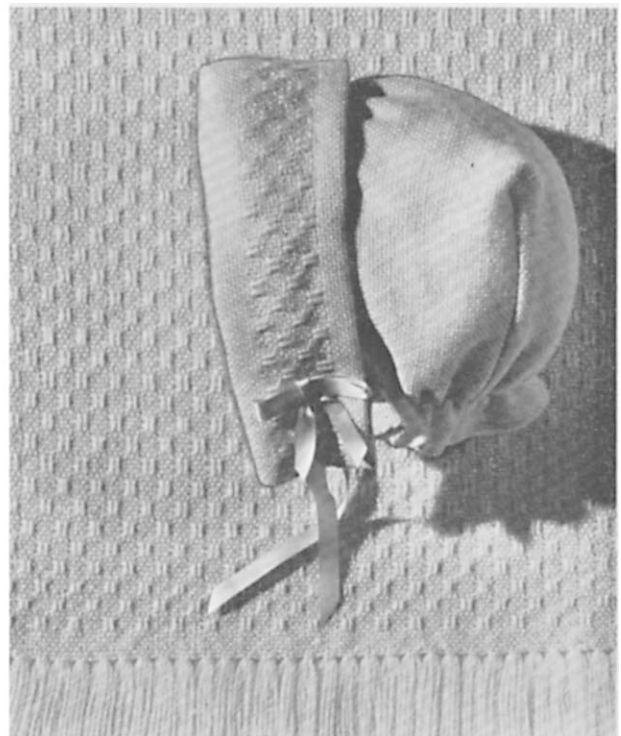

Huck Weave

PROJECT NO. 2 Continued

MATERIALS:

WARP: Lily Art. 110 Weaving Wool
(612 threads - 34" wide)

6 - 2 oz. tubes White for warp

WEFT: Lily Art. 501 Mist Tone Pompadour
Lily Art. 110 Weaving Wool
Lily Art. 501 Mist Tone Pompadour

2 - 1 oz. balls White
2 - 2 oz. tubes pink, blue or yellow 1st blanket
4 - 1 oz. balls pink, blue or yellow 2nd blanket

SETT: - 18 dent reed - 1 in a dent

SURFACE WEAVE — taken from the Davison book, page 59 Helen Schobinger.

```

      44      44
     33 *   33 *
    2 2 2   2 2 2   2 2 2
    1 1 1   1 1 1   1 1 1
  
```

Tie-up

```

o x o x o o 4
x o x o o o 3
o x x x x o 2
x x x o o x 1
  
```

```

A      B
      1
      1  1 - color background
      1
      1  • - White Pompadour
      1
      1
      1
      1
      •
      •
      1
  
```

NOTE — Be sure to start and end by threading on the 2,1,2,1,2,1
*Leave an extra heddle on harness 3 at *. It can then be easily re-threaded to the following blanket.



HUCK WEAVE — taken from the Davison book, page 60 Caroline Halvorsen.

```

    4 4      4 4
   3 3 3   3 3 3
     2 2 2   2 2 2
     1 1     1 1
  
```

```

o o x o 4
o x o x 3
x o x o 2
o x o o 1
  
```

```

A B
  1
  1
  1
  1
  1
-----
1
1
1
1
  
```

This block always starts on the right side.

This block always starts on the left side.

Remembering this will help to avoid mistakes in the weaving.

PROJECT NO. 3 — Three-tone Baby Blanket Set—a blanket, a bonnet and a carriage robe—may be pink, blue and white or mint, yellow and white.

MATERIALS:

WARP: Lily Art. 801 Baby Wool Yarn, 4 oz. mint green
Lily Art. 801 Baby Wool Yarn, 2 oz. yellow
Lily Art. 801 Baby Wool Yarn, 5 oz. white

WEFT: Lily Art. 501 Mist-Tone Pompadour, 3 oz. mint green
Lily Art. 501 Mist-Tone Pompadour, 2 oz. yellow
Lily Art. 501 Mist-Tone Pompadour, 6 oz. white

REED: 12 dent 1 thread per dent

THREADING: Twill but woven in plain weave

Plan for the warp— 48 threads Green
2 threads White Mist-Tone
24 threads Yellow
2 threads White Mist-Tone
12 threads Green
236 threads White
and reverse to top

Weave with the Pompadour until the colors are squared, then weave white center, then borders. After the colors are first woven, take a tape measure and pin where each color starts. If you intend to weave the blanket 45" long put a pin (tiny safety pin will not pull out) at 22½ inches. When you are past the center the

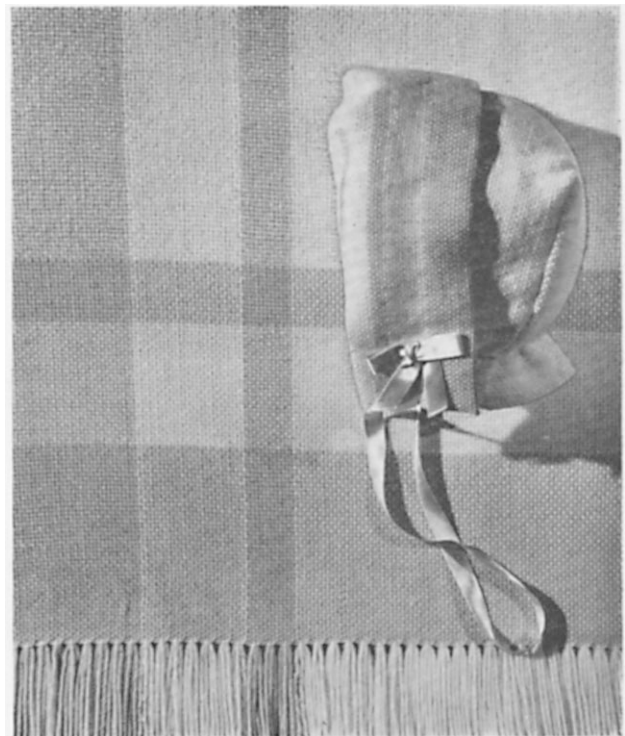

tape can be reversed and will show where the border on the other end will start, and the width of the color bands will be uniform.

A lap robe and bonnet can then be woven, after allowing for fringe or hem for the blanket.

PROJECT NO. 4 — A soft sheer blanket, bonnet and saque—

MATERIALS:

Lily Art. 111, Lightweight Weaving Wool,
6 2 oz. skeins Lt. Pink and 1 2 oz.
skein White

Lily Art. 114, Mercerized Floss, 2 2-oz. tubes
Lt. Blue 952

Warp Arrangement:

BORDER (left)

20 white
2 blue
18 white
2 blue
18 white
2 blue
18 pink
2 blue
18 pink
2 blue
18 white
2 blue
18 white
2 blue

CENTER

796 pink

BORDER (right) reverse left border beginning with 2 blue.

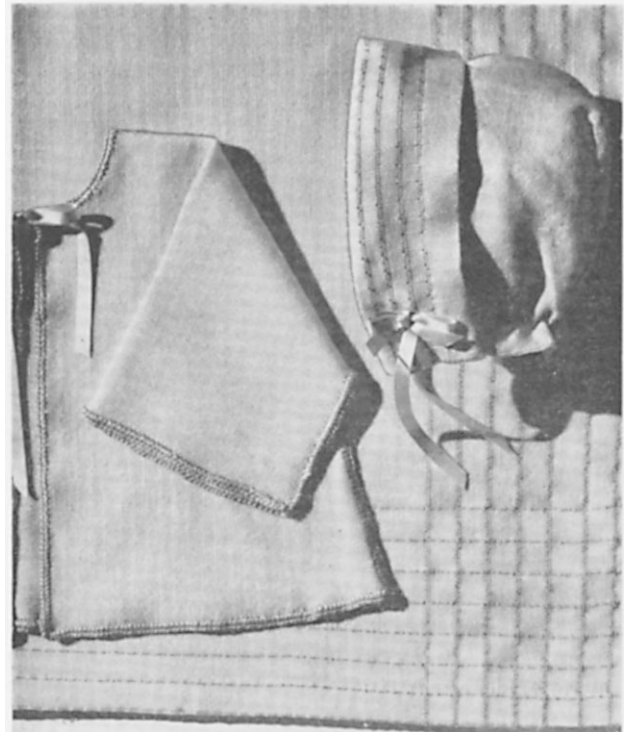

SETT: 30 per inch

REED: 15 dent - 2 per dent

THREADING - SURFACE WEAVE — Davison book, page 59 Helen Schobinger.

	44		44	
	33		33	
2 2 2	2 2 2		2 2 2	
1 1 1	1 1 1		1 1 1	

Be sure the 2 blue threads
always come on the last 2,1.

Treadle—Plain Weave - 1/3 and 2/4

Blanket—If hemming, weave 1 1/2 inches for hem
Square each block of color
Weave pink center
Square each block of color

Saque—Cut off border bands so that 24 inches of the warp remain of the all pink center. Weave 25 inches. Remove material from loom and steam press. Before cutting, outline pattern with pencil or chalk and machine stitch on that outline, cut and turn this stitched line and stitch again to give firm edge to crochet over. Trim close to double stitching and single crochet all edges.

Bonnet—Narrow warp to 15 inches. Weave as directed in bonnet instructions with 4 bands of blue in border.

DIRECTIONS FOR MAKING BONNETS

A piece of material 14 x 15 inches will make an average size bonnet. For this, you should weave 16½ inches on a 15 inch warp to allow for shrinkage when steam pressed. This allows 1½ inches for a hem and approximately 2 inches for a border trim.

To make bonnet:

1. Turn under and hem front edge by hand.
2. Clip lines E for about 3/4 inch toward F (dia. 1). Turn area between E and E to inside and hem by hand.
3. Fold material to inside from F to corner, matching E to D. (dia. 2). Stitch from F to E D and flat fell this seam. To do this cut off excess material, leaving 1/2" seam. Press seam toward the center back and trim under seam. Turn under raw edge of top seam and slip stitch by hand.
4. Using a long stitch, 8 or 9 stitches to inch, and Lily Elastic Sewing thread on bobbin, stitch a line about 10 inches long on top of bonnet just under edge of border-turn-back and around bottom of bonnet as shown in dia. 2.
5. Tack ribbon tie strings on each side of border turn backs.

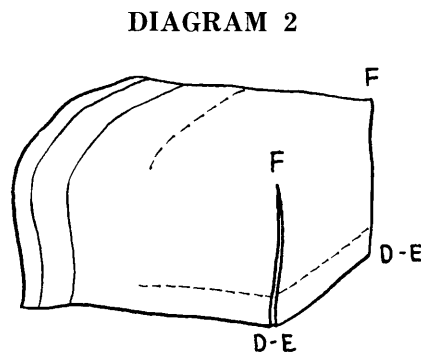
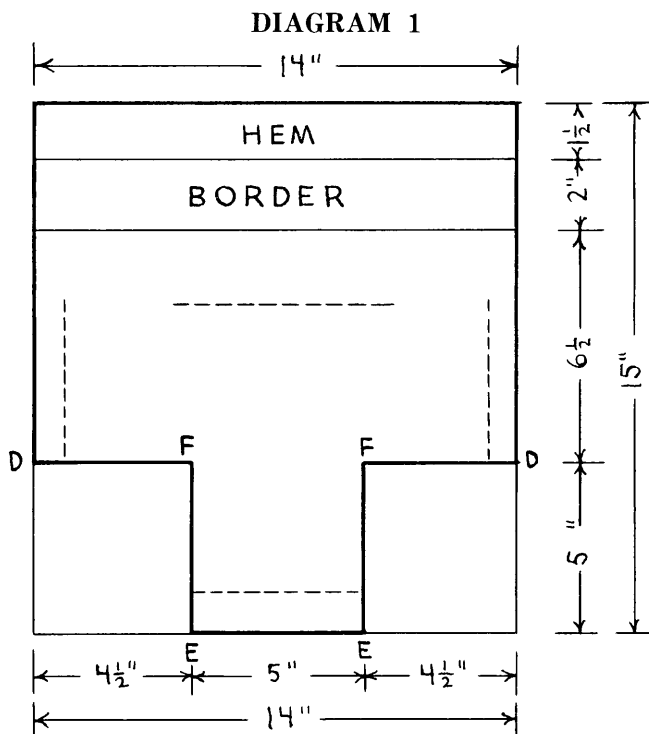

NOTE: Art. 801, Baby Wool Yarn, and Art. 501, Mist-Tone Pompadour, are not shown on handweaving price list but are available - write for free samples and prices.

The Handweaver's Headquarters
LILY MILLS COMPANY
Shelby, North Carolina