

THE MINNESOTA WEAVER

Volume 3, Number 2 October 1977

**COMING
UP**

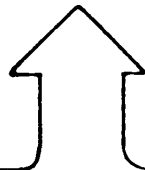

October Program Thursday, October 6, 1:00 p.m.

The October meeting will give us all an opportunity to become acquainted with some of the ideas circulating in the weaving and textile world. Several Guild members attended courses or conferences during the past year and they will report on their experiences.

Last March, Kathie Frank attended the Arts Marketing Conference sponsored by the Design Department at the University's St. Paul Campus. Present on behalf of the Guild, she attended talks pertinent to organizations. Setting up galleries, funding, cooperatives and publicity were among the topics discussed.

Sue Baizerman, Lotus Stack and Lila Nelson travelled to the Irene Emery Round Table conference in Washington, D.C., in April. This three-day meeting sponsored by the Textile Museum, entitled "The Loom and Its Products," dealt with looms of all types from their beginnings. Our members promise some interesting commentary on the tools of weaving, accompanied by slides. Lotus will deal with Asian looms, Sue with looms of the Western Hemisphere and Lila with European looms.

Lotus, in addition, will be returning from another conference in time for the October meeting. The CIETA (International Center for the Study of Ancient Textiles) annual meeting is hosted this fall by the Victoria and Albert Museum of London. Lotus will have a report for us on this conference also.

Charlotte Miller will show slides and speak about the conservation of historical textiles. She and several other members attended a Textile Conservation class held at the University this summer, taught by Nobuko Kajitani of the Metropolitan Museum of Art.

All told, there is much to be learned at this meeting from the interesting experiences of other members.

Debby Alper

OCTOBER EXHIBIT IN THE GUILD ROOMS

During the month of October, works by members of the Weavers Guild faculty will be featured in the display areas. A wide range of techniques, both loom woven and off-loom will be shown.

During the month of September, student examples from recent guest artist workshops were on display.

ART INSTITUTE CHRISTMAS TREE

Once again it is time to think Christmas!

The Minneapolis Institute of Arts has asked us to decorate their tree for the third consecutive year. Again we call on all of you to get out your odds and ends of yarns and come up with your piece for the tree.

This year we are looking for new ideas for objects to be made. If you have an idea that could be done in quantity, call Betty Olson who is in charge of planning the ornaments (869-8043); or come to the first Working Bee/Planning Session on Thursday, October 6, from 9-12.

We also hope you will be working on your special object for the tree at home. This year's color scheme is metallics and naturals—greens, browns and tans, plus copper and brass (not silver).

Remember that pieces you make may be reclaimed after Christmas to use on your own tree in future years. Pieces not reclaimed are sold at the next Fiber Fair. Pieces should be 4 to 8 inches in their largest dimensions.

We will also need large pieces to be placed under the tree as "weavers gifts." Any color will do, and objects may be functional or non-functional, in any technique.

Our tree has become a special tradition at the Institute, and we should be proud of the elegant trees we have done in past years. Help us out-do ourselves this year!

Charlotte Miller

Remember these dates for Working Bees:

Thursday, October 6, 9:00-12:00 (Work and planning session)

Thursday, October 20, 12:00-3:00

Wednesday, November 2, 9:00-12:00 and 7:00-9:00

Thursday, November 10, 9:00-12:00

NOVEMBER PROGRAM PREVIEW

Thursday, November 3, 1:00 p.m.

"Primitive Studies," a slide lecture by Grete Heikes

Grete Heikes was born and raised in Norway. She worked there as an apprentice weaver and studied many of the early looms and textiles of northern Europe. As part of her studies of fabrics from the bronze age to middle ages, she constructed exact copies of the Bog People garments. For three weeks she lived in Lapp villages of northern Norway and Sweden and studies upright warp weighted looms. This last summer she returned there for further exploration.

Grete will be giving a slide lecture of her background and its influence on her current work. One of her pieces executed in 1975 can be seen at the North Central Wool Mkt. Corp. in Minneapolis.

GUILD NEWS



OFFICE STAFF

Administrative Assistant.....Kathie Frank
 Educational Coordinator.....Sue Marcotte
 Secretary.....Margaret Pidde
 Office Assistant—Evenings.....Mary Liudahl
 Office Assistant—Saturdays.....Patt Keane

Hours: 9 a.m.—3 p.m.; 6 p.m.—8 p.m., Monday through Thursday
 9 a.m.—3 p.m. Fridays
 9 a.m.—1 p.m. Saturdays Phone: 332-7521

SUMMARY OF THE BOARD MEETING; SEPTEMBER 9, 1977

The Guild has received estimates in excess of \$50,000 on the remodeling of the Woolgrower's space. The necessary building consists of stairways, fire escape, storm windows, lowering of ceilings, partitions, two bathrooms, a dye laboratory and upgrading of wiring and heating systems. This works out to be about \$9 per sq. ft. A committee will negotiate with Woolgrowers to see whether they will accept responsibility for part of the remodeling.

The Fiber Fair will be held November 18 and 19. Chairman Kathy Martin needs ideas for fundraising items to sell and help in packaging stationery.

Betty Olson will be the chairman of the Guild Christmas tree at the Minneapolis Institute of Arts. She would like ideas for ornaments.

The State Arts Board turned down our grant proposal.

Patricia McHugh and Karen Searle will compile proposed by-law changes.

Many small properties are missing from the Guild, especially shuttles.

Fred Leach of Hamline University has requested that the Guild be open for visitors one afternoon during the Mid America College Conference at the end of October.

Due to deficiencies in past records, it will be impossible to compile a working budget at this time. Committee chairpersons will be asked to keep records in a different manner this year in order to remedy this situation.

Next Board meeting will be October 13 at 9:00 a.m.

STITCHERY/78 CORRECTION

There will not be a Fiber Fair-type boutique at Stitchery/78. Rather, items submitted to the show for jurying may be offered for sale with a small commission going to sponsors of the show, United Hospitals Auxiliary.

You may want to begin thinking now about what you wish to enter for jurying. Entry blanks will be available at the Guild later this fall.

Are you interested in coordinating demonstrators for the Stitchery/78 exhibit next April? Please leave your name in the office if you can help us.

TREASURERS REPORT

Assets:	April	May	June
Checking Account	9927.56	1618.29	302.97
Cash on Hand	—	—	674.61
Savings Account	10129.27	17629.27	17826.18
Petty Cash	35.00	35.00	35.00
Properties*	13205.80	13205.80	13205.80
Less Replacement Reserve	(2000.00)	(2000.00)	(2000.00)
Library	5696.99	5696.99	5819.34
Less Replacement Reserve	(541.14)	(541.14)	(541.14)
TOTAL ASSETS	36453.48	35644.21	34716.82
Liabilities:			
Federal WH Tax Reserve	154.80	232.80	195.40
State WH Tax Reserve	38.20	65.90	119.90
U.C. Tax Reserve	—	—	55.26
Sales Tax Reserve	—	—	—
Deposits on Loom Rentals	985.00	955.00	1110.00
Building Fund Reserve	349.46	349.46	349.46
Reserve for Prop. & Lease	25732.48	25732.48	25732.48
Reserve for Properties— this year	(9193.54)	(8308.57)	(7154.32)
TOTAL LIABILITIES	36453.48	35644.21	34716.82

Income and Expense Statement

Income:	April	May	June
Memberships	1052.50	475.00	520.00
Nonmember Fees	50.00	85.00	135.00
Tuition	2462.10	1508.00	2185.50
Workshops	—	—	—
Library	10.00	1.00	17.50
Loom-Wheel Rental	30.00	10.50	21.50
Sales w/Sales Tax	289.59	520.22	1167.41
Craft Sales-Fiber Fair	—	—	—
MN Weaver Ads	51.00	108.00	13.00
Interest	—	—	201.08
Miscellaneous	—	—	—
TOTAL INCOME	3945.19	2677.72	4260.99
Expenses:			
Salaries	1832.00	1177.00	2516.75
Salaries Reimbursed	—	—	—
U.C. Fund	—	—	55.26
Special Services	—	1551.11	(9.50)
Purchases for Resale	369.28	36.53	1510.21
Workshop	—	—	—
Program	164.35	100.00	—
Office	57.31	10.00	47.01
Printing	90.33	.97	314.45
Postage	—	(.61)	—
Rent	720.00	425.00	425.00
Advertising	35.25	—	—
MN Weaver	278.00	226.48	339.16
Telephone	43.46	37.31	47.89
Accounting	65.00	—	105.00
Insurance	879.10	—	41.00
Repairs & Mtce	14.13	—	1.00
Miscellaneous	8.10	(1.10)	8.90
Interest	32.43	—	13.11
TOTAL EXPENSES	4588.74	3562.69	5415.24
UNEXPENDED RESERVE	(643.55)	(884.97)	(1154.25)

REMEMBER THE GUILD CAMERA!

An instamatic camera was donated to the Guild for use in recording Guild activities for the newsletter and the history, and just for fun. Since we have no official photographer, you're all appointed unofficially. Use it to take snapshots during classes, meetings and workshops that you attend. The results can be on exhibit on a bulletin board each month, or used to brighten up the Weaver. The camera is in Margaret's custody in the office. For best results, use the flash attachment provided.

Guild Annual Membership	
Individual	\$15.00
Family	\$20.00
Sustaining	\$25.00 or more
Subscriptions to the <u>Minnesota Weaver</u> (for persons living over 100 miles from the Guild)	
	\$4.50 per year

NOTES FROM THE ADMINISTRATIVE ASSISTANT

With not-so-crisp September nearly behind us, we are deeply immersed again in Weavers Guild business. We have collected almost everyone back from vacation. The 1977 State Fair is a memory. Many thanks to the hardworking people who are responsible for our success at the Fair: Dorothy Nollet-Sańkey and Dorothy Christensen who arranged and over-saw the demonstrations during the 12 days of the fair; Shirley Herrick, Irene Wood and Patt Keane, who designed a project, ordered materials, warped and dressed the floor loom; and Dianne Swanson and Suzette Bernard who planned and collected woven items for the visual exhibit which the Weavers Guild shared with the University Design Department in the Creative Activities Building. The whole Guild is grateful for your skill in carrying out a massive task.

Plans for the Fiber Fair are well underway. The Fiber Fair Committee is looking for someone to arrange for items to be used by the Guild to raise funds (notepaper, cookbooks, cards, speciality items—we need your ideas). Please notify Pat Boutin Wald, Kathy Martin, or Linda Bouchard if you are able to help at the Fiber Fair in any capacity, or leave your name in the Guild office.

Christmas is already in the air with Betty Olson’s plans for October and November ornament-making workshops and working bees aimed at decorating the Minneapolis Institute of Arts Christmas Tree as we have done for the past two years. Come to the first working bee on October 6 at 9:00 a.m. with natural materials and/or yarns in natural colors, gold, and brass, and help us plan the rest of the sessions. Elsewhere in the Weaver is a listing of the Ornament Working Bee dates and times.

As most of you know, we are trying to find the Guild a larger and more permanent home. Help from anyone interested is welcomed either in the form of leads on available spaces, or as a Search Committee Member. We have begun to get bids on renovating space at the Woolgrowers in S.E. Minneapolis, but since there are potential hang-ups there, we are still looking elsewhere wide-eyed. We have Charles and Marje Pohlmann to thank for the countless hours they spent this summer on preliminary floorplans and construction bids.

At the October 6 meeting you will be asked to consider a Board request to empower the Search Committee to act on acquiring new property without a formal membership vote, as long as the following criteria are met:

- 4,000 to 6,000 square feet of space
- less than \$2 per square foot per year rent (more if utilities are included)
- easily accessible to Minneapolis and St. Paul residents
- near public transportation and with free parking available
- long lease (approximately 10 years, minimum) with some guarantee of rent stability.

We look forward to having all of you participate to a large degree in our Guild program this year. We want the Guild to be what you desire, so we need to hear from you!

Kathie Frank

PROPERTIES INVENTORY

Its inventory time for our Guild properties. The results have shown a lot of missing equipment such as:

- boat shuttles — 14 missing
- flat stick shuttles — 13 missing
- drop spindles — 16 missing
- warping clamps — 28 missing!

Please check your equipment to see whether you have inadvertently carried something off. In the future, please sign out items on the clipboard in the equipment room if you are going to take something home. Remember that its possible to take bobbins out of the boat shuttles, so that you can take your yarn home without taking the shuttle along, too.

Other equipment is missing too, but not in such quantities as the above items; let’s try to get it all back as soon as possible so we don’t have to repurchase it. Thanks.

Sue Mansfield
Properties Chairman

HELP WANTED

1. Someone to join with Fiber Fair committee; will concentrate on non-woven items which Guild sells to raise funds (note cards, notepaper, cookbooks, T-shirts, etc.) Call Kathy Martin, 922-3710 if interested.
2. Coordinator of demonstrators for Stitchery/78.
3. Coordinator of By-Member-For-Member Workshops this year; will work closely with Administrative Assistant, Kathie Frank; ideas already generated and teachers accumulated. Dates must be set, other arrangements made.
4. Hostess chairman to arrange for refreshments at monthly program meetings.
5. Additional members of the Library Committee to work with Chris Portoghese in making the library more serviceable to students and Guild members. Thinking help is needed—ideas—as well as mechanical help getting books ready for shelving. Call Chris afternoons or evenings at 645-7992, or leave your name at the Guild office.
6. Publicity Chairman for the Guild to coordinate publicity for major Guild events.

VISIT TO AWARD-WINNING WEAVER ARRANGED

Aurlie Butts, Minnespolis, won a sweepstakes placing at the State Fair on her exquisite Persian style rug, made on a loom designed by her and built by her husband. She has consented to have a group of interested weavers come to her home to see her loom and techniques. Those interested, please call the Guild office or Dorothy Christensen (488-2421) before November 1.



Our new Guild executives: Sue Marcotte, Education, left, and Kathie Frank, Administration.

WEAVERS GUILD COMMITTEE CHAIRMEN, 1977-1978

APPOINTED POSITIONS:

NOMINATING COMMITTEE- 3-5 people chosen by the president the February of her term of office.

REPORTING TO THE SECRETARY:

PUBLICITY:
NEWSLETTER: Karen Searle 636-0205
NEWSLETTER
AND CLASS SCHEDULE
MAILING: Evalyn Norby 788-1770
Natalie Adler 533-8390

REPORTING TO THE TREASURER:

PROPERTIES: Sue Mansfield 545-5568
Marjorie Jirousek 925-2296
FINANCE: Patricia McHugh 922-9500

REPORTING TO THE VICE PRESIDENT:

MEMBERSHIP:
BUILDING FUND:

REPORTING TO THE EDUCATION DIRECTOR:

EDUCATION: Nancy Haley 644-0811
PAID WORKSHOPS:

Kathy McMahon 226-8584
LIBRARY: Christine Portoghese 645-7992
(SLIDES): Karen Searle 636-0205
HISTORIAN: Edith Schultz 521-9521
GUILD
PROGRAM 1978: Pat Boutin Wald 331-8202

REPORTING TO THE OUTREACH DIRECTOR:

STUDIO EXHIBITS: Jean Lodge 483-1723
COMMUNITY
EXHIBITS: Verna Kaufman 925-3600
DEMONSTRATIONS:
Carolyn Golberg 374-5225

FIBER FAIR 1977:

Sarah Weld, Irene Meyers,
Pat Boutin Wald, Linda
Bouchard, Kathy Martin

STATE FAIR 1977:

Dorothy Nollet-Sankey,
Dorothy Christensen, Shirley
Herrick, Dianne Swanson

TRAVELING

EXHIBITS: Edith Glemaker 646-3173
OUTSTATE: Irene Wood 831-1126

REPORTING TO THE MEMBER AFFAIRS DIRECTOR:

STUDY GROUPS:

GROUP PROJECTS: Irene Wood 831-1126

Margaret Pidde

YARN CO-OP: Charlotte Haglund 335-7217

HOSTESSING:

BY-MEMBER-FOR-

MEMBER WORKSHOPS:

There are still a few openings on this list. If one of them sounds right for you, please contact Kathie Frank.

LIBRARY NEWS

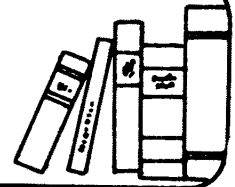

The Library Committee will meet in October to familiarize its members with the current status of the library, and to set goals for its continued development.

Traditionally, the primary goal of libraries has been service: the finding and giving of the best information available to the person who needs it. In order to accomplish this goal, the materials must be organized so they can be found easily.

This year as one of our first projects, we will be visiting other art and fiber libraries in the metro area to help us define the problems and the alternative solutions that concern us.

The Committee is still open to new members. For more information please call me at 645-7992, afternoon or evenings.

Christine Portoghese
Librarian

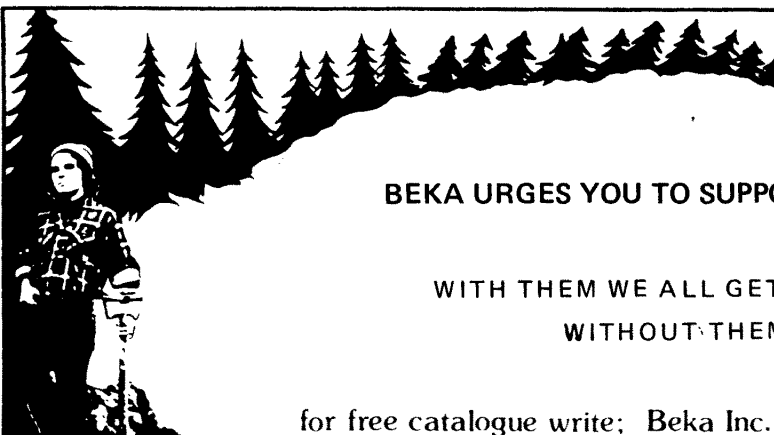

Beka Looms

BEKA URGES YOU TO SUPPORT YOUR LOCAL SUPPLY STORES .

WITH THEM WE ALL GET GREAT SERVICE AND SELECTION,
WITHOUT THEM WE WOULD ALL SUFFER.

for free catalogue write; Beka Inc. 1648 Grand Ave. St. Paul, Mn. 55105 (612) 222-7005

FROM THE PRESIDENT

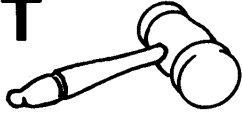

I'm going to be pushing and prodding for increased productivity this year among us all—more fibers spun, dyed, woven, felted, stitched, knotted—more results we can see, share, wear, give, sell, and use. We can add to the sum of beauty and softness and warmth in this world with what we make, and we can grow in the process.

In her book, *Centering*, Mary Caroline Richards writes, "There are many marvelous stories of potters in ancient China. In one of them a noble is riding through a town and he passes a potter at work. He admires the pots the man is making: their grace and a kind of rude strength in them. He dismounts from his horse and speaks with the potter. 'How are you able to form these vessels so that they possess such convincing beauty?' 'Oh,' answers the potter, 'you are looking at the mere outward shape. What I am forming lies within. I am interested only in what remains after the pot has been broken.' It is not the pots we are forming, but ourselves."

My own experiences working an idea and materials into finished form fall along these lines:

1. The piece is just what I envisioned and is a total and delightful success.
2. The piece is not what I envisioned but has unforeseen qualities that make it successful even though it doesn't match the original intent. Sometimes it's better than what I was attempt-

ing. And sometimes it takes another person's judgment to realize it, because I measure it by the image in my mind and see only what it is NOT rather than what it is.

3. The piece is a disappointment but I can see what is lacking or wrong and see ways to make the idea work better with another try at it, maybe a series of attempts before the idea evolves into something satisfying.
4. The piece is a colossal failure, leaving me depressed at having expended my time and yarn on it and making me doubt my ability. But even this is a sort of progress—an idea got moved out of my head onto the loom and now can be discarded, freeing me to go on to something new. The misspent time and yarn are called "tuition." I do learn from the failures. One of my fantasies is a session at the Guild to which we all bring our disasters and share the painful lessons. And laugh together.

It's time right now to produce for the Fiber Fair and to make gifts. If you are eager to get to work and don't have a backlog of ideas, some class or program at the Guild can provide fresh inspiration. As you proceed with your fiber creations, may you have more 1's than 4's.

Sue Obrestad

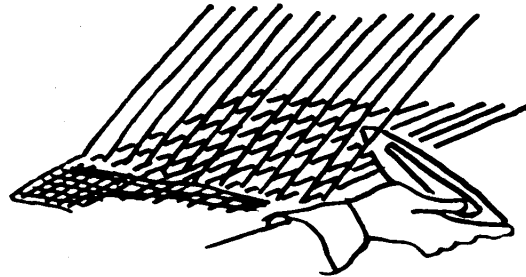

NEEDLES GALORE

DIAMOND HEAD MALL
BURNSVILLE MINN. 890-6110

LaVonne Horner and Randi Stritch

hours 9:30 am-9 pm; Sat. 9:30-6.

GRAND OPENING October 13, 14 & 15

specials:

Oct. 13,
10% off on all knitting
worsted, wool & acrylic

Oct. 14,
10% off on all hand-
painted needlepoint
canvases

Oct. 15,
10% off on all counted
cross stitch graphs
and fabric

INTRODUCING



LINDY WESTGARD, EDUCATION DIRECTOR

Lindy Westgard is always involved in some aspect of art education, both as teacher and student. She has taught art in the Roseville schools and in a special school for dropouts in Minneapolis, and quilt-making classes at the Creative Learning Center in Roseville. She joined the Guild in 1972 when she enrolled in the "Rug Techniques" class. This year she is taking design classes at the University.

A recent move from Lake Elmo to St. Anthony Park has put Lindy in the enviable position of being able to walk to her classes. After years on living 'in the country' with four children needing rides to their activities, Lindy appreciates her new location. She knows how easily the creative hours of the day can be spent in the car! The move entailed major remodeling and restoring of an 85-year-old house with Lindy supervising the construction every step of the way. With that completed she expects to have more time to design quilts and perhaps to weave the rug she's been carrying in her mind.

Sue Obrestad



HELEN VAN DEN BERG—PAST PRESIDENT

Helen joined the Weavers Guild in 1962 and since then has filled her personal time with taking and teaching many of the Guilds' classes. She is married, with two children, and three grandchildren. Her husband, Kent, is a Minneapolis attorney and concert cellist. Her home at 1725 Morgan is also her studio.

She has woven many of the necessary things for the home, such as draperies, table linens, placemats, rya rugs, coverlets and many others. All have a prominent place and inspire any weaver who has overlooked such projects.

Helen's favorite woven piece from the loom is the tapestry, for its technique she finds most satisfying and original. As a weaver, Helen remarks, "It is the doing it that give us the pleasure. The decisions and choices made in weaving are quite a privilege." She recognizes the variety in fiber talents that are making the weavers work today an ever exciting and intense experience.

Helen attended Smith College with a background in Art Education. She also has an M.A in Psychology from the University of Minnesota. Through her experience Helen remembers when floor loom classes were the only courses offered at the Guild. As the frame loom grew in importance, Helen saw it's portability catch on. The teaching of frame loom classes has made weaving more accessible to more people, anytime, anywhere. Helen's weaving has been both functional and free. She loves the challenge of loom weaving and is now in the process of weaving a ruana.

In order to encourage the future visibility of the Weavers Guild members, Helen hopes the Guild can publish detailed information about the procedures for entering many of the juried competitions in the area.

Mary Jane Severson

Help Wanted

If you have woven articles
you would like to place for
consignment sale, please contact

COUNTRY WEAVERS AND CRAFTSMEN

Rt. 2, Box 125
Chaska, MN 55318
466-2434

THE PIONEER LOOM

warp direct from cone onto loom
in a fraction of the usual time

threading or sett can be varied
during weaving

ideal table loom for samples



MARKETING ASSOCIATES

PHONE: 777 2657

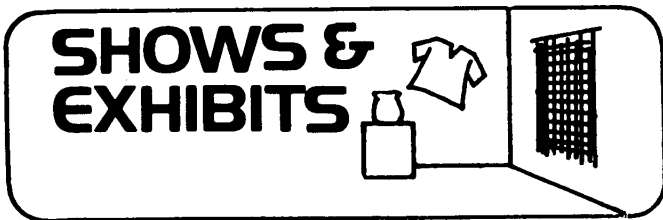

If you are going to exhibit your fiber works, or know other fiber artists who are, please let the Minnesota Weaver know so we can publicize it. We want to know about all exhibits, large and small, that might be of interest to weavers. However, we must have the information one month in advance of the exhibit date to publicize it properly. Keep us informed by sending exhibits notices to the Guild office, c/o Suzy Sewell.

STATE FAIR FINE ARTS EXHIBIT HONORS

Guild member Gerd Raich received two awards for the two fiber pieces she entered in the State Fair Fine Arts Juried Show. A Third Place Award and a Merit Award were given to her three-dimensional hangings of linen and wool. These pieces are the results of a technique she has arrived at through much exploration during the past two years, involving manipulations of the fabric after it is woven.

Gerd's work has been seen in four shows at Three Rooms Up in recent years. She has plans for executing some large-scale pieces in her as yet unnamed technique in the near future.

Other Guild members who had fiber pieces on display at the Fine Arts exhibit were Marilyn Herrmann, Lynn Hazelton, Charlotte Miller, and Mary Ellen Manning.

MIDWEST CRAFT COMPETITIVE EXHIBITION

The Rochester Art Center is sponsoring a competitive exhibition December 3, 1977, to January 1, 1978. Cash awards will be given for excellence. All Minnesota craftspersons are eligible to

submit up to three works in clay, fiber, wood, glass or metal. The entry fee is \$10 for up to three works. The entry form, fee, and slides are due November 5, 1977. Entry forms and additional information may be obtained by writing the Rochester Art Center, 320 East Center Street, Rochester, MN 55901.

WEAVING AT THE MINNESOTA STATE FAIR— CREATIVE ACTIVITIES BUILDING

Although there were fewer entries than last year, this year's entries in weaving at the State Fair were of very high quality, according to Judge Irene Wood. This year's Sweepstakes winner was Peggy Dokka's green and white coverlet. This award was based on the "perfect craftsmanship" of the piece and its well-designed joining and borders.

First prize blue ribbons in other categories were awarded to:

Barbara Fritzberg: lady's red vest

Sandy Holm: child's blue dress

Mary Liudahl: brown poncho

Elizabeth Reineke: Small overshoot cushions and white tablecloth

Marilyn Ricker: linen placemats with Spanish lace

Ina Rubenstein: blue yardage and prayer shawl

Ada Schroeder: dukagang hanging and natural dye tapestry

Ina Rubenstein's blue yardage won the first prize from the Wool Growers Association and Martha Gudmundson's scarf won the Wool Growers second prize.

Those of us who were able to attend the 1977 State Fair were able to appreciate the attention to craftsmanship, style, and detail in the prize winning pieces. All weavers are encouraged to begin planning their entries for next year's fair.

You may get a copy of the 1978 premium booklet by calling the State Fair office, 645-2781, after January 1 or writing the Minnesota State Fair, Falcon Heights, MN 55108.

Vävstolsfabriken Glimåkra Ideal. with counter-march



A compact floor loom, perfect when space is scarce. The loom and the bench are made of choice fine-grain woods and finished with clear varnish. The bench is adjustable in 8 different heights.

40 in - \$545.00 freight costs are extra

I have a shop where many models are exhibited and where we also sell looms and accessories. You are welcome to pay us a visit.

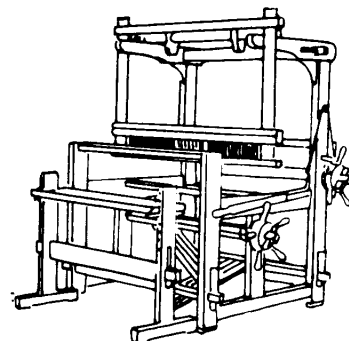

M. Susan Brock Ltd. 1838 St. Clair Ave. 612/699-1909
St. Paul, Minnesota 55105

SCHOOL NEWS

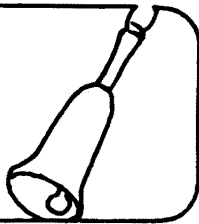

REGISTRATION FOR THE ART INSTITUTE PROGRAMS

The Weavers Guild is co-sponsoring with the Minneapolis Institute of Arts a series of one day seminars. The classes will be held at the Institute and will introduce students to the textile resources available in the museum. To register for these classes, simply send your check and a note about which class you want to take. If you are a member of either the Minnesota Weavers Guild or the Art Institute, the tuition is only \$20 so be sure to indicate if you are a member. Make your check payable to the Minneapolis Institute of Arts and send to:

Minneapolis Institute of Arts
Resource and Information Center
2400 Third Ave. So.
Minneapolis, MN 55404

The first seminar in this series will be given by Lotus Stack, the Textile Coordinator for the museum. **THE IMPRISONED THREAD: A HISTORY OF LACE** is the name of this seminar which will review the history of lace—drawn work, needle lace, and bobbin lace. The museum's collection will be used for examples and the class will get a chance to visit the museum's textile storage area. A luncheon is included in the tuition of \$20. This seminar is on Saturday, November 12, from 10:00—4:00 p.m.

SPOTLIGHT ON CLASSES STARTING THIS MONTH

Frame Loom II: Intermediate Skills Using a Frame Loom. This class offers a study of weaver-controlled weaves and laces, such as leno, Mexican and Spanish lace, warp bouquets and Danish medallion. Class starts October 11 for six consecutive Tuesday mornings and is taught by Cathy Ingebretsen.

Color and Design for Frame Loom Hangings I. If you want to feel more confident of your design skills when planning a project then this might be just the class for you. You'll learn more about the elements of design—line, form, texture, mass, shape and color as they relate to weaving. Pat Warner will teach this class for students with some weaving background. Class starts October 11 on Tuesday mornings.

Frame Loom Study Group. Have you been looking for a chance to really undertake a more in-depth study of frame loom techniques? Karen Searle will be leading a study group for serious weavers to meet twice a month starting on October 13.

Lace and Open Work. A chance to delve more deeply into hand manipulated lace. Mary Temple teaches this class on Wednesday afternoons, starting October 5.

Basic Spinning. The first spinning class on this year's schedule starts October 10. Pat Boutin Wald is the instructor for this class. Learn to spin with a wheel and a drop spindle.

Floor Loom I. Another introductory floor loom class taught by Sue Baizerman starting October 31.

Coverlets. This may be your last chance to take a class by Irene Wood! This exciting course will cover the history of coverlets, the use of profile, patterned double width cloth, twill borders, mitered corners, and traditional and modern uses of traditional drafts. Class starts October 31 and is a must for those who appreciate Irene's vast experience and talent.

Techniques in Handwoven Clothing. Learn to do something different with your loom. Weave a sampler of techniques used for making clothing on the Guild looms, and plan to do a complete project on a second loom. Class starts October 25 and is taught by Rose Broughton.

Bobbin Lace. More classes on lace! This one taught by Lotus Stack. Starts October 31.

Cardweaving. This class teaches the basic techniques of the ancient craft of tablet or card weaving. You don't need a loom for this one! Char Miller teaches this class starting November 1.

The new 1977—78 Class Bulletin has more details on all of these classes and more—plan your schedule now so you don't miss that class you've been wanting to take for a long time.

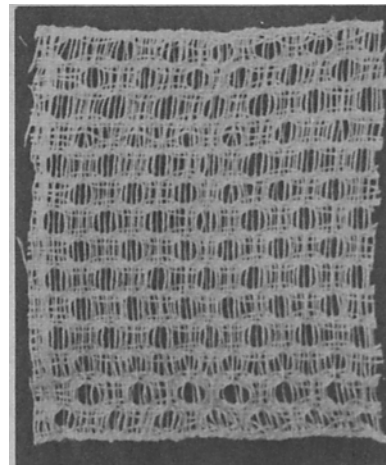

Doup Leno—workshop sample by Marj Pohlmann.

Compare this with Peruvian lenos p.10-12.

KEN WEAVER WORKSHOP

Ken Weaver obviously felt right at home in Minnesota this summer with all his friends and acquaintances from past workshops. In August of this year he gave a two-part program on loom-controlled leno and a geometric weave that he developed several years ago.

Leno is usually used in a spaced warp with the twisting of the warp preventing the warp and weft ends from slipping. The twisting in loom-controlled leno is achieved by a doup which is an extra thread tied onto the loom in such a way as to twist the warp automatically when certain sheds are raised. Marj Pohlmann took this technique and kept on expanding it into some lovely panels of leno samples.

The last part of the week dealt with Ken's geometric weave. It is a weft-faced, reversible block weave. Horizontally there can be only two colors but vertically the colors can be changed or shaded as much as you like. Again this is basically a loom controlled weave with the design coming from the different blocks that have been threaded on either 4, 6, or 8 harnesses. Everyone caught on to designing with the blocks and working out the many tie-ups, we had a great time experimenting with our linen warps. The designing was so much fun that I even took my graph paper in my backpack on our canoe trip the next week! Anyone interested in having Ken Weaver come back for a repeat of his rep workshop? Please let me or the office know!!

Mary Johnson (646-8198)

DISCIPLINE AN IMPORTANT FACTOR FOR KEN WEAVER

During the workshop, Ken Weaver expressed an attitude of self-discipline toward his work. The importance of setting goals for oneself was stressed; Ken's personal goals often relate to time. How much of a specified weave can be produced in one day? The answer to this question will help him in scheduling his work and establishing his prices. Often the time goal will push him to new and faster ways to produce an effect. With the volume of work increasing, Ken needs to work more quickly, but to produce with the same quality of craftsmanship. So far, he has found the use of assistants unsatisfactory as their work does not reach his standards of quality and performance. Thus pieces are exclusively created by Ken and his wife Mary. Another goal is the structuring of time. An allotted number of hours each day are spent in weaving, designing, client contact, etc. A project is planned so that the total production time is divided evenly between the days available for weaving. This way there are no last minute rushes. If all this process sounds mechanical, the product is not. Ken does claim a division between pieces which are decorative—the response to an architect's or designer's specifications—and those pieces which are personal expressions. "To be an art form, a piece should have presence." His recent pieces in this vein have much more dimension than earlier work. An example is the 8' x 8' wall installed at the Detroit Civic Center.

Mariorie Pohlmann

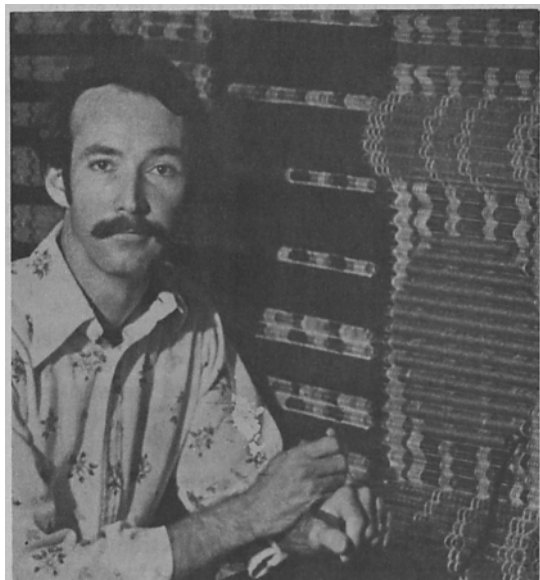

Ken Weaver one of our favorite guest artists.

STUDY GROUPS

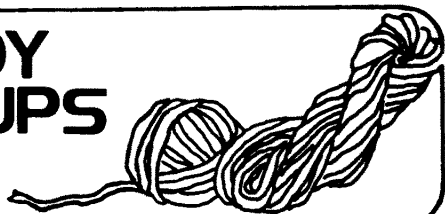

We don't need to look very far beyond the West Bank in Minneapolis to find small "guilds" of weavers and spinners. In a quick survey, I heard about at least 12 groups in the Twin Cities, some organized as long ago as 1970, a couple just forming this autumn. Some are open to anyone who wishes to join; others are full, the total membership dependent on how many spinning wheels will fit into a normal home's living room or how many frame looms can be attached to a dining room table.

In these times of fuel conservation consciousness, some of the study groups have formed in particular regions: Prospect Park Weavers, the Wednesday Weavers of St. Anthony Park, the North Suburban Weavers. Others are city-wide, encompassing anyone who wishes to weave on a single project, technique, or type of loom, Adele Cahlander conducts a monthly teaching study group, open to anyone who has a fairly good working knowledge of Bolivian Weaving. The Hamline Weavers developed as a result of a frame loom class at the Guild which decided they didn't want to disband after the class had finished. The Original Double Weave Group began in about 1970 as a group of weavers who wished to devote their year to studying double weave, and has gone on to other topics: to lace weaves last year, and Summer and Winter this year. Another group in the Roseville area chaired by Bunny Maki began studying Summer and Winter two years ago, and overshot last year.

In every case I have investigated, I have found these study groups to be tremendously productive. The Prospect Park Weavers and the Wednesday Weavers jointly hold a sale of their work every October (October 8 and 9 at 201 Cecil Avenue S.E., Mpls, this year). The Wednesday Weavers also have a Spring-time potluck dinner when they display the numerous products of their hands as well as the results of their groups' project (a color study one year, wall hangings last year). This tradition began as a challenge by the Wednesday Weavers' husbands that they were wasting their Wednesdays—nothing productive was coming of the sessions! The Roseville study group requires a project at the end of each year executed in the technique studied that year, in order to continue in the group the next year. This is true also of the Original Double Weave Group.

This autumn two new groups are forming. One is "Using Your Homespun" with monthly meetings alternating between color in homespun, and fiber differences. Specifics of homespun, problems of working with it, its different appearances, and control of various homespun results will be some of the topics covered. Pat Boutin Wald (331-8202) and Kathy Martin (922-3710) are the organizers. They invite any spinner with a wheel to join them.

A Knitting Study Group, one year old already, but reorganizing anew this autumn, is an outgrowth of the Mary Walker Phillip's workshop at the Guild. New members of this study group must know how to knit. The first meeting is at Pat Boutin Wald's house, 3132 4th St. S.E. (331-8202 for directions), will combine planning for the year with a discussion of Pat's and Kathy Martin's participation in Elizabeth Zimmermann's week-long workshop at Shell Lake, Wisconsin, this summer. Bring any knitting you have been doing and your calendar. The group will base the year's projects on Mary Thomas' Knitting Book and Pattern Book.

As if this weren't enough, there are three spinning groups which gather monthly for their own small "spin-ins." A new one in Golden Valley area I hear is open to new members.

Next month, the Minnesota Weaver will publish a list of study groups which have openings, and their contact people. If there are any groups I have not mentioned, please let me know who you are, what your project is, and how you can be joined, even if you presently do not have openings. We are interested in any study group studying any fiber technique, spinning technique or natural/chemical dyeing.

Kathie Frank

Please remember to return your library books on time.

TELAS DE LOS MUERTOS

CROSSED WARP WEAVES by Sue Baizerman

photos by Karen Searle

Last month the ancient Peruvian technique of knotted weft wrapping was discussed. That technique was noted for its use in creating an open, airy fabric. The more typical and better known form of Peruvian openwork is that which comes under the category "gauze weaves," or as Irene Emery in her Primary Structures of Fabrics calls them, "crossed warp weaves." Best-known are those gauzes which portray animal or geometric motifs executed in the same yarn used in knotted weft wrapping and very similar to them in size and overall impact. Like the knotted weft wrapped pieces, this airy, lacy type of gauze weave comes from the Central Coast area; the archaeological area of Chancay is particularly famous for production of this type of fabric. However, there are other gauzes from many other Peruvian archaeological sites which are quite different from these better-known gauzes. These latter are much more dense and would not be confused with lace.

Unlike the knotted weft wrapping, gauze weaves are found the world over. Tarascan lace from Michoacan, Mexico, is a particularly outstanding and elaborate example.

The Science Museum's collection contains nine examples of Pre-Columbian Peruvian gauze weaves. Three pieces appear to be originally from one textile. These three specimens and the other six in the collection are of such diverse applications of the principles of the construction of gauze fabrics, that each will be discussed individually. First, however, a more general discussion of fabric structure and materials.

The Structure of the Fabric

Like knotted weft wrapping and other plain weaves, the gauze fabrics are comprised of warp and weft. But unlike plain weave, there is a change in the spatial relationships between the threads: warp threads cross and recross one another. They are no longer strictly parallel (though they ultimately return to their original positions in the warp). (See Fig. 1.) Essential to the crossing and recrossing of the warps is the weft—it maintains the shifts taking place in the warp ends.

According to Emery, there are two basic types of gauzes, simple and complex. They will be discussed as they relate to specific museum textiles.

Materials

Like the textiles discussed last month, all of the gauze weaves in our collection are composed of cotton yarns. The white cotton is single ply, "S" twist. The brown cotton is 2-ply, "Z" spun, "S" plied. The yarn is overspun, sometimes to the extreme. Wool is used for patterning threads and for the weaving of borders in contrasting techniques; it is normally very loosely spun and plied.

The Fabrics

1. A-76-18-6 : This textile is a 30" x 32" all white, all cotton rectangle. It is composed of two rectangles seamed together, each a four-selvage cloth. At each end of each rectangle there is a half inch of plain weave, weft-faced. In between these end sections there is a plain 1/1 gauze. This is a simple gauze—two warp ends and two weft passes complete the whole fabric structure. This type of cloth is illustrated in Fig. 1a.

The cloth feels as if it could have been produced last week—it is soft and pliable. Yet the yarn is clearly handspun, over-twisted, and of an incredibly even quality; it is a perfectly crafted piece. There are approximately 25 warp ends per inch and 17 weft passes per inch.

In order to execute this type of plain gauze weave, first a plain weave shed must be opened, a shed where the extreme right-hand thread is raised (see Fig. 1:1). The first lower thread is brought under the first raised thread. Then the next lower thread is brought under the next upper thread and so on. As threads are crossed they are placed on a pickup stick (Fig. 1:2). When the whole row has been worked, the pickup stick is turned on edge and the weft inserted.

In plain gauze weave, this simple crossing of threads is uncrossed by making the plain weave shed opposite from the one used to make the crossings. Threads are then back in their original positions. These two sheds, one to cross the threads, one to uncross, constitute plain gauze weave.

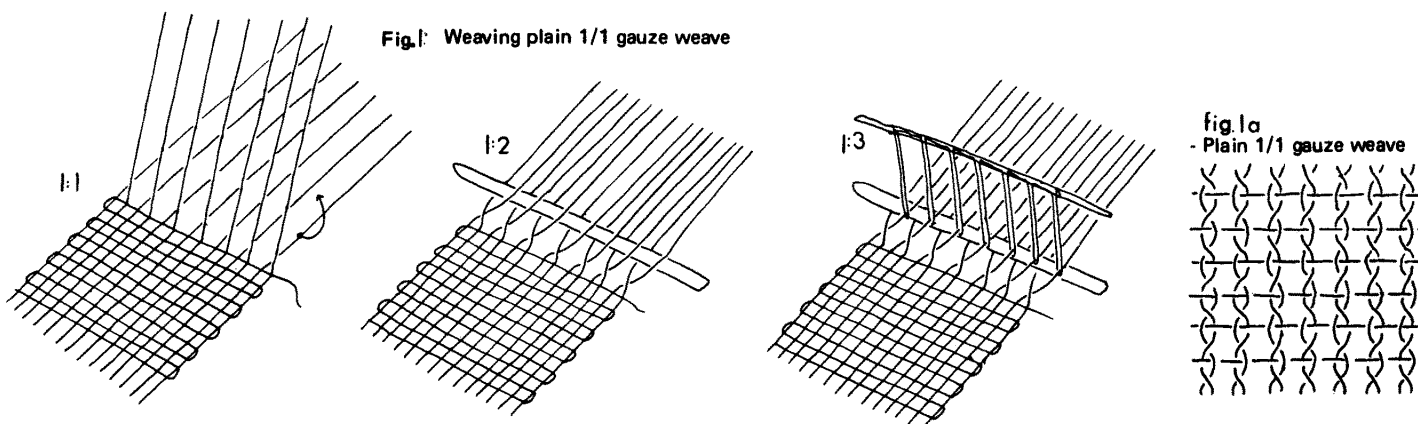

If an entire fabric is to be composed of plain gauze weave, the weaver may decide to use a string heddle to cross the threads. String heddles would be attached to the threads at the time they are crossed and on the pickup stick (Fig. 1:3). On subsequent rows, when the warp ends need to be crossed, the heddle stick is raised and crossing is accomplished automatically and with great time savings. In all likelihood this museum textile was woven with string heddles.

The heddle controlled thread crossing can only be used when a simple plain gauze is the desired result. If the threads shift from the vertical alignment shown in Fig. 1, the crossing and recrossing must be done by hand.

2. A 71-12-3: The second gauze weave textile differs from the first due to the presence of supplementary threads. The ground cloth is a plain gauze weave, in cotton, 2-ply, brown yarn (22–26 warp ends per inch; 6–7 weft passes per inch). The supplementary thread is a two-ply, softly-twisted wool. There are 12–14 insertions of this supplementary thread between the ground weave weft passes.

The supplementary thread would probably have been added most easily while the cloth was on the loom. This could have been done with a needle while the cloth was under tension. Or it could have been done after the cloth was removed from the loom, as in more traditional embroidery. Another possibility would have been extra heddles applied to the loom to create the over2/under 2 course of the supplementary thread. In this case we would have to call this thread a supplementary weft. Note that the supplementary thread interacts with the two thread gauze unit (see Fig. 2).

As Photo 1 indicates, the contrast in texture between the open gauze weave background and the dense tapestry-like supplementary threads produce a cloth of great visual appeal. Other factors add to the appeal: the interaction of colors (shades of red and gold on a dark brown background); the rhythmic interlocking bird motifs; the tasseled borders.

This narrow (4½" x 16") panel was probably a border on the lower edge of a garment. Three selvages are intact.



Photo 1 – A 71-12-3

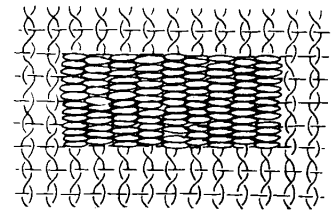

Fig 2- Plain gauze weave with supplementary thread patterning

3. A 74-16-26: In Peruvian textiles, one may also find alternating plain gauze weave (Fig. 3). Here, the same two threads do not repeatedly cross and recross; they do not stay in vertical alignment. Instead, the two thread unit is divided and forms a new two-thread unit.

The textile now under study combines a plain gauze weave with an alternating gauze to create a pattern (Photo 2). This is essentially a block pattern bordered by two threads which first join one block, then another.

This particular textile is unusual because it has a white warp (sett at 18 ends per inch) combined with a brown weft (7 passes per inch). Such color contrast in warp and weft is very unusual in Peruvian textiles. This piece is in good condition, supple and bright, with only a few holes. Like the textile above, its beauty is enhanced by contrast, this time between the gauze pattern and the complementary weft patterning on the borders. The latter patterning is executed in three colors; red, white, and black; and is non-reversible. Interestingly, the very thick borders are woven on the same warp as the delicate gauze!

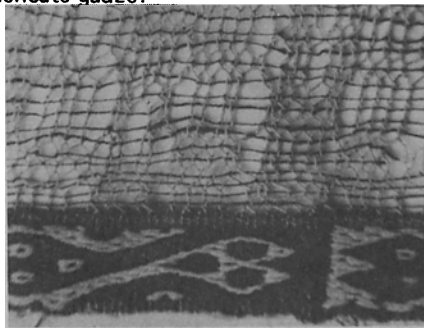

Photo 2 – A 74-16-26

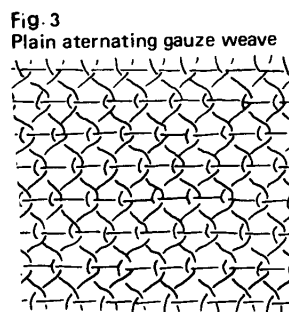

Fig. 3
Plain alternating gauze weave

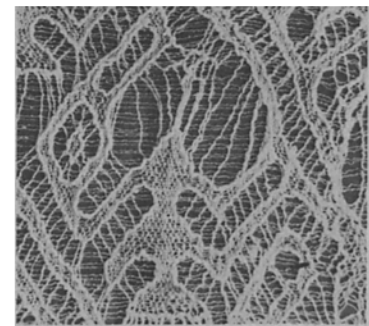

Photo 3 – A 76-17-8

4. A 76-17-8: The ancient Peruvians were particularly famous for their elaborate gauzes which portrayed animal and geometric motifs. This textile (photo 3) is such a good specimen, with beautiful bird forms combined with geometric ones, that it is very reminiscent of knotted weft wrapping (see back cover, September issue, Minnesota Weaver). It measures 32" x 40" and is made up of two 20" panels seamed together.

Like the textile described just above, this cloth's design is formed out of the contrast between plain gauze and alternating gauze weaves.

When we museum workers first noticed this specimen, it was simply a mass of cotton threads, seemingly undistinguished. It was only after careful unfolding that we discovered this exceptionally beautiful textile. It has many large holes and stains but the cloth that remains is of an exceptionally high quality. Yarns are extremely fine and overspun to such an extent that the design is obscured until the cloth is gently stretched. (Whether this is intentional or not is an interesting question.)

5. A 76-17-2; A 76-17-14; A 76-17-15: Because of the similarity of design, thread count and diameter, and correspondence of cut ends, we have concluded that these three cloths were probably originally one cloth. The projected cloth would be of a similar size to the ones discussed above. They are woven with very fine, white cotton yarns (38–40 ends per inch; 26 weft passes per inch); very well crafted.

In the cloths described thus far, a single thread has been crossed and recrossed around another thread. In this cloth, two threads are crossed and recrossed around two others (see Fig.4). It is executed in the same manner as plain gauze. The shed is opened with the farthest right thread up. Then the first two lower threads are brought up and placed to the right of the first two upper threads. The crossing and recrossing is done at selected intervals yielding the pattern of concentric diamonds; in Fig. . each "x" indicates where the crossing is done.

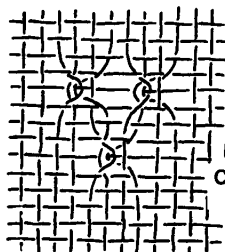

Fig. 4 –
Complex gauze weave



Fig.4a pattern diagram

6. A 72-24-12: This textile differs from those so far discussed because it is a more identifiable garment—a vest or “vestido”—composed of two long rectangles. These two rectangles are joined at the sides up to the armholes and down the center except for the neck opening. The piece measures 26” x 29” and is woven 50 warp ends and 15 weft passes per inch.

This garment demonstrates the use of gauze weave in a dense fabric: it is only upon close examination of the fabric that one can distinguish the gauze pattern. Like the textile above, it is a diamond pattern but it varies from the concentric diamond format of the previous textile. Photo 4 will clarify the difference.

As with the second and third textiles described above, the visual appeal of this textile is enhanced by a border of contrasting fabric construction, woven on the same warp. A supplementary weft pattern of cat motifs is used. Colors and textures of the border contrast with the gauze-woven portions. In addition there is a fringed tape sewn to the lower border of the garment.

The gauze pattern employed here brings four threads from the lower threads up under four threads from the upper threads, another simple variation from plain gauze weave.

The faint diamond pattern in the gauze weave is emphasized by embroidery outlining the diamond pattern. (The embroidery stitch utilized is the twined double-running stitch.)

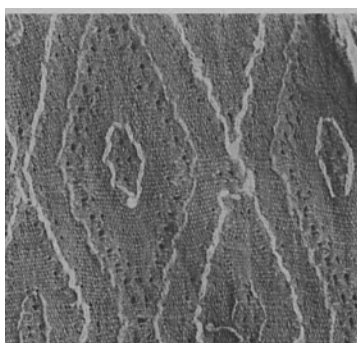

Photo 4 – A 72-24-12

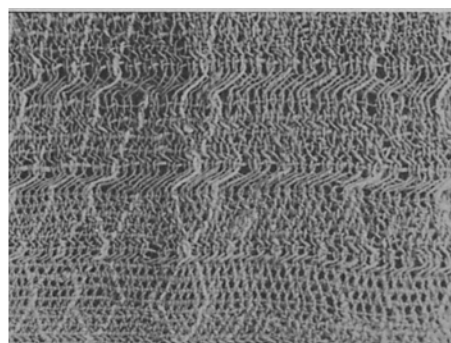

Photo 5 – A 72-23-2

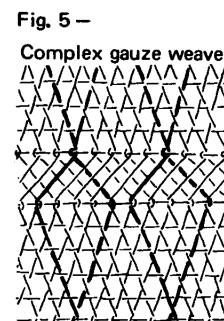

Fig. 5 –
Complex gauze weave

7. A 72-23-2: In this complex gauze weave, color is introduced into the warp, making it in this respect unlike any of our other crossed warp weaves. As the weaving progresses, these colored threads are diverted, then returned to position, creating a small, all-over diamond pattern and an interesting texture (Fig.5).

In preparation for weaving this cloth, the warp would be arranged as follows: 8 brown threads (2-ply brown cotton), 2 threads of another color (shades of gold and red wool), repeat. To weave, five weft passes would be made in an alternating gauze weave structure. These are woven without the usual alternation with plain weave sheds and warp threads are therefore not returned to their normal position with every other weft pass. On the sixth passage of weft, the plain weave shed is finally brought forward, returning the warp ends to their original position. This succession creates a periodic heavy diagonal patterning in the cloth (see Photo 5). You will notice that threads do not cross and recross except for the first and sixth weft passes, but rather interlace as in plain weave, but on a diagonal.

This textile is in very poor condition, having many large holes. It measures 24” x 28–31½”.

Similar to the vestido described above, there are approximately 26 warp ends per inch and 6–7 weft passes per inch. This higher warp to weft ratio results in a denser cloth.

For the Handweaver: We hope that the above descriptions will stimulate you to experiment more with the crossed warp weaves. For more information refer to Hilary Chetwynd's article in the Summer, 1974, issue of Shuttle, Spindle and Dyepot, “Experimenting with Leno Weaves,” and Baizerman and Searle's Latin American Brocades, as well as the Tidball monograph on Two Harness Open Work Weaves.

SPECIAL EVENTS

MIA TO OPEN TEXTILE STUDY ROOM

On the third Friday of each month, beginning in November of 1977, The Minneapolis Institute of Arts' Textile Study Room will be available for use by serious textile students and fibre artists. Appointments must be made in advance.

On Friday, October 21 at 2:00 p.m., there will be a one-hour slide presentation in Pillsbury Auditorium briefly covering the scope of the Institute's textile collections and the facilities of the textile study center. Individuals who plan to use the study room in the future are encouraged to attend this program. We especially urge teachers to take this opportunity to become familiar with the facilities the Institute can and cannot offer at this time.

There is no charge for the program. However, there is a \$1.00 donation museum entrance fee for non-MIA members.

Lotus Stack
Coordinator of the Textile
Collections

THE MINNESOTA WEAVER

Editor..... Karen Searle
 Feature Editor..... Mary Skoy
 Art Editor..... Dianne Swanson
 Advertising Manager..... Norma Rivkin
 Typesetter/Proofreader..... Suzette Bernard
 Photographers..... Rose Broughton, Jay Magoffin, Char Miller,
 Karen Searle
 Artists..... Sue Baizerman, Pat Boutin Wald, Curt Engstrom,
 Barbara Fritzberg, Lynn Marquardt, Kathy McMahon
 Columns: From Woods and Fields..... Connie Magoffin
 Guilds Elsewhere..... Kathie Frank
 Shows and Exhibits..... Suzy Sewell, Mary Jane Severson
 Spotlight..... Lis Jones
 The Rigid Heddle..... Cathy Ingebretsen, Gloria Rither,
 Mary Skoy, Dianne Swanson
 The Swatch Page..... Joy Rosner
 Telas de los Muertos..... Sue Baizerman, Suzy Sewell,
 Karen Searle
 Reporters: Coming Up—Debbie Alper; Guild News—Kathie Frank;
 School News—Sue Marcotta; Library News—Christine Portoghesi;
 General News—Pat Boutin Wald, Cathy Ingebretsen, Lis Jones,
 Char Miller, Sue Obrestad, Bev Skoglund, Mary Temple, among
 many others.

All items submitted to the Minnesota Weaver should be in writing and sent to the Guild office. Material is due on the 10th of each month for the following month's issue.



the Yarnery

1648 Grand Ave. St. Paul, Mn. 55105 (612) 690-0211

Just Arrived!

CUM ²⁰/₂ worsted

in 2 ounce pull skeins at our

**Grand Avenue & Leisure Lane
stores.**

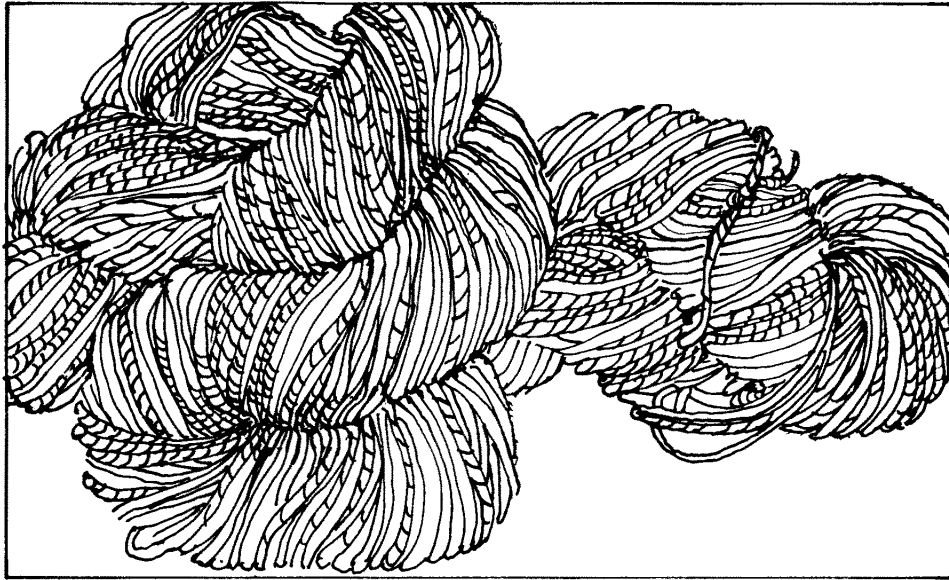

For
1001
YARNS
and more.

depth of field/earth works

405 CEDAR AVENUE
MINNEAPOLIS, MINNESOTA 55454

To order call 339-6061

BULLETIN BOARD

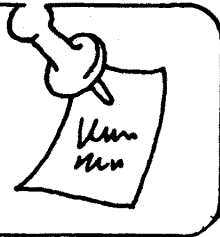

BOOKCASES NEEDED

Some additional bookcases are needed for the Weavers Guild library. If you have any bookcases you would like to see at the Guild, please call the office (332-7521).

FLEECE FOR SALE

The Guild has some fleece for sale in ½ lb. bags at \$.45 and \$.55 per half-pound, depending on quality and cleanliness.

ALUM FOR SALE

The Guild has alum for natural dyeing for sale at \$.50 per lb., packaged in one, two, or five pound quantities.

LOOMS FOR SALE

4-Harness Dean Automatic Fly-Shuttle loom, 45" wide. \$3300 or best offer. Kathy Schoenfelder, Waverly, MN, 1/658-4740.

New 40 inch jack loom, 4-harness, 6-treadle, sectional beam, plus warping board, \$550. Pat Cowley, 339-6400 days, 291-7487 evenings.

4-Harness Leclerc Artisan with homemade bench, \$275. Patt, 339-6977 or leave message in office.

Navajo loom, hardwood construction, excellent condition, \$15. Patti, 890-9543 after 6.

Navajo loom, pine \$20. Carol Henn, 2453 Garfield S., Mpls, 874-0069.

Hardwood loom with 4 whalyacalits riding up and down on some kind of counterbalanced gizmo. Seems to the layman to be in good operating condition. (4-harness, 4 treadle, 22") Tim, 336-9490.

RAGS FOR SALE

100-125 lbs clean rags; variety of fibers, price negotiable. Dorothy Swingley, 722-0240.

MOVED?

Please send your new address and phone number to the Weavers Guild Office. Corrections and additions to the Membership Directory will be published in the Minnesota Weaver.

WANTED

Mrs Odell (Odell Nursing Management), 571-2363, wants rug loom with sectional warp beam, 2-harness.

An electric coffee pot or other appliance for making small amounts of coffee or tea during Guild classes.

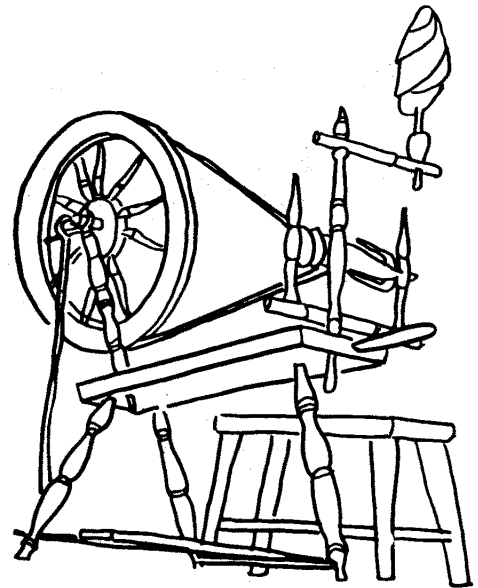

ATTENTION: STATE FAIR WORKERS

We are grateful to all of you who helped to make our booth at the State Fair a success. It is very costly to mobilize such a large working force, however. Please remember to reimburse the Guild for your admission ticket.

NEED A FLOOR LOOM FOR THAT SPECIAL PROJECT?

Guild looms can be rented for the low rate of \$1 per day or \$5 per week when not in use for classes. Call the Guild office for information.

MEMBERSHIP DIRECTORIES

The current membership directory is available in the Guild office. Please pick up your copy the next time you are at the Guild. If you wish to have it mailed to you, please send \$.25 in stamp or coin to cover postage.

Please remember to return your library books on time.

stoneflower



Featuring functional
handcrafted designs from
the midwest's leading
professional craft people.

1694 grand avenue
st. paul

Weaver's Guild of Minnesota

4th Annual *Fiber Fair Sale*

November 18th & 19th

Friday 11am-9pm

Saturday 10am-5pm

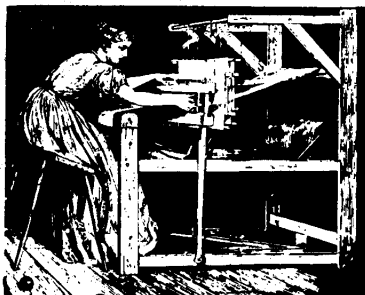

427 1/2 Cedar Ave
Mpls. 55454

hundreds of traditional & contemporary woven articles handcrafted by Guild members.

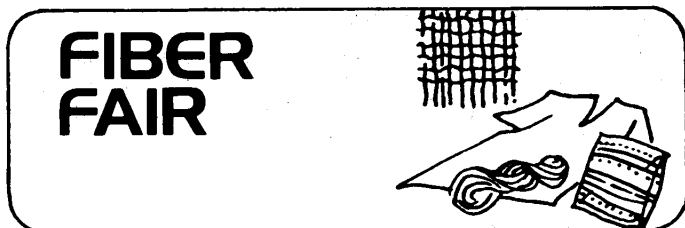

Whether you are fresh from a beginners class or have been weaving for years, we are looking forward to seeing your work at this year's Fiber Fair. This is an excellent opportunity for Guild members to sell their well-crafted, designed and finished fiber pieces.

The entry fee will be \$3.00 and the Guild will receive 15% of all sales. The entry fee will be used for publicity, printing tags, receipt books, and other miscellaneous expenses. The 15% will go towards the Guild'd Building Fund.

Entry blanks are included in this issue. Upon receipt of the entry blank, each entrant will receive a page of guideline, an entry form and Guild tags. If more tags are needed, they can be picked up at the Guild office.

The deadline for entries is October 31. All entrants will be required to work on the Fair in some way. We need your help to make this fair possible.

All new entrants and anyone with questions about their pieces (finishing, hanging, etc.) must show their items to the Selection Committee on October 27 or 28. All entries will be subject to review at check-in.

Fiber Fair dates to remember:

October 27 (Thursday) 7:00 to 9:00 p.m.

October 28 (Friday) 1:00 to 3:00 p.m.

Selection Committee review of new entrants and anyone with a question concerning their entry.

November 16 (Wednesday) 11:00 a.m. to 8:00 p.m.

Check-in for all items sold at the Fiber Fair.

November 17 (Thursday) 9:00 a.m. to 4:00 p.m.

Staging—arranging of items to be displayed.

November 17 (Thursday) 7:00 to 9:00 p.m.

Pre-Sale for all Guild members, providing them with an opportunity to view and purchase the fiber work.

November 18 (Friday) 11:00 a.m. to 9:00 p.m.

Public Sale

November 19 (Saturday) 10:00 a.m. to 5:00 p.m.

Public Sale

November 19 (Saturday) 5:00 to 6:30 p.m. Checkout

(Pick up and check out of all items not sold.)

6:30 to 8:00 p.m. Cleanup.

The Fiber Fair Committee

Kathy Martin

Pat Boutin Wald

Linda Bouchard

Irene Meyers

Sarah Weld

It's easy to learn 4-harness weaving on the Schacht 25" maple tableloom.

Floor stand available.

also, boat, rag and rug shuttles, reed hooks and tapestry beaters.

Threadbenders

- In the Galleria 927-8221
3515 W. 69th St., Edina
- In St. Anthony Park 647-0677
2260 Como Ave., St. Paul

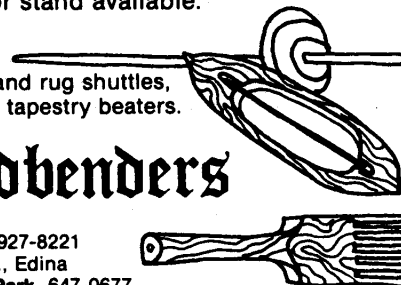

House of Macrame

- cord
- weaving
- jute
- yarns
- beads

Register for fall classes now!

5416 Penn Ave. So.
927-8307

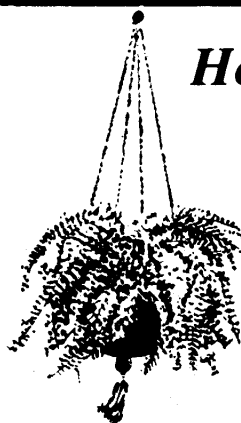

p.s. A WORD FROM THE SELECTION COMMITTEE

The articles to be sold at the Fiber Fair will have to meet the selection committee guideline sent to each participant. Make sure you receive and read a copy of these guidelines. All pieces will be viewed by the selection committee during check in on November 16. If you feel that an article you will be selling should vary from the guidelines, for example you do not wish to pre-wash an article, please bring it, or have a friend bring it, to the early meetings of the selection committee. These meetings for new Fiber Fair participants and for those who have questions about meeting guidelines will be held at the Guild on October 27, 7:00-9:00 p.m., and October 28, 1:00-3:00 p.m. If it is impossible for someone to attend, as a last resort, call Pat Boutin Wald at 331-8202. Please note: there will not be any time for you to make repairs on items if they are brought in late on November 16, and no items will be accepted for sale before 11:00 a.m. or after 8:00 p.m. on that date, so if there are any questions, please clear them up right away.

One change has been made this year. Sturdy labels for weaver's name, washing instructions, etc., must be supplied by the weaver. The Guild tag is for pricing and identification number only. Also, in answer to queries, pillows can be backed with commercial cloth as long as it relates well to the front of the pillow.

There will be a meeting of all selection board members on October 21 at the Guild to discuss guidelines for the Fiber Fair. Anyone who wishes to come and hear or join the discussion—especially anyone who has questions or complaints about items in or not in the guidelines—or anyone who just enjoys a rowdy discussion is welcome.

One last request: anyone who has racks, dress forms or hanging devices that they would be willing to lend the Guild for use at the Fiber Fair, please call Linda Bouchard at 823-4101. Thank you.

Pat Boutin Wald



FIBER FAIR ENTRY FORM

Name _____ Address _____

City _____ State _____ Zip Code _____ Phone _____

All participants will be required to work on one of the following committees or for a 3-hour shift during the fair. Please check one. If for some reason you cannot work one of these into your schedule, please check "other." We have many small tasks that you can help with.

Committees: Publicity _____ Finance _____ Personnel _____ Staging _____ Selection _____ Other _____
Sale work days: Friday, November 18 _____ Saturday, November 19 _____

Enclosed is my entry fee of \$3.00 Make checks payable to the Weavers Guild of Minnesota.

Non-members may enclose a separate check for \$15.00 Guild membership. Members — please check to see if your membership is current.

Complete the above form and mail to: The Weavers Guild
427½ Cedar Avenue
Mpls, MN 55454

DEADLINE IS OCTOBER 31, 1977.



**THE MINNESOTA
WEAVER**

Published monthly except July, August, and December
by the
Weavers Guild of Minnesota

DATES TO REMEMBER

- Thursday, October 6, 9:00 a.m.** Working Bee for MIA Christmas Tree ornaments.
- Thursday, October 6, 1:00 p.m.** October Meeting, reports on conferences attended by members.
- Monday, October 10.** Minnesota Weaver deadline for November issue.
- Thursday, October 13, 9:00 a.m.** Board Meeting. All members welcome.
- Thursday, October 20, 12:00–3:00 p.m.** Working Bee for MIA Christmas Tree.
- Thursday, October 27, 7:00–9:00 p.m.** and
- Friday, October 28. 1:00–3:00 p.m.** Selection Committee for new Fiber Fair entrants.
- Wednesday, November 2, 9:00–12:00 and 7:00–9:00** Working Bee for MIA Christmas Tree.
- Thursday, November 3, 1:00 p.m.** November Program, Grete Heikes, "Primitive Studies."

For details see "COMING UP" on page 1.

The Weavers Guild of Minnesota
427½ Cedar Avenue
Minneapolis, Minnesota 55454
332-7521

NON PROFIT ORG.
U.S. POSTAGE
PAID
PERMIT NO. 2963
MPLS., MINN.

