

LOOM
MUSIC

VOLUME II

NUMBER 1

JANUARY, 1945

Mary Sandin
Edmonton

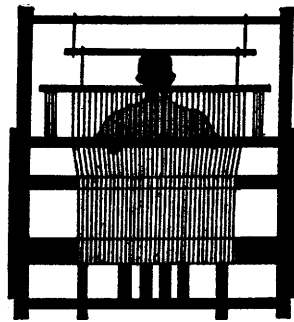

Ethel Henderson
Winnipeg

GLASS CURTAINS IN "SWEDISH LACE"

We greet you with the heartiest of good wishes for 1945, and express the hope that you will be expanding your weaving knowledge, with the help of our, and other publications, as time goes on.

Our weaving seems doubly valuable in the light of present-day conditions in the manufacturing and textile industries -- A friend observed, "I wish you could weave hosiery!" Our aim this year is to include directions for several household articles, designed for allure and practicability.

This month we give you "Glass Curtains". The type of curtain we have in mind is not too closely woven, yet closely enough to preserve the weave after laundering. For this there are two types of weave often used: "Leno" and the "Swedish Lace" weave. This latter is not to be confused with the "Bronson" or "Spot" Weave, which is sometimes referred to as "Swedish Lace". In the Bronson weave all the warp skips are on one side of the fabric, and all the weft skips on the reverse side. One of the "Swedish Lace" drafts given here produces the warp skips and weft skips alternating on the same side of the fabric, while the other draft produces warp skips on one side, weft skips on the reverse side. The drafts for the Bronson and the Swedish Lace weaves are entirely dissimilar.

We have chosen this Swedish Lace in preference to

Tie-Up

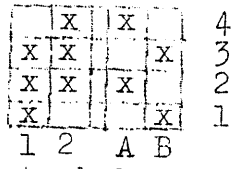

Counterbalanced Loom

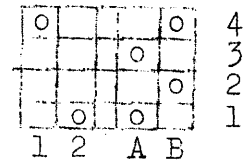

Rising Shed Loom

THE THREADING

Selvage for side hem, 2" wide x 4,1,4,1 = 30 ends
 17 repeats of A and B alternately (34 ends) = 578 ends
 1 repeat of A, to balance = 17 ends
 Selvage for side hem, 2" wide x 1,4,1,4 = 30 ends
655 ends

THE TREADLING

Weave tabby, alternate treadles A and B, for the desired width of hem and heading, ending with treadle B. Then for the lace squares:

First row of squares

- 1. Treadle 2 once
- B "
- 2 "
- B "
- 2 "
- B "
- A "
- B "

repeat this unit 3 times, omitting the last tabby B after the third repeat.

Second row of squares - the alternate squares

- 2. Treadle 1 once
- A "
- 1 "
- A "
- 1 "
- A "
- B "
- A "

repeat this unit 3 times, omitting the last tabby A after the third repeat.

Third row of squares

- 3. Repeat (1) above

Continue alternating these units, three times each as noted above, for the length of the curtain.

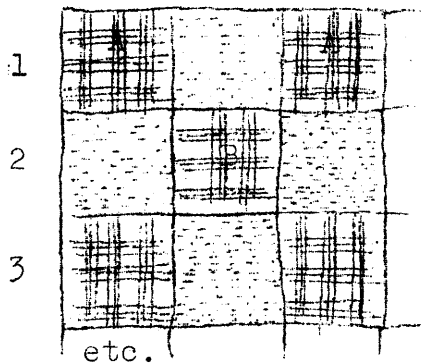

Here again, care must be taken to maintain a light, even beat throughout. The tabby selvage will serve as a guide -- regulate your beat so that there are the same number of weft shots per inch as you have warp ends per inch (50-50).

Variations

It will be seen that by repeating one of the above treading units throughout, vertical stripes will result; or that the squares may be made into oblongs by increasing the number of times each unit is treadled.

Again, if larger squares are desired, the threading draft is easily adjusted to produce them. For example, in the threading draft Lace Square "A" is threaded $\begin{matrix} 4 & 4 & 4 \\ 1 & 3 & 3 \end{matrix}$, three times, with the 1 left out the final time, since if it were left in, two 1's would come together in going on to thread Lace Square "B". So that in order to have larger squares, enlarge the "A" group by repeating this 6-thread group more than three times, always leaving out the final "1". Lace Square "B" would be correspondingly enlarged by repeating its 6-thread group $\begin{matrix} 4 \\ 1 & 2 & 2 & 1 \end{matrix}$, always leaving out the final "4" of the last repeat.

III. Kitchen Curtains

Our third plan is for kitchen type curtains, or "cottage curtains" as they are known -- two curtains for the upper sash and one for the lower sash, the latter very full.

Upper Sash: We plan green inside borders and green bottom hems, with narrow inner bands of peach, turquoise, and yellow, each separated by a quarter-inch band in bright henna. The bands are plain tabby weave separated by the lace weave, while the center is white in all-lace weave. The plan therefore requires color in both warp and weft.

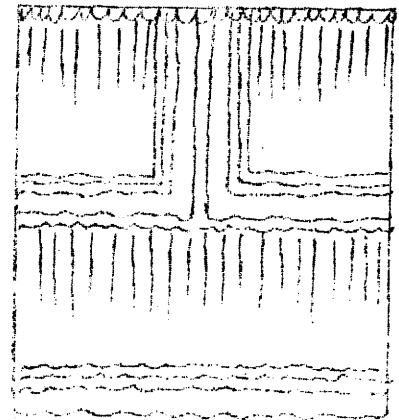

Lower Sash: This curtain is made of one length of the material, woven with an all white weft, so that the colored

bands in the warp constitute the bands at the bottom of the curtain.

WARP MATERIAL: 16/2 cotton in white, peach, turquoise, yellow, green, bright henna.

WEFT MATERIAL: the same as the warp in weight and color.

COLOR RECKONING: (16/2 cotton = 6720 yds. per lb.)

4" green for inside band: 120 ends x 4½ yds. = 540 yds.

Using the same amount for weft: 1080 yds., or approximately ¼ lb.

32 ends bright henna (4, 8-thread stripes) -- ¼ lb. will be plenty;

16 ends peach -- again, ¼ lb. will be plenty;

16 ends turquoise - " "

16 ends yellow -- " "

880 ends white: 880 x 4½ yds. = 3960 yds., plus the same quantity for weft = 7920 yds., or 1¼ lbs.

THE THREADING:

The warp is threaded two ends per dent in a 15-dent reed where the draft reads 1,4,1,4, etc.; 4 ends in one dent with a dent missed on each side, where the draft reads 4,3,3,4, 1,2,2,1. This amounts to 2 ends per dent all the way through, or 30 ends per inch.

Width in reed: 36 inches: 36 x 30 = 1080 warp ends.

Length for one set of curtains: 4½ yds. warp, which includes ¾ yd. loom waste.

Tie-Up

Threading Draft

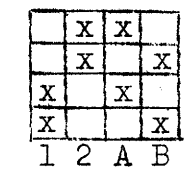

Counterbalanced Loom

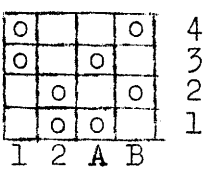

Rising Shed Loom

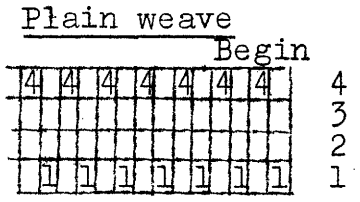
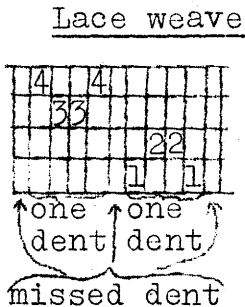

4
3
2
1

When repeating the lace weave portion of the draft, omit the last missed dent after each repeat, as not to do so would give 2 missed dents. The dent is missed when going from lace to plain in the threading.

Threading Details

Green,	1,4,1,4, etc., for	16 ends
Green,	11 repeats of lace weave	88 ends
Green,	1,4,1,4, etc., for	16 ends
Bright henna,	1 repeat of lace weave	8 ends
Peach,	1, 4,1,4, etc., for	16 ends
Bright henna,	1 repeat of lace weave	8 ends
Turquoise,	1,4,1,4, etc., for	16 ends
Bright henna,	1 repeat of lace weave	8 ends
Yellow,	1,4,1,4, etc., for	16 ends
Bright henna,	1 repeat of lace weave	8 ends
White	102 repeats of lace weave	816 ends
White	1,4,1,4, etc., for	64 ends

This white tabby portion will serve as heading for the lower sash curtain. It serves also as the outer hem on the upper sash curtains -- if a narrower hem is desired there, trim after weaving.

THE WEAVING

This is the Swedish Lace which produces warp skips and weft skips alternating on the same side of the fabric.

Top sash curtains - bordered on inner side and bottom.

1. With green 16/2, weave tabbies A and B alternately for $1\frac{1}{4}$ inches, which will provide for a half-inch border with a half-inch hem. End with tabby B.
2. With green 16/2, weave A, 1, A, once, B, 2, B, once. Repeat for 3", or until the corner is square.
3. With green 16/2, weave A and B alternately for one-half inch, or until the corner is squared. End with tabby B.
4. With henna 16/2, weave A, 1, A, once, B, 2, B, once.
5. Repeat #3, using peach 16/2.
6. Repeat #4.
7. Repeat #3, using turquoise 16/2.
8. Repeat #4.
9. Repeat #3, using yellow 16/2.

10. Repeat #4.

11. For the remainder of the desired length of curtain, weave in white 16/2, A, 1, A, and B, 2, B, alternately.

12. With white, weave A and B alternately to provide for the hem or heading desired at top of curtains.

REPEAT 1 to 12 above, for the curtain's pair.

Lower Sash Curtain: Weave the desired length (for width of window), using white 16/2 throughout, treadling A, 1, A, once, B, 2, B, once, and repeat, for the body of the curtain. For side hems, begin and end the lower curtain with a band of tabby: treadles A and B used alternately.

Colored bands along side will weave in tabby to match upper sash curtains.

We are glad to pass on the word that the Searle Grain Co., Grain Exchange Bldg., Winnipeg, is now ready to supply to Canadian weavers price lists pertaining to their stock of cotton and linen threads, also yarns.

Canadian weavers can now purchase the very excellent cottons manufactured by Lily Mills, from Lewis Craft Supplies, Ltd., 8 Bathurst Street, Toronto, Ontario. They carry a wide variety of cottons of all types and sizes, in a wide range of colors.

We had prepared a short list of some of our favorite weaving books, to include with this issue. Lack of space is going to make it necessary to wait for a later issue to give you the list.

We cannot close this bulletin without a comment on the

heartening letters we have been receiving from subscribers in various localities. While we have a faint suspicion that they do build up our ego, they make us feel very humble, too. We cannot but think how privileged we are to be able to give the encouragement which you say we have given. It is our earnest hope that our future work will continue to be satisfying, and that all of us together will go forward along the path of accomplishment.

Good Weaving!

Ethel Henderson *Mary Sandin*
 Mrs. E. M. Henderson
 20 Ritz Apartments
 Winnipeg, Manitoba

Mrs. R. B. Sandin
 University of Alberta
 Edmonton, Alberta

Per year \$3.00
 single copy .35
 Copyright 1945

LOOM
MUSIC

VOLUME II

NUMBER 2

FEBRUARY, 1945

*Mary
Sandin*
Edmonton

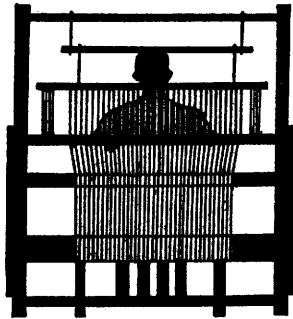

*Ethel
Henderson*
Winnipeg

L O O M M U S I C

Volume II, No. 2

February, 1945

BEDSPREAD AND ACCESSORIES IN "CHENILLE"

In the latest Beriau book, "Tissage Domestique", a rather interesting development, based on a simple draft, has been made. It is so satisfactory for some uses that we are bringing it particularly to your attention.

We refer to the page titled "Chenille" (p.316-17). The technique shown enables us to achieve good effects with a surprisingly small effort. The process is thus: The warp is set up to weave tabby and the one needed pattern shot. For the warp and also for the tabby weave, 8/2 cotton is used. For the pattern shot, a heavy cotton such as a 12/4 cotton, candlewick cotton, or Lily Mills 6-strand filler (Art. 914) is used. This heavy pattern shot is woven in the areas where chenille is desired, resulting in the following:  , consisting of long skips of the heavy cotton on a firm tabby background. One then cuts up the centre of the skips with sharp scissors, on the lines indicated by the arrows above. The cotton is fluffed up with the hand and steamed. Result, - a thick, heavy, velvety pile, hardly recognizable as cotton. The chenille is striped in appearance, but very pleasingly so.

We did some experimenting and found that the pattern areas could be laid-in in isolated groups or as borders, as well as in stripes all the way across the material:

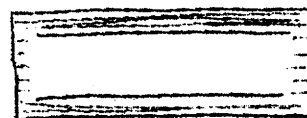
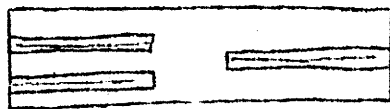

We saw the drapes illustrated on page 321 of "Tissage Domestique", displayed in the salesroom of the Searle Grain Company, and they immediately stirred us with ambition. The cost, we were told, was less than \$10 for the pair. For rooms in the "modern" decor, or for bedrooms, it is one of the most effective treatments we have yet seen in hand weaving. For those who have not this volume of Beriau, we explain that these drapes were done in horizontal chenille bands of varying widths against the tabby background.

Our minds suggested the possible objection, of course, that the heavy cotton was not knotted in, but was held only by the tabby shots and grouped warp ends. However, after examining several commercial "chenille" articles, we found no difference, and as these do launder, we felt safer in passing the process on to you.

We visualize a use of the technique for bedroom rugs, on a heavy carpet warp foundation, with an all-over laid in pattern of heavy rug wool in various colors. Then, for the bedroom furniture, there would be a choice of runners and doilies with borders of chenille, dressing table seats, or a bed spread with borders and bands for trimming. A one-inch band would be effective on lamp shades. The process lends itself to ingeniousness (only, of course, like any pattern or technique, you won't "overdo" the amount used in any one room).

We are giving you directions for tailored bedspreads for twin beds, and doilies for the bedroom furniture.

CHENILLE BEDSPREAD

For color, we make no suggestions, since your own color scheme will determine that. However, pastels are indicated: green, turquoise, beige, blue, etc., or white or natural. Chenille areas may contrast in color, or may be

white or natural on a colored background.

Our plan is for a spread for a single bed, 39" in width, with the "skirt" hanging to within one inch of the floor. For the pair the warp is doubled in length. There will be a seam at A and B, hidden under the chenille band, but the weaving of all the strips is done in one length, on the one threading.

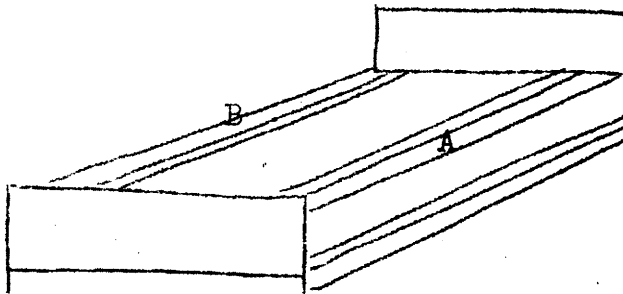

Plan: Centre piece 27" wide finished, 30" wide in the reed, 104" long. Side pieces 27" wide finished (30" wide in the reed), which provides for 6" on top of the bed, an 18" overhang, and a generous hem. For two sides, 104" x 2 = 208" long.

Total length for one spread = 312" or $9\frac{1}{2}$ yards of warp, including allowance for loom waste. Total length for two spreads, $18\frac{1}{2}$ yards of warp.

Nine and one-half yards of 8/2 at 3360 yds. per pound, set at 30 ends per inch, 30 inches wide = approximately $2\frac{1}{2}$ lbs. of warp. Tabby for weft requires approximately the same amount, so that 5 pounds of 8/2 is required for each spread.

The heavy pattern weft will require about $1\frac{1}{2}$ pounds for each spread. More will be needed if wider chenille bands are desired.

four pattern spaces. Still using pedal 1, with the second flat shuttle and its pattern weft, come from the left edge toward the centre for four pattern spaces. Throw tabby 5.

3. Using pedal 1, throw pattern wefts back to their respective outside edges, making neat turns. Tabby 6.

Repeat 1, 2, 3, as above, until 102 inches are woven.

Weave a 1" tabby heading for hem turn-in.

: Duplicate the above centre strip for the second spread.

Side pieces:

1. Weave a 1" tabby heading, ending on tabby 6.

2. Using pedal 1: on the right hand side, about 6" from the edge, begin to pick up as many patterns as are desired for a border along the outside edge of the spread. Throw tabby 5. The left hand side is all tabby, and is to be sewn to the centre pieces.

3. Using pedal 1, throw pattern weft back to the right edge, making a neat turn. Tabby 6.

Continue for 102 inches, and end with a 1" tabby heading.

Weave three more identical side pieces to complete the set.

Seam the side pieces to the centre piece by overcasting closely. Finish by the cutting and steaming process mentioned on page 10. The steaming should shrink the article and makes immediate washing unnecessary.

CHENILLE DOILEY OR RUNNER

We will plan for one small piece only, since the measurements will vary to meet your own needs. Ours will be a doiley 12 x 15 inches in size.

Use the same 8/2's warp, 8/2's tabby, and heavy pattern

weft as for the spread, the warp set 13" wide in the reed, with a threading plan as follows:

Selvage, 1,2,3,4	4 ends
Second part of draft: 3,2,3,4 in one dent,	
once	4 ends
First and second parts of draft, for 18	
complete repeats, 18 x 24 ends =	432 ends
Second selvage, 3,2,1	3 ends
	<u>443 ends</u>

The Weaving

Weave one-half inch tabby for hem turn-under, ending on pedal 6.

Using pedal 1, weave all the way across with pattern weft. Throw tabby 5.

Using pedal 1, weave back with pattern weft. Throw tabby 6.

Repeat for $1\frac{1}{2}$ " of pattern.

With two pattern shuttles, following the technique on page 13 for the centre piece of the spread, weave a chenille band on each edge, for a width of two patterns, following each pattern shot with its proper alternate tabby shot. Continue for 13" of weaving.

Weave $1\frac{1}{2}$ " of pattern rows as at the beginning, ending with a half-inch tabby turn-under.

Hem, cut, and steam.

Try the above doiley first as a sample, -- it's effective and it's fun.

A FEW BOOK REFERENCES

For some time we have been anxious to give you a short list of useful books published on the subject of weaving, where they may be obtained, and their approximate price from the publisher. We have had many inquiries about the books by Oscar

Beriau, ever since we mentioned them first in our March, 1944 issue

1. HOME WEAVING, Oscar Beriau,
The Institute of Industrial Arts,
Gardenvale, Quebec, 1939 (in English) \$3.00
2. LE METIER A QUATRE LAMES, Oscar Beriau,
Minister of Agriculture,
Quebec, P.Q., 1941 (in French) 1.00
3. TISSAGE DOMESTIQUE, Oscar Beriau
Minister of Agriculture, 2.00
Quebec, P.Q., 1943 (in French)

These three books contain some of the best colored illustrations, with instructions, to be found anywhere. While No. 3 is more or less a combination of Nos. 1 and 2, they are all interesting. If only one can be purchased, No. 3 is recommended. No more varied use of simple drafts, particularly twills, can be found in one volume. A must for your library.

4. VAVBOK I & II, Sigrid Palmgren,
Albert Bonnier Publishing House,
665 Lexington Ave., New York
(in Swedish) about 3.50

An interesting book, without notes, very well illustrated in color -- for those familiar with Scandinavian techniques.

5. THE SHUTTLE-CRAFT BOOK OF AMERICAN HAND-WEAVING,
Mary M. Atwater,
The Macmillan Co., New York, Toronto 3.50

This is a standard text and reference book, containing notes and drafts on standard weaves. It should be on every weaver's book shelf.

6. AMERICAN AND EUROPEAN HAND WEAVING REVISED,
Helen Louise Allen,
Brown's Book Store, Madison, Wisconsin 2.00

Miss Allen describes and lists practically all of our weaving techniques, constituting an excellent dictionary of weaves. It is well illustrated, and a reference book we cannot afford to be without.

7. A HANDWEAVER'S PATTERN BOOK,
Marguerite P. Davison,
Swarthmore, Pa., Box 299 6.50

Mrs. Davison gives a collection of 4-harness drafts and variations on them, with black and white illustrations. Extremely useful to

the weaver who can arrange her own drafts.

8. FOOT-POWER LOOM WEAVING, Edward F. Worst,
Bruce Publishing Co., Milwaukee, Wis. \$6.50

In addition to being a standard reference book, it contains excellent material on Scandinavian methods, with a number of Scandinavian drafts.

9. THE WEAVER, published quarterly from 1936 to 1942, by E. Bernat & Sons Co., Jamaica Plain, Mass. per year 1.00

The issues are very well illustrated, with articles by various weavers throughout the country. A number of back copies are available.

10. HAND LOOM WEAVING FOR AMATEURS, Kate Van Cleve, The Beacon Press, Inc., Boston, Mass. 1.00

While this book is devoted largely to two-harness and other simple types of weaving, it has special value in its well-illustrated notes on the warping and threading processes, and simple edge finishes.

11. WEAVING AT THE LITTLE LOOMHOUSE, Lou Tate, 1725 Third St., Louisville, Ky. 1.00

Its text and illustrations are an inspiration to any weaver.

This list is by no means a tithe of the books available on the subject. What we did was to take a glance over our own book shelves to pick out the ones we'd never consent to part with. Later, we'll give a list of books on textiles and books on weaving, without drafts included.

Good Weaving!

Mary Sandin

Mrs. R. B. Sandin
c/o University of Alberta
Edmonton, Alberta

Ethel Henderson

Mrs. E. M. Henderson
20 Ritz Apartments
Winnipeg, Manitoba

Per year \$3.00
Per copy .35
Copyright 1945

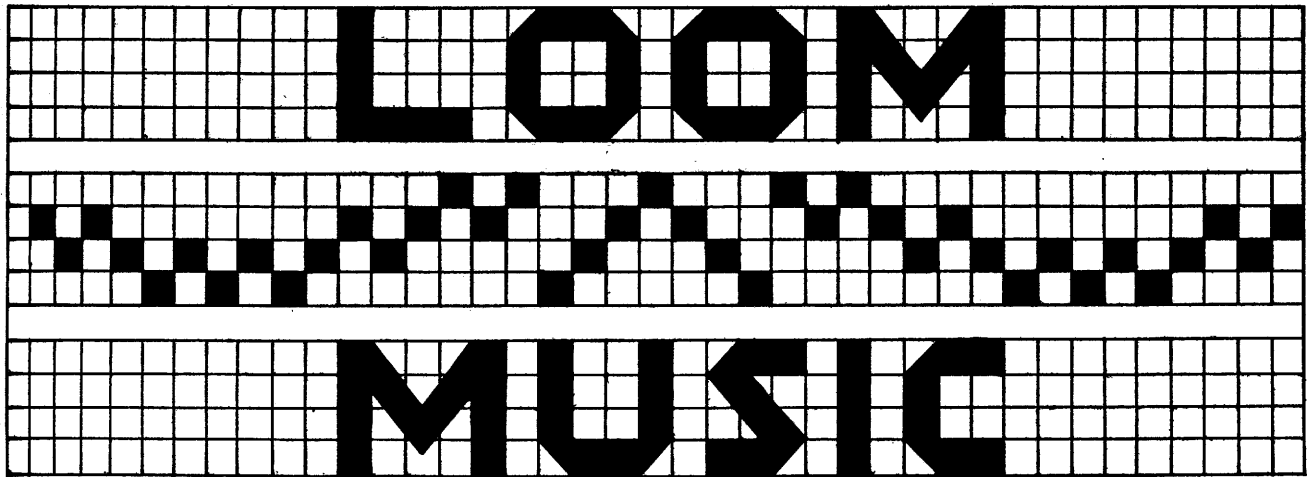

VOLUME II

NUMBER 3

MARCH, 1945

Mary
Sandin
Edmonton

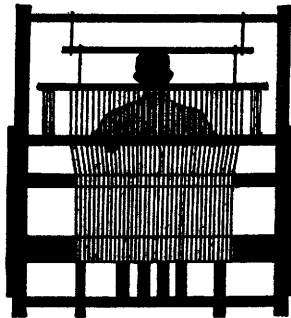

Ethel
Henderson
Winnipeg

L O O M M U S I C

Volume II, No. 3

March, 1945

BABY BLANKET IN "DOUBLE WEAVE"

Many weavers have the desire to try techniques new to them, and we think this is excellent. It is always a satisfaction to try an unfamiliar technique, to conquer it, and to make it one's own. Let us then, attempt, and accomplish, "Double Weave" adapted to a baby blanket. These blankets seem to be a real necessity, and a recent need for one pointed up sharply their present scarcity on the market.

Four-harness "Double Weave" is recognized by the following:

1. It is composed of two separate tabby fabrics, one superimposed upon the other.
2. The top layer and the bottom layer are generally of different color.
3. A motif or pattern is usually laid in, the motif appearing on each side in the reverse color, and interwoven at the points of outline.

In weaving, particular attention must be paid to the "take-up" of the weft. Unless a deep arc of weft is left in the shed, the edges draw in. How much or how little to leave is determined at the loom.

Draft and Tie-up for "Double Weave"

			X		X
		X			X
	X			X	
X				X	
1	2	3	4	5	6

Tie-up for Sinking Shed Loom

			o		o
		o			o
	o				o
o					o
1	2	3	4	5	6

Tie-up for Rising Shed Loom

						Begin
W		W		W		4
	W		W		W	3
		b		b		2
			b		b	1

Draft

In this direct tie-up, harness 1 is tied to pedal 1, harness 2 to pedal 2, harness 3 to pedal 3, and harness 4 to pedal 4. Combinations are made by the use of two or three pedals together, as needed.

THE WARP

Three blankets are none too many, set 36" wide and woven 45" long on the loom, of 3-ply yarn in white and in blue.

Warp setting: 30 ends per inch: 1 end per heddle, 2 ends per dent in a 15-dent reed. As weaving progresses, this works out to 15 ends per inch for each layer.

Estimate of material: 36" wide x 30 ends per inch = 1080 warp ends. 3-3/4 yds. long plus 3/4 yd. loom waste = 4 1/2 yds. of warp. 4 1/2 yds. x 1080 ends = 3780 yds. of wool, or approximately 1-3/4 lbs., - half of it white and half blue. Weft allowance: same amount as for warp, again, half of it white and half blue.

Warping details: The warp is wound in the two colors, - 2 ends blue, 2 ends white, 2 ends blue, etc. This is so that the warp can be threaded in accordance with the draft above: 1, 2, blue; 3, 4, white, etc.

THE WEAVING

First, let us explain the process. Our warp is treated as two tabby weavings: (a) upper, (b) lower. These two layers are interchangeable at will, controlled by the harness combinations used. One quickly grasps these combinations, since, on a sinking shed or counterbalanced loom:

treadle 6	raises the blue warp ends (harnesses 3 & 4)	
treadle 5	raises the white warp ends	" 1 & 2)
treadles 1 and 6	raise half the blue warp ends	" 1,3,4
treadles 2 and 6	raise the other half of the blue	2,3,4
treadles 4 and 5	raise half the white warp ends	1,2,4
treadles 3 and 5	raise the opposite half of the white	1,2,3

Practice these first, without weaving, to become familiar with the way in which these treadlings affect the warp threads.

Four passes of the weft comprise one set of treadlings, 2 for the white surface and 2 for the blue surface. We give below the blanket directions, the white surface to be on top during the weaving of the main portion of the blanket. All the treadlings given refer to the tie-up for the sinking shed loom, and should be adjusted if a rising shed loom is used.

Set I { Pass 1: treadles 4 and 5, weave with white shuttle
 Pass 2: treadles 3 and 5, weave with white
 Pass 3: treadle 1, weave with blue
 Pass 4: treadle 2, weave with blue

Repeat the four passes of Set I for two inches of weaving, then weave a 1" band of blue by following the passes of Set II:

Set II { Pass 1: treadles 2 and 6, weave with blue shuttle
 Pass 2: treadles 1 and 6, weave with blue
 Pass 3: treadle 3, weave with white
 Pass 4: treadle 4, weave with white

How are the edges? Be sure they are not drawing in!

How is the beat? The blanket, after it is off the loom and steamed and pressed, should consist of two layers of 50-50 tabby fabric; i.e., the same number of weft shots per inch as there are warp ends per inch.

Continue weaving the blanket in the following order:

Set I for 1 inch, white on top
 Set II for 1 inch, blue on top
 Set I for 1 inch, white on top
 Set II for 1 inch, blue on top
 Set I for $2\frac{3}{2}$ inches, white on top
 Set II for 1 inch, blue on top (motif border)
 Set I for $1\frac{1}{2}$ inches, white on top.

The sketch shows the plan of the stripes and the motif areas, -- the directions for weaving start from the bottom of the blanket.

By the time this amount of weaving has been done, the process will, we are sure, be automatic, and you are prepared for the technique of weaving the motif. This is a simple pick-up process.

This type of 4-harness double weaving with a motif is known in Scandinavian books as the "Finnweave", but their process of picking up and weaving is a rather complicated one. The Mexican weavers use a simplified process. At one point in the Mexican process, which we shall hereafter note, their pick-up is not as neat as the Finnweave, hence the method we give embraces both techniques. Mrs. Atwater advises the use of this combined method.

The motif must be planned and worked out on squared paper, and for this baby blanket we have selected a rocking horse, balanced by a building block on each side, with the child's initials in the blocks. When the "pick-up" is finished, the motif will be in blue on the white background on the top side of the blanket, and vice-versa on the under side.

Our graph gives two warp ends corresponding to one square, and refers only to all white ends, or all blue ends, at one time. There are 27 pairs of warp ends for each side border, 16 pairs of warp ends for the initial blocks on each side, 20 pairs of warp ends on each side between the initial blocks and the widest point of the motif at the rocker, 56 pairs of warp ends for each horse motif, leaving 32 pairs of warp ends for a centre between the two horses.

Since space permits us to give details of only one-half

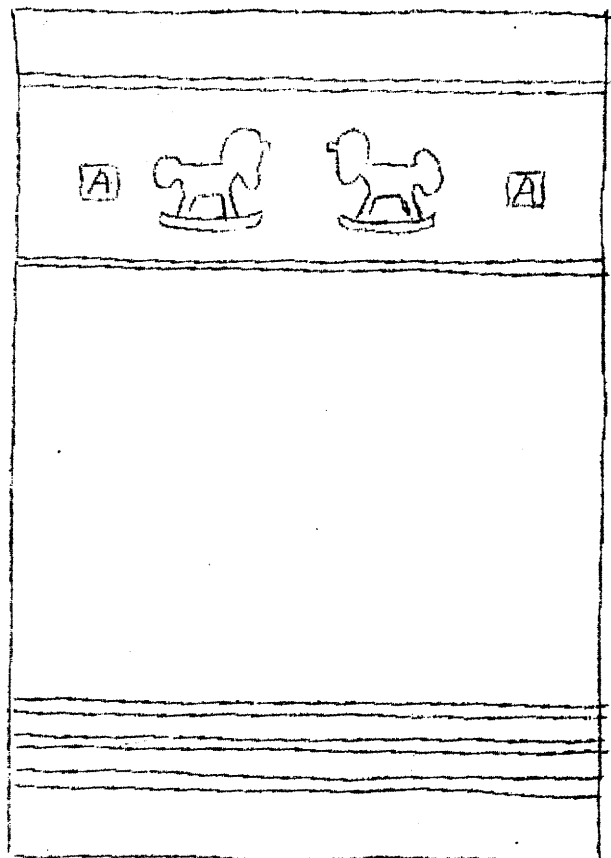

MOTIF FOR BABY BLANKET IN "DOUBLE WEAVE"

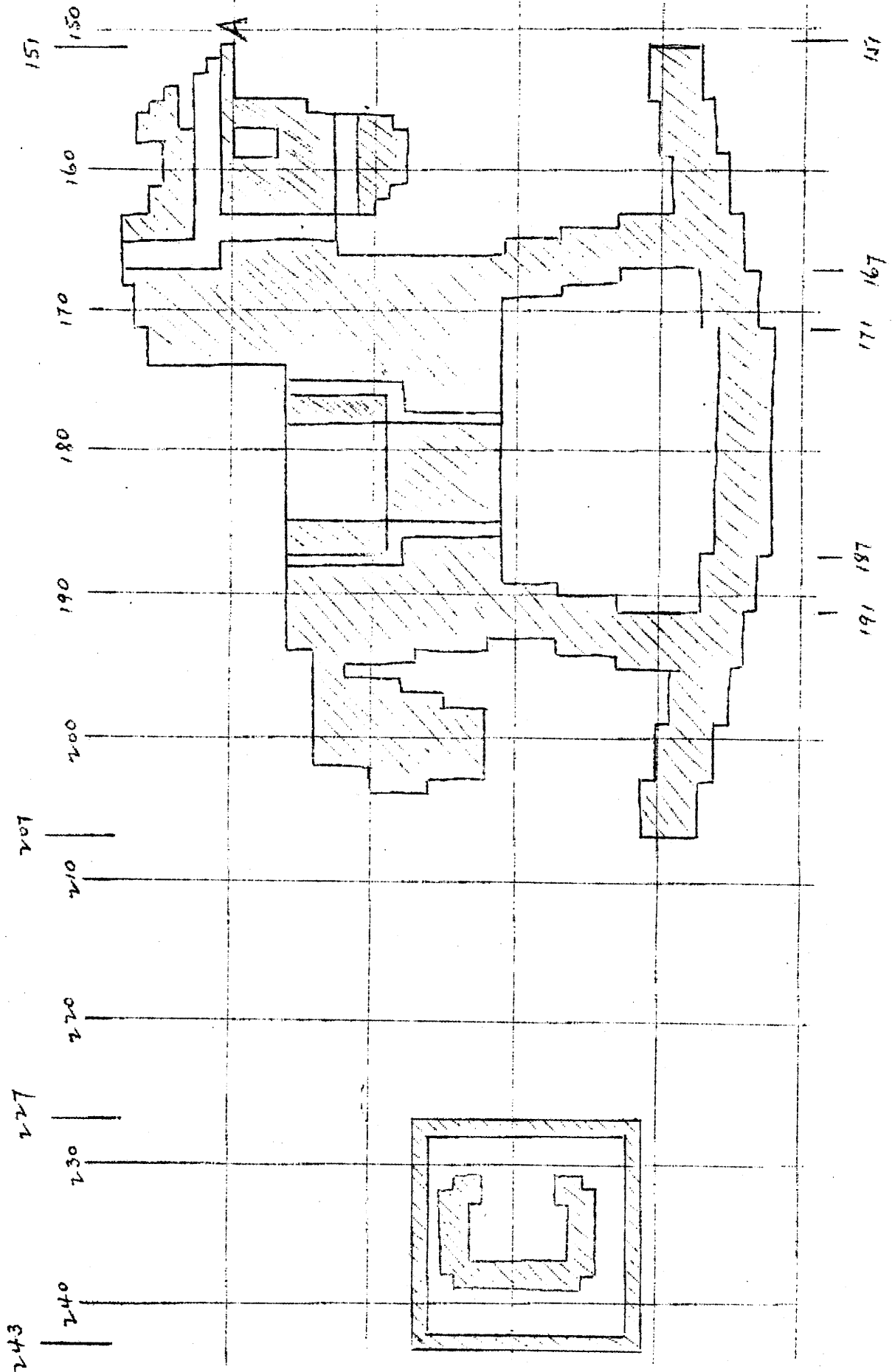

ALPHABET FOR BABY BLANKET IN "DOUBLE WEAVE"

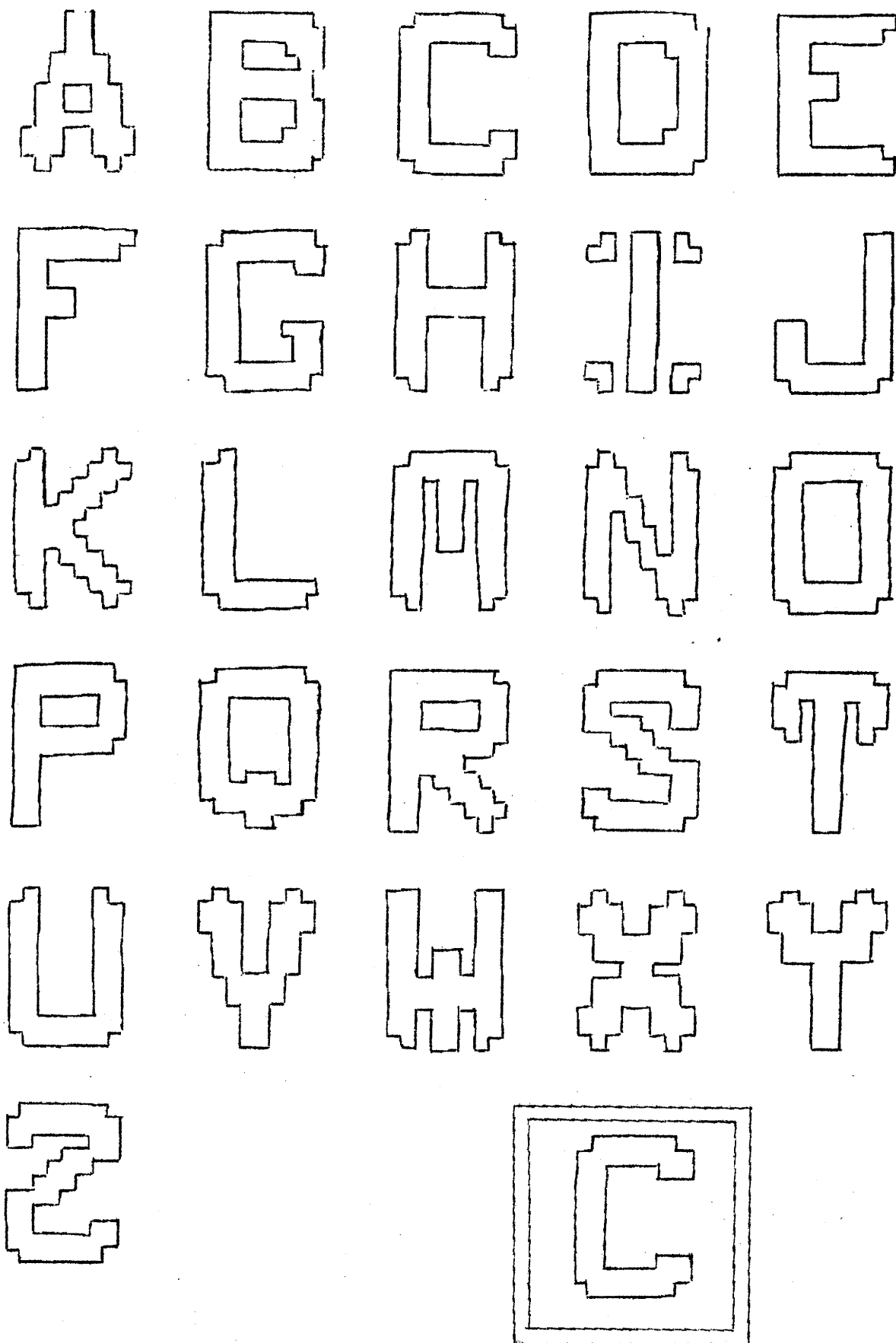

of the motif, the weaver should draw out the complete design band for her own use at the loom. For this, use a piece of graph paper (the kind which is ruled 10 squares per inch) 27 inches long by about 6 inches wide. You will probably need to paste sheets together to get the necessary length.

At the top of the paper, number the squares across the page by 10's, beginning at the right hand edge: 10, 20, 30, etc.

To lay out the design, from our page 22: at the top of your page mark also squares numbers 27, 43, 63, 119, 151, 207, 227, and 243. These squares mark the edge boundaries of the four design areas. Then draw the left-hand horse on your paper: on square 151, count down 10 squares, which will correspond to point "A" on the horse's head. From this starting point, draw the left horse to scale on your paper. From a similar starting point down on square 119, draw the right-hand horse, so that the two horses face each other (on squares 63 to 119 inclusive).

Lay out the frames which enclose the initials, between blocks 27 and 43, and between 227 and 243, each square starting 14 squares up from the base of the rocker. Insert the appropriate initial inside the frame, giving it a 3-square border at each side, 1 square at the top, and 2 at the bottom.

THE PICK-UP

We start with the bottom of the rocker on the graph, which is square 83, on the right-hand rocker.

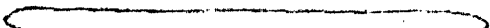
1. Since the figure is in blue on a white ground, raise all the blue warp ends (treadle 6). Have ready a thin stick $1\frac{1}{2}$ " wide and 40" long, brought to a smooth, flattened, rounded point at each end: 

2. With the beater at the rest position (away from you), slide the point of the pick-up stick from the right of the raised blue warp, as follows:

over	blue	pairs	1	to	83
under	"	"	84	to	99
over	"	"	100	to	171
under	"	"	172	to	187
over	"	"	188	to	270, which brings the pick-

up stick to the left side of the warp.

Slide the stick, with its picked-up threads, back against the reed, letting it ride the top of the shed.

3. Raise one-half of the white warp (treadles 3 and 5) and weave white. It may not beat back because of the stick, but it will with the next pass.

4. Raise the other half of the white warp (treadles 4 and 5) and weave white. Take out the pick-up stick and beat neatly. Use special care to get a good edge.

5. Raise all the white warp (treadle 5). With the stick pick up the background squares of the graph, again working from right to left, omitting the first and last white thread in each space between the groups of blue design threads. This splitting of pairs adjoining the dark threads is the Scandinavian technique and makes the join neat and the fabric exactly reversible.

Push the stick back against the reed and let it ride the shed.

6. Using treadles 2 and 6, weave blue, beating as well as possible with the stick in position.

7. Using treadles 1 and 6, weave blue. Remove pick-up stick and beat blue into position.

This completes one set of pick-up. The sheds will be rather shallow, but the wefts may be carried on a flat shuttle to make weaving easier.

The next point to consider is whether this amount of treadling -- two shots on each surface -- makes a square with the two warp ends used for each square in the plan. If it does, one set of pick-up is sufficient for each vertical square on the plan;

if it doesn't square, two sets of pick-up will be required to keep the proportions of the figures.

To pick up the next row of squares in the rocker:

Treadle 6, and working from right to left with the pick-up stick, go

over	blue	pairs	1 to 79
under	"	"	80 to 103
over	"	"	104 to 167
under	"	"	168 to 191
over	"	"	192 to 270

With the stick back against the reed, treadles 3 and 5 and weave white, treadles 4 and 5 and weave white.

Treadle 5 and pick up white background, again omitting the first and last white threads in each square between the groups of blue design threads.

With stick back against the reed, treadles 2 and 6 and weave blue, treadles 1 and 6 and weave blue.

To summarize the pick-up process:

Treadle 6	and pick up pattern areas,
treadles 3 and 5	and weave white
treadles 4 and 5	and weave white
Treadle 5	and pick up background areas,
	splitting the pairs to each side
	of the design areas
treadles 2 and 6	and weave dark
treadles 1 and 6	and weave dark.

Continue these sets of pick-up as directed above, changing the positions of the motif and background in accordance with the graph.

When the design band is completed, return to Set I treadlings of the first part of the blanket, weaving white on top, for 1 inch of weaving.

Set II, weave blue on top for 1 inch
Set I, weave white on top for 4 or 5 inches, to complete the blanket length of 45" on the loom.

FINISHING - Machine stitch the blankets at each end, with two

stitchings 1/4" apart, and cut between the stitchings. Shrink by steaming and pressing. Bind with satin ribbon, mitering the corners of the ribbon and using invisible hemming stitches.

We do hope our weavers will try this technique, if only to do a sample. Also, we would encourage the designing of one's own motifs. Family backgrounds, favorite animals, sampler figures, legendary local figures, etc., -- anything that will work out in silhouette is effective. A sampler might be done in contrasting colors of carpet warp: navy or black and white, henna and cream, etc. The carpet warp is set also at 30 ends per inch.

For motif, we recall an effective design worked out in navy and white, by Miss Dorothy Macdonald of Toronto, -- Noah and Mrs. Noah on each side of the Ark, surrounded by pairs of animals, framed all around by a border. This was so entertaining that a companion piece was designed, -- "Eve" under the "Tree of Knowledge", with the Serpent framing the whole.

This seems a good place to quote from a letter from Miss Macdonald: "Weavers, (beginners) are scared of using their own judgement about colors and materials, and they don't seem to understand that the only way they will ever get any confidence in themselves is to study every bit of work they can get their hands on; and then go and experiment for themselves. So many people seem to be hypnotized by the idea that they cannot draw, and therefore cannot design. If they could only think that designing for textiles first means an understanding of the technique they are using, and then means a choice of materials, colors and proportions, I think there might be some exciting results."

Let's see some of your designs, for our files, won't you?

Good Weaving!

Ethel Henderson *Mary Sandin*

LOOM
MUSIC

VOLUME II

NUMBER 4

APRIL, 1945

Mary Sandin
Edmonton

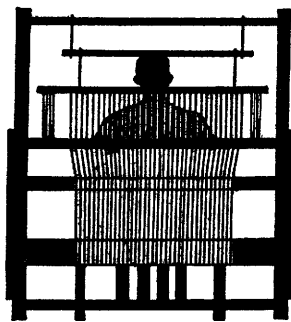

Ethel Henderson
Winnipeg

4-HARNESS OVERSHOT WEAVE

All over our continent, groups of weavers meet to exchange ideas and enjoy each other's accomplishments. We have heard of many such groups, calling themselves by a variety of names. It is the dream of your authors that, in the not too distant future, there will be an affiliation of these groups to make a friendly whole, promoting the best interests of our craft. Do you, too, dream?

In each of our small groups, we find weavers of every inclination: those who weave for relaxation, the weavers who find at the loom the satisfaction of their creative urge, the weavers who supplement their income with their labors, and the weavers who enjoy the technical problems of drafting. Despite these differences, we are sure that weavers everywhere are unanimous on one point, -- a strong desire to improve our working knowledge, "Pacing each other on the road to excellence," not competing one against another.

This month we are discussing some technical points dealing with the 4-harness overshot weave. In our file is a list of some of the goals we must attain for a well-rounded background knowledge of this section of the weaves. We hope the list will not discourage new weavers, but that it will serve as a guide to them for future study. For experienced craftswomen or craftsmen it may be a "refresher" and afford them satisfaction to be able to tick off the items, one by one.

4-Harness Overshot

To those of you not familiar with this large family, they are shown in The Shuttle-Craft Book of American Hand-Weaving, by Mary M. Atwater, pp. 158-203. Each section classifies the drafts according to "figure" and type. (A figure is a unit of pattern, e.g., "star", "rose", etc.)

Series I "Diamond and Cross Family", has several drafts with short overshots, suitable for borders on towels, on luncheon pieces, etc. An overshot, by the way, is a skip or float of pattern weft thread over a firm background surface. This background is obtained by having the "A" tabby follow one pattern weft shot, and the "B" tabby follow the next pattern weft shot. The two tabbies alternate continuously throughout the weaving. Most weavers throw the "A" tabby from one side consistently, say, from left to right, and the "B" tabby likewise consistently from right to left, to keep the tabby order constant regardless of the pattern throw. A throw or shot is one pass of the weft thread. The tabby is plain or "darning" weave.

What to learn about the 4-harness overshot weave

1. How to know whether the draft is a "balanced" one or not.
2. How to draw-down a draft to square the pattern, and how to write the basic treadling from this (we do an example for you on page 33).
3. How to write a draft from a 4-harness sample or photograph.
4. How to manipulate border drafts to match any given pattern draft so as to match border figure with centre pattern figures.

2. The draft is constructed to weave pattern and tabby. Every other warp end is "even" numbered and the alternate warp ends are "odd" numbered: every "even" numbered thread is on harness 2 or 4, every "odd" numbered end is on harness 1 or 3. Hence, to produce a tabby weave, harness combinations 1 and 3 ("B" tabby), and 2 and 4 ("A" tabby), are used alternately. (It is true that some ancient drafts are written so that the tabby sheds are produced by the 1-2 and 3-4, or the 1-4 and 2-3 harness combinations. However, the great majority of modern drafts are written as noted above, with the tabby sheds produced by the 1-3, 2-4 combinations. Many examples in Beriau use these ancient Scandinavian or Germanic drafts.)

3. This construction makes the rule that no end may be drafted from harness 1 to harness 3, or from harness 2 to harness 4, or vice versa, else the tabby order is disturbed.

4. Pattern treading combinations are found in pairs, by using harnesses 1-2, 2-3, 3-4, and 4-1.

5. The basic treading comes from the order in which these combinations or "blocks" are set into the draft.

6. Each "block", in its relationship to the adjoining blocks in the draft, has one warp end in common, e.g., in the first two blocks of the Russian Diaper, 1-2 and 2-3, "end 2" is common to both blocks.

With the foregoing mastered, we analyze that draft (read across):

Warp End Nos.	Combinations or "blocks"	Warp end in common	Treadling Harnesses - Treadle	
1,2,3,4	1212}	2	1-2	1
4,5,6,7	2323}	3	2-3	2
7,8,9,10	3434}	4	3-4	3
10,11,12,13	4141}	1	4-1	4
13,14,15,16,17	12121}	1	1-2	1
17,18,19,20	1414}	4	4-1	4
20,21,22,23	4343}	3	3-4	3
23,24,25,26	3232}		2-3	2

The draft ends with the 2-3 group, and the 1-2 combination appears when the draft is repeated.

Column 4 now lists our basic treadling. We go further to fix the number of repeats of weaving for each of these treadlings. When drafting on paper, the general rule is: repeat treadling one less time than the number of ends drafted in each combination or block. At the loom, the weight of weft, the warp setting, etc., are the factors which determine the number of pattern shots used for each block. On paper, then, the numbers of treadlings arrived at from the Russian Diaper draft are:

<u>Drafting order</u>	<u>Treadling (harnesses)</u>	<u>No. of ends in combination or block</u>	<u>No. of times to treadle</u>
1212	1-2	4	3
2323	2-3	4	3
3434	3-4	4	3
4141	4-1	4	3
12121	1-2	5	4
1414	4-1	4	3
4343	4-3	4	3
3232	3-2	4	3

Thus, we come to the final capitulation:

Basic Treadling, Russian Diaper draft

Harnesses	1-2 (treadle 1),	3	times
	2-3	2	3 "
	3-4	3	3 "
	4-1	4	3 "
	1-2	1	4 "
	4-1	4	3 "
	3-4	3	3 "
	2-3	2	3 "
	1-2	1	4 " (beginning of second pattern repeat, which gives a 12121 group).

Using the foregoing, we weave on paper, using graph paper having 10 squares per inch. The weaving effect is shown by a dash for an overshoot and a dot for a 1-thread skip, known as a "half tone". In such a draw-down it is well to include at least a portion of the second pattern repeat, as indicated below:

(second repeat)	1 st	2 nd	3 rd	Begin
4 4	4 4 4	4 4 4	4 4 4	4
3 3 3	3 3 3	3 3 3	3 3 3	3
2 2 2 2 2	2 2 2 2 2	2 2 2 2 2	2 2 2 2 2	2
1 1 1 1 1	1 1 1 1 1	1 1 1 1 1	1 1 1 1 1	1

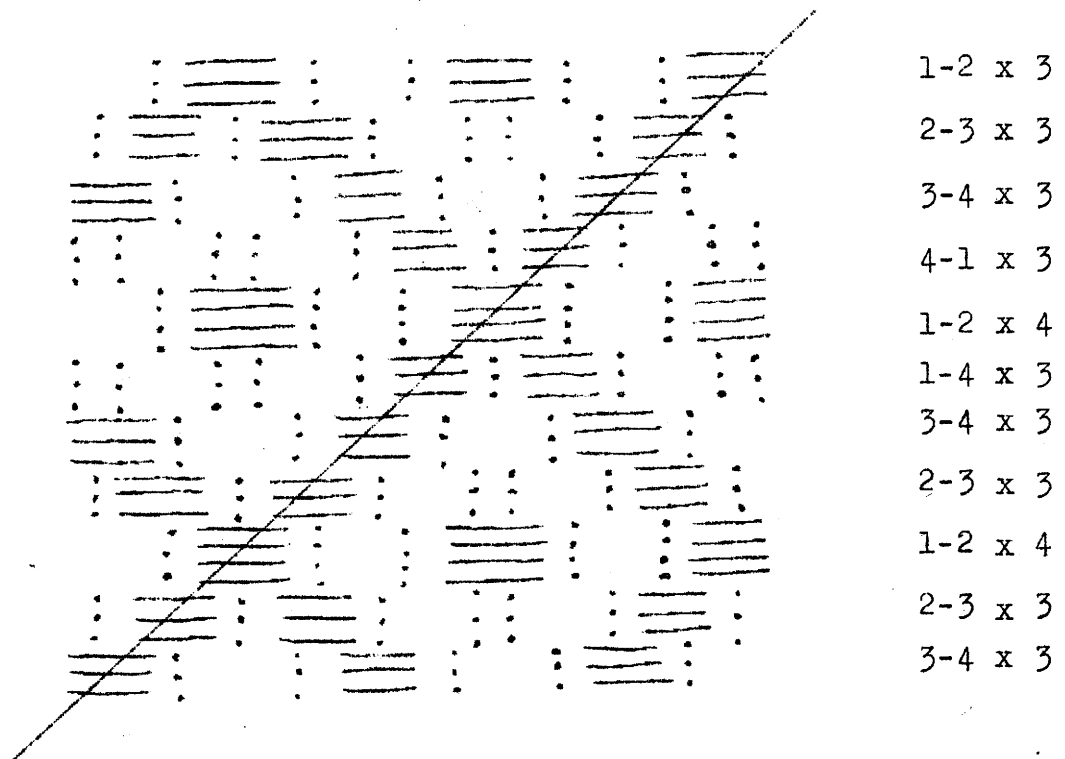

Note the one-thread overlapping of the blocks at the site of the common end between the combinations; note the diagonal.

To translate the draw-down in terms of the loom, hold the paper upside down, looking through the paper from its under side toward the light.

The above treadlings are for the counterbalanced loom, and would need the usual adjusting if used on the rising shed loom, i.e., for 1-2 use 3-4, for 2-3 use 1-4, for 3-4 use 1-2, for 1-4 use 2-3.

Weaving "as drawn in"

To weave "as drawn in" at the loom we will produce the same pattern which we obtained on paper from the basic treadlings worked out above, -- provided of course the loom is threaded with that draft. However, to weave "as drawn in", the paper draw-down of the draft should be done after the weaving and not before the exercise at the loom.

We will consider that your loom is before you, threaded with any 4-harness overshot draft, that you have no treadling directions, and that a piece is to be woven "as drawn in". Start by weaving a tabby heading, and use tabbies, of course, throughout the weaving.

1. Open the pattern sheds in order: 1-2, 2-3, 3-4, 1-4.
2. Examine the lower right hand edge only, where the tabby heading ends, to see where the spaces appear while sheds are open -- these spaces denote the position of the overshots.
3. Choose, by elimination, the overshot space nearest the right hand edge of the weaving.
4. Treadle this combination, throwing enough pattern shots (alternate tabbies between them) until the space you have chosen at the right hand edge is a small square of color (Spot "A" below).
5. Then, choose the treadling combination which gives a space to the left of Spot "A". This space must have as its first end, the last end of "A". Weave this space or overshot, also with enough pattern shots to give a square of color - "B".
6. No. 5 is repeated, and after an inch or so is woven, a diagonal line of squares rising at an angle of 45° , from the lower right hand edge, should appear very definitely. Their size may or may not be uniform, according to the number of ends.

drafted in any one combination:

In making a choice of the next proper treadling, disregard all other pattern areas except those along the diagonal -- this diagonal is the guide throughout the exercise.

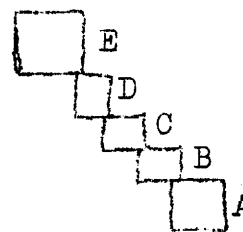

Continue No. 5, and the diagonal will finally reach the left-hand edge, nothing but your eye and judgment deciding your treadling.

This, then, is that teaser, "Weave as drawn in".

Treadling Variations

This means a free use of the four treadling combinations, as one desires, to produce a pleasing effect when woven. The number of possible variations is practically unlimited, especially interesting with a draft which produces small figures.

To weave a balanced border or band, we weave to a central point and reverse the treadlings. For example:

harnesses 1-2, 2 times	
2-3, 6 times (centre)	
1-2, 2 times	
	<u>or</u>
	1-2, 3 times
	1-4, 2 times
	1-2, 5 times
	2-3, 4 times (centre)
	1-2, 5 times
	1-4, 2 times
	1-2, 3 times

It is advisable to have an even number of pattern shots as the centre treadlings of a band, so that the other pattern shots will be "bound" together or apart in a similar fashion by the tabbies, at each side of the centre. An "odd" number in the centre will produce a different effect. Otherwise, one is confined by no rules, treadling order, number of treadling repeats, color, pattern weft medium, or uniformity of color in tabby background, -- all these are at your disposal, for use as you wish.

Our "assignment" for you this month

1. Choose a draft and from it work out its basic treadingling on paper (for this we suggest #8 in the Shuttle-Craft Book).
2. "Draw-down" this draft to weave on squared paper (8).
3. Working at the loom, without previously determining its basic treadlings, weave a draft "as drawn in" (#69 Shuttle-Craft).
4. Weave a sampler of original variations. For the sampler we suggest Honeysuckle (#6 Shuttle-Craft), or, another versatile small pattern, Periwinkle (p.14, The Weaver's Quarterly, April, 1939), since this is the threading used for the woven sampler to be photographed in the June issue:

	42	40					30					20				10	Begin		
	4		4				4	4	4			4				4	4	4	4
							3	3	3			3				3	3	3	3
Periwinkle	2		2	2	2				2			2	2	2				2	2
	1	1	1	1			1	1	1			1	1	1				1	1
																			1

Warp: Egyptian cotton, 24/3 natural, at 30 ends per inch, single in heddles, double in a 15-dent reed, 13" wide, 390 ends.

Tabby: Same 24/3 natural.

Pattern Weft: About double the grist of the warp. Ours used Lily's Frost-Tone in a soft blue throughout, and was woven 31" long plus hems. The use of three or four harmonious colors, used in carefully planned pattern bands, can make a valuable contribution to your experience in the combining of colors in weaving.

1. Draw outline of planned sampler piece on paper, full size.
2. With a ruler, plan borders of varying widths, each a different size, but avoiding doubles or halves of any other

borders. The inter-spaces of tabby may be the same width throughout (ours were 1/2" wide generally, except that when two or three narrow pattern bands composed a unit, the inter-spaces were narrowed). Our sampler was planned to hang on the wall, so that wider bands occur near one end, while the end bands are of equal width.

3. Make your own treadlings at the loom! For balanced borders, weave half desired width, then reverse treadlings for the remaining half. Be sure to record border widths, treadlings, and all the details -- just as we hope you keep accurate records of all your weaving.

Once the weaver recognizes that original variations are possible for any 4-harness overshot draft, the need for specific directions for bands of decoration has passed away, and a long step forward has been taken in freeing one's self from being the hand-maiden of a small slip of paper!

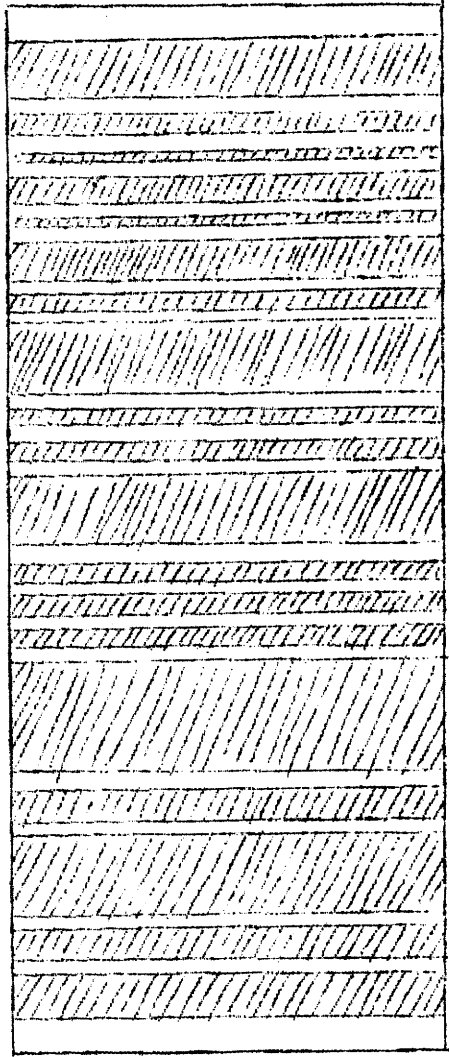

Good weaving!

Ethel Henderson
 Mrs. E. M. Henderson
 20 Ritz Apartments
 Winnipeg, Manitoba

Mary Sandin
 Mrs. R. B. Sandin
 University of Alberta
 Edmonton, Alberta

Per year \$3.00
 Single copy .35
 Copyright 1945

LOOM
MUSIC

VOLUME II

NUMBER 5

MAY, 1945

Mary
Sandin
Edmonton

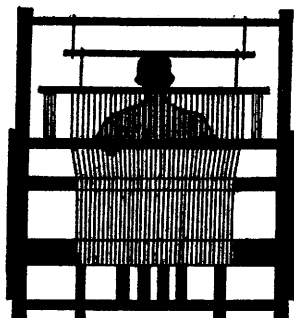

Ethel
Henderson
Winnipeg

L O O M M U S I C

Volume II, No. 5

May, 1945

COTTON UPHOLSTERY IN SUMMER AND WINTER WEAVE

We are enjoying an early Spring, and all sorts of spring plans are to the fore. Housecleaning is upon us, and we turn the pages of our magazines and weaving books looking for help in brightening up our home surroundings. Cool slip covers, new cushion covers, crisp curtains, new bedroom accessories, -- all are possible to us who weave. Although our choice of material is limited, we can plan to very considerable advantage within these limits.

One of our Edmonton weavers, after planning with us, recently completed a length of light-weight upholstery material, which has been greatly admired. It was woven in natural, and deep ecru, in a small two-block "Summer and Winter" arrangement. It is most attractive on the wing chair for which it was woven, and reminded us that we have not yet had a Summer and Winter draft in our bulletin. It should also prove to be a fine exercise for our many weavers who are quite familiar with four-harness overshot, but who have not yet woven Summer and Winter weave. Our eight-harness weavers already have so much material available, and are so few in number compared with the growing numbers of 4-harness weavers, that we find ourselves speaking mostly to the latter.

We have had a number of requests from craftsmen, asking that we include notes on the construction of a weave, to accompany the draft for which specific directions are being written. While the basic principles of such weaves as Summer and Winter are

already adequately reported and are available in books which we have mentioned before (Mary M. Atwater's Shuttle-Craft Book, and Helen Louise Allen's American and European Hand Weaving Revised, to name only two), some of our weavers who have not access to weaving libraries feel the need of explanations which supplement work previously published by outstanding weavers. To weave "blindly", without some knowledge of the weave, is to get only a fraction of the joy which comes with true weaving. For this reason, whenever possible, our drafts will carry a little accompanying essay.

Summer and Winter always brings to one of us memories, amusing now, but a real headache at the time. The scene shall be nameless! A warp was being threaded into an 8-harness Summer and Winter, and a "short draft" was given to one of us. We looked at it, and looked and looked, never having encountered a draft of this type before. When the needed knowledge was finally tracked down and mastered, it was never forgotten, and has always served as a vivid reminder of the need to stress a combination of theory and practical work.

Summer and Winter is probably not used as commonly as the twills, the 4-harness overshot, or the linen weaves, but is nevertheless a most noteworthy member of the weaving family. It does not show its greatest design possibilities when used on four harnesses, but six and eight harnesses find it displaying all its brilliant variety of pattern.

Summer and Winter weave produces a closely combined fabric, the weave consisting of a series of 3-thread skips "tied down" by a fourth thread, over the pattern area, and an under skip of three threads tied down with a fourth, where the background appears. This creates a reversible fabric, light against dark, and vice versa. It is probable that this quality of the weave

gave rise to the name Summer and Winter weave.

The pattern is formed by groups of these three-thread skips and tie-downs on the various harnesses. Each group is called a block, and requires three harnesses to form it. Since we can have only two 3-harness combinations and still keep within the requirements of the draft, only two blocks or areas of pattern are at our disposal on a 4-harness loom. Each added harness on the loom increases the pattern possibilities by one block. Thus, on a four-harness loom we can weave a 2-block summer and winter pattern, a 3-block pattern on five harnesses, a 4-block pattern on six harnesses, and so on. On eight harnesses, a 6-block pattern is possible, and the threading for each block is as follows:

the first block is threaded	1,3,2,3
second	1,4,2,4
third	1,5,2,5
fourth	1,6,2,6
fifth	1,7,2,7
sixth	1,8,2,8

Since the form of the individual block never varies, it is customary to show the draft in a "short form". The two front harnesses operate the threads which tie-down every fourth thread in the pattern areas, and are not usually indicated in the short draft. The numbers above the draft indicate how many times each block is repeated, and at the end of the draft the total number of warp ends is given. Since each block represents four warp ends, the total number of warp ends will be four times the number of units in the draft. Below is an example of how a six-block draft in its short form might appear (for actual drafts and illustrations, see Mrs. Atwater's Shuttle-Craft Book or her Recipe Book).

27 units,
108 threads

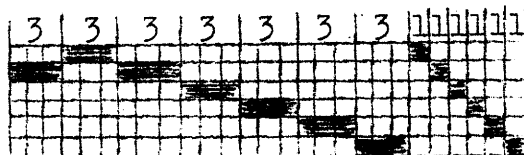

The threading of the above draft would therefore read:
1,3,2,3, 1,4,2,4, 1,5,2,5, etc.

It will be noted that there is no limit to the number of times a block can be repeated, thus allowing large areas of pattern to be woven. In the multiple harness tie-ups, it is also possible to have the blocks overlap, thus adding to the design possibilities. Too, a whole draft may be changed in appearance by changing the tie-up, or the manner in which the harnesses are used together. Similarly, the draft for a 4-harness Summer and Winter weave will look like this:

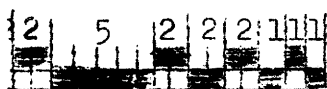

16 units, 64 ends

The draft will be seen occasionally in its "long form", where each individual warp end is shown:

etc.	4	4	4	4			4	4									4	
						3	3				3	3						3
	2		2		2			2		2		2						2
		1		1		1		1		1		1		1				1

Note that every other end is threaded on harnesses 1 and 2, and the remainder on harnesses 3 and 4. Thus, the tabby in Summer and Winter is always harnesses 1 and 2 against all the other harnesses.

The balance of material used in warp and weft is very important, since each block of the pattern is customarily woven so that it forms an individual square. The tabby should be finer than the warp, and the pattern thread about the same weight as the warp.

Details of Cotton Upholstery Material

The draft which Miss Campbell used for her ecru and natural upholstery material, which we mentioned on the first page,

is as follows:

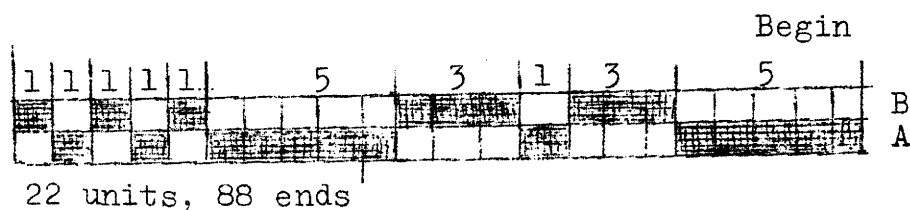

All blocks on A are threaded 1,3,2,3 for each unit;
all blocks on B are threaded 1,4,2,4 for each unit.

Summer and Winter, Two-Block Tie-up

Blocks		Tabby			
A	B				
	x	x		x	4
x	x			x	3
	x		x	x	2
x		x		x	1
1	2	3	4	A	B

Sinking Shed Loom

Blocks		Tabby			
A	B				
o	o			o	4
		o	o	o	3
o		o			2
	o		o	o	1
1	2	3	4	A	B

Rising Shed Loom

Materials Used. - Since material was not available in the desired colors to conform with the ideal weights given on page 41, and standard 16/2's and 8/2's were used instead, some treading adjustments had to be made in order that the blocks would be square when woven. Therefore we are giving below the actual material used, with notes on the necessary adjustments.

The Warp: 16/2 cotton in a deep ecru. For material 31½ inches wide in the reed, approximately 950 yards of 16/2 per yard of warp will be needed (948 warp ends times length desired, plus 27" for loom waste).

The Tabby: 16/2 cotton in a deep ecru (finer tabby should be used if available). Amount: a little less than the warp requirement.

The Pattern: 8/2 mercerized cotton in natural color (finer pattern weft should be used when the finer tabby is available). Amount: a little less yardage than the warp requirement.

Setting: 30 ends per inch, single in the heddles, double in a 15-dent reed.

Threading Plan:

10 repeats of pattern draft, as detailed below: 880 ends
 (Block A, 1,3,2,3, five times: 20 ends
 B 1,4,2,4, three " 12 "
 A 1,3,2,3, once 4 "
 B 1,4,2,4 three " 12 "
 A 1,3,2,3 five " 20 "
 B 1,4,2,4 once 4 "
 A 1,3,2,3 once 4 "
 B 1,4,2,4 once 4 "
 A 1,3,2,3 once 4 "
 B 1,4,2,4 once 4 "
 88 ends)

To balance: threads 1 to 68 68 ends
948 ends

The Treadling: This weaver preferred the effect obtained when Tabby A is thrown between pairs of pattern shots, and the treadlings are given as used.

With ecru tabby, weave a 1-inch heading: Tabby A, B, A, B, etc., ending on tabby A.

Since the treadling is strictly "as drawn in", it follows the same order as the threading plan above. For convenience we are dividing it into Group I and Group II:

<u>Group I</u>	<u>Treadling unit</u>	<u>Repeat the unit</u>
Block A	Treadle 1,B,2,A,2,B,1,A	5 times, in all
B	" 3,B,4,A,4,B,3,A	3 times "
A	" 1,B,2,A,2,B,1,A	1 time
B	" 3,B,4,A,4,B,3,A	3 times "
A	" 1,B,2,A,2,B,1,A	5 times "

Group II

Block B	Treadle 3,B,4,A,4,B,3,A	1 time
A	" 1,B,2,A,2,B,1,A	1 time
B	" 3,B,4,A,4,B,3,A	1 time
A	" 1,B,2,A,2,B,1,A	1 time
B	" 3,B,4,A,4,B,3,A	1 time

Repeat Group I and Group II alternately throughout the entire weaving. Every treadling unit should be "squared", and a diagonal line should rise from the lower right hand corner of the

weaving, at a 45° angle. (NOTE: with the materials which were used in the piece of weaving referred to, in order to "square" the larger blocks, it was found necessary to reduce the number of repeats of the A block from 5 to 3, and of the B block from 3 to 2). Care should be taken that complete units of 4 pattern shots each are woven, -- never less than the complete 4-thread treadling unit.

Anyone can work out his or her own designs, arranging threadings of Blocks A and B in whatever proportions are pleasing and suitable to the article being planned. The alternation of one threading unit of Block A and one threading unit of Block B across a whole threading will weave a most attractive small diamond design, particularly suitable for the upholstery material for use on small chairs. Because of its construction, the Summer and Winter weave is excellent for bags, pillow tops, draperies, in addition to upholstery material.

Two of our western weavers would like to purchase used Structo looms, the No. 240, 8-inch loom, and the No. 600 or No. 712, 20-inch loom. Another weaver wants to buy a copy of Worst's How to Weave Linens, and still another would like d'Harcourt's Les Textiles anciens de Perou, etc. We ourselves would like to locate new or second hand Scandinavian weaving books, to be purchased by the University for use in connection with our work at the Banff School of Fine Arts. If you have any one of the above for sale, please send details to Mrs. Sandin.

Mary Sandin
 Mrs. R. B. Sandin
 University of Alberta
 Edmonton, Alberta

Ethel Henderson
 Mrs. E. M. Henderson
 20 Ritz Apartments
 Winnipeg, Manitoba

Per year \$3.00
 single copy. .35
 Copyright 1945

SUMMER AND WINTER UPHOLSTERY MATERIAL

"Short form" of Draft, squared to show woven effect.

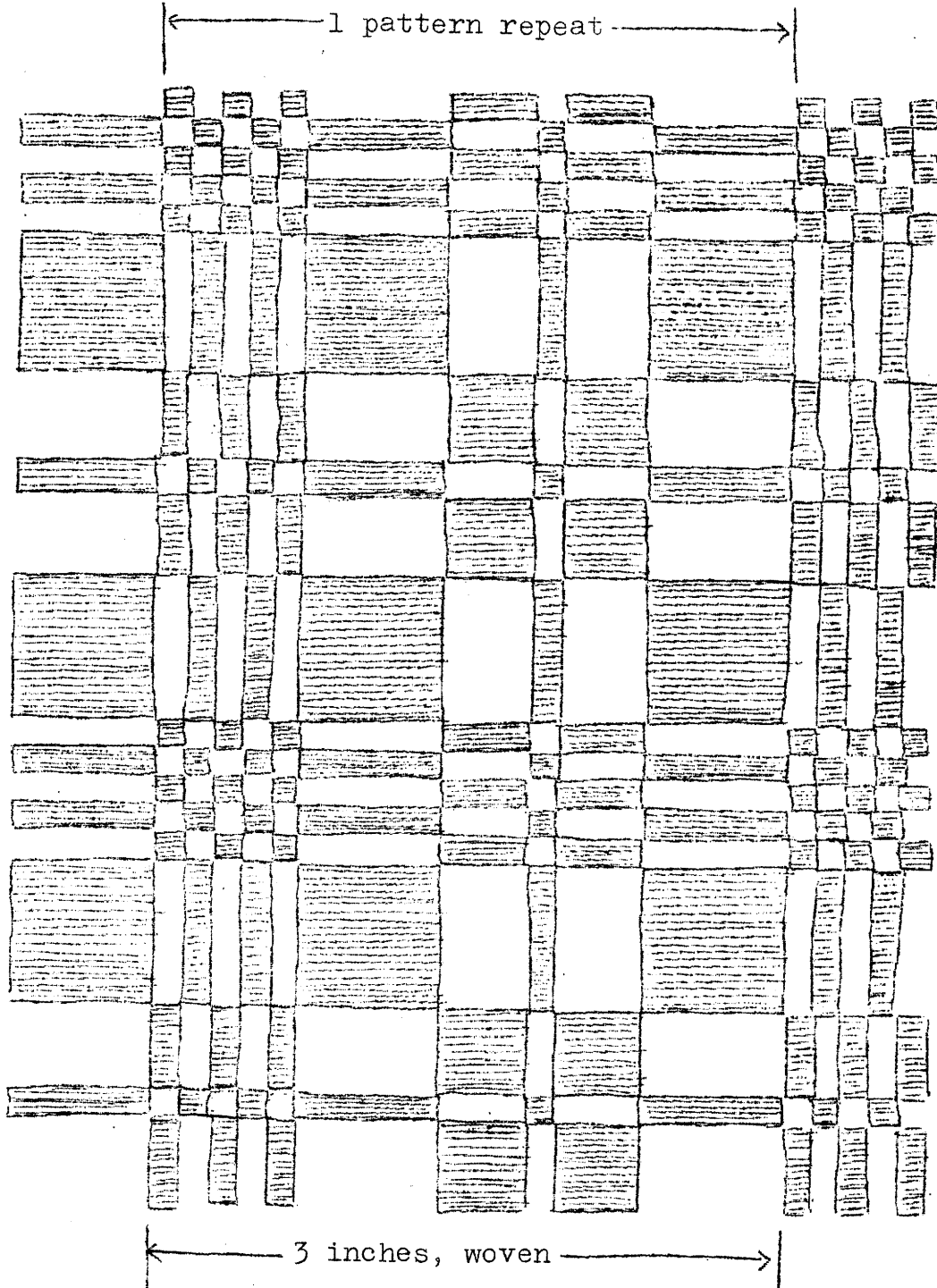

LOOM

MUSIC

VOLUME II

NUMBER 6

JUNE, 1945

Mary
Sandin
Edmonton

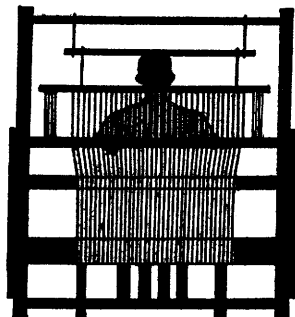

Ethel
Henderson
Winnipeg

L O O M M U S I C

Volume II, No. 6

June, 1945

VARIATIONS ON A 4-HARNESSED OVERSHOT THEME

The end of a long warp, say fifteen or twenty yards, brings with it a grand feeling of accomplishment -- and sometimes of thankfulness. It means reaching the climax of a weaving assignment, and greater still, the thrill of unrolling the web and gloating over a feast of well-done labor. When several quite different types of treadling have been used for variety, our work goes quickly, and we usually find at the end that we have developed a particular liking for some one treadling. Rather vague statements such as the above about getting variety on a long warp bring forth the following response from weavers with whom we are in contact: "What exactly do you mean? Give us a concrete idea of the variations you have in mind." "Ah, ha!", we respond, -- "There's material for a bulletin", -- and without further ado we give you a few interesting, attractive, and practical ways to weave off a length from the warp beam, all done on a simple overshot threading.

For such a project we recommend a 4-harness overshot draft with small skips, and for ours we used the Periwinkle draft which we mentioned in our April bulletin, page 36. For convenience we repeat the draft and tie-up here:

	Begin																		
Periwinkle	4	4				4	4	4		4		4	4	4			4	4	
Threading Draft				3	3	3			3		3			3	3	3		3	3
	2	2	2	2				2		2	2		2			2	2	2	2
	1	1	1	1				1	1	1		1	1	1			1	1	1

Tie-up

		X	X		X		4
	X	X				X	3
X	X				X		2
X			X			X	1
	1	2	3	4	A	B	

Sinking Shed Loom

O	O					O	4
O			O			O	3
		O	O			O	2
	O	O				O	1
	1	2	3	4	A	B	

Rising Shed Loom

Warp: One of the most satisfactory warps is a natural 24/3 Egyptian Cotton (the Searle Grain Co., Winnipeg, Manitoba, is now another Canadian source for this material), about 13 inches wide, at 30 ends per inch, single in the heddles, double in a 15-dent reed. Warp 15 or 20 yards long, as desired.

Tabby: The same 24/3, natural color.

Pattern Weft will be noted with each variation listed below.

Threading Guide

<u>Border</u>		
1234	times 8	32 ends
<u>Pattern</u>		
1212	times 7	294 ends
3234		
3414		
1214		
3212		
3412		
1414		
3432		
3212		
1412		
14		
<u>Balancing group:</u>		
thread 1 to 37 of pattern,	times 1	37 ends
<u>Second border</u>		
4321	times 8	32 ends
		<u>395 ends</u>

VARIATION I - Guest towel with $1\frac{1}{2}$ " band of color at each end, in pattern weave

Material: 8/2 natural for body of towel, 24/3 for tabby in pattern area, and for colored pattern bands: Lily Mills "Skytone", or 8/2, or 6-strand embroidery cotton split into 3's, in a soft medium blue.

The Weaving:

Weave $\frac{1}{2}$ " tabby with 24/3, for hem's first turn-in.
(Treadles 5 and 6 used alternately).

Weave $2\frac{1}{2}$ " tabby, using 8/2 natural.

Weave pattern band in blue, with tabby of 24/3 throughout the band:

Treadle	2, twice	
	1, twice	
	2, twice	
	1, twice	
	4, twice	
	3, twice	
	2, twice	
	1, twice	
	2, once	
	3, once	
	4, once	
	1, twice	(centre)
	4, once	
	3, once	
	2, once	
	1, twice	
	2, twice	
	3, twice	
	4, twice	
	1, twice	
	2, twice	
	1, twice	
	2, twice	

Weave 15" tabby for towel's centre, using 8/2 natural.

Repeat pattern band.

Repeat $2\frac{1}{2}$ " tabby with 8/2 natural for hem.

Repeat $\frac{1}{2}$ " tabby with 24/3 for turn-under.

Other color combinations for the pattern bands and main part of towel might be:

White towel with yellow pattern and white tabby,
Light blue towel with peach pattern and light blue tabby,
Dark blue towel with light blue pattern and dark blue " ,
Peach towel with pale green pattern and peach tabby,
Green towel with mauve pattern and pale green tabby,
Purple towel with mauve pattern and purple tabby.
White towel with turquoise pattern and whitetabby,
Mauve towel with white pattern and mauve tabby.

Some delightfully textured guest towels were just

finished by a friend, using a mercerized 20/2 cotton for weft and pattern, Pastels were used as suggested above, and they were really most attractive. Make 5 or 6 towels with different colored bands, and already 3 yards of warp are accounted for at this point.

VARIATION II - "All over" design

These runners, made in varying sizes, will find a home on bedside tables, in greater lengths on bureaus and chifforobes, etc. The pattern is somewhat too fussy and we think unsuitable for place pieces, unless used with absolutely plain white china.

Material: Turquoise "Skytone" for pattern, with tabby of 20/2 mercerized (or 16/2 if you haven't the 20/2).

The Weaving:

Weave $\frac{1}{2}$ " tabby with 20/2 for hem's first turn-in.

Weave 2" tabby with turquoise, for hem.

With turquoise pattern and 20/2 tabby
 treadle 2, twice
 treadle 1, twice
 treadle 2, twice

Weave 10 shots tabby using turquoise.

With turquoise "Skytone" pattern weft and 20/2 tabby, weave the body of the runner. NOTE: These are the "as drawn in" treadlings referred to in LOOM MUSIC for April, 1945, and may be of some check in that connection -- you shouldn't need them!

treadle 1, once	} at beginning only
2, once	
3, once	
4, once	

★ treadle 1, three times
 2, three times
 3, three times
 4, three times
 1, twice
 4, once
 3, once
 2, once

(continued)

treadle 1, twice
 2, once
 3, once
 4, once
 1, twice
 4, three times
 3, three times
 2, three times
 1, three times
 4, twice
 1, twice
 4, twice ★

Repeat treadlings from ★ to ★ for 15" or more, depending on the length desired. On the last repeat, omit the final three treadlings, and match the first end by treadling

treadle 4, once
 3, once
 2, once
 1, once

Weave 10 shots tabby using turquoise.

With turquoise pattern and 20/2 tabby

treadle 2, twice
 1, twice
 2, twice

Weave 2" tabby with turquoise, for hem.

Weave $\frac{1}{2}$ " tabby with 20/2 for hem's first turn-under.

VARIATION III - Washable summer purses

Now for some real fun and speed. With coarse weft and a fine tabby, our shuttle fairly flies along. Get out your mop cotton, or 12/4, or six strand filler, or candlewick. In white or pastels, these make grand summer purses -- washable, easily made up, with no lining necessary! (A private confession, -- we hate fitting linings into articles!)

The Weaving:

With 24/3 natural, weave $1\frac{1}{2}$ " tabby.

With heavy weft, and with 24/3 as tabby between weft

shots:

Treadle 1, once
 2, once
 3, once
 4, once
 1, once
 2, once
 3, once
 4, once
 1, once
 2, twice
 1, once
 4, once
 3, once
 2, once
 1, once
 4, once
 3, once
 2, once
 1, once
 4, twice

Repeat the above treadlings, beating firmly, until about 16 inches are woven. On the last repeat, omit the last treadling.

Weave $1\frac{1}{2}$ " tabby with 24/3 natural.

The above is planned for a zipper bag, about 7 x $12\frac{1}{2}$ " finished. Machine stitch the tabby ends before cutting. The zipper should be basted to the tabby heading, so that the metal part lies along the first pattern shot, and then stitched down twice on the sewing machine. Then hem the tabby down on the inside of the bag, using hand stitching. Last, with the bag right side out, overcast the edges together neatly, using thread the color of the pattern weft.

Perhaps you would rather plan an envelope purse than shop around for a zipper. In that case, weave extra tabby in 24/3 at one end, - enough to hem down and serve as a lining for the width of flap which is desired.

You'll want to make lots of these, using a yard or more of your warp per pair.

VARIATION IV -- Place Mats

So often in using cotton for place mats, the finished

product is not heavy enough to "stay put" on the table, especially if 16/2's or 24/3's was used throughout. Here is a treadling and material which give a very firm fabric, suitable for luncheon or informal use. Hems or fringes may be used, -- we are suggesting hems here because of their longer life.

For these we used No. 5 perle cotton in pastels, -- pink and rose, with black for emphasis. The tabby is the 24/3 natural Egyptian. The finished mats show definite lengthwise strips of the pattern weft, very firm and durable, since the weft skip is short.

The Weaving:

Weave $1\frac{1}{2}$ " using 24/3, tabby weave, for hem.

With rose perle #5, with alternating A and B tabbies of 24/3 between pattern shots, treadle 4 for $1\frac{1}{2}$ ". That is

treadle 4, with rose
 tabby A, with 24/3
 treadle 4, with rose
 tabby B, with 24/3, etc., for $1\frac{1}{2}$ "

With 4 strands of black perle #5
 treadle 1, once)
 3, once) without using tabby
 1, once)

With pink perle #5
 treadle 1, perle
 tabby A, with 24/3
 treadle 1, perle
 tabby B, with 24/3, etc., for 14" in all.

Repeat treadle 1,3,1, with 4 strands of black.

Repeat treadle 4, rose, A, 4 rose, B, etc., for $1\frac{1}{2}$ "

Repeat $1\frac{1}{2}$ " tabby weave, 24/3, for hem.

Always machine stitch between mats before cutting, then hem back to the first row of rose pattern-weft.

VARIATION V - Towel with "honeycomb" borders

Our last variation for this month's bulletin is the ever

attractive "honeycomb" technique. In Scandinavian weaving, where this weave seems to have originated, it has several names according to the type of depression, - "Gagnefkrus" (curly weave) or "Spetsvav", to name only two. It has almost endless treadling variety, and the weave deserves much more space than given here. We include only one treadling, for towel borders. In general, the weave is more suited to articles like pillow tops or bags, where the wrong side is covered.

For this variation, one must untie one tie on each of the four pattern treadles, leaving the tabby treadles as usual, since the woven effect is gained by using each harness alone for the pattern shots. The tie up will be the direct one:

			X		X	4
		X			X	3
	X			X		2
X					X	1
1	2	3	4	5	6	
				A	B	

The Weaving

With deep mauve 16/2, weave 2½" tabby for hem, ending on tabby B.

With white perle #5, treadle A tabby once.

With deep mauve 16/2, weave 8 shots of treadle 1 and treadle 2 alternately, without tabby.

With perle #5, tabby B, tabby A, and beat well.

With mauve 16/2, weave 8 shots treadles 2 and 3 alternately, without tabby.

With white perle #5, tabby B, tabby A.

With mauve 16/2, weave 8 shots treadles 3 and 4.

With white perle #5, tabby B, tabby A

With mauve 16/2, weave 12 shots treadles 4 and 1.

This is the centre treadling, -- reverse treadlings for second half of border.

With mauve 16/2, weave 16" in tabby, ending on tabby B.

Second honeycomb border:

With coarse weft (white perle #5), tabby A

With fine weft (mauve 16/2), 8 shots of treadles 1 and 2 alternately, no tabby.

Coarse, tabby B, tabby A.

Fine, 8 shots treadles 2 and 3 alternately.

Coarse, tabby B, tabby A.

Fine, 12 shots treadles 3 and 4 alternately.

Coarse, tabby B, tabby A.

Fine, 12 shots treadles 2 and 3 alternately

Coarse, tabby B, tabby A.

Fine, 8 shots treadles 3 and 4 alternately.

Coarse, tabby B, tabby A.

Fine, 12 shots treadles 1 and 2 alternately. CENTRE.

Reverse treadlings from this centre to beginning of band.

With mauve 16/2, weave 2½" tabby for hem.

We are sure our weavers will now see the end of the warp in sight, after carrying out the suggested variations, plus others which invariably occur to the weaver as he goes on weaving. Probably not enough warp was put on the first time and another warp will be made and "tied on", - that is, each new warp end is tied separately to the ends already in the reed, then the new warp beamed, -- and away for more yards of weaving.

We have another group of variations to go along with these, - let us know if you would like the second edition soon.

Photographs of these variations on page 55 will help you to visualize the finished articles. (p.55 with your July issue).

Good Weaving!

Ethel Henderson

Mrs. E. M. Henderson
20 Ritz Apartments
Winnipeg, Manitoba

Mary Sandin

Mrs. R. B. Sandin
University of Alberta
Edmonton, Alberta

Has anyone a small eight harness loom of the jack type to sell to one of our Ontario weavers? If so, please send details to either one of us.

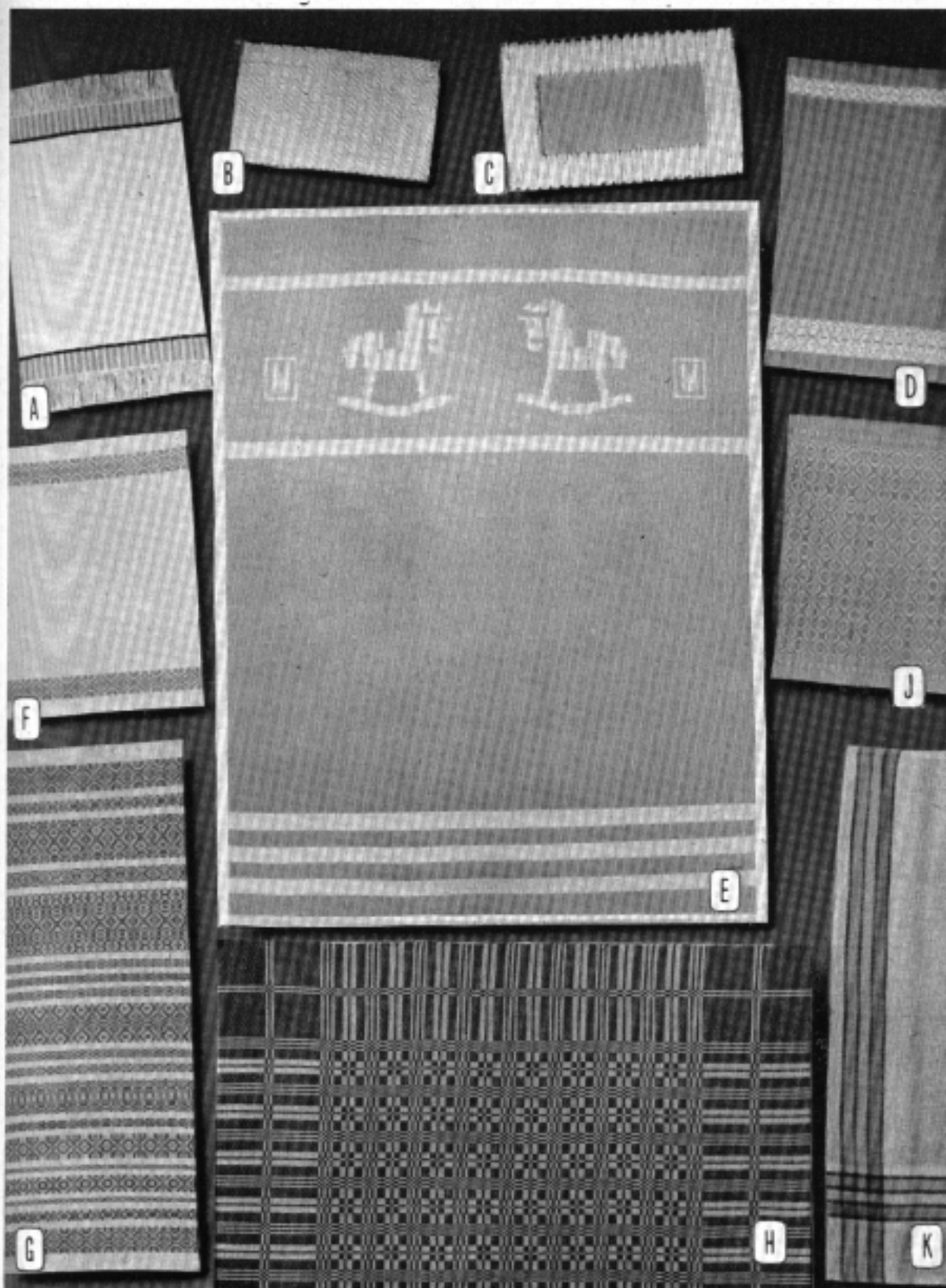

A. June

B. June

C. February

D. June Honeycomb

E. March—Double Weave, Miss Wilma Watson, Edmonton

G. April—Sampler

J. June "As Drawn In"

F. June

H. May—Summer and Winter, Miss Lena Campbell, Edmonton

K. January—Madame Talbot, Winnipeg

LOOM
MUSIC

VOLUME II

NUMBER 7

JULY, 1945

Mary
Sandin
Edmonton

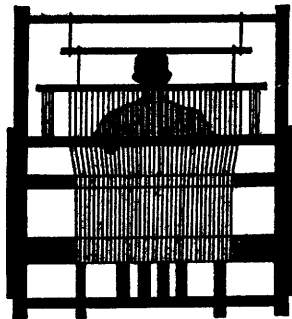

Ethel
Henderson
Winnipeg

L O O M M U S I C

Volume II, Number 7

July, 1945

SPANISH OPEN WORK

This weave is one to which we may turn when we wish to make a piece of weaving particularly our own, -- that is, the design is our own choice and personalized. It is essentially a linen weave, and in Spain the weave seems to be carried out with white linen only.

There is for sale in Canada at present plenty of bleached and unbleached linen of the coarse type found most suited to this weave. We also note in a recent advertisement of the Hughes Fawcett Co. in McCall's Needlework that linen is on its way from Ireland.

It is not impossible to have color in our own linen weaving, since many of our members are experts with the dye pot. However, linen is somewhat hard to dye and must be experimented with. While, of course, the softer more subtle effects are gained with vegetable dyes, the skilled blending of commercial dyes also produces pleasing colors. Any article which is to be laundered often must be color fast.

Many examples of this Spanish Open Work weave in ancient pieces are photographed in Mildred Stapley's "Popular Weaving and Embroidery in Spain" (William Helburn Inc., 418 Madison Ave., New York). Many beautiful weavings in this technique were done by the late Gertrude M. Howells, a former member of the Shuttlecraft Guild. It was she who introduced the weave into the United States a number of years ago.

Spanish Open Work is not for the weaver who will not take pains to achieve a good effect, but is a pleasure to the meticulous worker. The weaving process itself is very easy to master, and practise brings reasonable speed.

It is a one shuttle weave, and good results are obtained by using a flat stick-shuttle, sanded to a tapering round at each end. One we have always enjoyed using was made from a thin plastic ruler cut to use, the tips being at least an inch deep:



For design in this weave, the motif is worked out on 10 x 10 graph paper, each square representing one unit of the pattern, which in turn represents a certain number of warp ends. Quite elaborate effects are possible, as will be seen in the illustrations in Mildred Stapley's book. However, simple geometric designs are very well fitted to our use. The design may appear in plain weaving against an open work background, or, the design may be executed in the open work stitch, against a plain background. In this country the weave is not usually done with a very fine linen, a 40/2 or a #20 singles being a fair weight for warp, and a 40/3 round linen or linen floss a good weft. The weft is usually chosen coarser than the warp. Some interesting results may be obtained by using several weft ends together while doing the open work stitch areas, keeping to the single weft elsewhere in the weaving. A good illustration of this will be found on page 16 of Helen Louise Allen's book "American and European Handweaving Revised." This book, by the way, is out of print, but a new edition is expected to be off the press before long.

Let us then set up our warp, of #20 linen, or similar grist. We may wish to make place pieces 12 inches wide, dresser scarves 20 inches wide, or even square linen tea cloths. We will

select first a dresser scarf:

The Warp: #20 linen, set at 30 ends per inch (2 ends per dent in a 15-dent reed). Twenty inches x 30 ends per inch = 600 warp ends. Be sure that your linen is warp linen, since weft linen will give only trouble when used as a warp.

The Threading: The loom is threaded to produce plain or tabby weaving, -- set up in a twill on a four-harness loom: 4,3,2,1, 4,3,2,1, etc.

The Weaving: As is usual in weaving linen, the web should be kept damp during the weaving process. A sponge may be used to dampen the weaving surface, and a damp towel may be placed over the warp behind the heddles, and over the beam. It is well also to use a warp dressing on singles warp linen. This may be the same dressing as is used for wool, -- linseed, boiled in water, strained, and thinned to the consistency of thin starch, into which the chained warp is dipped, then squeezed out and hung to dry. The same dressing may also be applied to the warp after it is on the loom.

While we prefer a boat shuttle for most of our weaving, here it is best to start right out with the flat shuttle, wound with as much as it will conveniently hold, to avoid as many joins as possible.

With the chosen weft linen, #14 or even heavier, weave 6 inches of plain weaving before beginning pattern ($1\frac{1}{2}$ " for hem and turn-under, the balance for end border). End on Tabby B.

We will use Plate B, page 63, as our working sheet for the dresser scarf ends. Figuring is done on the basis of half the warp ends, since it is easier to count the ends on the top shed only. Our pattern is composed of 60 units across its widest part. Each unit represents 4 warp ends of the top half of the

warp when the tabby shed is open, or 8 warp ends counting the whole warp.

On the basis of half the warp ends, we calculate: Since our pattern shows 60 units at its widest part, it will require 240 warp ends, leaving 60 ends from our total of 300 warp ends, to be divided equally as borders at each side of the motif, -- 2" borders. The use of 4 ends per unit (8 complete warp ends) is a common basis for use with this weave.

In the Spanish stitch, care must be taken not to use the beater, else the proper open effect is lost. The edge and tips of the flat shuttle must do the work of beating. As only the tabby sheds are used, they will be designated as A and B.

First Pattern Row: Working from the right hand side of the loom, with shed A open, count in 78 ends to the left on the top half of the warp, and follow through to that point with the shuttle, bringing the shuttle up to the top surface of the work. Again, let us say that in counting, the bottom half of the warp is disregarded. Change to Shed B, insert shuttle in the shed and return it to the right hand edge. Press back weft with edge of shuttle, and do not use the beater. Change to Shed A, bring in the shuttle for the 78 warp ends, plus 4 warp ends more. Change to B shed. With the tip of the shuttle, press the weft down at the 4-end point just passed, then pass shuttle from left to right under these 4 warp ends. Pull weft slightly with the fingers to make sure an open spot results. Change to shed A and pass shuttle to the left under the 4 ends plus 4 ends more. Change to B shed, pat down the last group and pass shuttle to the right for the 4 ends.

Summing up: Each unit of the pattern is woven with

three weft shots, done on alternate tabby sheds. Where the pattern units occur in a continuous line, the weft passes through 8 warp ends going forward, and 4 warp ends going backward. Before beginning the pattern areas, the edge of 78 ends must be built up with three weft shots on alternate tabby sheds.

Continuing with the first pattern row on Plate B:

Thirteen groups of 4 threads each are completed as described above. Then, for the plain centre portion: 48 ends are woven ahead (this includes the last 4 ends of the 13th group), 44 ends back, and then 44 ahead plus 4 more ends. Thirteen groups of 4-thread units are then woven, leaving 78 ends for the left hand border of plain weaving. Don't forget the three treadlings here to build up the left edge, as was done on the right.

Three of the secrets of success in the Spanish Open Work are: (1) beating down each individual group of threads with the tip of the shuttle, (2) leaving sufficient slack in the weft thread over tabby areas to ensure good edges, (3) being sure that when tabby areas occur alongside pattern areas, the tabby areas are built up with the necessary three weft shots.

The sketch below shows clearly the three weft shots to each unit of pattern, and the building-up process at the edge of the work and between pattern areas. The second sketch shows the accentuation of the "holes" which is obtained by pulling the weft thread sufficiently to get the desired effect.

Open work stitch

Weft not pulled



Weft pulled to accentuate openings



When the above first row of open work stitch is

completed, the second row may be woven in either one of two methods. (1) the next tabby shed may be opened and the tabby thrown from left to right across the entire width; or, (2) the same open work stitch may be woven, this time from left to right. In the latter case the left hand edge would be built-up first by the customary three treadlings. The details of this second method are as follows:

From the left edge, insert shuttle in the next tabby shed for 78 warp ends, or to a point above the last hole of row one, and bring shuttle up through top of warp ends.

Change shed and return shuttle to left edge.

Change shed and return shuttle under the 78 warp ends plus 4 ends more; beat with shuttle and pat this first unit down.

Change shed and return for the 4 warp ends.

Change shed and go forward 8 warp ends, stopping the shuttle on its way through to pat down the first unit before going on through the second unit.

Continue the above for the 13 pattern units, then build up the central tabby area with its three treadlings, proceed to the next 13 pattern units on the row, and last fill in the three treadlings necessary to build up the tabby area to the right hand edge.

In a like manner, proceed to the second row of Plate B, in which only two openings appear, and so on throughout the entire design.

Once the beginning of the design is made, counting is greatly simplified for the balance of the design area.

The Spanish Open Work stitch is often used simply as a

band across the woven piece, - a "hemstitched" effect. A number of the common variations are noted and some are sketched below:

1. Pattern weft travels in the same direction for each row of open work:

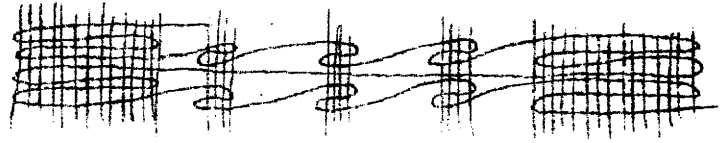

2. Open work stitch woven in first one direction and then the other:



3. Three rows of open work stitch, centre row being made up by dividing the original groups to form new groups, - a staggered effect:

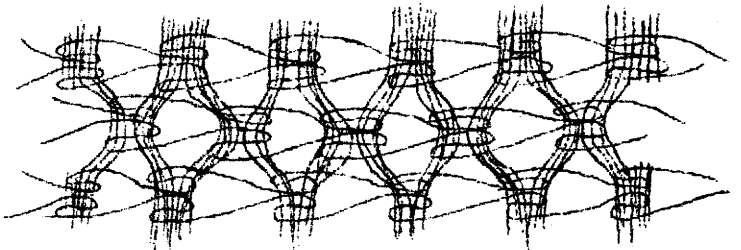

4. Where a very open effect is desired, edges are built up forward and back for as much as $\frac{1}{2}$ " to 1" between rows of open work. (use extra end of weft at right edge for build-up):

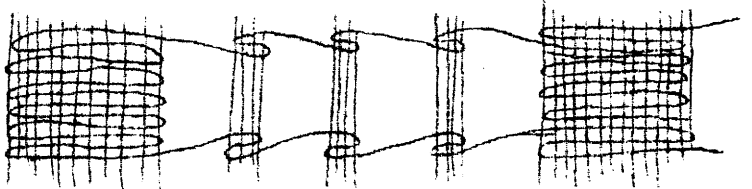

5. More than three changes of weft may be made in each area, e.g. 5 changes:

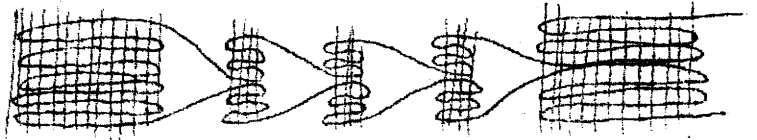

6. For a more intricate effect, a design may be worked in tabby against the open work background. These are illustrated in both the books previously mentioned: Allen and Stapley.

7. If, instead of the basic twill threading, the warp is threaded into a Goose Eye or Huck, these weaves may be combined into the article being woven.

Here, again, we have a weave which gives the weaver great latitude in working out his or her own designs, and we hope many of you will take advantage of such an opportunity for individual work. In adapting designs from various sources, and in planning one's own, it should be kept in mind that each unit drawn on the squared paper requires 8 ends of warp, 4 up and 4 down, and on this account the woven effect is larger than one might imagine.

GOOD WEAVING!

Mary Sandlin
Ethel Henderson

DESIGNS FOR SPANISH OPEN WORK WEAVE
(adapted from Stitchcraft)

1 unit of pattern represents 8 warp ends

```

XXXXXXXXXXXXXXXXXXXXXXXXXXXXXXXXXXXXXXXXXXXXXXXXXXXXXXXXXXXXXXXXXXXX
X
X
X X X X XXXXX XXXXXXXXXXXX XXXXXX X X X X
X X X X X X X X X X X X X X X X X X X
X X X X X X X X X X X X X X X X X X X
X X X X X X X X X X X X X X X X X X X
X X X X X X X X X X X X X X X X X X X
X X X X X X X X X X X X X X X X X X X
X X X X X X X X X X X X X X X X X X X
X XXXXXXXXX XXXXX X X XXXXX XXXXXXXXXXXX X
X
X
XXXXXXXXXXXXXXXXXXXXXXXXXXXXXXXXXXXXXXXXXXXXXXXXXXXXXXXXXXXXXXXXXXXX

```

PLATE A, - Band for Tea Cloth

```

X
X
X
X
X X XXXXXXXXXXXXXXXXXXXXXXXXXXXXXXXXXXXXXXXXXXXXXXXXXXXXXXX X X
X X XXX XXX X X
X X XXX XXX X X
X X X X X X
X X XXXXX XXXXX XXXXX X X
X XXXXXX XXXXX XXXXX XXXXXX X
X XXXXX XXXXX XXXXX X
X XXXXX XXXXX XXXXX X
XXXXXXXXXXXXXXXXXXXX XXXXXXXXXXXXXXXXXXXXXXX
X X
X X
X X
X X XXXXXXXXXXXXXXXXXXXXXXXXXXXXXXX X X
X X XXX XXX X X
X X XXX XXX X X
X X X X
X X X X
X XXXXXX XXXXXX X
X X
X X
XXXXXXXXXXXXXXXXXXXX XXXXXXXXXXXXXXXXXXXXXXX

```

PLATE B, - Border for runner, etc.

(Note: The effect of the spacing on the typewriter gives an elongated appearance to the motif, - elongated by one-third)

DESIGNS FOR SPANISH OPEN WORK - Continued

```

XX  XXXXXXXXXXXXXXXXXXXXXXXXXXXXXXXX  XXXXXXXXXXXX
XX  XXXXXXXXXXXXXXXXXXXXXXXXXXXXXXXX  XXXXXXXXXXXX
XX  XX                                XX  XX    XX
XX  XX                                XX  XX    XX
XX  XX                                XX  XX    XX
XX  XX                                XX  XX    XX
XX  XXXXXXXXXXXXX                    XX  XX    XX
XX  XXXXXXXXXXXXX                    XX  XX    XX
                                XX  XX    XX
                                XX  XX    XX
XXXXXXXXXXXXXXXXXXXX                    XX  XX    XX
XXXXXXXXXXXXXXXXXXXX                    XX  XX    XX
XX  XXXXXXXXXXXXXXXXXXXXXXXXXXXXXXXX  XX
XX  XXXXXXXXXXXXXXXXXXXXXXXXXXXXXXXX  XX
XX  XX                                XX  XX    XX
XX  XX                                XX  XX    XX
XXXXXXXXXXXXXXXXXXXX                    XX  XX    XX
XXXXXXXXXXXXXXXXXXXX                    XX  XX    XX
                                XX  XX    XX
                                XX  XX    XX
                                XX  XX    XX
XXXXXXXXXXXXXXXXXXXX                    XX  XX    XX
XXXXXXXXXXXXXXXXXXXX                    XX  XX    XX
XX  XX                                XX  XX    XX
XX  XX                                XX  XX    XX
XX  XX                                XX  XX    XXXXXXXXXXXXXXXX
XX  XX                                XX  XX    XXXXXXXXXXXXXXXX
XX  XX                                XX  XX    XX
XX  XX                                XX  XX    XX
XX  XXXXXXXXXXXXXXXXXXXXXXXXXXXXXXXX  XX
XX  XXXXXXXXXXXXXXXXXXXXXXXXXXXXXXXX  XX
XX  XX  XX                                XXXXXXXXXXXXXXXX
XX  XX  XX                                XXXXXXXXXXXXXXXX
XX  XX  XX                                XX
XX  XX  XX                                XX
XX  XX  XX                                XXXXXXXXXXXXX  XX
XX  XX  XX                                XXXXXXXXXXXXX  XX
XX  XX  XX                                XX  XX
XX  XX  XX                                XX  XX
XX  XX  XX                                XX  XX
XX  XX  XX                                XX  XX
XXXXXXXXXXXXXXXXXXXX                    XXXXXXXXXXXXXXXX  XX
XXXXXXXXXXXXXXXXXXXX                    XXXXXXXXXXXXXXXX  XX

```

PLATE C, - Corner for Lunch Cloth (when worked out on squared paper and on the loom, corner should be square).

```

XXXXXX  XX  XXXXXX  XX  XXXXXX
XXXXXX  XX  XXXXXX  XX  XXXXXX
  XX  XX  XX  XX  XX  XX  XX  XX  XX
  XX  XX  XX  XX  XX  XX  XX  XX  XX
  XX  XXXXXX  XX  XXXXXX  XX
  XX  XXXXXX  XX  XXXXXX  XX

```

PLATE D, - Border for Towel End.

LOOM
MUSIC

VOLUME II

NUMBER 8

AUGUST, 1945

Mary
Sandin
Edmonton

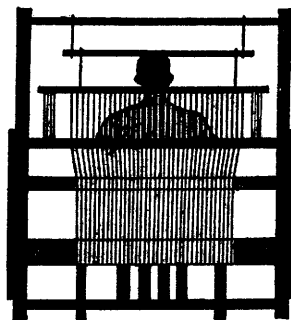

Ethel
Henderson
Winnipeg

L O O M M U S I C

Volume II, Number 8

August, 1945

TWO-HARNESS TECHNIQUES, SUITED TO THE
BOX LOOM WITH RIGID HEDDLE

We who use large looms constantly are often inclined to scoff a little at lesser equipment. However, the rigid heddle type of weaving has a very definite place in the weaving family, -- for therapy, school room, and youth project activities. We prefer to use a box frame for our school room work, although there are other types in use, including small looms with rollers. For little fingers, however, fewer difficulties are encountered with the box frame.

This type of loom is widely used in both the school room and the military hospital in England. The heddle itself is very ancient, -- of Scandinavian origin. In its use there, no frame was necessary: one end of the warp was fastened to a door post or hook, and the other end around the weaver's waist. Variations of this type of heddle are found in many primitive communities. There are several excellent text books for this type of weaving, published both in England and on this continent. First, the book references:

Easy Ways of Weaving, by Agnes Miall, Pub.: Women's Magazine, Bouverie St., London, Eng., about \$1.00.
Easy Weaving, by Elsie Mochrie, Pub.: Driad Handicrafts, Leicester, England.
First Steps in Weaving, by Ella Victoria Dobbs, Pub.: The Macmillan Co., Toronto, \$1.00.

These books also give weaving on cardboard frames, and graded exercises for various ages. We are appending a line drawing of a small box loom and a home-made heddle, since

commercial heddles are off the market for the time being.

For weaving on these looms, worsted yarn, 3- or 4-ply, is recommended for first pieces. Carpet warp or 8/2 cotton may be used. However, cotton has little "give" to it, and is used more successfully on a loom with rollers, since some difficulty is encountered in moving the cotton warp around the box loom as work progresses. A way to overcome this is noted later in this article. With our school pupils, the first exercise is a belt, and we give several examples:

BELTS

Belt No. 1: Warp of several colors of 3- or 4-ply worsted yarn, weft one color of the same yarn. Use strong secondary colors: yellow, red, green, blue; and black. A one-ounce ball of each color makes about 20 belts, 1½" wide finished.

The warp consists of 4 ends of each color except yellow (2 of this color), arranged as follows: 2 black, 2 red, 2 green, 2 blue, 2 yellow, 2 blue, 2 green, 2 red, 2 black.

SEE PLATES II AND III, pages 76 and 77, for the method of WARPING AND THREADING the rigid heddle loom.

For weft, wind about ten yards double on the shuttle, using red or yellow or green.

Begin to weave 12" from knots, turning end in as shown on Plate III, page 77. Weave 24" to 30", and turn the last end in. The belt is moved toward the weaver, under the loom, as weaving progresses. During the weaving, keep the weft beaten evenly with each weft shot at right angles to the warp ends, the edges straight, the turnings neat, and the width of the belt uniform. To remove belt from loom, untie warp ends one by one, - a large darning needle through the knot will pull it right out.

To finish Belt No. 1: Have ready 6 large wooden beads

with large holes. Divide ends of warp into three equal parts and thread each group through a bead, knotting beyond the bead to hold the bead firmly against the weaving. Leave long tassels and cut to even length. To fasten at waist, tie tassels in square knots, letting the ends hang down.

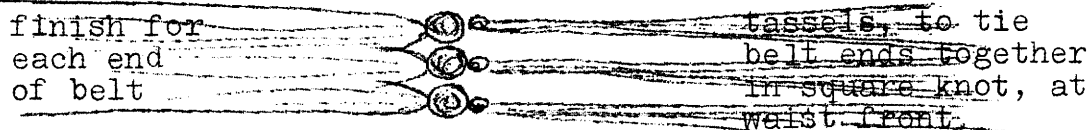

Belt No. 2: Two Colors of Warp, as turquoise and white, or red and white "Strawcraft" (obtainable at Eaton's at 45¢ per skein), 1 skein of each color ($\frac{1}{2}$ skein is sufficient for one belt). Weft: Either of above colors in the same material.

Warp arrangement: 2 ends of each color, alternating, with the outside edges alike: 36 ends in all for a belt about $1\frac{1}{2}$ " wide. The edge warp color is usually used as weft color, for a neater woven edge. When woven over in one color, crosswise stripes are obtained. Begin the weaving 12" from the knots.

Belt No. 3. Warp: Carpet warp in one color, e.g. yellow, 26 ends. Weft: $12/4$ mop cotton in henna on one shuttle, $8/2$ cotton in leaf green on a second shuttle. (1 skein of each makes many belts). Weave heavy cotton on the "down" shed, light weight cotton on the "up" shed. A squared surface will result, which may be cross-stitched in coarse yarn before cutting off the loom, to give a surface design. Begin weaving 12" from knots.

SCARVES

The warping and tying of scarves is identical with belts. We will give three scarf set-ups:

Scarf No. 1: Light weight scarf, plain basket-type weave. The point to be noted here is the choice of yarn. We recommend a $2/16$ "Weavcraft" (Searle Grain Co., \$2.85 per lb. of 3500 yds.)

One scarf uses approximately 800 to 850 yards, so one pound will make four scarves. This yarn is used double in the warp and woven double, that is, two warp ends are used together in each eye and in each space of the heddle, and the weft is put on the shuttle double. To do this, wind off an extra ball, then wind

Winding
Shuttle
Double

weft from cop and extra ball onto shuttle simultaneously.

Set up scarf 12" wide, tie warp firmly, but not too tightly. Begin weaving $1\frac{1}{2}$ " from knots. The end of the weft thread should be taken around the edge warp end, and back into the same shed for 1". This procedure applies to all joinings, and endings as well. Hanging ends are later clipped flush with the weaving. (See Plate III, p.77)

Joins,
and
Beginning
and
Ending
Weft

As weaving progresses, see that edges are neatly turned. If weft is pulled too taut, the warp will draw in and narrow, interfering with proper beating. Loops also are unsightly, therefore care must be taken to keep a good edge.

Edges

To beat, place hands at sides of heddle and bring it back at exact parallel to bar of loom; press lightly to straighten weft. Result should be a square mesh, with a little "daylight" showing.

Beating

When as much as is convenient has been woven, release front bar, bring warp back with the heddle. Replace bar and check straightness. If warp has been tied too tightly, there will be spreading of weft at bar and this will spoil the work. Continue weaving and moving warp over until the knots interfere with further weaving.

Moving
Warp

The ends may be "overcast" while the scarf is still on the loom, or a knotted fringe may be tied after removal. To remove scarf from loom, the warp end knots

Finishing

are untied one by one, - a large darning needle through the knot will pull it right out, and the ends serve as fringes.

Knotting Knotting neatly and against the edge of the weaving is done as follows:

1. Place scarf on a flat surface with a weight on the scarf near its end.
2. Pick up 4 ends of fringe on the left hand side. Holding these ends between the thumb and forefinger of the right hand, twist them to the left from the end until the four ends form one strand.
3. With the end of twist still in right hand, hold centre of twist in left hand and bring end over above the left hand and under through the resulting loop.
4. Transfer end to left hand, and with the right hand grasp the loop and slide it up against the edge of the weaving.
5. With the thumb and forefinger of the left hand holding this loop firmly against the weaving at point X, pull down on the end Y with the right hand, drawing knot tight.

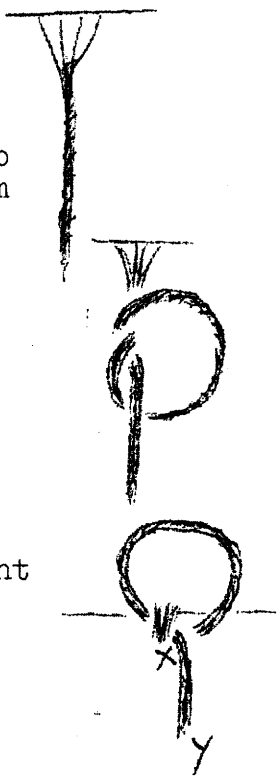

Scarf No. 2: Suitable for men, - the design resembles "Hound's Tooth". Warp: With 4-ply yarn in two colors (2, 1-oz. balls of each), as black and white, brown and yellow, etc., warp the required number of ends, half of each color. Tie 2 ends of each color alternately across the width. Weaving: Use 2 shuttles, one with each color, and weave 2 rows of each alternately. Carry weft ends along the edges. By beginning one color at each side of the scarf, both colors will not be carried along the same side.

Scarf No. 3: Large checks. Three colors in 3-or 4-ply yarn (1, 1-oz. ball of each), in harmonizing hues, e.g. (a) three blues, or (b) cerise, wine, and cyclamen, or (c) cream, beige, and brown; also a few yards of a contrasting color, e.g., with (a) use

yellow, with (b) use light green, with (c) use medium blue. Warp: Measure off about 48 ends of each of the three major colors and 7 ends of contrast. For example (c), thread the loom with 1 end blue, 24 ends cream, 1 end blue, 24 ends beige, 1 end blue, 24 ends brown, and repeat, ending with 1 end of blue. Weaving: Weave each color of the three in turn, "squaring" each color area. In changing colors, make turn-ins short and neat.

Scarf No. 4: Weft Stripes. Set up loom with 4-ply yarn in soft green, about 125 warp ends; weft the same (3 balls in all), with contrasting colors at each end, to weave in interesting stripe arrangements. We suggest that the stripes be of different widths, planned out previously on paper of actual size and suitably colored, to get the effect of proportion.

COTTON PLACE PIECES

Cotton is somewhat more difficult to use for this type of work than yarn, because cotton has little "give" or stretch. Consequently, if tied too tightly it cannot be moved around the loom readily. A good idea is to have a smooth piece of wood about 12" x 1" x $\frac{1}{2}$ ", to place across the front of the loom and tie warp around loom and stick. This stick can be withdrawn when warp is moved and put back after moving, to retain the tension. We cannot use a fine warp, as the heddle eyes and spaces are not suitable, and so recommend a carpet warp, or 8/2 cotton used double. Usually 1 set-up makes two 18" mats, with or without fringe. The 8/2 cotton is sold in $\frac{1}{2}$ -lb. cops of 1600 yards each, at approximately 65¢ per cop. To set up loom once to the full width of the heddle (12"), requires about 144 double ends $1\frac{1}{2}$ yards long plus extra for tying, or about $\frac{1}{4}$ lb. for both warp and weft. Carpet warp would require approximately the same weight, since it would be used single for warp and weft. The loom is threaded and tied up just

as for scarves, and we suggest below several types of weaving for place pieces.

No. 1: Gauze Weave bands on Place Pieces: With weft of the same material as the warp, weave about 3 inches plain weaving, usually called "tabby", ending on shed A. Push heddle to back of loom and depress it (Shed B), and insert a ruler edgewise to keep shed open. Have shuttle at right hand side of loom, and begin the gauze stitch on the right, -- the stitch twists two warp ends together. You will need a long narrow stick for picking up warp ends, $\frac{1}{2}$ " x $\frac{1}{2}$ " x 14", smoothed well. Hold this stick in the right hand in a horizontal position at the right edge of the warp. Push the tip of the stick over the first upper thread, which now becomes a lower thread. With the left hand, pull up the first warp end from the lower group (at the right side of the loom), bringing it up to the left of the first upper thread and over the pick-up stick. Continue across the warp. Then turn pick-up stick on its side and pass the shuttle through its shed. Remove pick-up stick and ruler and pass shuttle back using the opposite shed (A); no pick-up is necessary. Pick up again on Shed B as before, and weave back plain on shed A. Rule: Picking up is done only on B shed, -- A

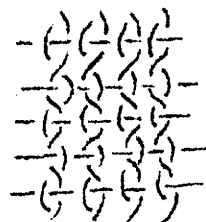

detail of gauze weave

shed is woven plain. Do three such bands at this end of the mat, beating the weft shots back so that uniform rows of open work are formed. If the beating is too tight at this point, much of the open effect is lost, and if too loose the band will appear "sleazy".

Then weave tabby for about 12", repeat the gauze weave bands for the other end, then 3" tabby. Hem with a one-inch hem.

No. 2: Danish Open Work bands on Place Pieces: Set-up is

the same as for previous mats. With weft the same as the warp, weave 3" of tabby weave, ending with shuttle at left side of loom. Then take a length of several yards of a contrasting color and thread it into a large darning needle. If tabby ended on shed B, run color across once on shed A, from right to left, and turn in beginning end. Leave needle end hanging at left side of loom, and, using the shuttle again, weave 6 tabby shots, letting shuttle rest at left. With needle and using the next shed, enter shed from left to right for 1" forward and bring the needle out on top of the weaving. Take needle towards you over the weaving to first line of color and insert it in the weaving to include this colored thread, making sure that the needle is inserted between the same warp ends at this point as it was brought up between above. Carry the needle back from you under the weaving to the present line, coming up to the left of the colored weft as in making a blanket stitch, thus:

Pull end fairly tight to make a scallop, but at the same time avoid drawing in the edges of the

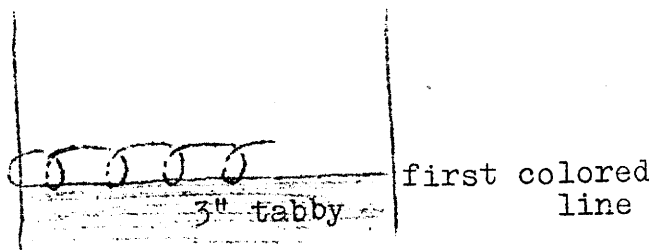

weaving. Continue across, making stitches 1" apart all the way, and let needle rest at right. Weave 4 shots of tabby with shuttle. Pick up color and weave across one shot on the next shed, letting needle rest at left. With shuttle, weave 6 shots of tabby. With needle repeat former process, except to make entering stitch only $\frac{1}{2}$ " from the edge, and at 1" intervals thereafter, to stagger these stitches with those in the first row. Weave 4 rows of tabby, then repeat first row of color, then 6 rows of tabby, then first row of colored stitches, ending off the colored thread.

Weave 12" tabby for centre, repeat three rows of Danish Open Work, then 3" tabby for border and hem. Hem with a 1" hem.

No. 3: Brocade Decor on Place Pieces: A brocade is a "pick-up" over and under, across the weaving with the shed closed, with a tabby shot following each design thread to tie it down. The design is planned out on graph paper and transferred line by line to the loom. Any block pattern border may be thus used, showing in reverse on the under side. There is one caution: do not have pattern skips or spaces between them too long, or they are impractical when woven.

For place pieces we suggest warping the loom to the full 12" width, using carpet warp singly as warp and weft, in beige or turquoise or pale green or yellow, with white 12/4 or mop cotton or candlewick cotton for design bands. (12/4 in $\frac{1}{2}$ -lb. cops from Searle Grain Co., Winnipeg, at about 65¢ per cop).

With weft like the warp, weave 3" tabby, ending on tabby B. Then begin white pattern band, following the simple pattern below:

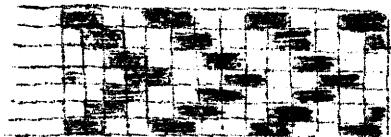

With a pick-up stick, working from the right hand edge, with no shed open, pick up the warp threads in accordance with the design above: miss 2 warp ends, pick up 2 warp ends, all the way across the warp. Turn stick onto its side and pass white 12/4 on shuttle through this shed. Throw A tabby.

Pick up next row on graph: miss 1, pick up 2, miss 2, pick up 2, etc., and throw white pattern. Tabby B. Continue for the 7 white design rows, and end off the white thread.

Weave a tabby centre of about 12", repeat design band, repeat 3" of tabby for end border and hem, finish with a one-inch hem.

All the above table pieces should be machine stitched

Finishing
Place
Pieces

at the ends when taken from the loom to prevent fraying. Run two rows of stitching about $\frac{1}{4}$ " apart between pieces, before cutting them apart. Hide the stitching in the hem's first turn-in, and hem the mats with hand-hemming stitches.

While all the above projects have been described for use on the "box" or "rigid heddle" loom, they can of course be used on other simple type looms, and on your regular 4-harness looms as well. You may have already a cotton warp on your loom, any threading at all, on which you will wish to try out the three types of place piece described above.

Good weaving!

Ethel Henderson

Mrs. E. M. Henderson
20 Ritz Apartments
Winnipeg, Manitoba

Mary Sandin

Mrs. R. B. Sandin
c/o University of Alberta
Edmonton, Alberta

One of our Canadian weavers writes that she has a loom for sale, which she described to us as follows: "An 8-harness floor loom, remodeled from a 4-harness LeClerc 45" loom, complete with 8 frames, 2500 metal heddles and 10 treadles; 49" deep, 48" wide", and which she will sell for \$85.00. Anyone interested should write to Mrs. A. Finestone, 5609 Canterbury Ave., Montreal, Quebec.

Per Year \$3.00

Copyright 1945

PLATE I

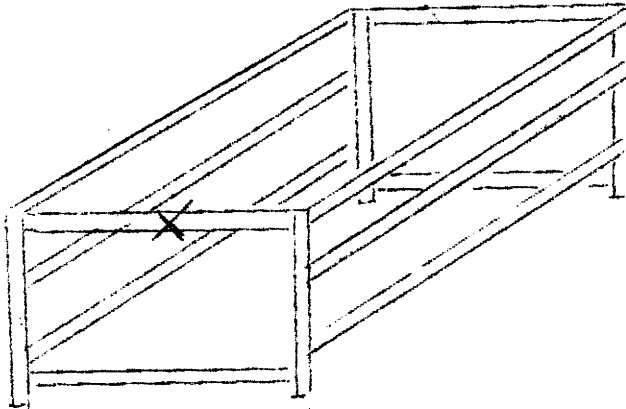

Frame should be well braced, with bar at X removable.

Frame for "box" or "rigid heddle" loom

*holes & slots
10 to 12
per
inch*

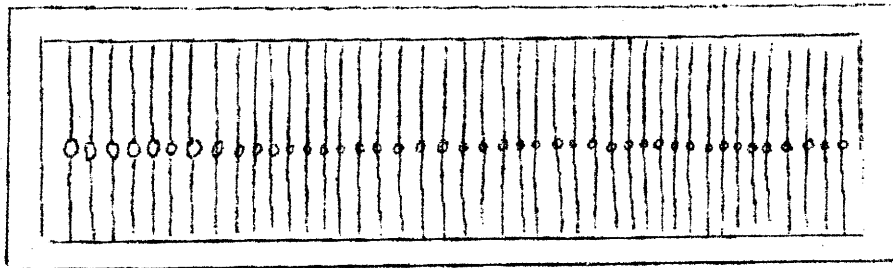

Heddle, - Wire Type: Wires are twisted with hole at centre and fastened to plywood frame, or soldered into a double-faced metal frame.

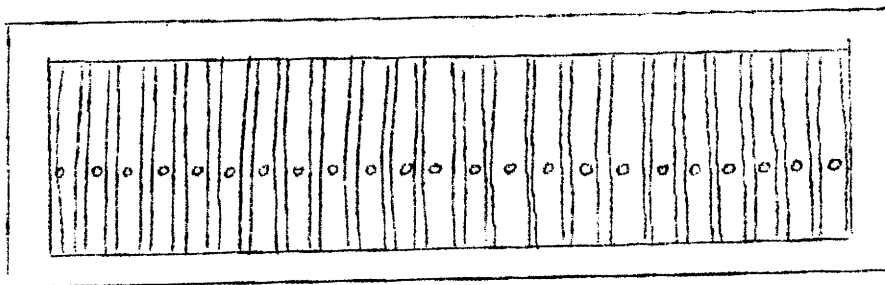

Heddle, - Solid Type: Stamped from sheet aluminum or chrome steel. (Formerly obtained from Driad Handicrafts, Leicester, England).

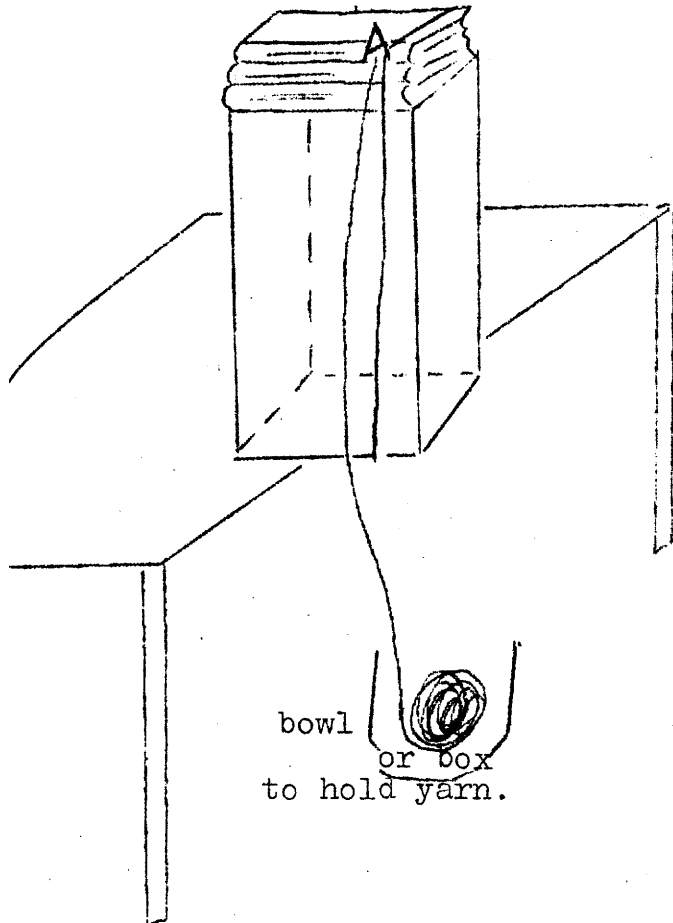
PLATE IIWinding and Measuring Warp

1. Place loom upright on table, projecting about 3" over the table's edge.
2. Place 3 books on top, - to give extra length for tying ends.
3. Place end of yarn at point A, and bring it around loom to A again = 1 warp end. Continue winding warp around until the required number of ends is obtained. Cut through warp at point A. Keep cut ends around one's neck for convenience.

Threading the Loom

1. Tie one warp end at each side to support heddle.
2. Thread next warp end through the slit between heddle eyes, carry it around the framework, then tie it above bar "X" (see tie on next page).
3. Then thread next end through the next heddle eye, pass it around the box and tie.

Continue for entire warp, keeping the tension uniform throughout.

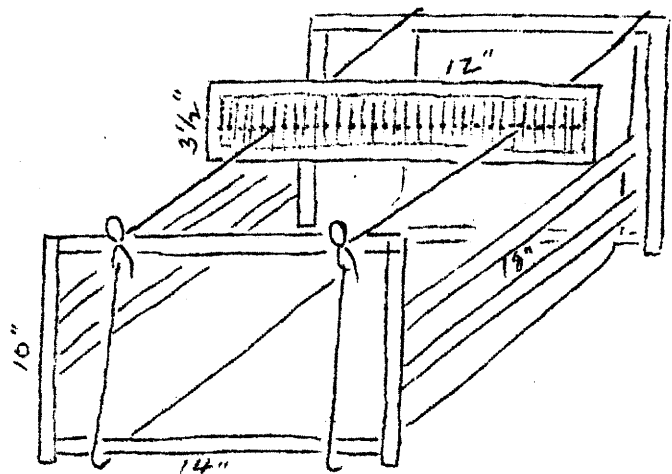

front of loom

PLATE III

"Tie" for warp ends, above front bar:

1. First a slip knot

2. Then a half bow knot

3. Then another slip knot, using the long end A and the bow C.

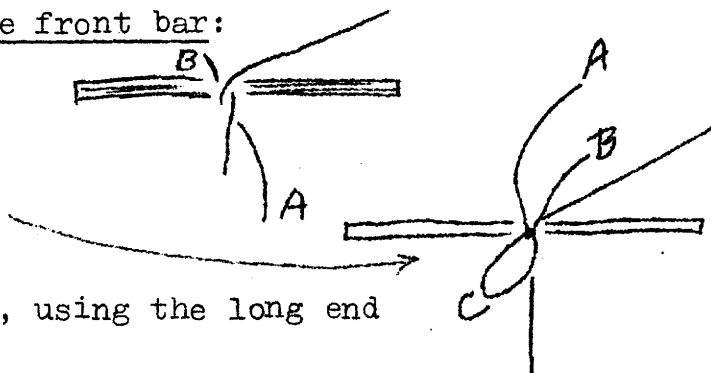

Side View of Loom showing Sheds

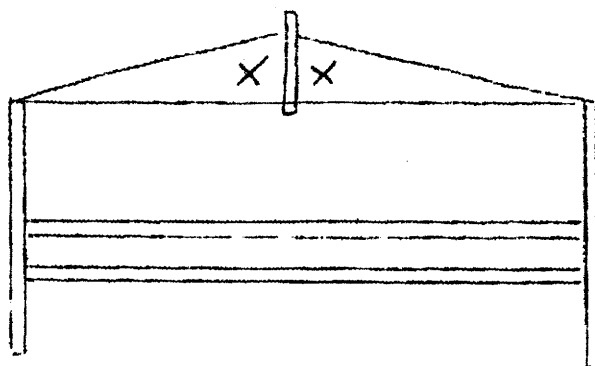

Heddle lifted
Space x x = Shed A

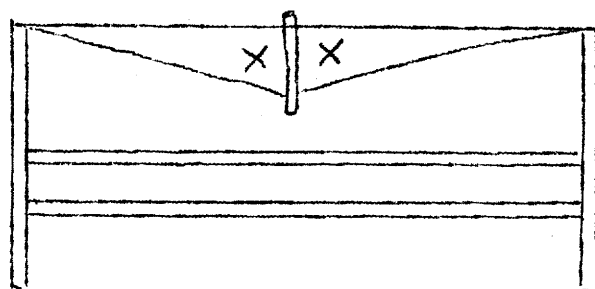

Heddle depressed
Space x x = Shed B

Detail of Plain or Tabby Weave,
showing beginning and ending of weft threads

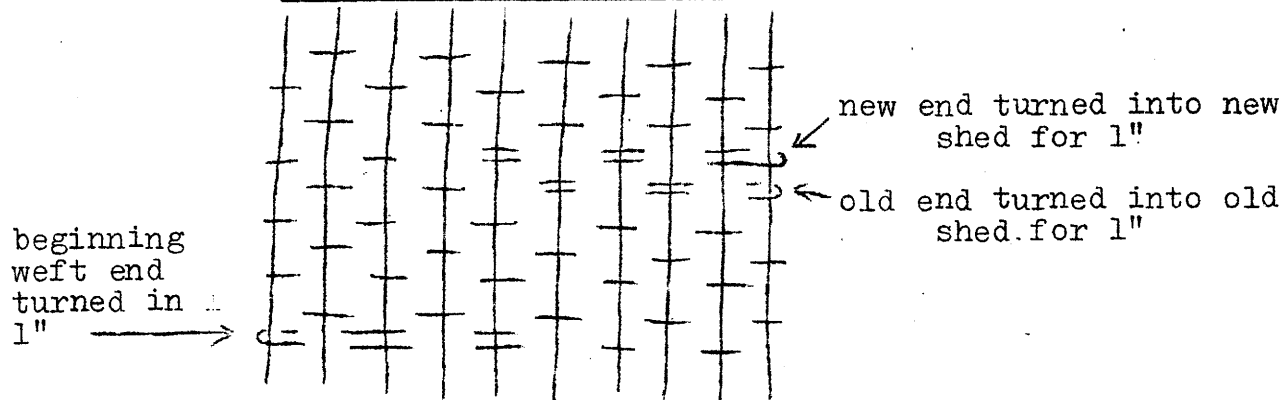

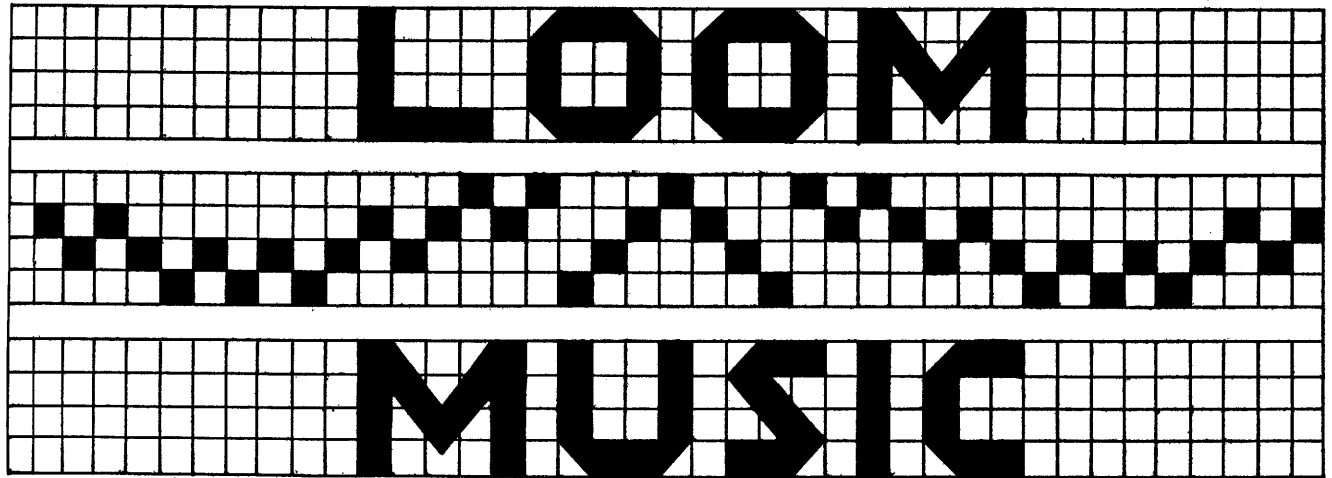

VOLUME II

NUMBER 9

SEPTEMBER, 1945

*Mary
Sandin*
Edmonton

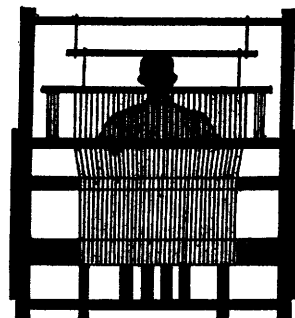

*Ethel
Henderson*
Winnipeg

L O O M M U S I C

Volume II, Number 9

September, 1945

"OLD COUNTRY" WOVEN BAGS

The great migration of people from Central and Southern Europe in the early decades of this century has given to our Canadian scene definite contributions in the fields of music, craft, and good citizenship in countless instances. This is particularly evident in Winnipeg, where a large Ukrainian population is grouped in an urban setting. It is also evident in the many rural districts of the prairie provinces where citizens of European extraction are found. We mention one in particular, Vegreville, east of Edmonton. In the rural districts these groups assimilate into the Canadian scene more slowly than in the cities.

Twenty years ago one could motor from Winnipeg to Selkirk, a distance of twenty miles, past small farms dotted with the whitewashed, square-cut log cabins of these people. The doors and windows of these cabins were invariably trimmed with a bright blue known as the "blue of the Virgin Mary". The largest buildings to be found were the Greek Orthodox churches with their oriental domes and minarets. Today a drive through the same section reveals hardly a log house; instead we see comfortable homes of modern construction facing the busy highway. The only familiar buildings left are the churches.

It is in the craft work of these people, Ukrainian, Polish, Roumanian, and many others, that we find great interest,

and it is a matter of regret that the generation born in Canada has little or no time to preserve the craft skill, or so it seems.

One of us has taught for a number of years in a school where many of the pupils are and have been of Ukrainian and Polish parentage, and has found that the mothers and many of the fathers, and the grandparents, have been weavers in the "Old Country". When the journey to Canada was made, looms were left behind, and in the struggle for economic security in this country the craft had been lain aside.

In this school we have had many examples of the lovely cross-stitch embroidery, trimming the blouses which are worn with the colorful national dress, and which are indigenous to the district from which they have come in the old land. A great many of these beautiful embroideries have been preserved and adapted to modern use in table settings of the finest linen by Mrs. Frances Lount of Winnipeg. She is also the designer of the now famous and admired motif of "Wheat", embroidered by these same Ukrainian needlewomen. For these embroideries no design is stamped, but the threads of linen are painstakingly counted and the design itself copied from the printed page. In a small store near our school these designs are found on post cards. The embroidery done for the Canadian Handicrafts Guild is done on "bisso" linen, and D.M.C. embroidery thread is used.

Often a child, learning to weave on the rigid heddle "box loom" or on the old two-pedal foot loom we possess at school, shyly proffers, "My mother used to weave in Old Country". Then, if one follows this up, the weaving is forthcoming, carefully preserved and not in common use: handspun and woven coarse bleached linen in damask patterns, rugs and blankets of homespun,

and the Sunday belts in intricate design. These are kept in the trunk and no amount of pleading will coax them away permanently from the owner.

A few years ago we were taken to see a loom constructed by a weaver, a man from the "Old Country". It was a revelation! In size it was about 6 feet wide and 7 feet deep, and at least 6 feet high. The beams were logs about 8" or 9" in diameter, and the ratchets were also carved from wood. There was not a timber in it less than 4" x 4", an overhead batten, and a built-in bench. The heddles were continuous, and seemed to be made of heavy waxed linen in an arrangement between two horizontal sticks, but this is just our impression after a long time has elapsed. This loom was also equipped with a fly shuttle, and was warped with carpet warp to weave off rag rugs.

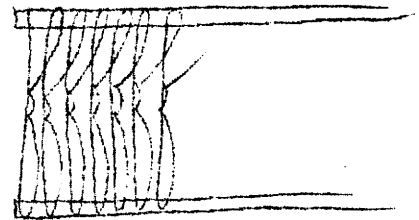

It is from a home made loom somewhat the same as this one, except for the fly shuttle, that comes the weaving we describe to you this month. This weaving is by Ukrainian and Roumanian workers, and has been adapted to our use from the old wall hangings found in many of their Canadian homes and churches. These particular pieces come from east of Edmonton.

The rugs or hangings were generally dyed homespun on a linen warp, done in a "Kelim" technique in the pattern areas, which areas were separated by bands of stripes. The dyes were originally vegetable. Now many commercial dyes are used, but the lovely reds come mostly from beets. The Roumanian homes are said to have one wall, we were told the north one, that has no doors or windows, and these rugs are hung just below the eaves on this wall.

Details of the Bags

The stripe arrangements have been taken from the rugs and doubled over to make tremendously colorful utility work bags. They require no lining, are practically indestructable, and are striking in appearance. The homespun used in them is spun on a hand spindle, to give a coarse quality. The bags we describe have been in constant use for years and are still fresh and new appearing. The colors are decidedly "foreign", but harmonious, although they may not so sound.

Bag No. 1, - Miss Bradshaw's Bag

No. 1 is a bag in which the dominant colors are black of the natural very dark brown fleece, white, and a grand raspberry shade. The homespun is very coarse, the fabric stiff and harsh feeling.

Colors required are: Natural black, white, raspberry, small quantities of jade green, gold, true red, bronzy orange, wine, and lilac, all homespun.

The warp is coarse linen, set at 8 ends per inch, 24 to 26" wide in the reed, in a twill threading:

		x	x		x		4
	x	x				x	3
x	x				x		2
x			x			x	1
1	2	3	4	5	6		

tabby

Tie-up

Begin								
	4		4		4		4	4
	3		3		3		3	3
	2		2		2		2	2
1	1		1		1		1	1

Threading

The weft covers the warp completely, and as a consequence plenty of slack should be allowed in each weft shot. The bag was doubled so that the stripes run vertically, and the handles were of the black yarn, twisted as one makes a skein. We call it Miss Bradshaw's bag, - it is Roumanian

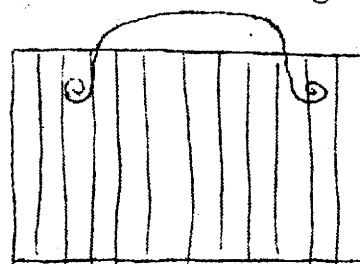

weaving, we are reliably informed.

The Weaving, Bag No. 1:

Weave in tabby:

$\frac{1}{2}$ " linen, like warp, for side seam turn-in.
 $\frac{1}{2}$ " red
 2 shots natural black
 1 shot white, picked up over 3 and under 3, all
 across the warp, with the shed closed
 2 shots black
 1 shot white, over 3 and under 3
 $\frac{1}{2}$ " natural black
 2 shots white
 1 shot black
 $\frac{1}{2}$ " white
 1 shot black
 2 shots white
 $\frac{1}{2}$ " black
 2 shots white
 2 shots black
 $\frac{1}{2}$ " white
 2 shots black
 2 shots white
 $\frac{1}{2}$ " black
 1 shot white, over 3 and under 3
 2 shots black
 1 shot white, over 3 and under 3
 2 shots black
 $\frac{1}{2}$ " raspberry
 2 shots black
 2 shots white
 1 shot gold
 1 shot jade green, over 3 and under 3
 1 shot gold
 1 shot jade green, over 3 and under 3
 1 shot gold
 1 shot jade green, over 3 and under 3
 1 shot gold
 2 shots black
 2 shots white
 2 shots black
 $\frac{1}{2}$ " raspberry
 1 shot black
 1 shot white, over 3 and under 3
 1 shot black
 1 shot white, over 3 and under 3
 1 shot black
 2 shots wine
 $\frac{1}{2}$ " bronzy orange
 2 shots wine
 $\frac{1}{2}$ " pale lilac -- This is the centre, and the
 weaving is reversed from the lilac.

BAG NO. 2 is an arrangement from a rug from the same district, but woven in Europe.

The warp here was brown linen, about a 1/18, set at 9 ends per inch. In lieu of linen, use carpet warp of a heavy grist, 24 to 26" wide in the reed. The same twill threading is used, and the weaving is done in tabby as before, so that the warp is completely covered.

Colors are: natural brown, white, red violet, violet, spring green, green gold, black, a cerise beet red, and a bronzy orange, all homespun.

The Weaving, Bag No. 2:

Weave in tabby:

$\frac{1}{2}$ " linen, like warp, for side seam turn-in
 $1\frac{1}{2}$ " natural black
 $\frac{1}{2}$ " white
 $1\frac{1}{3}$ " red violet
 $\frac{1}{2}$ " spring green
 $1\frac{1}{3}$ " red violet
 $\frac{1}{4}$ " violet
 3 shots black
 1 shot beet red, picked up over 3 and under 3, all across the warp, with the shed closed
 1 shot spring green, 3 over and 3 under, picking up threads alternate to the red above
 3 shots black
 $\frac{1}{4}$ " white
 $\frac{1}{4}$ " violet
 $\frac{1}{4}$ " red violet
 $\frac{1}{2}$ " bronzy orange
 3 shots black
 6 shots, black and white alternately, using treadles 1 and 3 alternately (harnesses 1-2 and 3-4)
 3 shots black
 1 shot red violet, over 3 and under 3
 2 shots black
 1 shot green gold, over 3 and under 3
 1 shot spring green, over 3 and under 3, picking up threads alternate to the gold above.
 REVERSE to the beginning, starting with the green gold shot, then weave
 $\frac{1}{2}$ " green gold, which is the centre of the bag.
 Weave the other half of the bag to match the above.

TO FINISH BAGS

Machine stitch the bags well before cutting. Fold across and sew up the side seams. Turn in a hem at the top, stitching by hand, and add handles. We have seen some of the bags with hand-loomed linen linings, inserted under the top hem,

but a lining is not essential.

In addition to the twisted yarn handles mentioned for bag No. 1, woven braid makes an excellent handle:

Make a 2-yard warp, 44 ends, using the following colors in warp-spun homespun:

- 4 ends black
- 4 ends white
- 2 ends red violet
- 2 ends violet
- 2 ends beet red
- 2 ends green
- 4 ends bronzy orange
- 4 ends green gold - centre, reverse, starting with the bronzy orange.

Thread in a twill threading, wind on, and remove the reed. With natural black on a belt shuttle, weave in a tabby weave, bringing the braid in to a 1" width. The weft should be hidden -- a warp face fabric -- and the edges neatly turned. Beat back firmly with the edge of the shuttle. After weaving, machine stitch before cutting the two handles apart, and attach them firmly to the bag, turning in the cut ends between lining, if used, and bag.

We know you will enjoy weaving these bags. They make excellent Christmas gifts, and are our this year's contribution to that cause.

Good weaving!

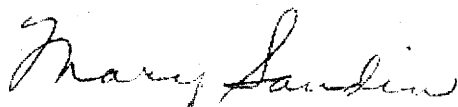

Mrs. R. B. Sandin
c/o University of Alberta
Edmonton, Alberta

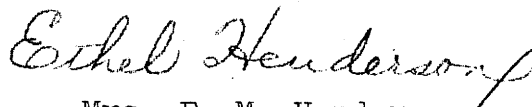

Mrs. E. M. Henderson
20 Ritz Apartments
Winnipeg, Manitoba

Per year \$3.00
single copy .35
Copyright 1945

LOOM
MUSIC

VOLUME II

NUMBER 10

OCTOBER, 1945

*Mary
Sandin*
Edmonton

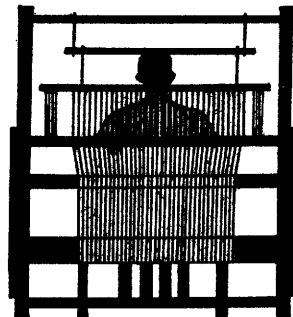

*Ethel
Henderson*
Winnipeg

BANFF: AUGUST 1945

It is eleven o'clock on Sunday morning. The carillon in the tiny English church is playing hymns, so that the sound of bells reaches our ears wherever we may be in this beautiful mountain valley. The air is clear and the sun bright; fleecy clouds dot the azure blue of the sky. A slight breeze ruffles the leaves of the poplars, and a squirrel chatters not far away. Our cabin (two tiny rooms) nestles at the foot of a lovely garden, and our garden chairs are the color of the scarlet geraniums in our window boxes. The outside platform at our front door is fringed with tall delphinium, and another row of them nearby is in constant motion with swarms of busy bees.

We "lift up our eyes unto the hills" and receive with thankfulness the message of the beauty of nature. To be working at our chosen work and to have such inspiring surroundings is a taste of what we imagine to be Heaven. This beautiful day is one of the rarest we have known.

Our school personnel is scattered to the four winds -- the artists are on the slopes sketching; a large group of others has gone to Lake Louise and to Moraine Lake, where they will hike and climb; some are swimming in the hot springs; and Mrs. Sandin, who re-creates through strenuous physical activity, has gone on a 40-mile jaunt on her bicycle to Lake Louise (she will take the evening train back to Banff!!). Dressed in slacks and a red plaid shirt, her red knapsack on her back, lunch time will find her

beside a mountain stream boiling water for coffee. As she is an experienced mountain-country person, this is one of her greatest pleasures. For our own part, we are content to stay in the garden, and to absorb the day in that fashion.

Our work at the Banff School of Fine Arts is most interesting this year. We have had many beginners and some old friends in our classes. At the time of writing, all the basic exercises in 4-harness overshot are over, our people have worked like Trojans at warping and threading the many projects planned for the session, our daily morning and afternoon lectures are in full swing, and for the next two weeks we plan a really pleasant session of weaving. We have some 20 floor looms and 8 table looms, all in constant use. Our warps are gay with color. We do count ourselves extremely fortunate in that we have an ample supply of bleached linen, colored cottons and yarns, both worsteds and homespuns. Our purchasing is done throughout the year as supplies become available.

You will be interested to know what we have set up, and will give a short description of some of the warps:

1. Upholstery for dining room chair seats. Warp: spring green 8/2 cotton; weft, greeny blue and rusty red heather homespun combined with a spidery red flecked cotton boucle -- on a Rosepath threading, woven in a diamond. This is a lovely piece, showing indistinct stripes with the change of colors in the weft.

2. Drapery, 36" wide, "Drifting Shadows", from Mrs. Atwater's Recipe Book; warp of carpet warp and gay colors for pattern and tabby.

3. A Swedish M's and O's arrangement, linen warp and weft, for place pieces.

4. A copy of an old Swedish cloth, with white 24/3 cotton warp, 36" wide, woven with a weft linen weft. This cloth

is so attractive that it will appear later as a bulletin.

5. A red 8/2 cotton, in a broken twill threading, 27" wide, for summer suiting or skirt material.

6. A white "Speedy" homespun warp, which we dressed with linseed solution, in a "dove eye" arrangement from Marguerite Davison. We have a choice of eight colors of weft to use on it, for jackets, and for hat and bag sets.

7. A baby blanket warp, pink and blue and white 3-ply baby yarn, in a 4-inch dornik arrangement.

8. Place pieces with a Summer and Winter draft arrangement, 24/3 warp and tabby, 16/2 yarn or 8/2 cotton for pattern weft.

9. Bath mats on the Periwinkle threading, warp and tabby of carpet warp, weft of heavy 12/4 cotton in white and pastels.

10. A coverlet, to be 90" by 108", using a 45" loom. The warp and tabby are white 24/3 Egyptian, the weft is 16/2 "Weavecraft" yarn in azure blue, to be used double on the shuttle. Drapes are to be woven to harmonize. The final planning for the drapes is not complete, but they will, of course, be treadled quite differently from the coverlet. We hope this, too, will be a bulletin of interest. Oh! yes, - the draft - a copy of the same square Swedish cloth we like so well -- you'll see it later in a photograph.

11. A guest towel warp, 24/3 natural Egyptian; the draft Series V, No. 4, Recipe Book of Mary M Atwater. We are using 16/2 pastel cottons as tabby weft, with contrasting pattern wefts; also a 40/3 Egyptian in turquoise which gives lovely texture!

12. An arrangement from a piece of Quebec "Catalogne" which, with others, will be the subject of our November bulletin. For this we used carpet warp in bright colors to make heavy

"peasant" type luncheon sets.

13. Our perennial favorite with all weavers, Mrs. Atwater's "Bronson" lace, in brown linen; with a white Cronita cotton warp ready to "tie on" when the brown is exhausted.

14. A "Leno" set up for scarves, in white 3-ply yarn.

15. An 8-harness damask, 24/3 Egyptian warp and linen weft.

16. We have several looms set up specially for "laid in" designs which are individually designed and worked out by each student. These are "required" weaving.

17. A 22" wide, deep blue and white Cronita cotton warp for the double weave. We use it to make bags and wall pieces.

18. A Rosepath setup for purses and "bound" weaving.

19. The bordered square which was the subject of the June, 1944, issue.

20. A lovely Whig Rose arrangement for runners.

21. An overshot design for the popular zipper top purses described in our June, 1945, bulletin, using 12/4 weft.

There are other looms set up with various exercises to provide skill for the student, also card weaving and Inkle belt weaving as a "must".

As usual, our students do not make samples, but usable articles. They designate their preferences, and take turns at the looms. We also have yardages of 16/2 "Weavecraft" and boucles on a yarn warp for individual weavings.

HANDWOVEN TIE LENGTHS

For your weaving of the month we are going to describe one of our most popular warps of the session, the one for men's ties. This year we have used a lovely brown 16/2 "Weavecraft"

warp set at 18 ends per inch, 27 inches wide. For ties, we always use a twill set-up and treadle them either plain or in "bones", as fancy dictates:

		X	X		X	4
	X	X				X
X	X				X	2
X			X		X	1
1	2	3	4	5	6	

Tie-up

Begin								
		4		4		4		4
	3		3		3		3	
2		2		2		2		2
1		1		1		1		1

Twill Threading Draft

Each student weaves about 40" in her individual pattern, worked out at the loom. For instance, "A" has woven: 2" brown, 1 line rosy red boucle, 2 lines red flecked greeny boucle, all in tabby; 4 shots azure blue 16/2 yarn in a twill; 4 shots flecked boucle, in tabby; 2 shots yellow 16/2 yarn in a twill, and so on, separating the color areas with 2" of brown 16/2 yarn in tabby weave.

"B" has woven a brown background, broken by narrow "bones" every 2", of 8 shots of azure blue yarn, - a quiet combination.

"C" has woven a little bit of every color and weight on hand, and has the gayest stripe arrangement ever -- the brown warp completely hidden.

"D" has woven over with scarlet 16/2 and stripes with yellow -- and so on.

Arrangements are endless and fascinating to work out. We must not forget to mention that the fabric is beaten up lightly so that the resulting web is light weight.

After finishing the tie web by a thorough steaming and pressing, the cutting out is done. One gets three ties from the 40" length. We recommend that you use a favorite (ripped apart) tie from which to cut the pattern, as tastes differ. We turn the used tie inside out and cut 3 duplicate patterns of the whole tie.

These we lay out on the tie length, fitting the 6 pieces all on

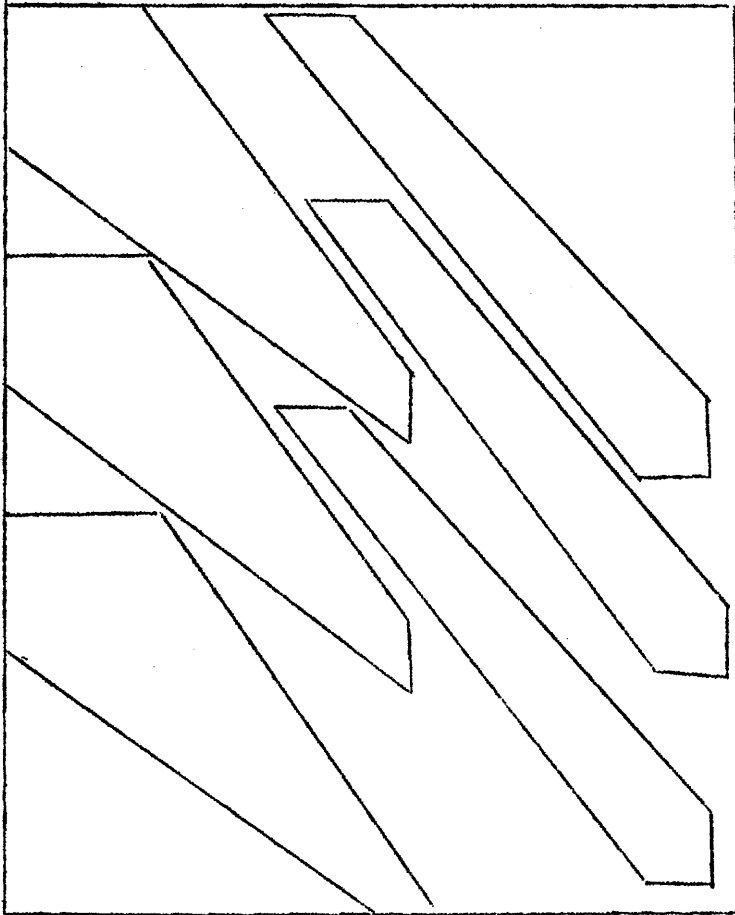

Some manipulation of pattern will no doubt be necessary, hence the three patterns to make the lay-out.

before cutting (assuming the tie has one seam). Factory cotton may be used as the lining. After cutting carefully all three ties, machine seam at neck, and turn in edges with one fold, using a basting stitch. Press. Baste in linings, stitch down with machine and press again. Machine across square ends to prevent fraying. Bring basted edges together over lining, and baste, then slip stitch. Then the final pressing. Care should be taken to have a good proportion around neckline and tying points, as men do not, as a rule, like much thickness.

While we have been writing, the sky has changed, as it does so frequently in the mountains, and a few storm clouds are in sight. We hope the rain holds off until all the travellers

return. However, rain or shine, one of the greatest happenings of our year is being experienced.

We must not close without mentioning the deep satisfaction this year's students have received from lectures in Design by Mr. J.W.G. Macdonald. Mr. Macdonald, who is a well known artist of Vancouver, B.C., is a lecturer who holds his audiences spellbound, and we leave his lectures with a profound respect for his truly great philosophy, and a desire to live up to it. Students from other departments, -- Art, Drama, Oral French, Playwriting, Leathercraft, and Music, one and all meet at 8:45 a.m. twice a week to listen to his lectures and his explanations of the art of the Twentieth Century.

This School is a great experience for the student, old or young, and a source of inspiration to the tired city dweller. We hope, in our talk today, to have conveyed to you some of the spirit of the Banff School of Fine Arts, of which we are privileged to be a part.

Good Weaving!

Ethel Henderson

Mrs. E. M. Henderson
20 Ritz Apartments
Winnipeg, Manitoba

Mary Sandin

Mrs. A. B. Sandin
c/o University of Alberta
Edmonton, Alberta

Because of the considerable use of the "Rigid Heddle" loom in schools, clubs, etc., at the present time, we have had printed a limited number of extra copies of our August bulletin entitled "Two Harness Techniques, suited to the Box Loom with Rigid Heddle". It comes bound in its own yellow cover, and is priced at seventy-five cents per single copy. Within the next month we hope to be able to give the source and price of a satisfactory Box Loom heddle, which we have already tried out. These heddles are stamped out of sheet aluminum, and will be priced at about \$2.00, if available. We're working on it! (Bulletins should be ordered from Mrs. Sandin)

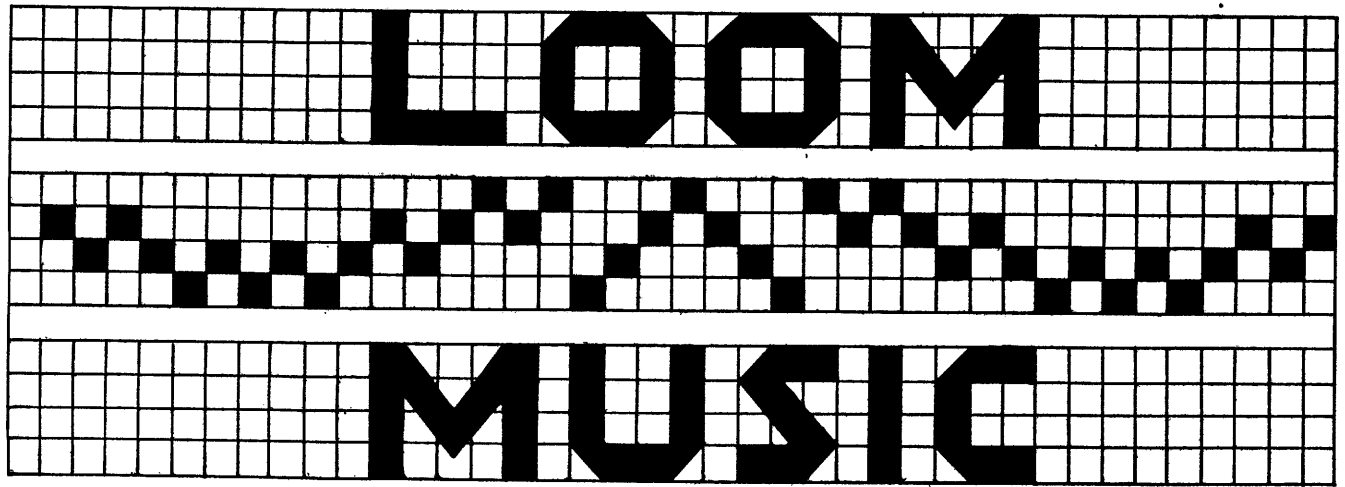

VOLUME II

NUMBER 11

NOVEMBER, 1945

*Mary
Sandin*
Edmonton

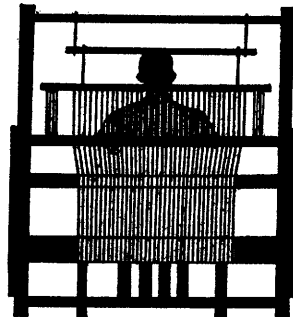

*Ethel
Henderson*
Winnipeg

L O O M M U S I C

Volume II, Number 11

November, 1945

CATALOGNE, or RAG RUGS IN THE QUEBEC MANNER

Catalogne is the name used in the Province of Quebec to denote a particular type of weaving, a type which uses folded strips of rags as weft material. The prevalence and beauty of this weaving give it a place in our pages.

We are much indebted to Dr. J. Murray Gibbon, President of the Canadian Handicrafts Guild, and to Miss Helen I. Drummond, Secretary-Treasurer of the Guild, for their response to our request for authentic examples of the true Catalogne of Quebec. Miss Drummond generously loaned us the pieces we describe herein, and supplied the historical background of each length. We cannot do better than to quote the notes given by Miss Drummond, with her permission

"One story is told that the name comes from Catalogna, Spain, where a similar material was woven, and the weavers were said to have copied the stripes of the Roman stripe silks.

Originally, in Quebec Province, Catalogne was used principally for bed covers and carpeting. Today one finds it adapted in countless ways to modern demands, -- upholstery, curtains, luncheon mats, work bags, belts, and so on, as well as being developed as originally used.

It is usually made with a tabby tie up, and design achieved by arrangement of color in the warp, or weft, or both. Although examples are known, the tapestry and laid-in patterns are not so widely used because they are not economical in time or price. The warp may be of cotton, wool, or linen, but the filler is of discarded rags, which are cut as desired and are joined together to make a long strip; or of mill ends, that is, selvage cuttings and short pieces. The joins are not apparent in viewing the weaving."

In our search for relevant facts, we have read that each district in Quebec had its own particular way of producing

Catalogne patterns, and neighboring parishes vied with each other for excellent workmanship. We say "had", because so many of the old ways are gone -- lost in the scramble of today's economic struggle.

Miss Drummond sent us a grouping from the Permanent Collection of the Canadian Handicrafts Guild, from which we have chosen four lengths which particularly appealed to us. When we showed them to a group of fellow weavers, we found they were all fired with ambition to weave similar colorful lengths. One of the pieces, described below as #4, is down on our kitchen floor (just for the afternoon, alas!) and each glance at it gives a feeling of pleasure, especially since we have a decided leaning to blue-greens and pinks -- from pastels to deep rosy red.

The dyeing is done, as a rule, in each district. While vegetable dyes would have been used in the early days, today commercial dyes are used. For those interested in vegetable dyes, there is an excellent little book "Vegetable Dyes", by Douglas Leichman, published by the Oxford Press, priced at 35¢. It is very practical, especially to Canadians, as it refers to easily obtained plants, roots, and mosses.

In all of the Catalogne lengths described below, the effect definitely depends on keeping the warp material and warp setting exactly as noted. The rag weft material, in general, is cut about an inch wide (depending on the weight of the material), so that when it is beaten back the weight appears about the same as a 4/12 rug cotton. After the strips are cut they are carefully and neatly sewn together, then pressed as follows: a quarter of the width of the material is turned in from each edge toward the centre, then the whole is folded in half, so that the raw edges

noted below, woven in a plaid effect. It was woven to have 8 weft shots per inch. The length was 56" in all, with knotted fringe at each end.

Weaving - all tabby or plain weaving:

	$\frac{1}{2}$ "	plum 8/2 for heading
#1	* 18	shots black cotton
	2	shots orange cotton
	2	shots black cotton
	10	shots orange cotton
	4	shots turquoise rayon
		reverse to *
#2	** 2	shots flowered cotton
	20	shots beige cotton
	2	shots turquoise rayon
	2	shots beige cotton
	10	shots turquoise rayon
	4	shots orange cotton
		reverse to **

There are seven such groups in alternation, 4 black (#1) and 3 beige (#2), with the 2 shots of flowered cotton separating the groups. End with a heading of 8/2 plum, and knot a 4" fringe close up to this heading. The effect of this particular piece is decidedly cheerful.

CATALOGUE #2. This weaving is an example of softer tones blended into a harmonious whole. It was bought in Quebec Province, but has no further notation. The weft was cotton waste from the mills, and the general effect was of light and dark blues contrasted with rosy tones.

Warp: 16/2 cotton, in royal blue and deep yellow, set at 30 ends per inch (double in a 15-dent reed, single in the heddles in a twill threading), 28" wide = 840 warp ends, the details of which are:

158 ends royal blue	16/2 cotton
30 ends deep yellow	"
464 ends royal blue	"
30 ends deep yellow	"
158 ends royal blue	"
<u>840 ends</u>	

Weaving, - all tabby or plain weaving. The colors are of low value, very subdued, except where specified. As there is

no repeat, we will describe the entire weft arrangement, which is of grouped stripes. There were 8 weft shots per inch, and to gain the original effect we give the weaving by inches:

1/2" royal blue 16/2			
double, for heading			
1/2" navy (cotton waste)	3/4" pale yellow	2"	pale yellow
3/4" rose	1" black	2"	blue, varieg.
1 1/4" white	1/2" white	2"	rose
1" pale yellow	3/4" rose	2 shots	pink
3/4" black	1" white	1 1/4"	dark grey
1" milky blue	1 1/4" dark grey	1"	white
1" bright red	1" yellow gold	1"	rose
3/4" milky blue	1/2" blue, varieg.	1 1/4"	black
1" pale yellow	6" rose	1"	pale yellow
1 3/4" navy	1/2" white	1 1/4"	dark blue
1 7/8" black	1/2" blue, varieg.	1 1/2"	blue, varieg.
2 1/2" navy	1/2" rose	3"	dull navy
3/4" milky blue	1/2" pale yellow	7/8"	white
1" rose	2 shots light blue	1"	black
1 1/2" grey	2 shots black	3/4"	rose
1 1/4" pale yellow	2 shots navy	1 1/4"	navy
1 1/2" black	2 shots light blue	1 1/4"	dark beige
1/2" grey	2 shots rose	7/8"	pink
1 1/4" blue, variegated	2 shots blue, varieg.	1"	white
		1"	navy
		1"	yellow gold
		1/2"	blue heading

CATALOGNE #3. This was a most appealing length, being a pastel effect, accented with black, woven in a twill weave. This rug was also woven in Quebec Province. It was quite thick, a good scatter rug weight, woven at 10 weft shots of cotton rags per inch.

Warp: This was a very firmly twisted cotton, about a #10 Pearl weight, in reddish pink, white, yellow, set at 18 ends per inch in a twill threading, 27" wide = 486 warp ends, the details

of which are:	66 ends	reddish pink	twisted cotton
	22 ends	white	"
	22 ends	deep yellow	"
	22 ends	white	"
	222 ends	reddish pink	"
	22 ends	white	"
	22 ends	deep yellow	"
	22 ends	white	"
	66 ends	reddish pink	"
	486	ends	

Weaving. The weft was cotton in colors noted below. The ends of the mat were hemmed back in 2" hems. The total length

was about 50", of which we give details for about 20".

Weave $\frac{1}{2}$ " tabby, using warp thread, for hem's turn-under
Then, in a twill treading, treadles 1,2,3,4 and repeat, weave

4 shots dark brown	4 shots cinnamon brown
6 shots pale blue	4 shots grey
8 shots peach	4 shots yellow
6 shots black	5 shots rose
6 shots pink	4 shots black
6 shots yellow	5 shots light turquoise
6 shots pale blue	6 shots light grey
4 shots black	7 shots rose
6 shots peach	4 shots black
3 shots grey	4 shots peach
4 shots yellow	6 shots beige
4 shots light turquoise	4 shots black
4 shots pale blue	4 shots yellow
8 shots light beige	3 shots rose
4 shots blue grey	4 shots dark grey
2 shots peach	8 shots rose
4 shots black	4 shots light grey
6 shots medium blue	5 shots turquoise
4 shots yellow	6 shots rose
4 shots light beige	4 shots black
4 shots greyish brown	5 shots light blue
4 shots peach	
2 shots dark blue	

Weave to the desired length in this general fashion.

There have been no obvious repeats carried out in this mat.

CATALOGNE #4 is a most unusual example, collected from a tannery in County Charlevoix, Quebec, by Dr. Marius Barbeau. The warp is set in a hit-and-miss fashion and is of a tightly twisted mercerized cotton in both 8/2 and 16/2 weight according to fancy. The warp works out to 24 ends per inch, but seems to have been threaded in a 15-dent reed, 2 ends in one dent and 1 in the next, giving a very uneven appearance. This piece is 34" wide (24 ends per inch, single in the heddles in a twill threading) = 816 warp ends, the details of which are:

- 12 $\frac{1}{4}$ " (294 ends) of 16/2 weight in rosy red. The first 10" (240 ends) are all of the 16/2 weight; then of the last 2 $\frac{1}{4}$ " (54 ends), 6 or 8 ends are the 8/2 weight in a faded red color, added in a hit-and-miss fashion among the rosy red 16/2 ends; the 284th and 290th ends are black 8/2 weight.
- 9 $\frac{1}{2}$ " (228 ends) of a soft dull greenish blue 16/2, with every 3rd or 4th or 5th thread of a dull bluish

green 8/2 weight, there being no regularity in the alternation of the two weights and colors.
 12 1/4" (294 ends) of the 16/2 weight in rosy red and 8/2 faded red irregular alternation as in the first section above, with here the addition of every 5th or 8th or 12th thread a black 8/2 weight not regularly spaced.
 816 warp ends

Weft Material. The weft is a most interesting combination, sometimes cotton, sometimes jute, and sometimes cow hair yarn. This yarn is known in Eastern Canada as "poor man's wool". It is very short stapled and does not wear well, we are told, but does look well. The color used here is dark reddish brown. The jute, too, is brittle and not of lasting quality, although it gives a good texture. This piece was collected at a tannery, which may account for the utilization of the cow hair.

Weaving. The general effect of this length, 3-3/4 yards, is of large squares separated by lighter bands. The large squares are striped across every third group. The ends of the piece are turned in with a hem.

- #1 { 1" white cotton rags
 9" 2 shots white cotton and 2 shots brown cow hair yarn alternated. The same effect could be gained by using a 2-ply homespun.
 1" white cotton rags
- #2 { 9" jute in emerald green. The reddish warp darkens this on the sides and gleams a beautiful blue green in the centre.
 18 to 20 shots per inch { 1" white cotton rags
 9" brown cow hair yarn. This is reddish over the red warp, and purplish over the centre.
- #1 { 1" white cotton rags
 9" 2 shots cotton (white and red figured here) and 2 of cow hair alternated.
 1" white cotton rags

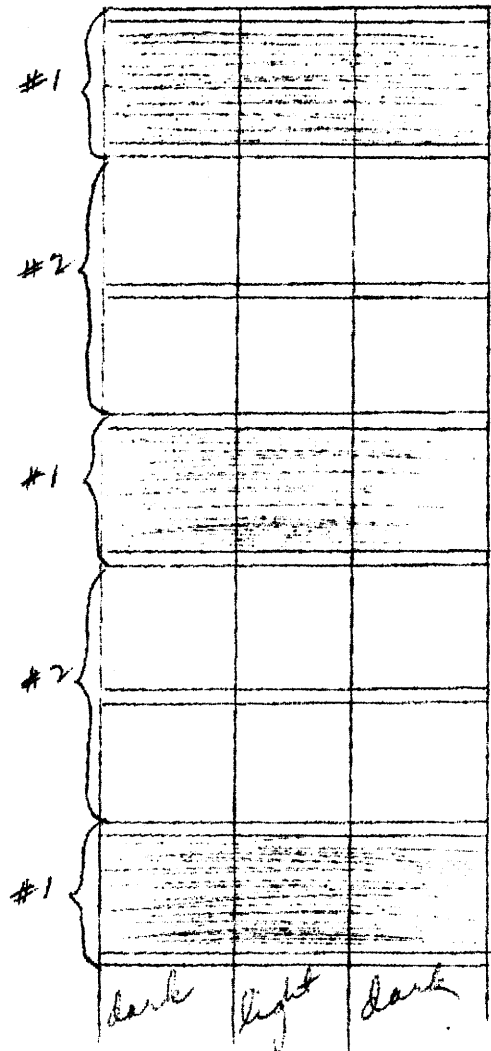

#2 { 9" green jute
1" white cotton rags
9" brown cow hair yarn

This general order is carried out throughout the weaving which is done in a tabby or plain weave. The points of interest are the narrow striped areas, the bright blue green of the jute in the centre block and the wine red of the cow hair in the outside blocks. The color tones are extremely good, giving a rich colorful runner. It would also seam well.

We are indeed grateful to the Canadian Handicrafts Guild, Montreal, for the opportunity of passing these beautiful Catalognes on to you.

Good Weaving!

Mary Sandin

Mrs. R. B. Sandin
University of Alberta
Edmonton, Alberta

Ethel Henderson

Mrs. E. M. Henderson
20 Ritz Apartments
Winnipeg, Manitoba

Per year \$3.00
Single copy .35
Copyright 1945

A young man recovering from Poliomyelitis is doing some beautiful hand spinning, in white only. He does coarse 1- and 2-ply, the latter with a tight spin. The yarn is very smooth, and he will spin to order at \$2.00 per pound. Anyone interested please write Mrs. Henderson at Winnipeg. The 1-ply would be very good for the Ukrainian bags in our September issue, for any weaver doing her own dyeing.

Further to last month's note on page 91: Heddles, stamped from sheet aluminum, for the box or rigid heddle loom, may be ordered at \$2.00 each from Mr. J. Johns, Technical Education Department, Legislative Buildings, Winnipeg, Manitoba.

A new weaving book has just come to hand: "Key to Weaving", (The Bruce Publishing Company, 540 N. Milwaukee St.,

Milwaukee 1, Wisconsin, \$5.00), by Mary E. Black, who is Director of Handcrafts and Home Industries in the Province of Nova Scotia.

At the time of writing, we have not had an opportunity to study Miss Black's book thoroughly, but it is definitely a contribution to our weaving literature. It is full of practical hints and contains many black and white illustrations of various techniques. It should be of considerable help to beginners, and we take great pleasure in congratulating Miss Black and in recommending the book to our readers as a thoughtfully prepared volume. To give you an idea of its size, it contains 306 7 x 10 pages.

The call for back numbers of LOOM MUSIC has been so great that we are having the 1944 issues re-printed. They are promised for November 1st, and may be ordered from Mrs. Sandin at the regular price of \$3.00 for the year. Since 1944 was our first year of publication, some of our subscribers who began with the 1945 issues may desire the 1944 set to complete their files.

LOOM
MUSIC

VOLUME II

NUMBER 12

DECEMBER, 1945

Mary Sandin
Edmonton

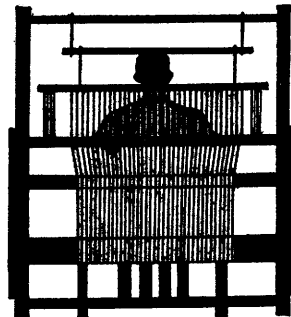

Ethel Henderson
Winnipeg

AN 8-HARNESS DAMASK ARRANGEMENT

We are often asked, by persons considering the purchase of a loom, "What are the advantages and disadvantages of owning an 8 (or more) harness loom?"

During the war years our answer has been an easy one to give, because very few 8-harness looms have been for sale -- none in Canada by any commercial firm that we know of. High import duties have usually discouraged the average Canadian resident from importing a loom of United States manufacture, and in addition to that, fewer of those looms have been available to anyone. It is to be hoped that in the near future a good commercial 8-harness loom will be manufactured in Canada. We did hear at one time that such a project was planned by a reliable firm, and that the looms were being tested by experienced weavers, but have no further information at present. We will be glad to hear from anyone who can tell us about any multiple harness looms manufactured in Canada. So much for the actual purchasing problem at the time of writing.

There is always the possibility of converting a 4-harness to an 8-harness loom, but that is sometimes a risky undertaking. The balance and ease of operation may become lost, and the adjustment a difficult problem to overcome.

However, let us assume that such looms are, or soon will be, available, and the problem is merely one of choice.

Unfortunately, we consider, to many people the first approach to purchasing a loom is the actual cost. We always

counter with the opinion that no investment pays higher returns than the investment in a good loom. On an average, the 8-harness loom will often cost nearly twice as much as a comparable 4-harness loom. The weaving enthusiasts we have encountered develop a really reckless attitude toward the cost question, and the only difficulty they consider is how the cost of this new loom can be squeezed out from the budget.

Secondly, the question of space arises. Here again, it surely is the novice who queries, as it is our experience that the confirmed weaver can make room for just one more loom, even in the face of the walls of the patient family. As one friend says, "We are definitely 'loomy'".

We therefore usually advise the new weaver to purchase a good standard 4-harness loom, confident that in no time at all the loom will fascinate beyond belief. None of us can ever live long enough to exhaust the possibilities of this loom, and we find our friends acquiring two, three, or even more.

It is somewhere during this latter period, after studying various weaving publications, when one may find that many of the drafts that appeal are 8-harness drafts -- Then the 8-harness loom purchase is seriously considered. Our advice is, first, know your manufacturer or consult an experienced weaver. Consider solid construction, good balance, easy threading, and tie-up facilities. Is there room to work underneath the loom? A new tie-up takes a little while under that loom. Indeed, yes!

Damask Luncheon Set

Among our subscribers are many who already own 8-harness looms, and for them we have decided to describe a simple damask arrangement, as we used it at the Banff School. We hope it will prove instructive reading to our 4-harness weavers, and give

Just a reminder, when reversing from centre, do not change the direction of the twill.

The Warp: We must confess to using 24/3 Egyptian cotton warp, set at 36 ends per inch, since fine warp linen was not on the market. This 668 end arrangement gave us a width of 18½" in the reed, and was just right for runners and place pieces. Our warp length was 14 yards, using approximately one 10,000 yard cone of 24/3.

The Weft: This was a #18 lea unbleached singles weft linen (Searle Grain Co.), used singly on the bobbin. (Hughes Fawcett, Inc., New York, for U.S. weavers). The pattern blocks were woven to be exactly square.

The weaving: Our place pieces we wove 14" long, and our table runners 27" long, thus allowing for hems and shrinkage.

Treadling for runner:

Pedals	8765	}	repeated until 18 small blocks are woven, for the border	
	8765			
	4321			
	4321			
Pedals	8765	18 times (or enough to square the large block, never treadling less than the complete unit of 4 weft shots)		
Pedals	4321	8765	4321	once each
	8765	6 times (or squared)		
*	4321	6 " "		
	8765	once		
	4321	6 times "		
	8765	6 " "		
	repeat * twice more			
Pedals	4321	8765	4321	once each
Pedals	8765	}	repeated until 18 small blocks are woven	
	8765			
	4321			
	4321			

For the place piece treadlings, interesting variations may be worked out by first planning proportions on paper.

Just as much may be gained by working the pattern out on squared paper as weaving it at the loom -- more, in fact, as draw-downs will show exactly how patterns are gained -- and it

makes a lovely drawing

Glue Method

For some little time we have been wanting to express our appreciation to Francis Munger, who, in the January-February 1941 number of THE WEAVER (Emile Bernat & Sons Co., Jamaica Plain, Mass.) describes the "Glue Method" of taking woven pieces from a long warp with the least possible trouble and waste of material. Oh, the bottles of LePage's glue we have used at the Banff School! We can cut off a length of weaving, glue, and start using a warp again, while we used to be wondering whether we should cut or not. Briefly, our procedure is this:

1. Directly following the finished piece, weave 1" tabby with carpet warp.
2. Open a tabby shed and insert a spare warp bar.
3. Dribble glue over the 1" carpet warp tabby, and spread it well into the web.
4. When dry, cut warp across at the beginning of the carpet warp tabby, leaving the glue strip to hold the warp ends. (The cut should be made so that about 7/8" of the glue strip holds the warp ends on the loom, and 1/8" of the strip holds the warp ends on the cut off weaving - until it can be machined).
5. By means of looped cords , fasten warp bar to beam, and the loom is ready to use.

NOTE: If you wish to use the loom before the glue is dry, carry out the 1,2,3 as above, then vary the procedure by

4. Lay a 2" strip of paper over the wet glue, and start weaving in front of the warp bar which was inserted.
5. When dry, cut warp across at the beginning of the glue strip.
6. By means of looped cords , fasten warp bar to beam, and continue weaving.

No fuss, no re-tieing, and if you're agile, no glue smeared about. It really works, and so, our grateful thanks to Francis Munger for this help.

With this number we come to the close of another year, a year rich in experience and in the gaining of new friends. The appreciation you have shown is warming to our hearts and minds, and urges us on to continuous faithful effort. To all our subscribers we say "Thank You" most sincerely, and express the wish that we meet again in the pages of the 1946 LOOM MUSIC.

May this, the first Christmas in a world trying to find a lasting Peace, be all you desire it to be, and may 1946 open a vista of a glorious future.

Good Weaving!

Ethel Henderson *Mary Sandin*

Mrs. E. M. Henderson
20 Ritz Apartments
Winnipeg, Manitoba

Mrs. R. B. Sandin
University of Alberta
Edmonton, Alberta

Mrs. M. D. Stronach, Box 322, Antigonish, N.S., writes us that she is no longer producing yarns, but that, to quote from her letter: "Mr. A. M. MacPherson, Rocklin Woollen Mills, Rocklin, Pictou County, N.S., is now turning out the same yarn in his own colours at \$1.35 per pound".

Per year	\$3.00
Sample copy	.35
Copyright	1945

Corner of Runner

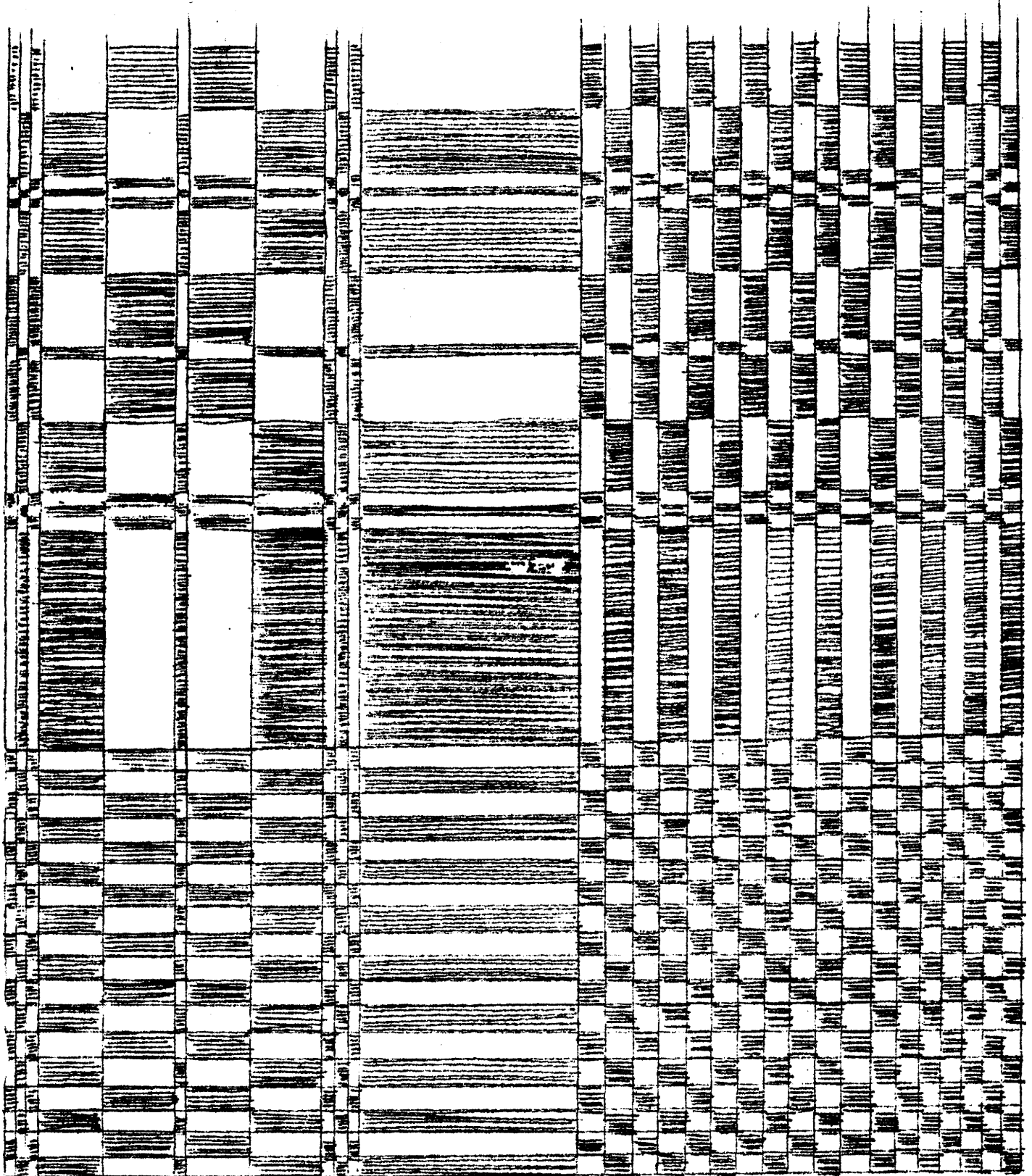

← centre

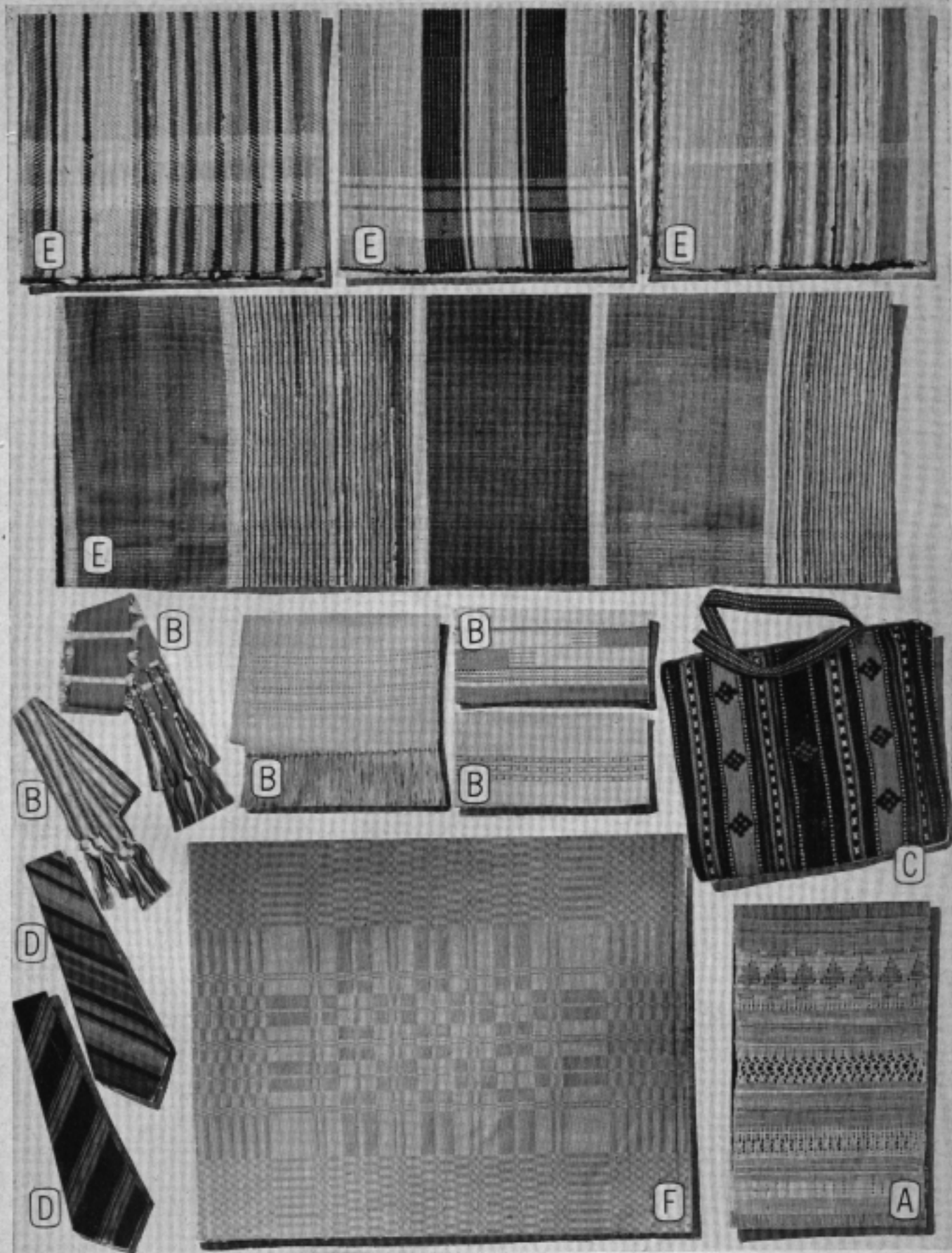

- A. July—Spanish Open Work, Mrs. W. J. McGougan, Winnipeg.
 B. August—Two Harness Techniques, Miss Lena Penner, St. Anne, Manitoba.
 C. September—"Old Country" Bag (similar to Miss Bradshaw's bag), Mrs. W. S. Francis, Winnipeg.
 D. October—Ties, Mrs. H. Lewis, Winnipeg.
 E. November—Catalogne, Canadian Handicrafts Guild, Montreal.
 F. December—Damask.

1945 LOOM MUSIC INDEX

	<u>Volume</u>	<u>Number</u>	<u>Pages</u>
Baby Blanket in Double Weave	II	3	18-27
Bags, "Old Country"	II	9	78-84
Banff: August 1945	II	10	85-91
Bedspreads and accessories in "Chenille"	II	2	10-15
Belts, on 2 harnesses	II	8	66
Book references	II	2	15-17
Box Loom, diagrams	II	8	75-77
heddle source	II	11	99
Brocade, on 2 harnesses	II	8	73
"Chenille" Bedspread and accessories	II	2	10-15
Damask Luncheon Set	II	12	101-108
Danish Open Work, on 2 harnesses	II	8	71
Catalogne, or Rag Rugs in the Quebec Manner	II	11	92-99
Eight-Harness Damask Luncheon Set	II	12	101-108
Four-Harness Overshot	II	4	28-36
Gauze Weave, on 2 harnesses	II	8	71
Glass Curtains in "Swedish Lace"	II	1	1- 8
Glue Method	II	12	106-107
Photograph, January to June weaving	II	6	55
July to December weaving	II	12	109
Rag Rugs in the Quebec Manner	II	11	92-99
Scarves, on 2 harnesses	II	8	67-70
Spanish Open Work	II	7	56-64
Ties, handwoven	II	10	88-91
Two-Harness Techniques, suited to the Box Loom with Rigid Heddle	II	8	65-77
Upholstery in Summer and Winter Weave	II	5	38-45
Variations on a 4-Harness Overshot Theme	II	6	46-54
Weaving "as drawn in"	II	4	34-35