

May 27, 1924.

1,495,311

J. STUER

CIRCULAR LOOM

Filed March 9, 1923

4 Sheets-Sheet 1

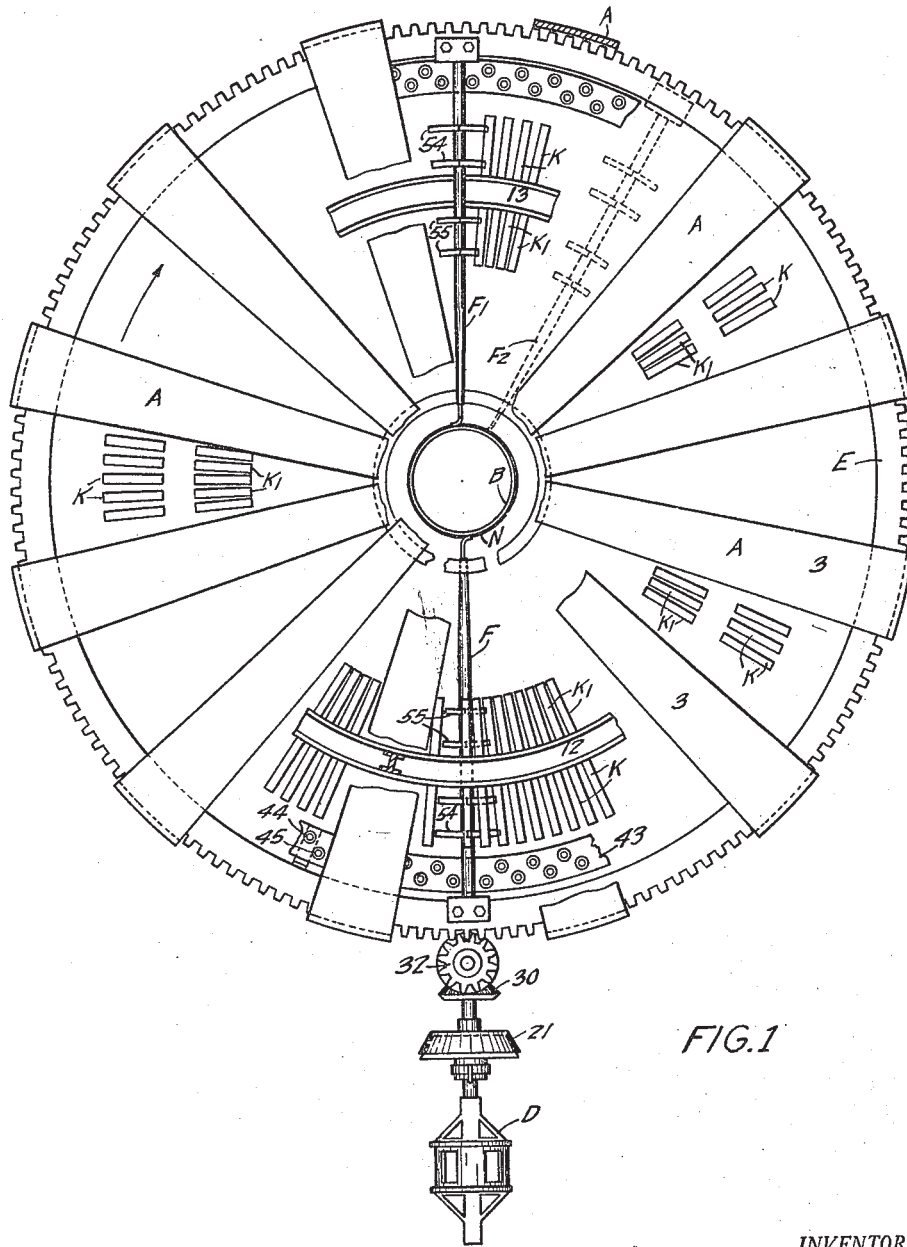

FIG. 1

INVENTOR.
Joseph Stuer
BY
Harold W. Pearson
ATTORNEYS.

May 27, 1924.

1,495,311

J. STUER

CIRCULAR LOOM

Filed March 9, 1923

4 Sheets-Sheet 2

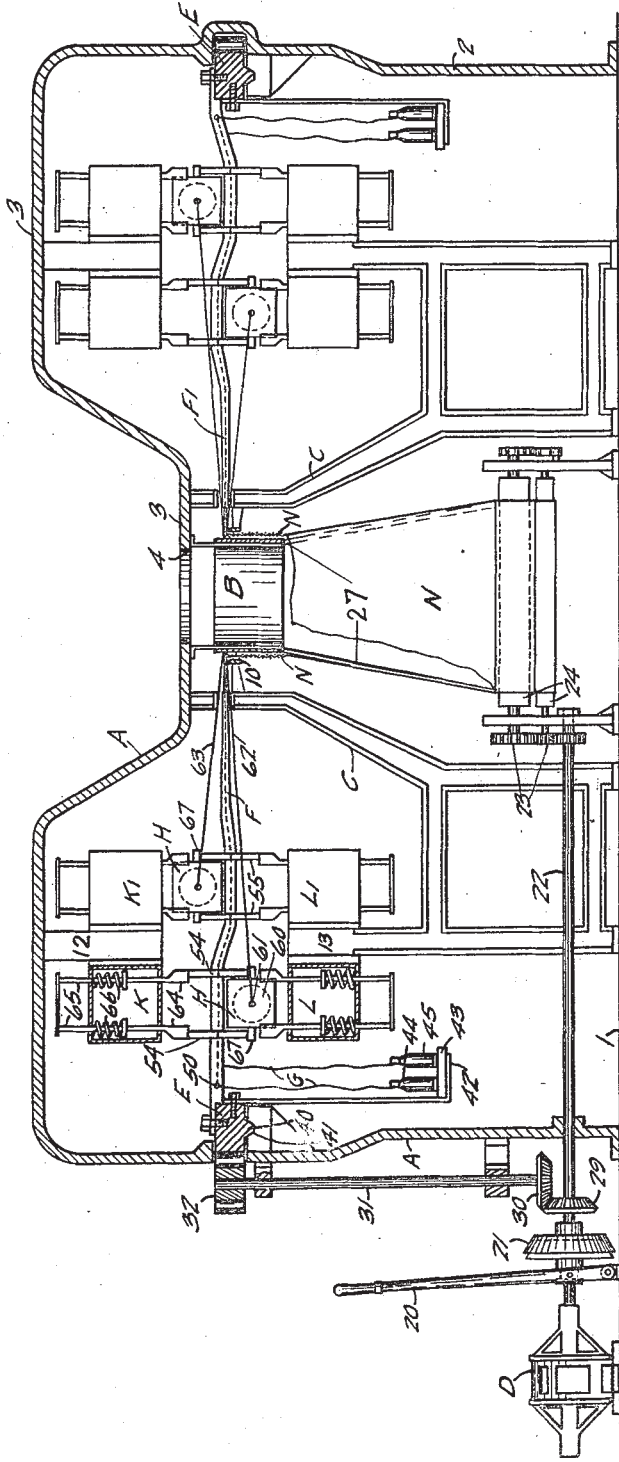

FIG. 2

INVENTOR.
Joseph Stuer
BY *Harold W. Brown*
ATTORNEYS.

May 27, 1924.

1,495,311

J. STUER
CIRCULAR LOOM

Filed March 9, 1923

4 Sheets-Sheet 3

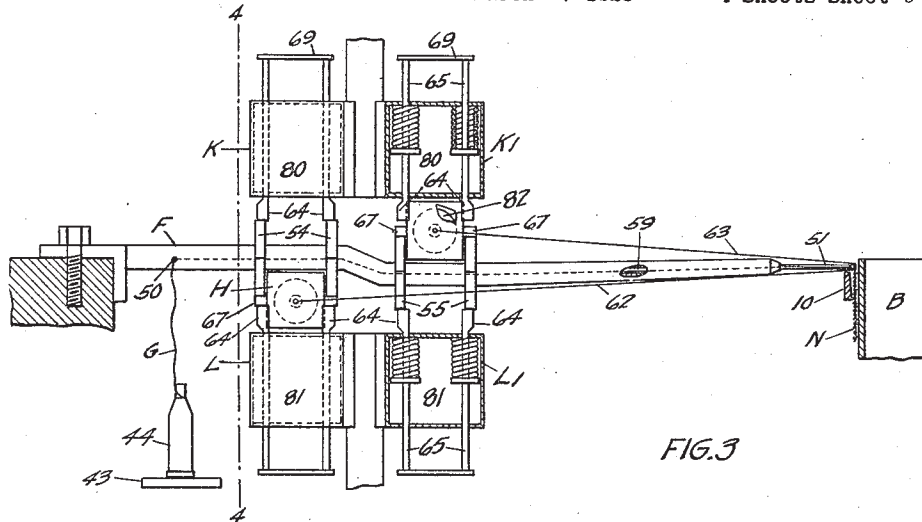

FIG. 3

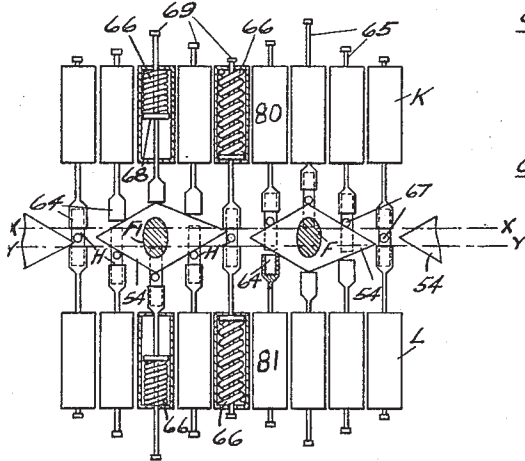

FIG. 4

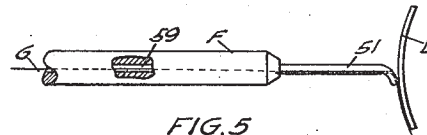

FIG. 5

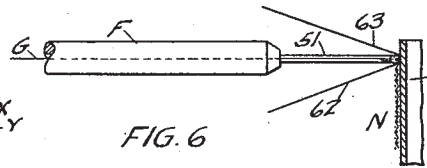

FIG. 6

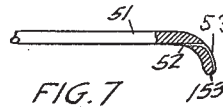

FIG. 7

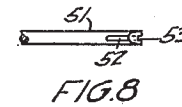

FIG. 8

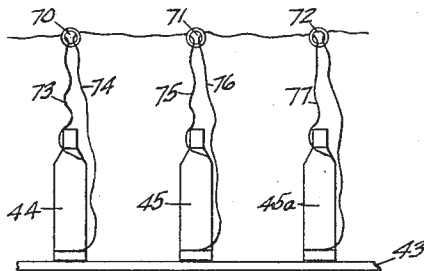

FIG. 9

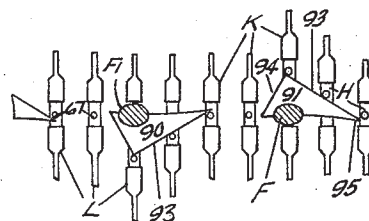

FIG. 10

INVENTOR.
Joseph Stuer
 BY
Harold W. Pearson
 ATTORNEYS.

May 27, 1924.

1,495,311

J. STUER

CIRCULAR LOOM

Filed March 9, 1923

4 Sheets-Sheet 4

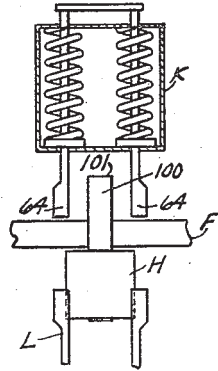

FIG. 11

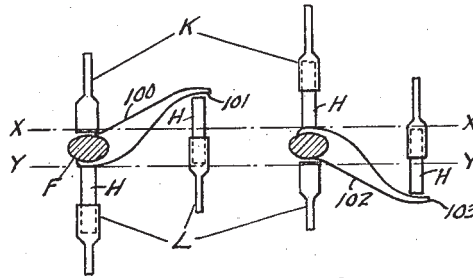

FIG. 12

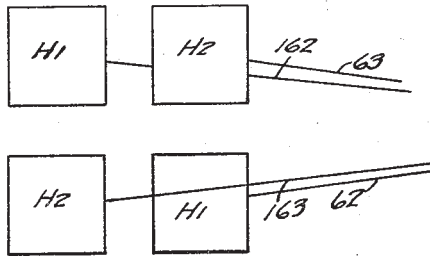

FIG. 13

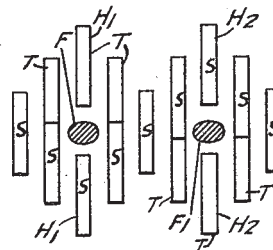

FIG. 14

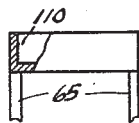

FIG. 15



FIG. 16

INVENTOR.
Joseph Stuer
BY
Harold W. Pearson
ATTORNEYS.

UNITED STATES PATENT OFFICE.

JOSEPH STUER, OF LAWRENCE, MASSACHUSETTS.

CIRCULAR LOOM.

Application filed March 9, 1923. Serial No. 623,994.

To all whom it may concern:

Be it known that I, JOSEPH STUER, a citizen of the United States, residing at Lawrence, in the county of Essex and State of Massachusetts, have invented certain new and useful Improvements in Circular Looms, of which the following is a specification.

This invention relates to the weaving of cloth. It is a loom which weaves a circular tube of cloth having no selvage edges.

I am aware that tubes have been built up by a process of braiding, and that tubes have been built up by certain methods of crossing the threads to hold a filling, such as a paper ribbon, in place, but in my circular loom I weave a regular piece of cloth where alternate warp threads cross in a regular manner.

I can also make fancy weaves on my loom, and can weave tubes of very large size and fine count.

The warp threads in my loom are delivered from warp carriers, such as spools, located in concentric circles, and lead to a cloth tube. These warp carriers are moved in a manner which constitutes what might be known as a full floating warp without loops.

In the drawings, Figure 1 is a plan view of my loom with part of the frame broken away and only two of the filling arms shown in full lines.

Fig. 2 is a sectional elevation of diagrammatic form of the same loom shown in Fig. 1.

Fig. 3 is a detail side elevation showing two sets of cams on a filling arm, with the cooperating warp carriers and guides.

Fig. 4 is a detail elevation as on the line 4-4 of Fig. 3.

Fig. 5 is a plan detail of the finger at the end of the filling arm.

Fig. 6 is an elevation of such finger.

Figs. 7 and 8 are details of such finger.

Fig. 9 shows a preferred arrangement of filling bobbins whereby a continuous ply of filling may be delivered.

Fig. 10 is a view similar to Fig. 4 of a modified construction of cams.

Fig. 11 is a detail showing the application of another type of cam viewed from the right of Fig. 12, with some of the carriers removed for clearness.

Fig. 12 is a side elevation of the type of cam shown in Fig. 11.

Fig. 13 is a diagram showing the arrangement of the warp carriers viewed from the same position as Fig. 3.

Fig. 14 is a diagram of the warp carriers as viewed from the left of Fig. 13.

Fig. 15 shows a modified form of pocket.

Fig. 16 shows a modified form of warp carrier or filling carrier.

In the drawings, A represents the supporting frame as a whole resting on the floor 1. This frame may be of cylindrical form extending upward at 2 which may be continuous or, preferably, of skeleton form, as is also the top 3, 3 which comprises, as shown, arms radiating inward to the ring 4 thereby supporting the interior cloth tube B which depends centrally therefrom. 10 is an exterior cloth tube supported by frame C.

E represents an exterior ring shown as having gear teeth on the outside and an annular nose 40 which rests in an annular bearing 41 supported by frame A. This exterior ring E is revoluble in the frame A by means of a small driving gear 32, the teeth of which mesh with the teeth on E. As shown, gear 32 is carried by a shaft 31 driven by the bevel gear 30 and the bevel gear 29 carried by a suitable shaft 22 which, through the medium of a clutch 21 operated by a clutch handle 20, is driven by an electric motor D.

This shaft 22 through gears 23 revolves the take-up rollers 24 which take up the tube of cloth N as it comes from interior cloth tube B.

Two or more filling arms F, F¹, F², are carried by the exterior ring E and project radially inward in substantially the same plane to the cloth tube B. Each is provided with a filling guide passage 59 through which runs the filling G from the filling bobbins or filling carriers 44 and 45 supported on an annular shelf 43 carried by brackets 42 from ring E.

The filling G extends up through a suitable guide or hole 50 in each arm F, thence through the filling passage 59 and out through a filling finger 51 which projects to the cloth tube B. This filling finger, preferably, curves around at 153 where it touches the cloth tube B and has a hole at 52 from which filling emerges, thence running through another hole and the groove 53 so that the curved part 153 of finger 51 serves the part of a reed in beating up filling between the warp threads 62 and 63.

Referring to the diagram in Fig. 13, I use four warp carriers, indicated by H¹, H¹, H², H².

H¹ and H¹ are both operated by the cams

on a filling arm such as F, and H², H² on an adjoining filling arm. These warp carriers are arranged in concentric rings inside exterior ring E and outside cloth tube B.

The principle of my machine is that when the outside warp carrier operated by any particular arm is raised, the corresponding one on the next interior concentric ring is lowered, and at the same time the adjoining arm lowers the adjoining outside carrier and raises the corresponding carrier on the next interior concentric ring of carriers.

It will therefore be seen that I require pairs of concentrically arranged carriers and pairs of arms each of which has devices which operate to alternately raise and lower the carriers.

Referring to Fig. 14, this raising and lowering the carriers H² and H¹ is clearly shown by the course indicated by the letters S, S, S and T, T, T, with reference to the filling arms F and F¹.

Referring now to the principal drawings Figs. 1 and 2, 13 represents an annular support standing up from the bottom of the frame A, and 12 represents an annular support extending down from the top thereof. These annular supports 12 and 13 support series of pairs of oppositely disposed concentrically arranged top and bottom warp carrier guides. The top carrier guides are indicated by K for the outside and K¹ for the inside, and the bottom carrier guides by L for the outside and L¹ for the inside.

Each of these carrier guides includes the box like support 80 or 81 with suitable bearings for the guide rods 65, the outside ends of which are connected by bars 69. The inside ends of these rods are so formed as to make a pocket 64, the pockets of the top guides adjoining those of the bottom.

I show spring means 66 which normally cause the top pockets 64 of said guides to normally rest in the same plane, which plane is indicated in Fig. 4 by X, X.

In the same way, similar spring means cause the bottom pockets 64 to normally rest in a parallel plane, such as indicated by Y, Y in Fig. 4.

The concentric rings of warp carrier guides are indicated in Fig. 1 by K¹ and K. For each pair of oppositely disposed warp carrier guides, there is a warp carrier H, each of which registers with the pocket of a top and the pocket of its corresponding bottom warp carrier guide and each of which, preferably, is shown as having radially projecting shifting pins 67.

Each filling arm F or F¹ has two or more sets of cams 54, one set arranged to engage the shifting pins on the outside ring of warp carriers so as to raise them, and another set so arranged as at the same time to depress the carriers on another ring.

This is shown clearly in Fig. 3 where the outside warp carrier H is depressed and the inside is raised.

On another, which may be the adjoining arm, is a plurality of sets of other cams, one set so arranged as to engage the shifting pins on the outside ring of warp carriers so as to lower it at the same time that the adjoining arm is lifting another carrier of the same ring, and another set so arranged that at the same time it will depress the warp carrier on another ring while the first-mentioned arm is raising another carrier of the same ring.

In a straight weave, as one arm goes around it lifts the outside warp carriers and depresses those of the inside, while the adjoining arm depresses the outside and raises the inside. It is obvious, however, that one or more arms might be arranged to lift, and one or more other arms to depress, whereby various weaves and various patterns could readily be woven.

It is also obvious that instead of two concentric rings of warp carriers with their guides, three, four, or more might be used.

It is also obvious that with my arrangement of cams and arms, a great many warp carriers can be arranged in a circle and a great many filling arms can be continually filling in so that great speed of production can be obtained.

In Fig. 4, I show diamond-shaped cams 54 the nose of one being at such point that it will strike under the pins 67, and of others so that they will strike over those pins. It is also apparent that the cams are so arranged that while forcing down the warp carriers the same cam is forcing up the warp guides so as to allow a larger space for the arms, such as F as shown in Fig. 4. By this arrangement, greater height and therefore more strength can be given each arm F, and this is a practical advantage.

However, as shown in Fig. 10, I may use a plough-shaped cam 91 having a nose arranged in one case to pass under, and in another case over pins 67. The face 93 is the practical working face, the back end 94 merely allowing the pins with their carriers to slide down easily without banging. The other faces of these cams are shown as inoperative.

As shown in Figs. 11 and 12, the shifting pins 67 can be omitted and cams such as 100 positioned to strike over the middle of each warp carrier H can be used.

In this case the arm F must be of such size that it will pass between the planes indicated by X, X and Y, Y, which indicate the limits of the movements towards each other of the pockets for the warp carriers, and each arm must have room enough to project up and down so that its end will reach over or under a warp carrier H.

The adjoining cam 102 is the same as 100 with an end 103 which extends under the warp carrier H instead of over it.

As shown in Fig. 15 the pockets at the ends of the guide rods 65 may be continuous, as shown at 110.

As shown diagrammatically in Fig. 16, instead of bobbins such as 44 and 45, or spools for carrying the filling, or spools such as 82 for carrying the warp 63 or 62, as shown in Fig. 3, I may use a skein indicated by 115 or any other similar device.

As a practical matter, I may arrange my filling as shown in Fig. 9, wherein 43 is the shelf and 44, 45 and 45^A the series of bobbins arranged thereon, preferably, on suitable spindles, not shown.

The free end from the first bobbin 44 indicated by 73 is passed up through a ring 70, thence to the filling arm, and its other end 74 is passed up through the ring 70 thence down through another ring 71 where it connects with the outside end 75 from the next bobbin 45. The inside end 76 from this bobbin extends up through a ring 71 thence down through a ring 72 where it connects with the free end 77 of bobbin 45^A, and so on. This arrangement permits a number of small bobbins of usual size to be used for the filling.

As my filling finger 51 directs the filling into the extreme angle of the shed, and as the threads of the warp are almost instantly crossed, after it has passed no reed is necessary and it is impossible to form kinks.

I may use an interior cloth tube B and an exterior cloth tube 10 or either of them, according to the nature of the work.

In any case I find it desirable to use cloth spreaders 27, 27 to flatten out the tube of cloth before it is wound up.

I claim:

1. In a machine for weaving cylindrical fabrics, the combination with a supporting frame of an exterior ring revoluble therein, a cloth tube centrally positioned therein, a series of pairs of oppositely disposed concentrically arranged top and bottom warp carrier guides, the member of each pair having a pocket adjoining its other member, spring means for causing the top pockets of said guides to normally rest in the same plane, other spring means for causing the bottom pockets to normally rest in a parallel plane, a series of warp carriers each registering with the pockets of a top and its correspond-

ing bottom warp carrier guide and each having radially projecting shifting pins, a series of pairs of filling arms carried by the exterior ring and projecting radially in the same plane inward to the cloth tube each having a filling guide passage, a plurality of sets of cams carried by one arm of a pair, one set arranged to engage the shifting pins on the outside ring of warp carriers so as to raise them and another set so arranged as at the same time to depress the carriers on another ring, a plurality of sets of cams carried by the other arm of a pair, one set arranged so as to engage the shifting pins on the outside ring of warp carriers so as to lower them and another set so arranged as at the same time to depress the carriers on another ring, a filling bobbin carried by each filling arm, means to revolve such exterior ring with its arms and bobbins, and means to take up the cloth as woven.

2. In a machine for weaving cylindrical fabrics, the combination with a supporting frame of an exterior ring revoluble therein, a cloth tube centrally positioned therein, a series of pairs of oppositely disposed concentrically arranged top and bottom warp carrier guides, the member of each pair having a pocket adjoining its other member, spring means for causing the top pockets of said guides to normally rest in the same plane, other spring means for causing the bottom pockets to normally rest in a parallel plane, a series of warp carriers each registering with the pockets of a top and its corresponding bottom warp carrier guide, a series of pairs of filling arms carried by the exterior ring and projecting radially inward to the cloth tube each having a filling guide passage, a plurality of sets of cams carried by one arm of a pair, one set arranged to engage the outside ring of warp carriers so as to raise them and another set so arranged as at the same time to depress the carriers on another ring, a plurality of sets of cams carried by the other arm of a pair, one set arranged so as to engage the outside ring of warp carriers so as to lower them and another set so arranged as at the same time to depress the carriers on another ring, a filling bobbin carried by each filling arm, means to revolve such exterior ring with its arms and bobbins, and means to take up the cloth as woven.

JOSEPH STUER.