



THE SHUTTLE SERVICE

CRAFT CREATION

The Shuttle Service is a monthly magazine planned as a constructive guide to weavers for the making of "things useful and beautiful."

Ten issues per year \$3.50.

"I saw the weaver choose the threads with care,
Slowly he wove them in a pattern rare."

Craft Creation is a monthly bulletin devoted to the making of useful things by hand.

Ten issues per year \$1.50.

Combination subscription to The Shuttle Service and Craft Creation \$3.50.

OSMA GALLINGER, Editor
GUERNSEY, PENNA.

2- or 4- HARNES LOMS

SIMPLE WEAVING:

Stripes; Plaids

Laid-in; Laces.

2-HARNESS BORDER VARIATIONS

A practical weave for bags, mats, picnic sacks, garden cushions, auto seats, etc. is known as Rips Weaving. It consists in using double warp threads in a Tabby threading on either a 2- or 4-harness loom. Use 8 pairs of carpet warp per in. as shown at A.

For weft, use Peasant Wool, Germantown yarn or Tufting Cotton. A firm coarse texture results.

For columns of color, (see B), use two alternating weft colors, the dark on Shed 1, the light on Shed 2.

Border C. At center of the texture shown at B, one weaves two rows of the same color in succession. The colors are thrown on the opposite sheds. See contrasting textures, C.

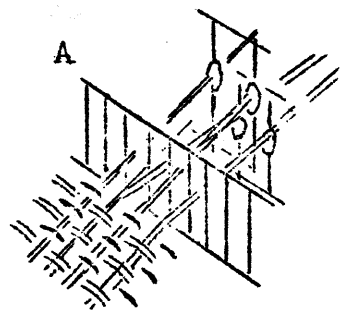
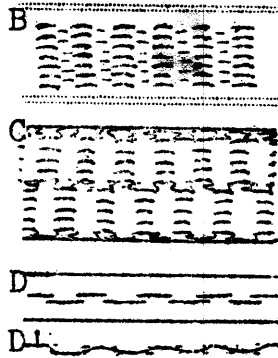

Border D. A very simple yet effective accent is secured by weaving 2 rows only of the same color, D. The general effect is of a single wavy line, (see D'). This outlining border may be woven in light colors on a dark background, or in dark colors on a light background, as shown below in Navajo rug border.

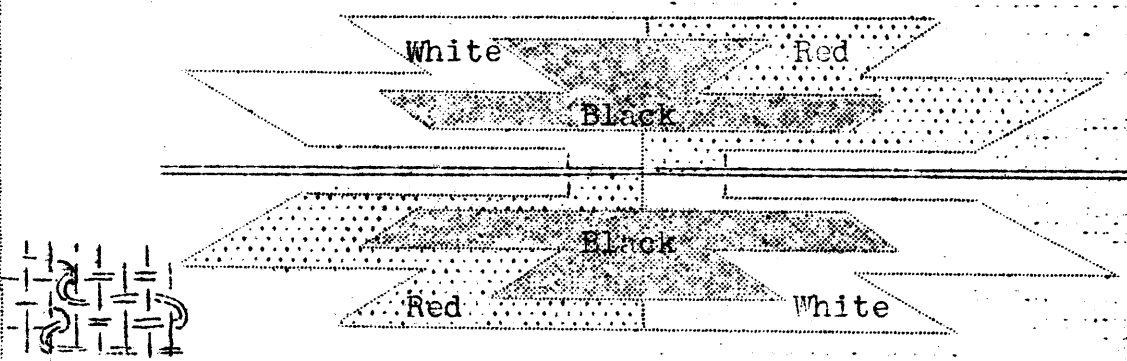

Indian Tapestry Weave Motif:

The motif shown here is woven in red, white and black. For directions, see Folio No. IX. The threads of adjacent sections are interlocked as shown in sketch.

Blue-gray Background.

The Navajo border shown at right is effective because of the use of the ideas given above. The background is gray-blue. Weave 3 in. plain blue at base of mat or rug. Border:

- (a) Weave 2 rows only of white.
- (b): Weave 2 rows gray-blue.
- (c): Weave 7 rows white.
- (d): Weave 2 rows black.
- (e): Weave 2 rows white.
- (f): Weave 7 rows red.
- (g): Weave 9 or 11 rows of (Center) alternate black & white.

Navajo Border

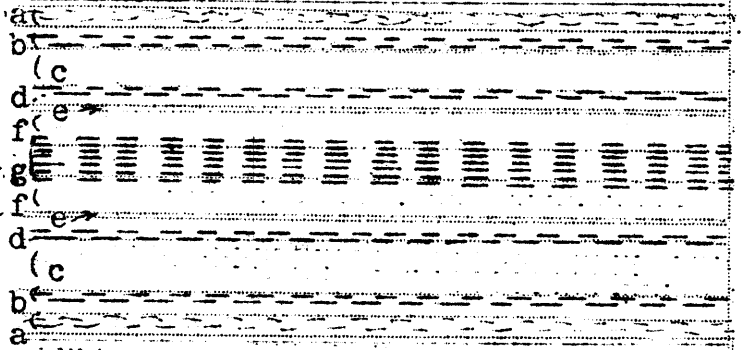

Note: Table Looms are available at Creative Crafts. See advertisements.

Creative Crafts
Guernsey, Pa.

HANDLES WOVEN INTO
BAG PLANNED ON RUG MARP

Bag No.1.
L. 938,
Maltese
Cross.

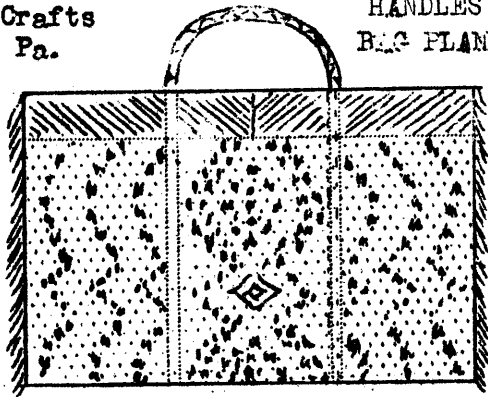

Bag No.2.
L. 934,
Dog-
Tracks.

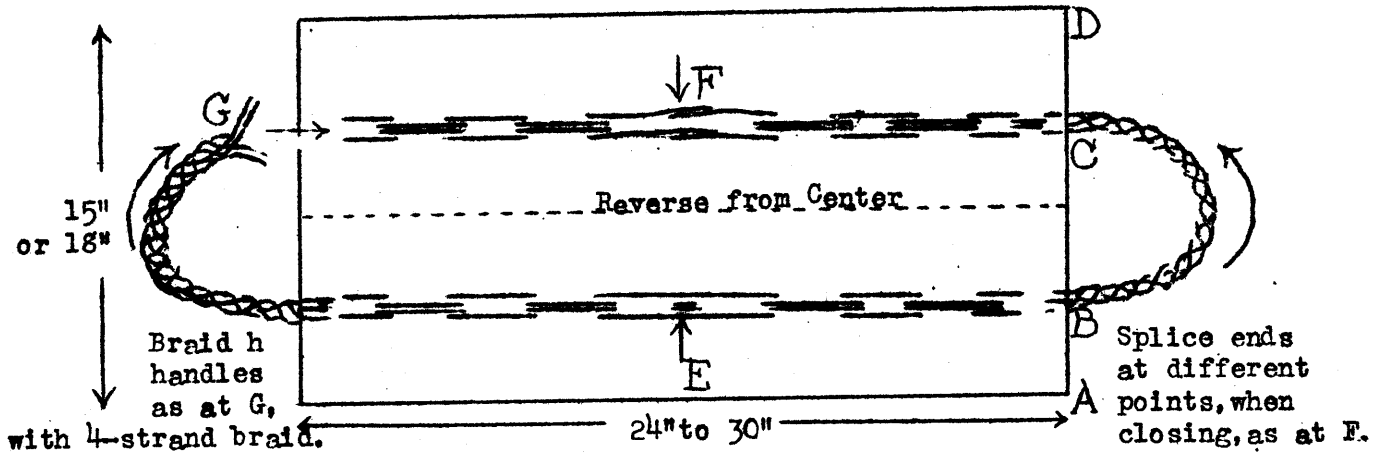
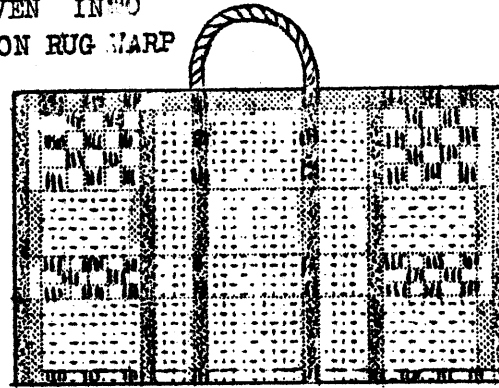

If one's loom is set up for a rug in a 4-harness pattern threading, in a width between 22" and 32", it is practical to weave a section 15" to 18" along warp, and fold it over into a bag, as shown above. The handles are woven right in as part of the pattern, thus making a bag that is strong and durable, with a good selling point.

MATERIALS: Bernat's Rugro, or Lily's Rug Yarn, Art. 614; or Fawcett's Rug Yarn, for pattern weft for heavy knitting bags. For lighter weight texture, -Lily's Rug-Weave Yarn, or Fawcett's 3/2 Cotton used double; or Barided Rug Yarn.

DIMENSIONS: For a bag 18" long and 14" deep, plan design as shown above, weaving A-B, 6"; B-C, 6"; and C-D, 6". It is a good idea to plan design on a large smooth piece of wrapping paper.

COLOR AND DESIGN: One can change the weaving of the pattern to make the sections of the bag effective. For instance, it is effective to repeat a certain treading to form a column.

If using pattern weft of one color only, use a tabby of contrasting color, to set this off. If using two colors in the bag, make the sections of varying proportions for interest. Both colors may be used in the braiding of handles.

Use also Leaflets 934; 817; 906; 922; 933.

PUTTING IN HANDLES: For handles, take four strands of rug yarn; cut double the width of the warp, add 24" for 12" of handle at each side, and 3" for take-up. For instance if warp is set 24", make handle lengths, - 48" plus 24" plus 6", or 78". Fold these lengths double, lay in as part of pattern weft, as shown above at E, placing center of strands at center of warp, E.

If weft is of two colors, put handles where colors change. Supposing Section A-B is brown, section B-C, gold. Make two of handle strands brown, two gold; lay two brown strands in as last two rows of Section A-B; and lay two gold strands in as first two rows of Section B-C.

GOOD PATTERNS TO USE. The bag shown above at No.1, is the Maltese Cross Pattern, Leaflet 938. Thread as directed. Weave:
Dark Rugro: 1-2; 2-3; 3-4; 4-1, once each,
" " : 1-2; 2-3; 3-4; 4-1, twice each,
" " : 3-4, 2 times; 4-1, 2 times.
Light Color: 1-2; 2-3; 3-4; 4-1, twice each.
" " : 1-2, 2 times. (Insert 2 light strands for handle as these two rows.)

Dark Rugro: 2-3, 2 times. (Insert 2 dark strands for handle here.)

Now braid handles at each side.
Dark Rugro: 3-4, 2 times; 4-1, 2 times.
Light Rugro: 1-2, 2 times; 2-3, 2 times.
(1-2) 2 times. This (1-2) is center of bag. Reverse, Weave in handles splicing ends, F.

Old bits of rags from the clothing or outworn household fabrics make excellent rag rugs. Nothing adds a more cheery note to dark corners or bare spots than your handwoven rug; for very drab strips of rag look quite new and fresh when they appear under the magic charm of gay striped warps, or clean white threads of cotton. One should take the time to prepare the rags carefully, and sew them together neatly. If they seem too ragged when you tear the cloth, cut it carefully with sharp scissors instead. Some attractive variations for rug borders are given below, and in the Rug Folio, Creative Crafts Folio No. IV, are found many ideas and directions for the preparation and weaving of rags.

ARROW-WEAVE BORDER, Nos. 1, 2, 3. Weave plain rags for the background. Plan the width and color of your border carefully. Choose rags of two blending or contrasting colors, as at A. One of these may be the former background color. Thread the new end back into the warp, as at A. Open the next shed, and with the hands slip through the two rags. When in the shed, twist them as shown, holding them at opposite end, B. Beat up the cloth, change sheds, then twist the strands again and lay through next shed, as at C. If they are twisted in same direction, they form a diagonal appearance; if in the opposite direction, they form an arrow, as at 1, 2 and 3. Two rows form one complete arrow, as in borders at 3; or a single twisted row forms an accent, as at D. When finished with arrow effect, thread one end back into shed, as at E. See effect of weaving three rows at F.

ACCENTING STRIPES, Nos. 4 and 5. The same designs given below for the arrow rows may be used for simple stripes across the rug warp, in accenting colors. Plan such stripes on check paper. Simple stripes repeated continuously are most effective. Rows of arrow may be laid in at intervals.

LAI-D-IN DIAMOND, G; ACCENTING COLOR SPOTS, H. To lay in triangles or diamonds or simple figures, use a rag of contrasting color and greater thickness, G, than the regular weft. Lay this in as far as desired, every row, progressing to width desired, as at J. Color spots, H, are inserted where desired and ends clipped off.

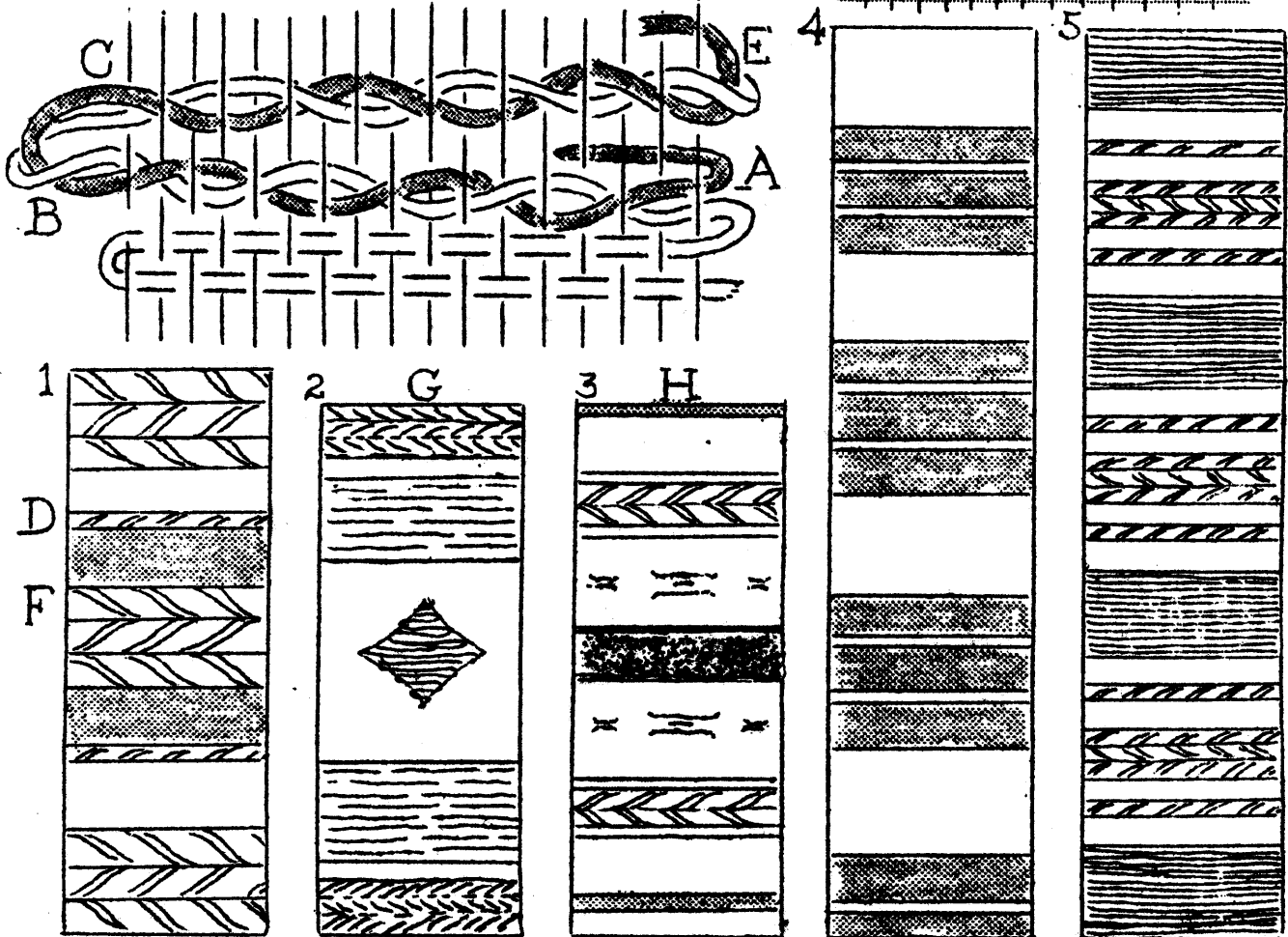

PURSE WOVEN OF CUT STOCKINGS OR SILK RAGS

This is one of those items that can be made at practically no cost. Nicely prepared rags can be woven through either coarse or fine warps. Try them through the warp now on your loom. Silk or cotton rags, torn fine make lovely things.

WARP

To weave rags closely in a texture that will cover the warp, set toweling warp 8 ends to the inch.

DIMENSIONS OF PURSE

Width of warp, 17"
(weaves down to 16").
Finished purse 16" x 10".

DESIGN

Plan stripes on paper first, using your rag colors to the best advantage. You may lay intermittent colors at intervals as shown in sketch.

WEAVING

If using rags, it is not necessary to sew them together, but lay ends of pieces side by side as you weave, as shown at G. The slight roughness of texture is not undesirable. Leave 2 inches fringe at both beginning and end of purse as shown at A. Then weave several rows tabby as at B. This holds the weaving of the purse proper in firm place.

Weave braided handle of rags right into edge of cloth, as shown at C. When finished weaving, fold purse over, wrong side out, as shown at D, pull out all tabby threads at edge except two, then tie each two opposite warp threads together in a square knot, as at E.

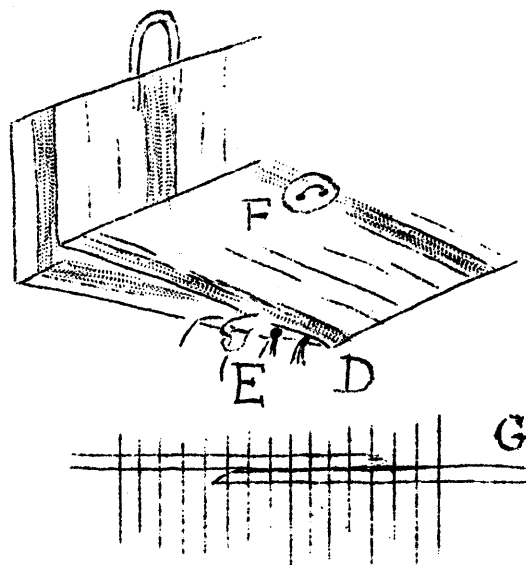
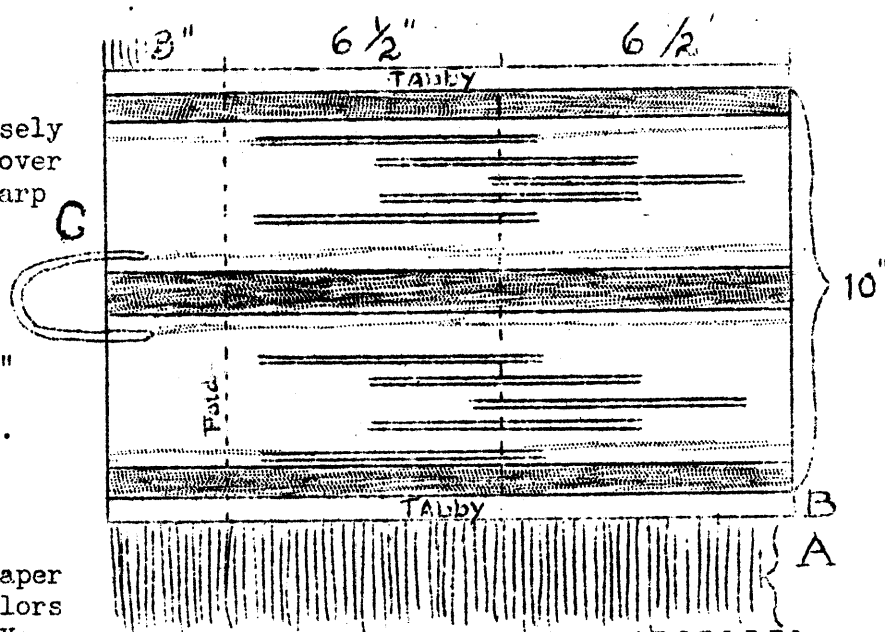

Turn purse over to right side, putting knots on inside.

Put a big wooden button opposite loop or cover a cardboard circle with crochet as at F.

PLAID SET OF BERET, SCARF, AND CUFFS

At Cromaie Crafts we have been weaving authentic Scotch plaids for scarfs, berets, purses and big wide cuffs. We are giving here the warp counts for a true McPherson plaid.

MATERIALS Warp: Bernat's Fabri wool, 1 per dent in a 16 dent reed.
 Weft: Bernat's Miro wool with a silk thread running through is best for a soft full texture; fine Saxony or Shetland may be used.

Note: If you are making only purses and narrow scarfs, you can use a fine cotton warp, 20/2 or 14/2, 1 per dent in a 16 dent reed. The fine wool packs down and completely covers the warp. A sample is shown.

McPHERSON PLAID	Width 20"
12 black	16 threads per inch.
4 white	
6 black	Third time
2 yellow	12 black
6 black	4 white
4 white	6 black
12 black	2 yellow
20 white	6 black
3 dark red	4 white
5 white	12 black
3 dark red	
<u>18 white</u>	Total no. threads
Repeat twice	236

For same pattern in browns, substitute dark brown for black, light tan for white, medium tan for yellow, light orange for red.

MAKING SET OF BERET, SCARF, PURSE, AND CUFFS

For the complete set, weave 38" of 20" wide material. Cut as shown. Crown of beret, A, is an oval 6 x 4 1/2", rather pointed at ends. Side of beret, B, is a strip 3" wide. Diagonal scarf, C, is 20" on each side. Two cuffs, D, are 14 1/2" on each side, corners cut off as at arrows, folded as at E. Purse, F, is cut out of a triangle at center 20" on sides.

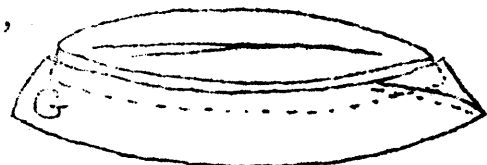
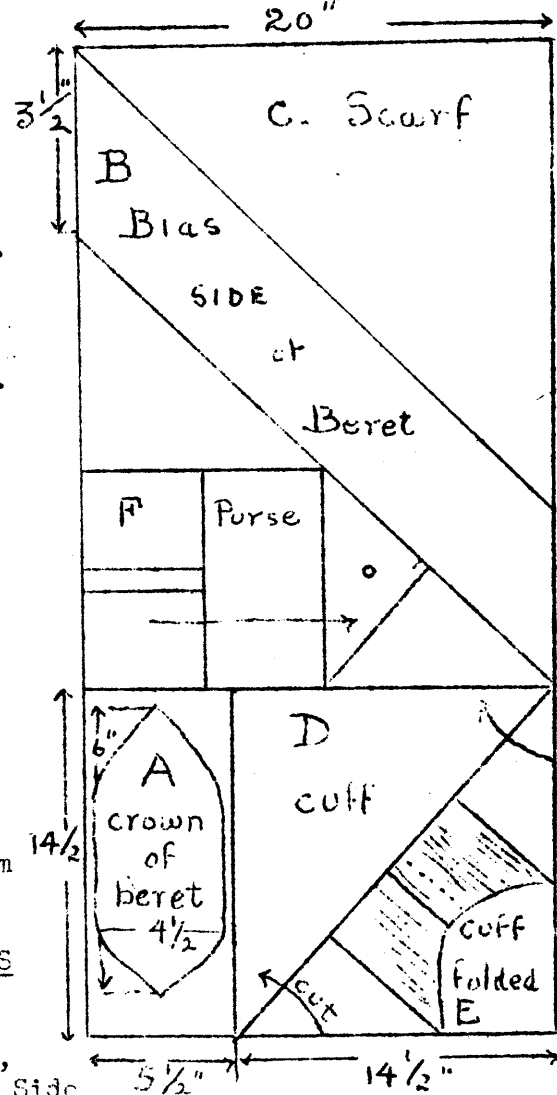

To make beret, sew bias strip together at ends, laying selvage over selvage. Turn both upper and lower edges under, baste and press. Lay crown under top edge, as at G, stitch flat, then roll edge of crown under pressed down edge of bias band. Roll one side of hat under an extra half-inch as at arrow. Clip beret to hair at this point with metal or bone clip. Fold hat flat to make crease down center.

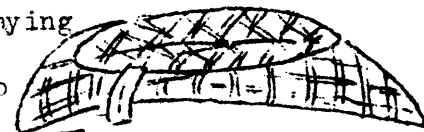

A COUCH COVER OF WOVEN STRIPS OF RAGS

A project suitable for any loom, this practical couch cover of rags, rug filler or waste strips of cloth, is made by sewing together separate woven strips each measuring 12" wide and 60" long. Tie fringe at the end of each strip, as at A, then sew together, as at B. A simple color plan is to weave the strips of contrasting colors, and alternate them as shown here: no.1, dark; no.2, light, etc. One may also put a design at the two ends of each strip, as at C, but great care must be taken to make the stripes in each section the same size and the same distance apart.

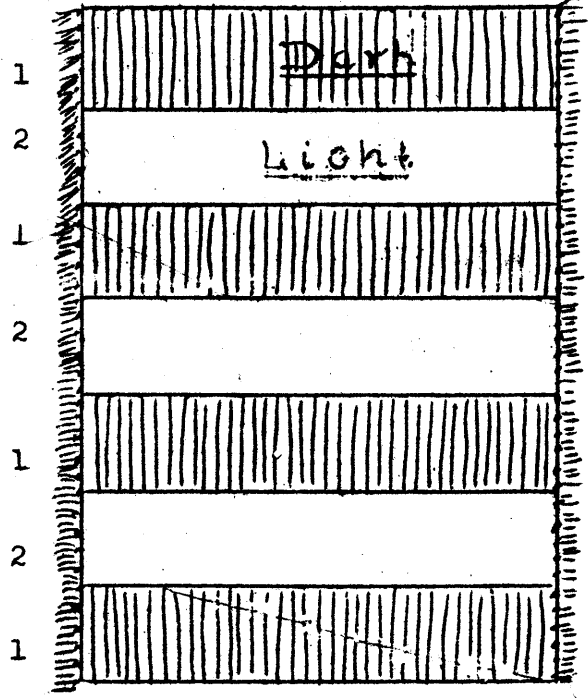

WARP PLAN:

Width in Reed: 13 inches (weave down to 12 inches)

Threads per inch: 16 threads, but group them as 8 pairs of double threads, putting a pair in every other dent of a 16-dent reed or in each dent of

Total no. of threads: 104 pairs or 208. (8 dent.

Length of each strip: Weave strips 58" long plus fringe. (On Lezur Loom extend to full length.

Cost of Warp: For each strip, \$.12.

THREADING:

Thread as a twill pattern on a 4-harness loom, 4,3,2,1; or just simple tabby threading on a 2-harness.

WEAVING:

Weave as a tabby, 1&3, 2&4. For weft use fine rags torn to about a 1/2" width. If one takes care when cutting and sewing rags to make them even, one can make useful and beautiful things of them. You may make a very attractive couch cover of mottled rags.

Fine silk rags are also splendid material. If you prefer to use even material, use Thrifty Knit at .25 per ball, or fine mop rugro at .50 per lb. With a little persistence one could also weave pillows of the same material. These homespun decorations are often the very smartest.

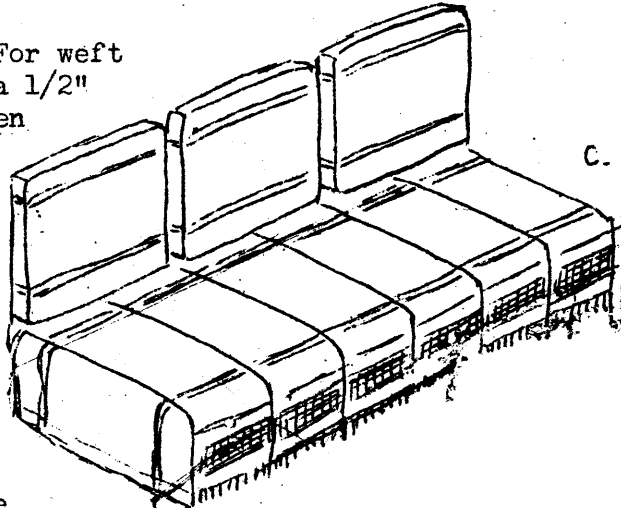
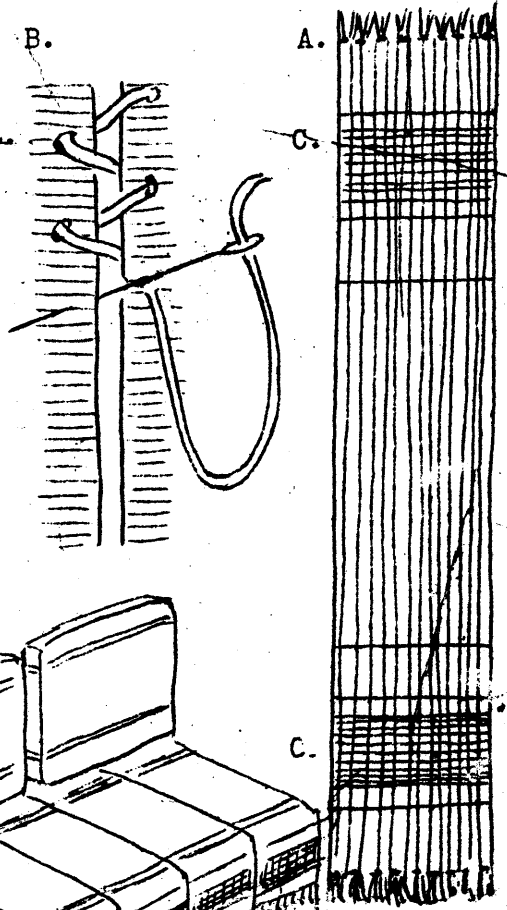

A SCOTCH CAP OF WOOL

(This may go with a woven strip, useful as a scarf, or colorful touch at collar.)

KIND OF WOOL: Warp: Medium weight Shetland, one per dent in a 16-dent reed. Weft: Shetland or Saxony.

DIMENSIONS: Cap: Woven length, 21"; width 10 1/2".
(The width of woven strip for cap should be 1/2 the circumference of your head.)

Scarf: Woven length, 42"; width any width desired from 10 1/2" like cap or narrower. Cut threads off from either side of warp to make narrower.

DESIGN OF WOVEN STRIPS: Work out a border motif measuring 1 1/2" wide, similar to that shown at A, B, C. Repeat this at intervals, with from 4" to 5" between.

COLOR: Make background color faun or silver gray and use two contrasting colors, or a light and a dark color for the stripes: such as green and orange, gold and lavender, brown and yellow, red and black.

HOW TO WAVE: Start scarf with 1" plain background color. Overcast first row over warp threads while still on loom.

Section A: 1 row light color. 3 rows of the darker color with tabby between. (Use accessory stick shuttle that passes over 4 thds. and under 2 thds. all the way across, as at X. Shed must be neutral, all threads level) Finish A with 1 row light.

B: 3 rows bkgr. color. C: 2 rows dark.

D: 10 rows bkgr. E: alternate light and dark for 8 rows. F: 10 rows bkgr. G: Same as ABC. (To continue with scarf, H: 15 rows bkgr. I: 2 rows dark. Continue with intermittent stripes.)

M. KING OF CAP: Overcast last row of weaving, J; fold piece double and overcast sides together, as at K. Turn over and press seam flat.

Turn up bottom edge and roll under to bring stripe at center of roll. Blind-stitch to cap proper, L.

Fold two corners down and fasten to cap next to bottom roll, as at M. Ornament with buttons or tassel. Catch other side down on a diagonal, and roll point under bottom of cap, or cluster under a button.

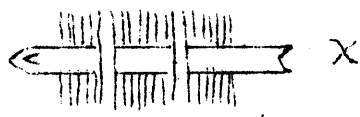
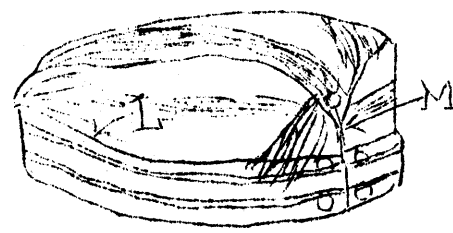
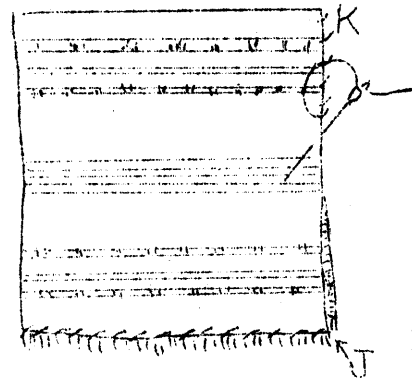
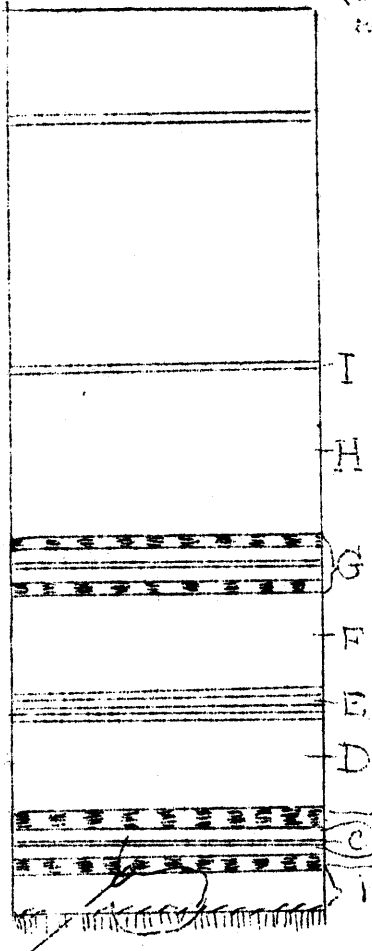

**COTTON TEA OR BRIDGE CLOTH IN TWO PANELS
WITH NAPKINS TO MATCH
A Soft Two-toned Plaid**

Leaflet 748

Reasonable table covers and napkins may be woven at home out of cheap cotton. What is of use to the weaver will also appeal to the customer. The cloth and matching napkins given here were inspired by a napkin in the museum at Mt. Vernon, bearing the family signature of Washington, - and actually used by George and Martha Washington in Colonial Days. There are two colors used, - one, a background color for the main part of cloth or napkins; the other, an accent color in a thread a bit heavier than the background. The cloth may be light with dark stripes, the napkins, dark with light stripes, or vice versa; or both may be of the same colors. Although we have planned a napkin texture finer than the cloth, it is quite possible to weave one's napkins on the warp of the cloth, taking out enough warp at each side to make the correct width.

DIMENSIONS: Cloth, 42" square, made of two strips woven 22" wide and 44" long, shrinking down to strips 21" x 42" when taken off loom and hemmed.

Napkins, 15" square, made of woven pieces 16" wide on loom, and 18" long, shrinking down to 15" square when taken off loom and hemmed.

COSTS: Single strip, 21" x 42" - - \$.40
Two strips, sewed together to make finished cloth - .80

Four napkins at \$.08 each - .32
Total Cost of set - - - - \$1.12
(Note: This covers actual thd. in material, not waste)

WARP PLAN FOR NAPKINS

Warp: 20/2 ply cotton
Weft: The same.
Textured Thds: Cro.Cot.
Width of Warp: 16"
Thds. per in.. 30
Total No.Thds.480

WARP PLAN FOR TEA CLOTH

Warp: Perugian Filler or 12/2 or 14/2 cotton.
Weft: The same.
Textured Thds.:Cro.Cot.
Width of Warp: 22"
Thds. per in. 24; Total, 528

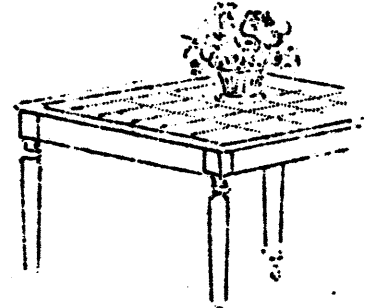

STRIPES IN WARP: THREADING:

Thread 31 bkgr.thds.20/2
for border - - 31
Thd. 1 colored thd. 1
12 bkgr. thds. - - 12
1 colored thd.- - 1
Center, 20/2 cotton-390
1 colored thd.- - 1
12 bkgr. thds. - - 12
1 colored thd.- - 1
31 bkgr. thds.border31
Total - - 480

STRIPES IN WARP: THREADING:

Warp and thread 32 thds.bkgr.color,12/2, etc.- 30
1 heavy texture thread, crochet cotton, 2d.col. 1
10 threads bkgr. color, 12/2- - - - - 10
1 heavy texture thread, - - - - second color- - 1
64 threads bkgr. color, 12/2- - - - - 64
Repeat 76 threads in bracket 5 more times - - 380
Add 1 heavy thd. 10 bkgr. thds. 1 heavy thd.- 12
32 thds. bkgr. color, 12/2 at end- - - - - 36
Total Threads- 528

WEAVING PLAN: Weave 1" tabby at start for hem & shrinking. Weave rest of napkin with same threads and count as warp. Add 1" at end. Total length, 18".
(See also Leaflet 725)

WEAVING PLAN: For strip 21" x 42":
For hem and shrinking, weave 1" plain tabby at start
Then weave, same count as warp: 32 thds. bkgr;
*1 heavy; 10 bkgr; 1 heavy; 64 bkgr.-Repeat from *
12 times.
Add 1 heavy, 10 bkgr; 1 heavy; 32 bkgr. thds. Add
1" plain tabby at end for hem and shrinking.

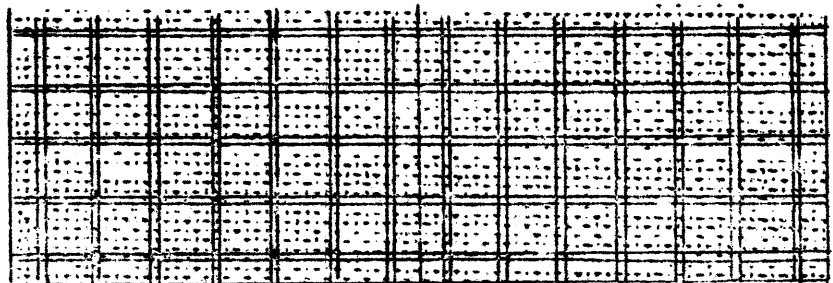
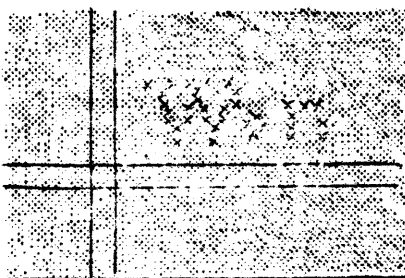

Sew two strips together ↓ at arrow.

A BRIGHT COLORED RUNNER

709

Woven on a 2-or 4-harness loom,
an imitation pattern weave.

Bright cheery table runners for living room or bedroom, for the hall table or that little stand in the dark corner, may be woven on a two-harness loom in imitation of pattern weave. Only one weaving thread need be used, and the pattern is made by the warp threads that are planned in stripes. The same piece cut up in 8" sections will make splendid hot plate mats. It is also excellent for pouches, beach bags, school bags, purses, heavy belts, and pine pillows.

Warp: Colored Carpet Warp in two colors.
Weft: Thrifty-Knit in white or a color.
Cost: Warp for 5 yds, two 1/2 lb. spools
warp: .60. Weft for 5 yds, 3 balls
Thrifty Knit at .25, -.75. Total
cost for woven goods, \$1.35, less
than .01 per inch.

Dimensions :

Runner: 18" X 10", - \$.18
Hot mat: 8" X 10", - .08
Bag, 2 pieces 8" X 10", - .16

If using 12-dent reed, thread
warp 2 threads per dent, with
following plan:

A-B:	61 threads
B-C:	121 "
C-D:	57 "
Total	239 "

If using Lezur Loom, 8 dents per
inch, thread 2 threads per dent,
and repeat B-C only 4 X. making
total of 162 threads. Same count
applies to 16-dent reed, 1 thread
per dent.

IMITATION MONK'S BELT PATTERN

Repeat 11X

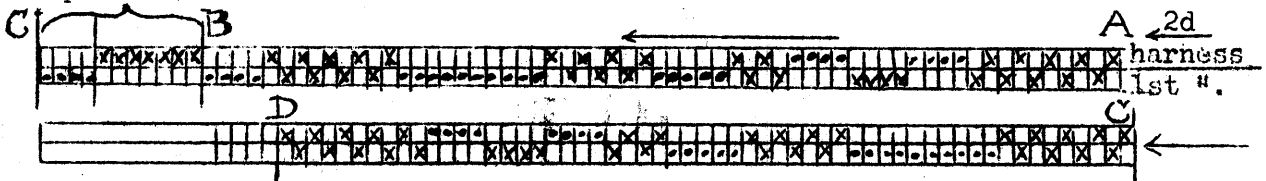

WARPING: Follow simple warping directions
for your home-made warper or Cromaine Warp
Board.

10 dark	7 dark Repeat
4 light	4 light 11 times
4 dark	9 dark
4 light	10 light
4 dark	7 dark
5 light	5 light
7 dark	4 dark
10 light	4 light
9 dark	4 dark
4 light	4 light
	10 dark

After one weaves one pattern
in this way, one may invent
others; just change the blocks
of color around, as at E.

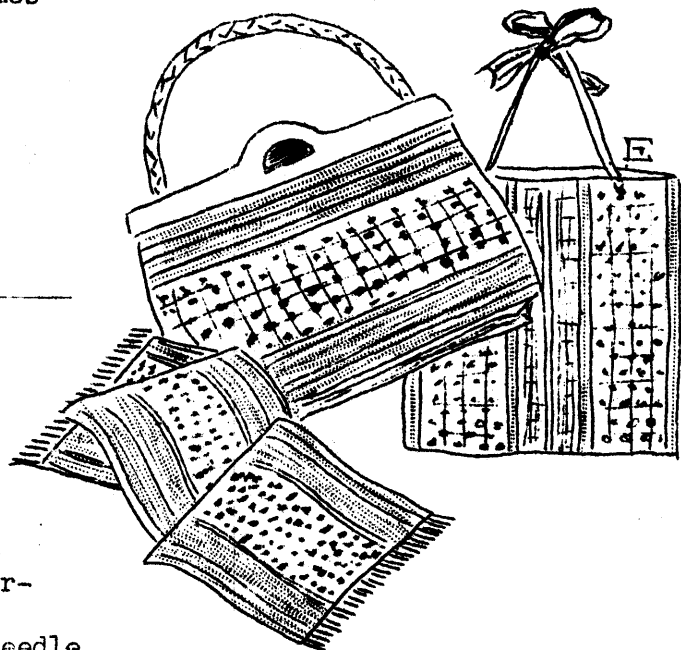

Thread as shown in diagram above,
threading dark threads wherever there
are crosses, and light wherever there
are circles. For instance the first
group of 10 dark threads is threaded:
one in 2d harness, one in 1st, one in
2d, one in 1st, etc. Then come 4 light
threads in successive needles on 2d har-
ness, then 4 dark on 1st harness, etc.
Every thread goes through a separate needle.

There is such a chance to bring out the colorings of rich-toned flowers or fruits in handwoven dining room accessories. The border colorings of linens or buffet sets may match the dishes or be of a color complementary to them, bringing in these hues of nature for accent,— deep peach or cherry, lush rose or lavender, delicate lilac, rich plum or magenta. The background color of the handwoven may be suggested by a color in the design of the china. A stripe using one of the accent tones and other harmonious colors may be laid along all four sides; or the same stripe design may be repeated across the linen, to be woven as a plaid in all-over design. In the plan given here, a soft background color and four fruit tones were used. This is effectively used as a runner for a bowl of fruit on the sideboard.

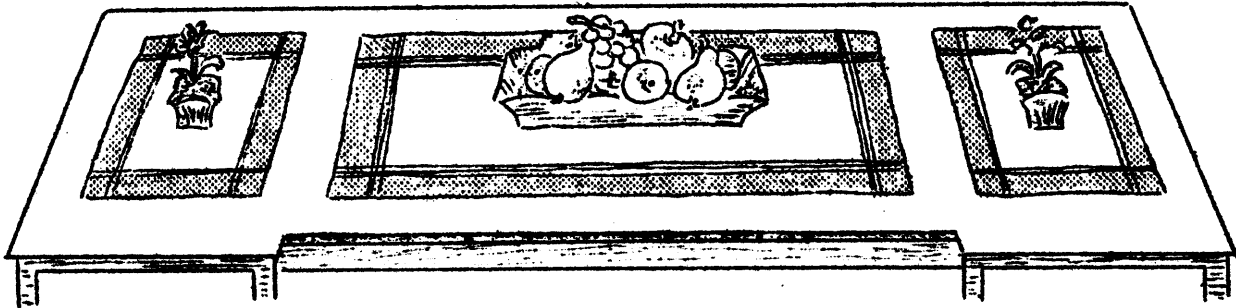

PLAN: The buffet set is planned as a three-piece set, woven on a warp 16" wide, which weaves down to 15". Large center piece measures 15" x 22"; two end pieces, 10" x 15".
MATERIAL: Use Umbrian Warp, or 20/2 or 20/3 colored, for both warp and weft.
WARP PLAN: Width in reed: 16 inches.
 Threads per in: 32 or (30). Total No. of Threads: 512, or 480 for 30 thds.

COLORS: Two good combinations are as follows:
 1. Bkgr. Color, A, green; Border colors,— B, rose; C, cream; D, lavender; E, peach.
 2. Bkgr. Color, A, cream; Border colors,— B, blue; C, yellow; D, green; E, wine.

WEAVING:

Large Piece:

1 1/2" bkgr. color, A — — — — 1 1/2"
 (This allows 1/2" for hem or fringe).
 Border: 6 thds. B
 6 thds. C — — — — 5/8"
 6 thds. D
 6 thds. E

Center: Weave 20" on loom. This allows 2" for shrinkage — 20"
 Reverse from center, adding border at other end, E, D, C, B.
Total Length: 24 1/4" which will shrink down to a finished piece 15" wide and 22" long, after hemming and pressing.

THREADING: 32 thds. bkgr. color, A — — — — 32
 Border: 6 thds. B — — — — 6
 6 thds. C — — — — 6
 6 thds. D — — — — 6
 6 thds. E — — — — 6
 Center: 400 thds. bkgr. color, A — 400
 (or 368 for 30 per inch)
 Border: same as above, reversed — — 24
 i.e. thd. E, D, C, B.
 Second end: 32 thds. bkgr. color, A — 32
 Total No. Thds. — — — — 512

End Pieces:

1 1/2" bkgr. color, A — — — — 1 1/2"
 Border: 6 thds. B; 6, C; 6, D;
 6, E; — 24 thds. weaves to 5/8"
 Center: Weave 7" — — — — 7"
 Reverse from center.
Total Length: 11 1/4", shrinks down to finished piece, 10" x 15".

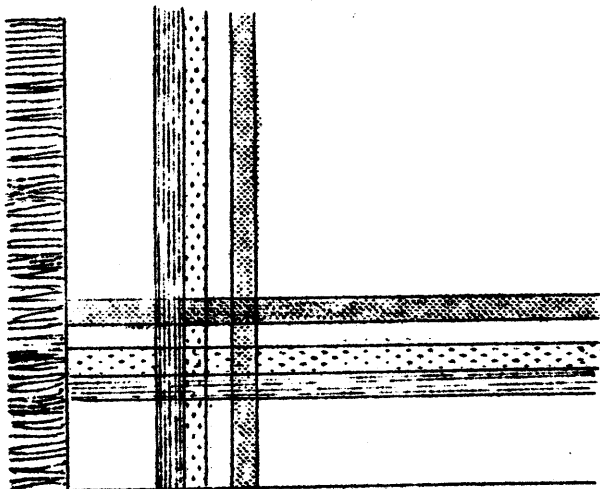

Another Good Border Stripe: Choose 2 contrasting colors, X & Y. Thread 32X; 8 Y; 8 X; 16 Y; 3 X; 16 Y; 8 X; 8 Y; 32 X; 250 Y for center. Reverse.
 Weave by exactly same count.

SUN CURTAINS FOR SPRING

A Texture Pattern

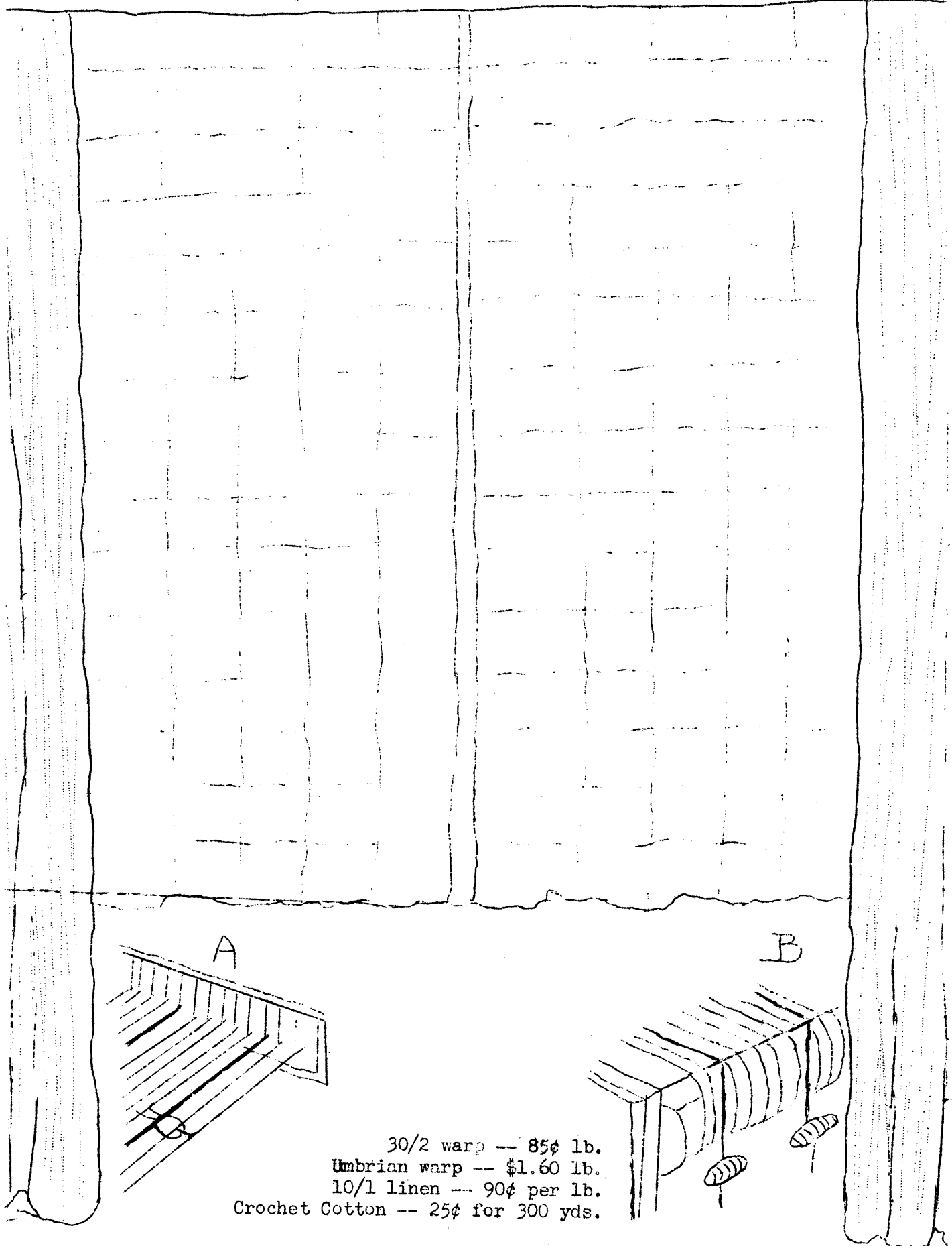

30/2 warp -- 85¢ lb.
 Umbrian warp -- \$1.60 lb.
 10/1 linen -- 90¢ per lb.
 Crochet Cotton -- 25¢ for 300 yds.

EFFECTIVE PERLE DRAPERIES IN STRIPES

L. 712

Most effective living room or sun porch draperies may be made by using a reasonable quality warp in colored stripes, set at 12 threads to the inch. The stripes may be of several shades of the same color, or in several different colors. The thread used for weft may be just carpet warp, crochet cotton, or a perle. For effects in vertical stripes, use one color of weft throughout. For effects in plaids, cross with the same colors of weft as you have used in the warp, and count off the same number of threads for each color as appears in the warp. For low rooms the vertical curtains are excellent. For high rooms, you may plan a perfectly plain warp, and weave in horizontal stripes according to the proportions given below.

MATERIAL: Warp: Perle 5, or Linen 18/2 or carpet warp 8/4.
Weft: Crochet Cotton, carpet warp, perle 5, or boucle¹.

WARP PLAN A: Choose 3 colors, dark, middle and light. (D, M and L)

Threads per in. ----- 12

Width in sley ----- 32

Total no. of Thds. ----- 384

Thread twice through the following pattern, then only as far as *.

PATTERN REPEAT: (follow diagram) 18 D; 6 L; 12 D; 12 M; 3 D; *; 42 M; 3 D;
15 L; 21 M; 3 D; 30 M. (Total 165.)

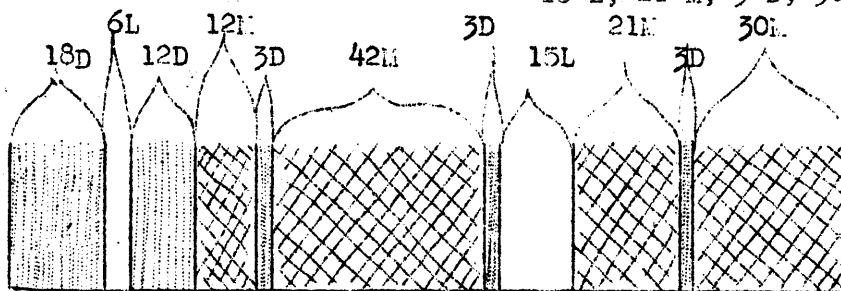

WARP PLAN B: Choose 5 colors corresponding in value to those used here: or use 4 shades of the same color and an accent color.

Threads per in. ----- 12

Width in sley ----- 26"

Total no. thds. ----- 312

Thread once through as given, no repeat.

PATTERN: 72 brown; 21 orange; 51 tan; 12 gold; 30 orange; 60 gray; 21 gold;
45 brown; (Total 312)

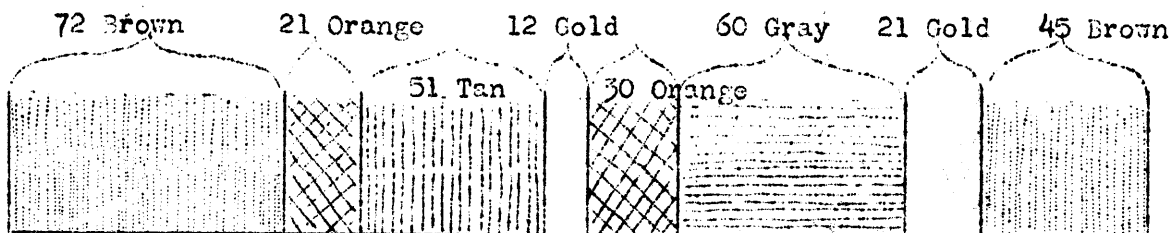

COST OF THREADS

Carpet Warp 8/4, comes in all colors: \$60 per lb. (1200 yds. per lb.) \$.30 per 1/2 lb. tubes.
Perle 5, comes in all colors: \$.32 1/2 per 2 oz. tube. (2700 yds. per lb.)
Linen 18/2, comes in all colors; \$.75 per 1/4 lb. (2700 yds. per lb.)
Crochet Cotton, in all colors: \$.25 per 350 yd. ball. (1750 yds. per lb.)

Send for Thread Chart with samples of threads.

A HEAVY-TEXTURED COTTAGE CURTAIN

This pattern weaves up in the form of little squares about 2 inches in size as shown by the sketch at O. The curtain is suitable for cottage windows.

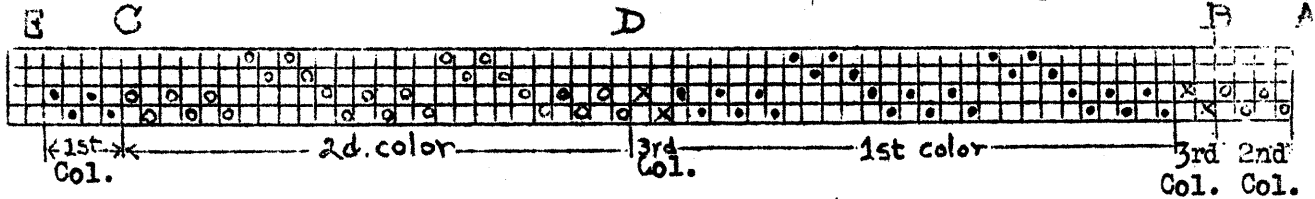

Materials

This curtain material is planned for coarse threads, such as carpet warp or crochet cotton. Three colors are chosen:

- 1st color, a, a background color: (white)
- 2nd color, b, a complimentary color or a color blending with first color: (tan)
- 3rd color, c, a dark or bright color used for accent: (red)

Note these colors shown in code in pattern draft. Thread at indicated places with these colors.

Warp Plan

- Width of warp: 31 3/4 inches
- Threads per inch: 12
- Total number of threads: 382

Threading Plan

Selvage A-B	twice	8 threads
Pattern B-C	56 thds. repeat 6 times	336 "
Pattern last time from B-D only		30 "
Selvage C-E	twice	8 "
		Total 382 threads

Weaving Plan

- F. Weave 4" tabby white for hem at bottom
- G. Two rows tabby with accent color
- H. 8 or 10 threads tabby, white
1&3
2&4 repeat
- I. 6 rows pattern as follows,
using red for pattern
white for binding tabby
2, 3, 4, pattern
1&3 tabby
2, 3, 4 pat.
2&4 tabby
repeat 3x
- J. 8 or 10 threads tabby, white
1&3
2&4 repeat
- K. 2 rows only tabby with accent color 1&3, 2&4
- L. 8 or 10 rows tabby, 2nd color, tan
- M. 6 rows pattern, same as above but with tan for tabby.
- N. 8 or 10 rows tabby, tan.
Keep repeating from G through N.
Finished material is shown at O.

All colors of Crochet Cotton and Carpet Warp are available at Creative Crafts. May we send you our thread chart? - 35¢. This gives lists of all types of weaving threads, their yardage, proper setting, practical usage, desirable threadings, etc.

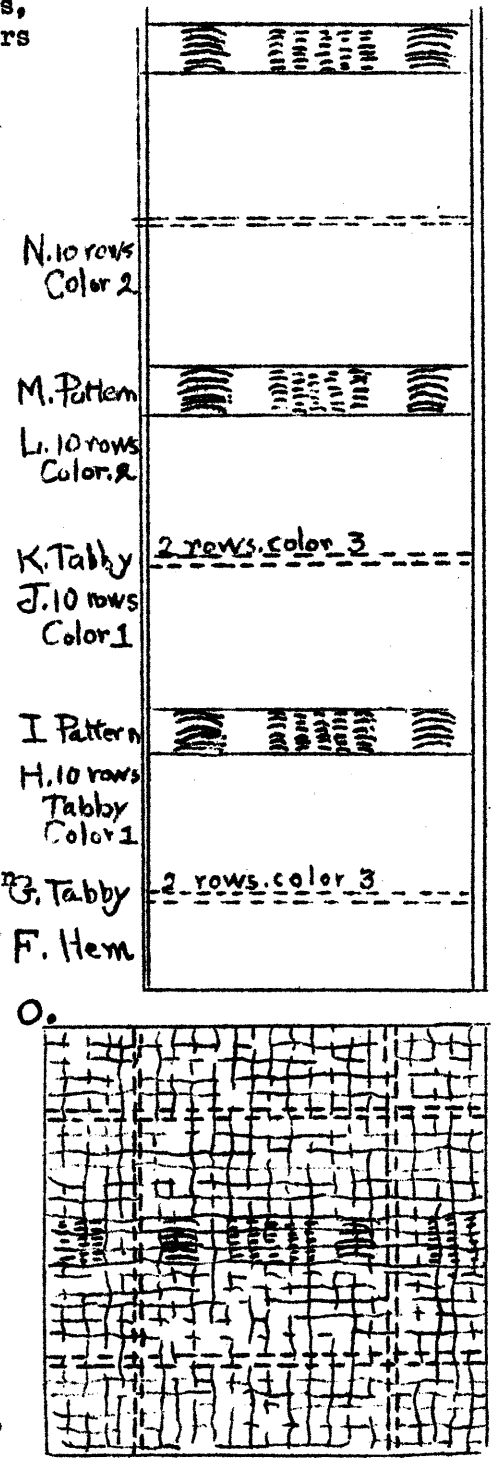

For those who enjoy an atmosphere of sunshine and cheer in the kitchen or dinette, we suggest a striped warp of several colors. To make a low-ceilinged room seem higher weave this in vertical stripes, using only one color for the weft. If you prefer a plaid effect, weave the weft pattern just like that of the warp, using the same spacing and the same colors when weaving as you used when threading the warp. If you desire a border at the base of your curtains, weave in the plaid pattern at the base of each panel, then proceed upward with only one color weft, which will prolong the design in vertical stripes only, as shown below in the sketch at right.

For materials you will need 14/2 ply white cotton(.95 per lb.) and for the colors, Perugian Filler(\$.22 1/2 per 2-oz. tube.) In the diagram at base of page, note a band of repeated colors,XY. This band gives the weaver a chance to introduce into the warp any of the colors of the room, even a series of bright rainbow colors in a flashing accent. The amount of material needed for 10 yds. of finished material 30 inches wide is: 1 lb. of white or a good background color in 14/2 ply or similar grist; and 1/2 lb. each of two other colors. Possibly other colors for accent.

PATTERN PLAN Choose 3 colors: a background color,1; a light color,2; a color complementary to this,3. For example, Color 1,white; Color 2,maize; Color 3, blue. The pattern consists of two motifs,the first, A-B, used only once at left selvage and once at right; and B-C, the center motif, which is repeated twice to form the main part of curtain. Reading from right to left in diagram at base of page, each check representing three warp threads:

WARP PLAN:
 Warp: 14/2 cotton or Perugian.
 Weft: the same.
 Size sley: 12 or 24 dent.
 Thds. per inch: 24
 Width in sley: 30"
 Total No. of Thds: 720.
 Weave as a stripe or plaid.

A-B----- 60 threads as follows: -----60
 color 3---- 6 thds.

- " 1----12 "
- " 3---- 3 "
- " 1---- 3 "
- " 2---- 3 "
- " 1----30 "
- " 3---- 3 "

B-C-----300 threads as follows:-----300

- color 2---- 3 thds.
 - " 3----33 "
 - " 1---- 3 "
 - " 2---- 3 "
 - " 3---- 3 "
 - " 1----72 "
- (117)

Section XY rainbow colors

- color 3---- 3 thds.
 - " 1---- 3 "
 - " 2---- 3 "
 - " 1---- 3 "
- (72)

(Keep on repeating 6x.Use any bright colors desired)

- color 1----72 thds.
 - " 2---- 3 "
 - " 1---- 3 "
 - " 3---- 3 "
 - " 2----27 "
 - " 3---- 3 "
- (111)

Repeat B-C again-----300
 Finish with A-B----- 60

Total for warp 30" wide 720

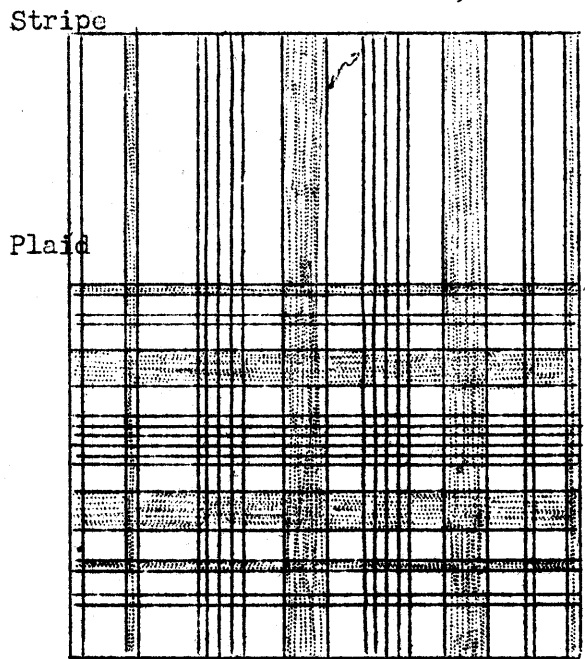
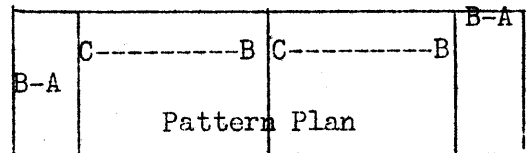

Read pattern chart right to left.



Here is a delightfully practical luncheon cloth or bridge cover with napkins, made on a narrow loom by sewing four small sections together. Each small section becomes a napkin when used alone. To make the complete set, one weaves eight squares, and sews four of these together for the cloth as shown in the sketch.

WARP PLAN

Width in reed:-- 16 3/4 inches
 Dents per inch:-- 30, 1 thd. per dent.
 Total no. of threads:-- 503

Kind of Thread: Warp, Umbrian warp;
 Weft, Ibid.

Colors: Two, a dark and light.
 Length of Warp for complete set:--5 yds.

THREADING PLAN in TWO COLORS

(This is only one of many plaid ideas which might be created.)

Section a-dark- 45 threads.
 Section b-light- 45 "
 4 Thds. bet.b&c- 4 "
 Section c-light- 270 "
 4 Thds. bet.c&d- 4 "
 Section d-light- 45 "
 Section e-dark- 90 "
 Total 503 "

WEAVING PLAN

Weave the four sections of the lunch cloth first. Weave each section such as Section A as follows:(Refer to numbers)

1. 6 1/4 inches dark thread, to be turned over into 3 inch hem.
2. 1 1/2 inches light.
3. 4 rows dark.
4. 9 1/2 inches light
5. 4 rows dark
6. 1 1/2 inches light
7. 2 inches, to be hemmed with fine hem for attaching to other pieces. This will leave 1 1/2 inches dark band next to center division, allowing 1/2 inch for hem.

WEAVING A SEPARATE NAPKIN

Before starting to weave napkins, cut wide dark band down to 45 threads, as shown directly below, at e.

10. 2 inches, dark	14. 4 thds. dark
11. 1 1/2 inch light	15. 1 1/2" light
12. 4 thds. dark	16. 2 inches dark
13. 9 1/2 inches light	

Weave sections A and B alike, then weave sections C and D backwards, starting with 7, 6, 5, etc. to bring wide band of weaving on the correct side.

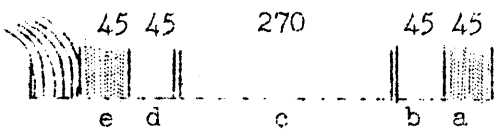

Warp for separate napkin

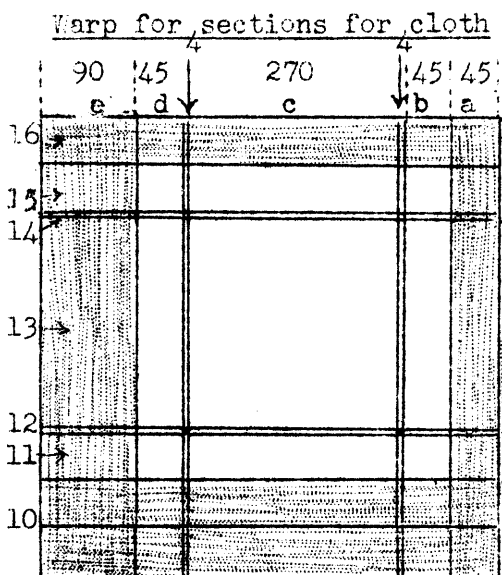

Warp for sections for cloth

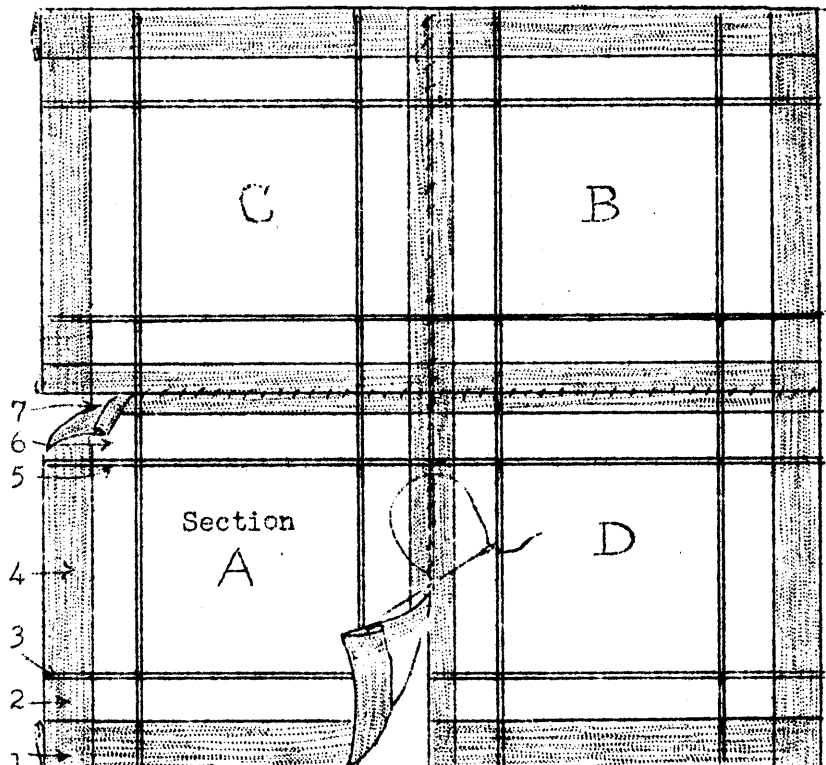

To weave a true Scotch Plaid design is great fun. A blanket of pure wool is such a satisfaction, for its users in the home must recognize it as a thing of usefulness and beauty. One never tires of the rich colors of an authentic Scotch Plaid, for they modify one another and add combination tones to the finished effect. A splendid book containing 95 such designs and published in Canada, is available at Cromaine Crafts for \$2.00. From this book we have chosen the two plaids below to make a car blanket or couch throw, measuring 40" x 50" when finished. Two throws sewed together will make a blanket 60" x 30".

MATERIALS: Warp and weft, a heavy homespun or Germantown, like enclosed sample.
Width in sley: 42". Threads per inch: 10 or 12. Total No. Threads:
for 10 per inch, 420; for 12 per inch, 504.

DESIGN: In threading a plaid design, one simply warps on the warping board according to the number of threads planned for each successive color. For instance, weaving from right to left across upper line of Douglas Plaid, - for the 16 green, warp the required yardage of 16 threads on warping board. Next, for 2 white, warp twice across board with white; then eight times with Black, twice with white, etc. all across one repeat of pattern, as far as vertical arrow. Then repeat design from right to left again. To weave in plaid form, follow same count for weft threads; see vertical plan, left.

Vertical Plan ↓

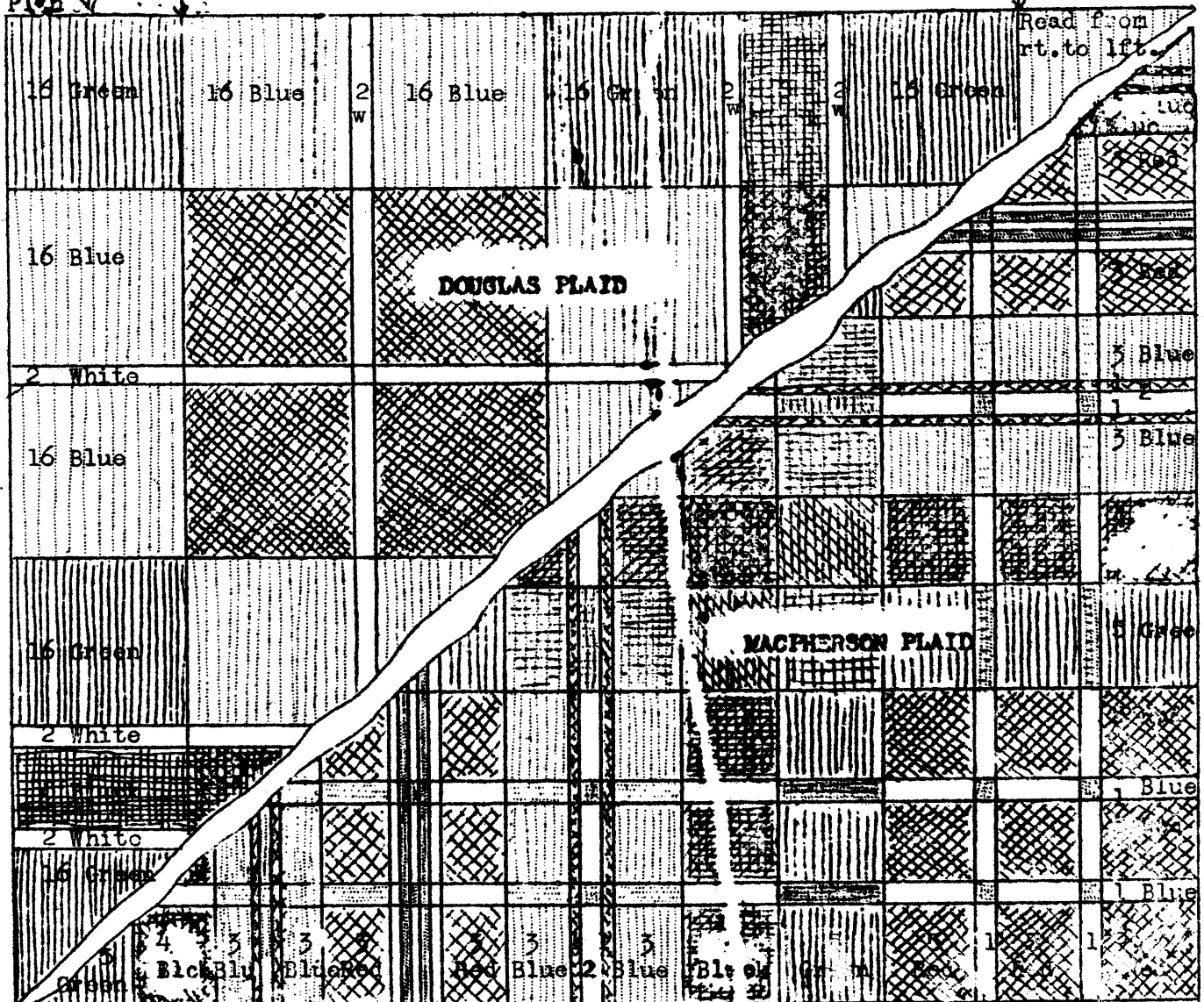

MACPHERSON: Read rt. to left. - 5 Red. 1 Blue. 5 Red. 1 Blue. 5 Red. 5 Green. 4 Black. 3 Blue. 1 Red. 2 Blue. 1 Red. 3 Blue. 3 Red. 1 White. 1 Black. 1 Red. 1 Black. 1 White. 3 Red. 3 Blue. 1 Red. 2 Blue. 1 Red. 3 Blue. 4 Black. 5 Green.

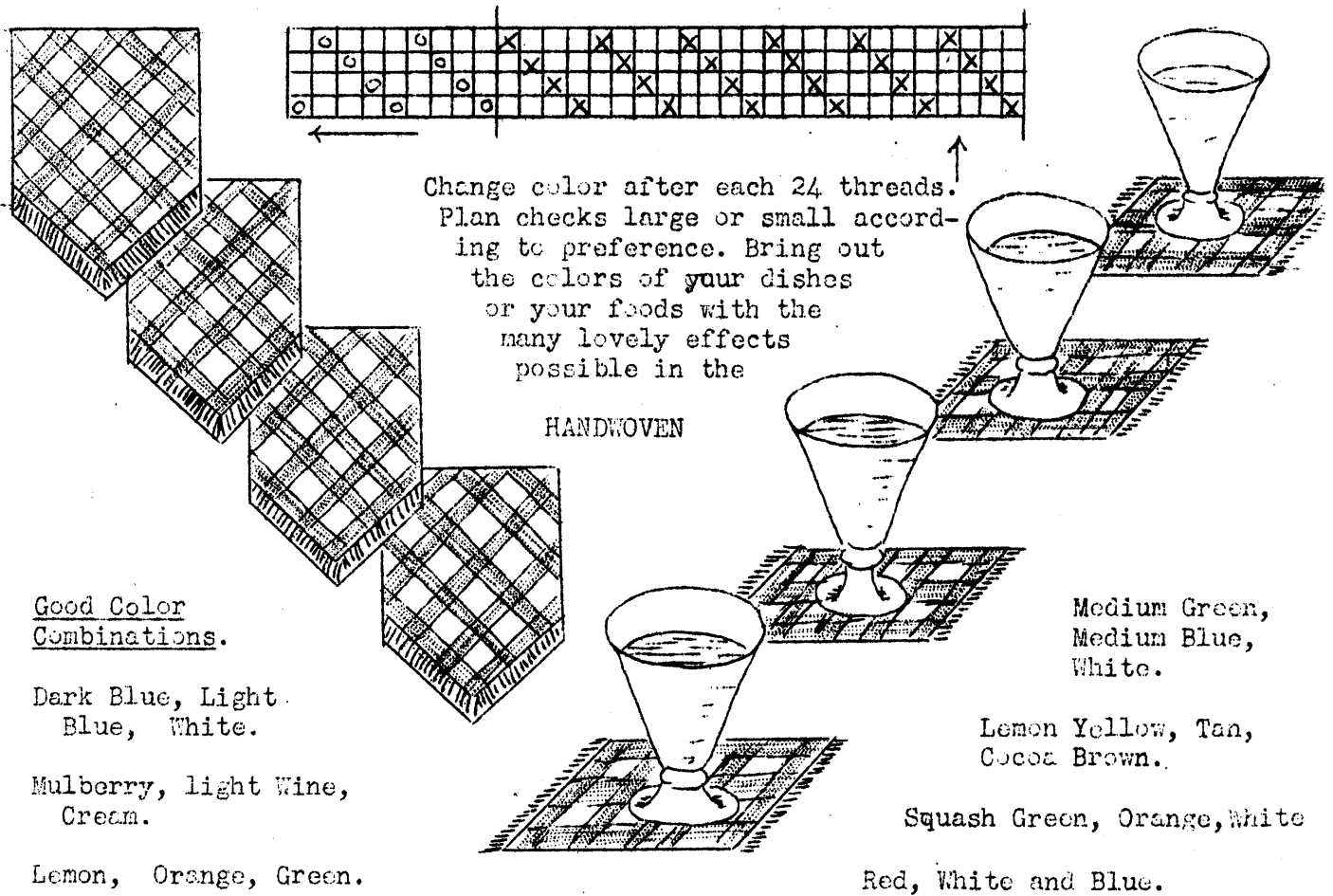

Call them what you will, use them as you please,-- these small color accents for the table are what most of us need. They serve many uses,-- for coffee tables, beverage trays, glass doilies, cocktail napkins. Bright with color, they enhance the beautiful colors which oftentimes appear in our foods, and which may be made the feature of any meal. There is red to match the cranberry, tomato and cherry; tones of gold and orange for peaches, apricots and grapefruit; greens for the leaf vegetables, lettuce, etc. If one considers the possibilities of making doilies to match the available flowers for table set-ups, there is no limit to the lovely things possible.

WARP PLAN for Doilies 6" wide.

Warp: Umbrian Weft: Umbrian
in colors in colors

Tlds. per in. 30 (or 32)

Width: 7" if 30 per in., shrinks down to 6".
6 3/4" for 32 per in., shrinks to 5 3/4"

Total No. of Tlds.- 216

Colors: Choose three, Dark, (D), Medium, (M),
Light, (L), such as Red, (D), Blue, (M),
White, (L). The check alternates with
first a block of red, then white, then
blue, then white. For just two colors
simply alternate red and white, etc.
The checks measure about 3/4" wide,
24 threads planned for each square.

THREADING PLAN

24 tlds. Red (D) For a softer
24 tlds. White (L) effect, use
24 tlds. Blue (M) Log-Cabin Plan
24 tlds. White (L) in our leaflet
Repeat 2x then No. 825. Woven
add 24 Red (D) at on 2-or 4-
end. Total- 216. harness loom.

DIMENSIONS OF DOILIES

For a square, weave doily 7" long,
with exactly same count for colors
as is in warp. For a longer piece,
weave 10" long, shrinks down to 9".

A car blanket is useful at any time of year. If it is woven in attractive plaids, it adds a perpetual touch of life and color to the car. If your loom weaves 32" wide, you may weave your motor robe in two sections measuring 40" X 27", and sew the lengths together along the 27" side, making the total measurement of robe 40" X 54". If your loom weaves 42" wide, weave your robe in one section measuring 54" long and 40" wide. If your loom is a 22" Utility Model, weave two sections 20" X 54", and sew them together along the 54" side.

Large plaid patterns are the most effective for blanket or robe, and you may choose soft blends of color or striking contrasts such as are used in Scotch Plaids. Two designs are given below.

Material: Weight of yarn as per enclosed sample, same for both warp and weft.
 Price of yarn, \$ _____ per lb.
 Amount needed for one blanket 54" X 40":

THREADING FOR LOOM 32" WIDE (Two strips 40" X 27")

Width in sley: 28"
 Dents per inch: 16
 Length of warp: 3 yds.
Total no. thds: 448

(Note: A 12 dent reed may be used, resulting in a softer texture. In this case loom 32" wide takes 336 thds; loom 42" wide, 492 thds. Loom 22" wide, 240 thds.)

THREADING FOR LOOM 22" WIDE

Width in sley: 21"
 Dents per inch: 16
 Length of warp: 4 yds.
 Total no. thds. 320

LOOM 42" WIDE (Two rugs 54" X 40")

Width in sley: 41"
 Dents per in: 16
 Length of warp 4 yds.
Total no. thds. 656

(However, the 16 threads per inch makes a good durable texture, and when it is washed, softens considerably. If your wool proves heavier than sample, use the 12-dent preferably.)

On both of patterns given below, one square of paper represents 2 threads.

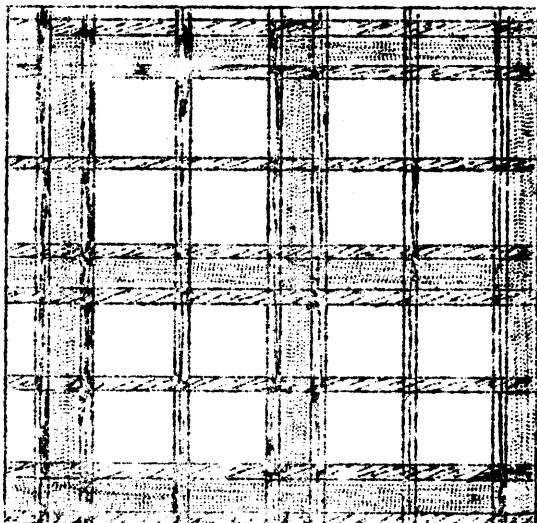

2 4 2 10 2 10 2 4 2 10 2 10 2 4

B. Pattern: Choose 2 colors, dark and light, and a third color, an accent.

8 dark 10 light
 2 light 2 bright accent
 8 dark 10 light
 2 light Repeat
 8 dark

A. Pattern: Choose 3 colors, a dark, medium and light, add one contrasting color.

2 thds. dark 10 thds. medium
 4 thds. light 2 thds. contrast
 2 thds. dark 10 thds. medium

Repeat

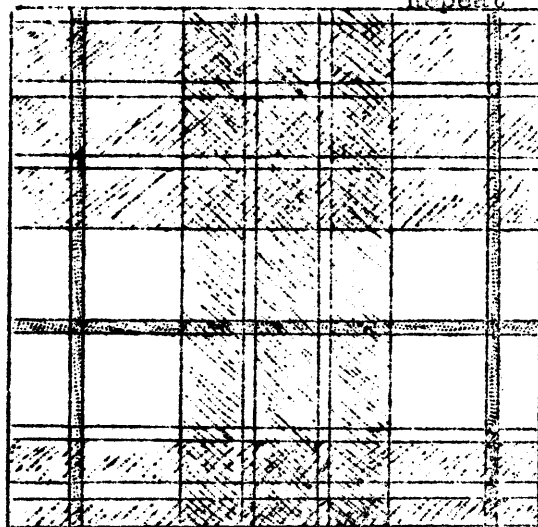

8 2 12 8 2 8 2 8 12 2 12

For a larger plaid double the number of threads in each group.

No pattern makes a more "fetching" necktie than the Colonial Log Cabin. Although this pattern looks intricate, it is so simple that it can be woven on a two- as well as a four-harness loom. Its effect is even more subtle than many four-harness patterns. The trick lies in an alternation of light and dark threads in the warp, and the same in the weft. By combining two unusual shades, one may produce a most beautiful balance of blocks, with each color predominate at intervals. This same pattern is excellent for draperies, (See Leaflet No. 825) and with a coarse carpet warp will produce an effective block design for a rag rug. One nice thing about the pattern is the ease with which the pattern blocks may be changed to be of any size.

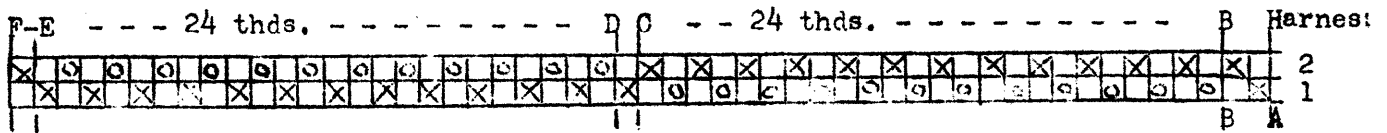

Above: Two-harness Threading. Below: Four-harness Threading.

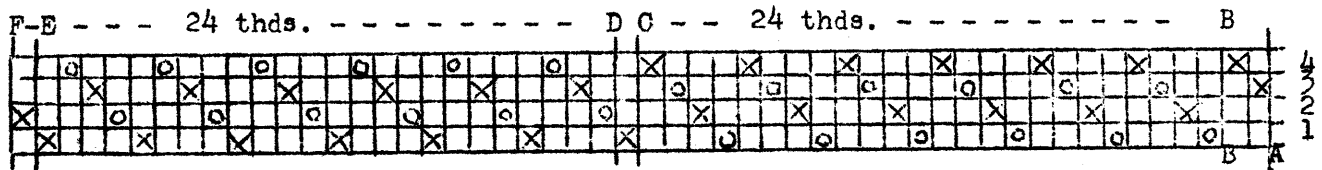

WARP PLAN.

Warp and Weft: Bernat's Febri Yarn
Threads per inch: 24
Width for a necktie fabric measuring 19"
wide when shrunk: 20 1/4".
Total No. of Thds: 498

THREADING PLAN:

Choose two contrasting colors of thread.
Warp two at a time, a dark and a light together, each coming through a separate screw-eye to prevent twisting.

- A-B: Start with two threads dark, once- 2
 - B-C: Warp a light and a dark together, repeat 12 x - - - - - 24
 - C-D: One dark alone, (drop other thd.) 1
 - D-E: Warp a light and dark, 12x - - - 24
 - E-F: One dark alone - - - - - 1
- B to F, Total 1 repeat 58
- Repeat from beginning of pattern at B through F, 9 times, total- 496
- Add two starting threads, A-B to above- 2
(merely add figure 2, do not warp A-B again) Total of all threads 498

WEAVING PLAN:

Use a shuttle of each of the colors:
To weave a block, alternate: light, dark, light, dark, etc. for 24 shots, then add one dark shot. Keep on repeating, making weft checks same size as warp checks.

EXPLANATION OF THREADING.

In threading, one alternates the colors of warp threads over a set distance, such as B-C. The number of threads in this span determine the size of a block. By adding an extra thread in either one of the colors at regular intervals, the colors change harnesses. (See extra dark thread, C-D. The harness that before carried dark threads, now carries light threads.

In weaving, when harness 2 is raised, it is apparent that dark warp threads will show from B to C, and light from D to E. This produces a dark block next to a light block warp-wise. In putting in the weft one carries out the same alternation of colors for a set distance, then throws in an extra thread in either color, to shift the blocks weft-wise. The result in a subtle alternation of blocks in a check arrangement.

To make smaller blocks in the fabric, simply use fewer threads in a span, such as from B to C. 12 threads from B to C, and from D to E, would make checks 1/2".

Note: For further information about making handwoven neckties, directions for sewing, etc. send for leaflet No. 954.



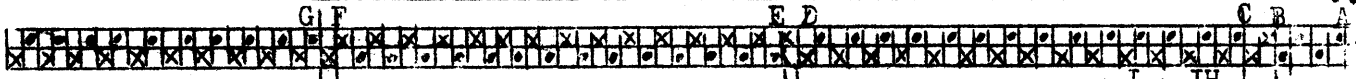

This weave, altho tabby, has the effect of small squares of design,- a quaint pattern for rugs,runners, table-linen. The threading may be on a two-harness or four-harness loom. Two contrasting warp colors alternate in such a way that all the darker threads show on the up-shed at intervals, causing a dark woven square, and in between the light threads show up, causing a light square. In the draft, the dark threads, see dots, are used for the border from A to B. This may be as wide as desired, appearing when woven as at H. From B-C, two light threads, see crosses, are used to form a dividing line. From C-D, the light threads are threaded on the first harness and the dark threads on the back harness. By adding an extra light thread at D, we throw the dark thread on the first harness and the light threads on the back harness. In weaving, when the back harness is raised the result is a block, CD, dark, and a block, EF, light. We can thus alternate blocks of any size. To thread this pattern on a 4-harness, simply run the alternating colors through the four harnesses as shown at sketch, upper right, K.

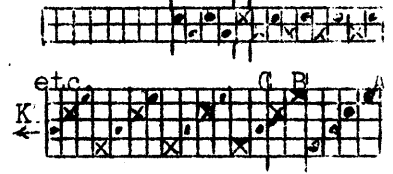

WARPING: Choose two contrasting colors. Instead of changing for each length, warp a dark and a light together, each color going thru a separate screw-eye to prevent twisting.

- A-B, Border: Warp two dark threads together, repeat A-B 8x, total--32 thds.
- B-C Warp two white threads separately here-----2 "
- C-D Warp a light and dark together, 14 prs. of thd----- 28 "
- D-E Warp one extra light thread----- 1 "
- E-F Warp a light and dark together, 14 prs. of thd----- 28 "
- F-G Warp one extra light thread----- 1 "
- Repeat from C-G inclusive, (total of 58 thds) to desired width, then:
- G-H, Last time, same as C-D ----- 28 "
- H-I, One extra light thread ----- 1 "
- I-J, Border, Warp two dark threads together, repeat I-J 8x, total- 32 "

WARP PLAN FOR PILLOW AND RUNNER:

Material: Use Perugian Filler for both warp and weft.
 Width in sley: 19 1/4"
 Thds. per in.: 20"
 Total No. Thds. 385
 In following above warping plan repeat c-G 5x.

RUG 24" WIDE

Warp: Carpet
 Weft: Fine cut rags.
 Width in sley: 24"
 Thds. per in. 16
 Total No. Thds. 385

CURTAINS

Warp and Weft: 20/2 ply
 Width in sley: 32"
 Thds. per in. 30
 Total No. Thds. 960
 (Repeat c-G 15x)

WEAVING: To weave a solid dark section with faint vertical stripes, weave with the darker color only, plain tabby. To weave a solid light section, weave with light only. To weave pattern into blocks use two shuttles, one with light, the other with dark thread. Alternate these for as many shots as there are threads in one block of draft. For instance from C-D has 28 threads, -so weave dark, light, dark, light, for 28 shots. Then add an extra light shot after a light, and this will throw the dark up where light was before and vice versa; this gives a dark block next to a light one. Weave 28 shots thus, then run in an extra light and continue. Weave a section of alternating blocks, as at L, or continue with one thread only for columns as at M, also O in curtain sketch.

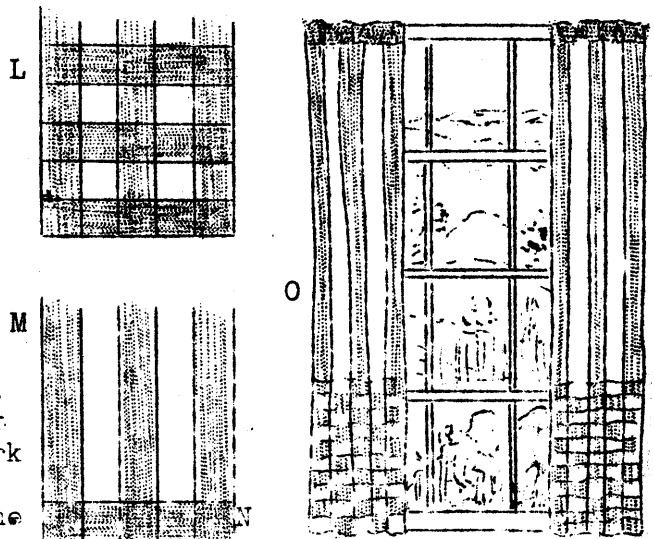



Design for Striped Lines in Boilies. Use heavy texture-line at 1. Inter vals.

Overcast hemming and ending edges while doily is on loom.

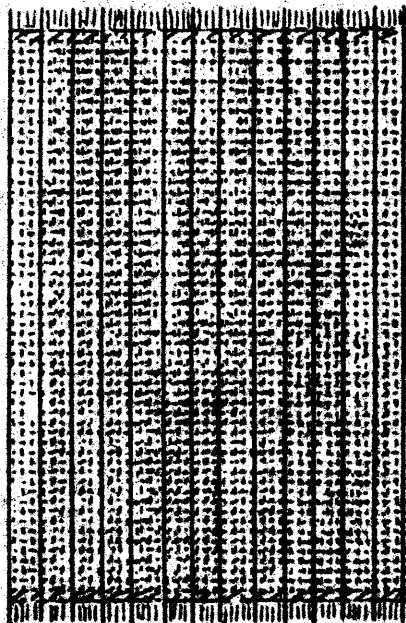

Weave Curtain Border 7" wide from Base.

EFFECTS IN PLAID DESIGNS

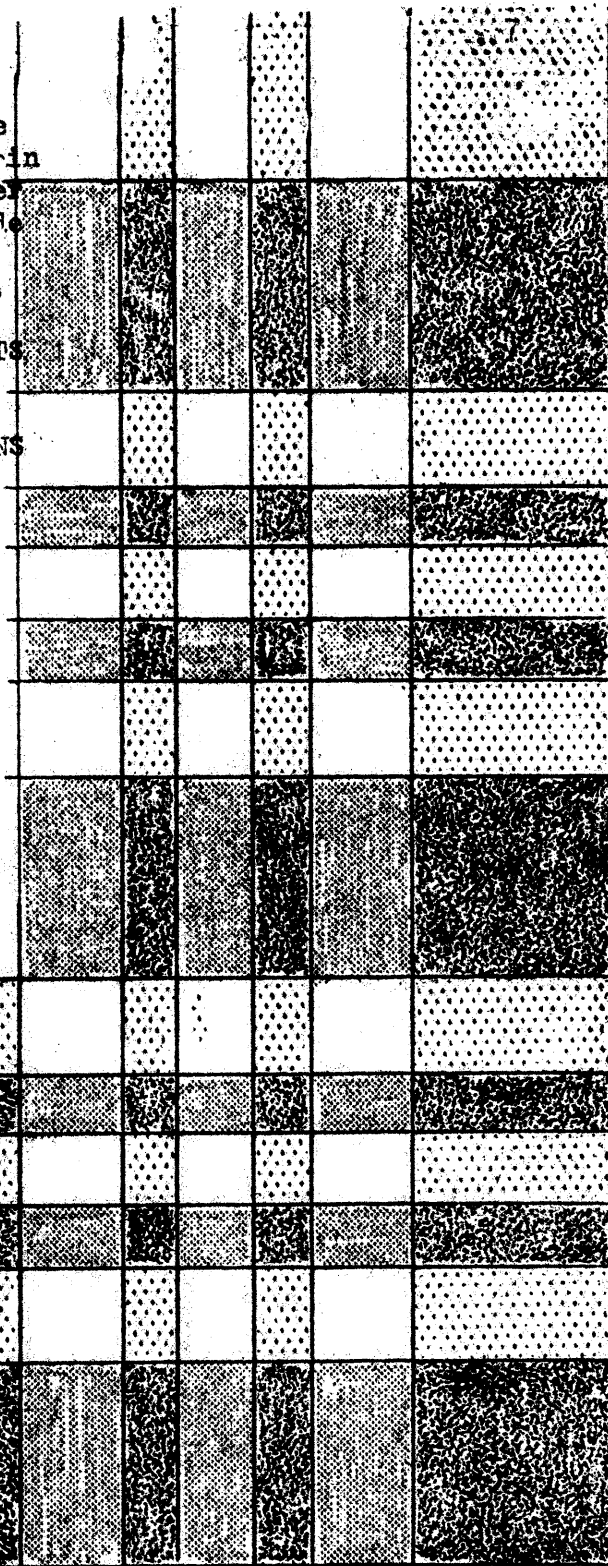

L↑

Corner of Naphin, used by George and Martha Washington.

(Design of Naphin, 1/2 actual size.)

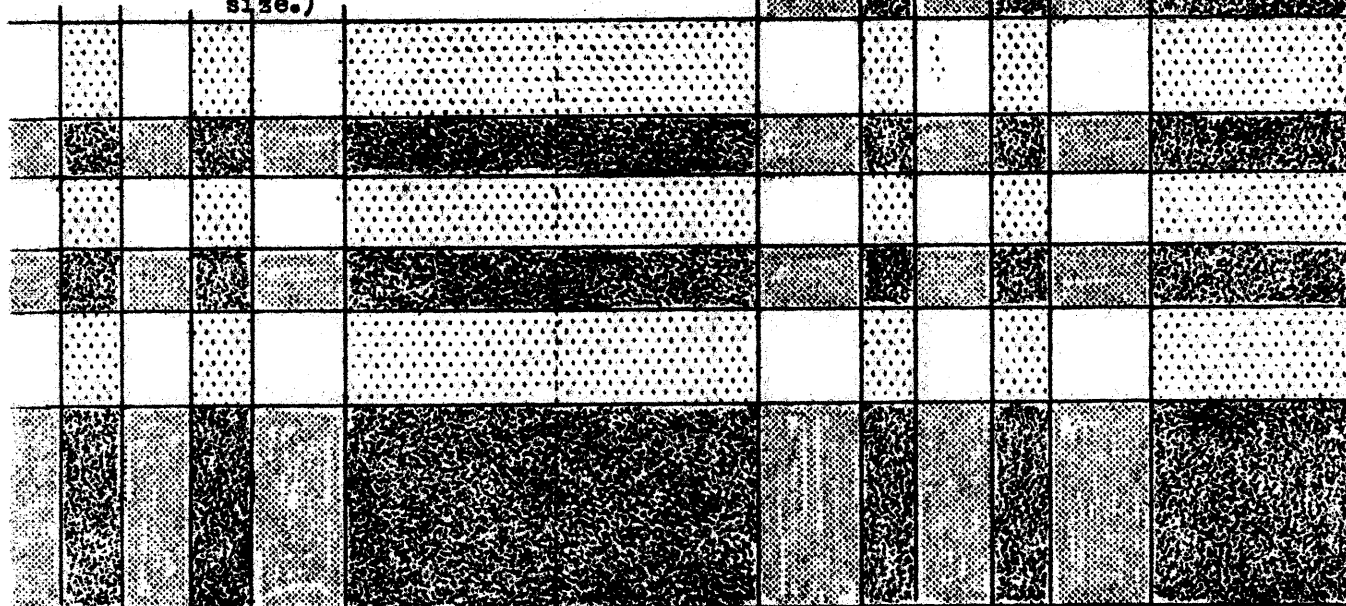

Above: Plaid Design for Cottage Curtains; Striped Warp in a Color and White. Below: Plaid Design for a Table Cover to go with Naphin above.

Warp: Border at Edge: 1 1/4" main color, 1 heavy line; 3/8" plain; 1 heavy line; 2 1/2" plain; - Repeat as desired. Finish with 1 1/4" plain, main color at other edge.

Imitation Summer and Winter Rug or Mat
Written on Two Harnesses

b 724

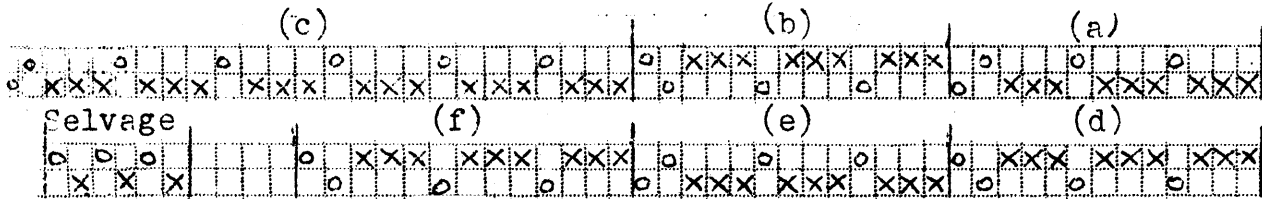

Here is a rug or mat pattern for a 2-Harness loom that will produce an effect very similar to the 4-Harness S & W. For the best results, the warp should be in two colors, as indicated by the x's and o's of draft.

Warp Plan for a Rug:

Warp: 2/4 Carpet Warp
Thds. per inch: 12
Width in Reed: 28 in.
Total Thds: 336 Threads.

Threading Plan for Rug:

Thread each section in order as given on the draft, beginning at right side and progressing to the left:

Section a, - - - 13 threads.
" b, - - - 13 "
" c, - - - 25 "
" d, - - - 13 "
" e, - - - 13 "
" f, - - - 182 "

Reverse from here, threading each separate section from right to left, but taking the sections in reverse order: Thus, thread (e) next, 3 notes on H.1, one on H.2, etc. then thread (d) starting 3 notes on H.2, one note on H.1, etc.

e, again- 13
d, " -- 13 Add threads
c, " - 25 for Selvage
b, " - 13 as desired.
a, " - 13
Total - 336 Threads

Warp Plan for a Doily With Border:

Warp: 24/3 Cotton or 20/2
Width in Reed: 13 1/2 inches.
Thds. per inch: 30
Total Threads: 401

Threading Plan for Doily:

Thread in same way as given for Rug, but repeat Section (f) 19 times instead of 14 times, making a total of section (f) at center of 247 thds. and a total overall of 401 thds.

The weaver may likewise adapt the pattern to various warps and widths by repeating the center unit, (f) to more or less repeats.

Weaving Plan for Rugs or Mats:

1st Section, X. Choose two colors, A and B. Weave: H.1, color A.
H.2, color B.
Repeat these 2 rows 6 to 10 times to form a corner square.

Section Y. Weave H.1, color B.
H.2, color A.
Repeat these 2 rows 6 to 10 times to form square next to corner.

Section X, 1. Repeat Sec. X 25 to 30 times, see sketch.
Section Y, 1. Repeat Sec. Y, 6 to 10x.
Section X, 2. Repeat Sec. X, 6 to 10x.
Section Y, 2. Center of Rug. Repeat section Y as many times as desired to make a square or oblong center.

Four-Harness Threading:

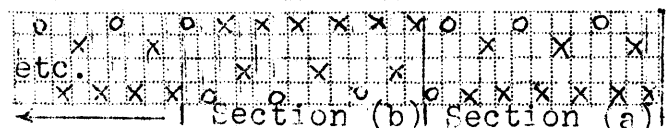

Four-Harness Weaving: In place of H.1 in above directions, weave Hs. 1 & 3. In place of H.2, -2 & 4.

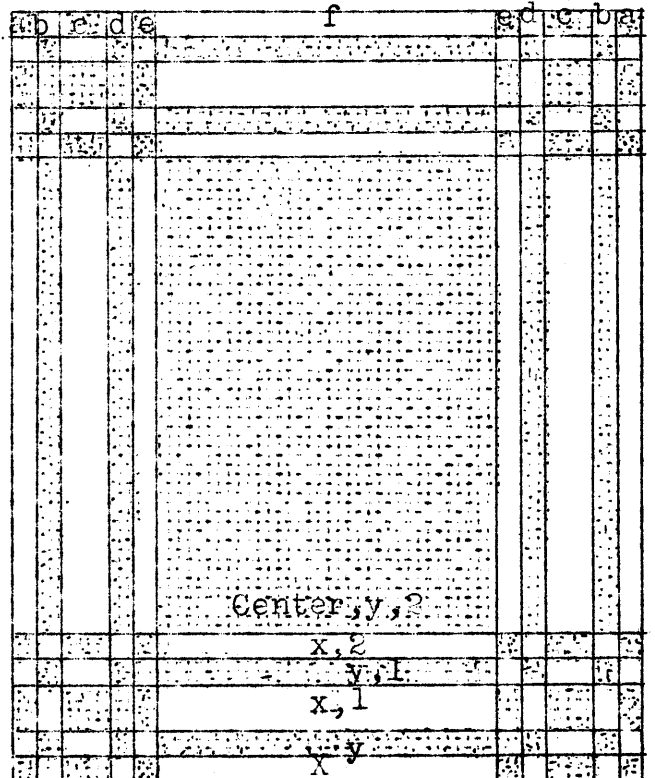

The log cabin, mountain home where so many old-time weavers once worked on large floor looms, preserving for us the precious colonial patterns that are a part of America's great inheritance,- what design could be more loved than this, by the weaver of today?

DIMENSIONS FOR RUNNER OR TOWEL: Finished towel measures 24" X 13". Weave from dimensions at lower right of diagram.

COUNTING THREADS: On this pattern, each square of the graph paper represents two horizontal and two vertical threads of the tabby background. See enlargement of squares below.

DESIGN: At base of house, three tabby rows in color are woven: one black and two colored. Make shed, then at center of towel lay in black thread 3 1/2" long. In same shed lay tabby. Change shed, lay in one row of the colored thread, put tabby in same shed (colored thread is 3 1/2" long, tabby all the way across.) Change shed and put in second colored thread followed by tabby.

Begin design of house, tree, etc., with separate soft colored pattern threads, at A,B,C,D,E,F. Trunk of tree is enlarged at G, bottom of page. Make shed, lay in pattern thread,G-H. Lay binding tabby thread in same shed,XY. Now change shed, lay in second pattern row through shed opening,HI, and lay tabby in same shed,YZ. Continue following pattern in this way.

After making shed for each row, look all across design and be sure that you have laid in threads for all parts of design at same level., i.e. for squares B,C,D,E,F. Have all inlaid threads running in same direction. This makes it possible to make a simple joint between colors, as at J, shown enlarged at K. Do not let adjacent colors pass around the same warp thread but around adjacent threads, as at K. The tabby thread will hold the cloth firmly together.

Clouds

COLORS: Choose three colors that go well together and divide as follows:
 Color 1(dark) Use for wide colored towel border at base of towel; two rows of color below house; roof of house; top of tree.
 Color 2(A middle tone, bright) Use for chimney, window, bush.
 Color 3(Contrast to Color 1) Use for bright rows of border; side walls of house.

Clouds may be blue, lavender, pink; chimney smoke, black; heavy lines at sides of roof and base of house, black.

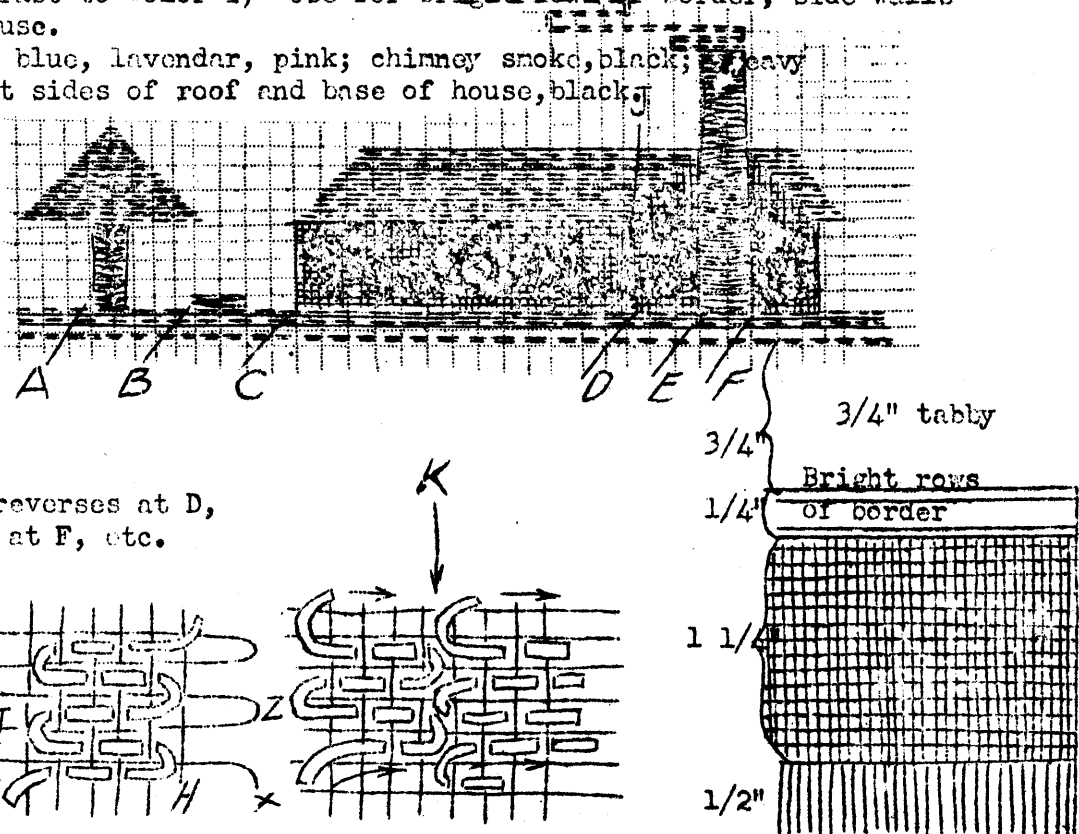

Thread C-D reverses at D,
 DE at E, EF at F, etc.

SPINNING WHEEL MOTIF IN FINGER-WEAVING TECHNIQUE
(INLAID TYPE OF DESIGN)

A spinning wheel as a guest towel motif, or used at the end of a table runner or tray cloth, makes a quaint interesting touch quite in character with a weaver's fancy. And of all the wheels that have at some time helped in making the world go round, - we must honor the rhythmic whirr of the spinning wheel, responsible in days gone by for the making of all thread.

DIMENSIONS OF TOWEL OR RUNNER: The completed towel measures 24" X 13" plus fringe. Weave as at lower right, with 20" between towel borders at ends.

COUNTING THREADS: On this pattern draft, each square of the graph paper represents two horizontal and two vertical threads of the tabby background. For instance for one section of inlaid weaving marked (A), the pattern covers two squares from left to right or four warp threads. These are shown enlarged at lower left of page.

WEAVING SPINNING WHEEL: To weave actual pattern, begin at corners shown by arrows with separate pattern threads, as at A,B,C. Pass pattern threads through a regular shed, and they will pass under one warp thread, then over and under as shown. For putting in tabby thread, do not change shed, but lay in against pattern thread, as at DE. (Treat designs at B and C the same but start at corner marked by arrow).

For 2d row of pattern change shed, lay pattern in reverse direction, lay tabby FF in same shed. Weave back and forth for 3 or 5 rows. An uneven no. brings thd. to opposite side to start, G, and ready for next part. If next part of design were at X, you would weave an even no. of rows. When thd. does not come out right, cut and start new thread. Continue to next square at H, etc. Look all across design and be sure that you have laid in all threads at this level.

Colors: Make wheel, stand and bottom border same color. Make flax, spindle and rest of border, light color of thread, tan.

Make treadles and bottom line under wheel, black.

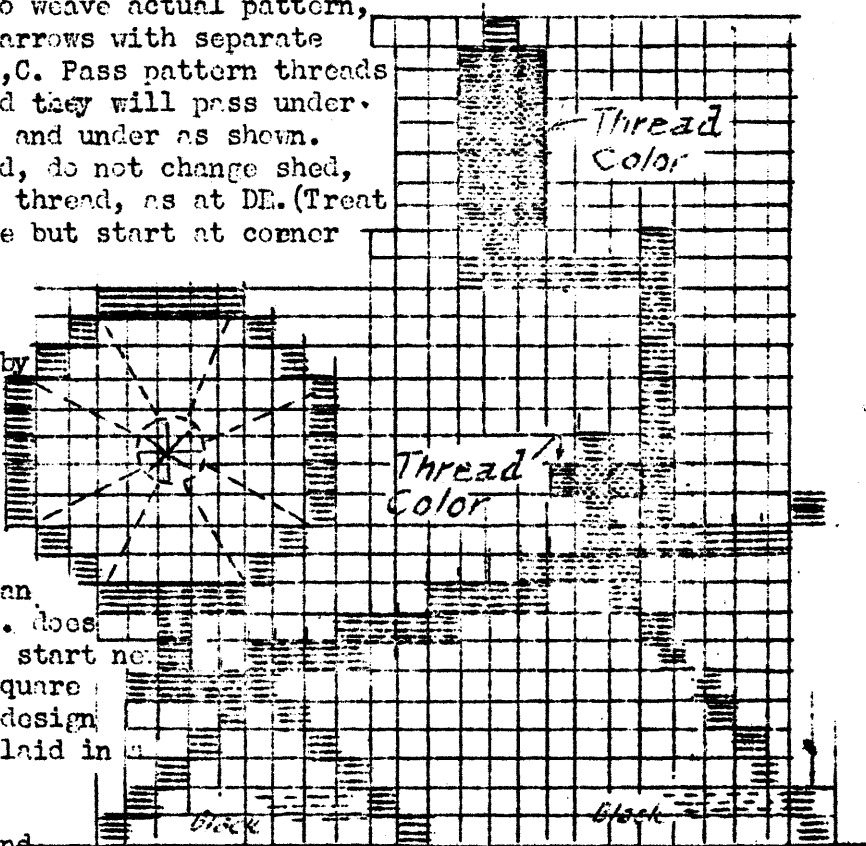
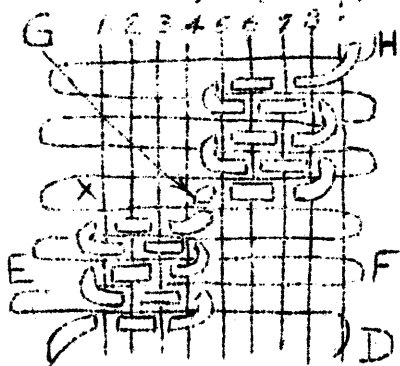

weave $\frac{3}{4}$ " Tabby B

Two rows bright color
Two rows white tabby
Two rows bright color

Weave $\frac{1}{8}$ " color band at bottom of towel

Leave $\frac{3}{4}$ " unwoven for fringe, and trim down to $\frac{1}{2}$ " inch

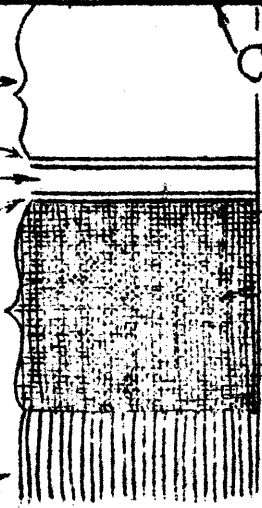

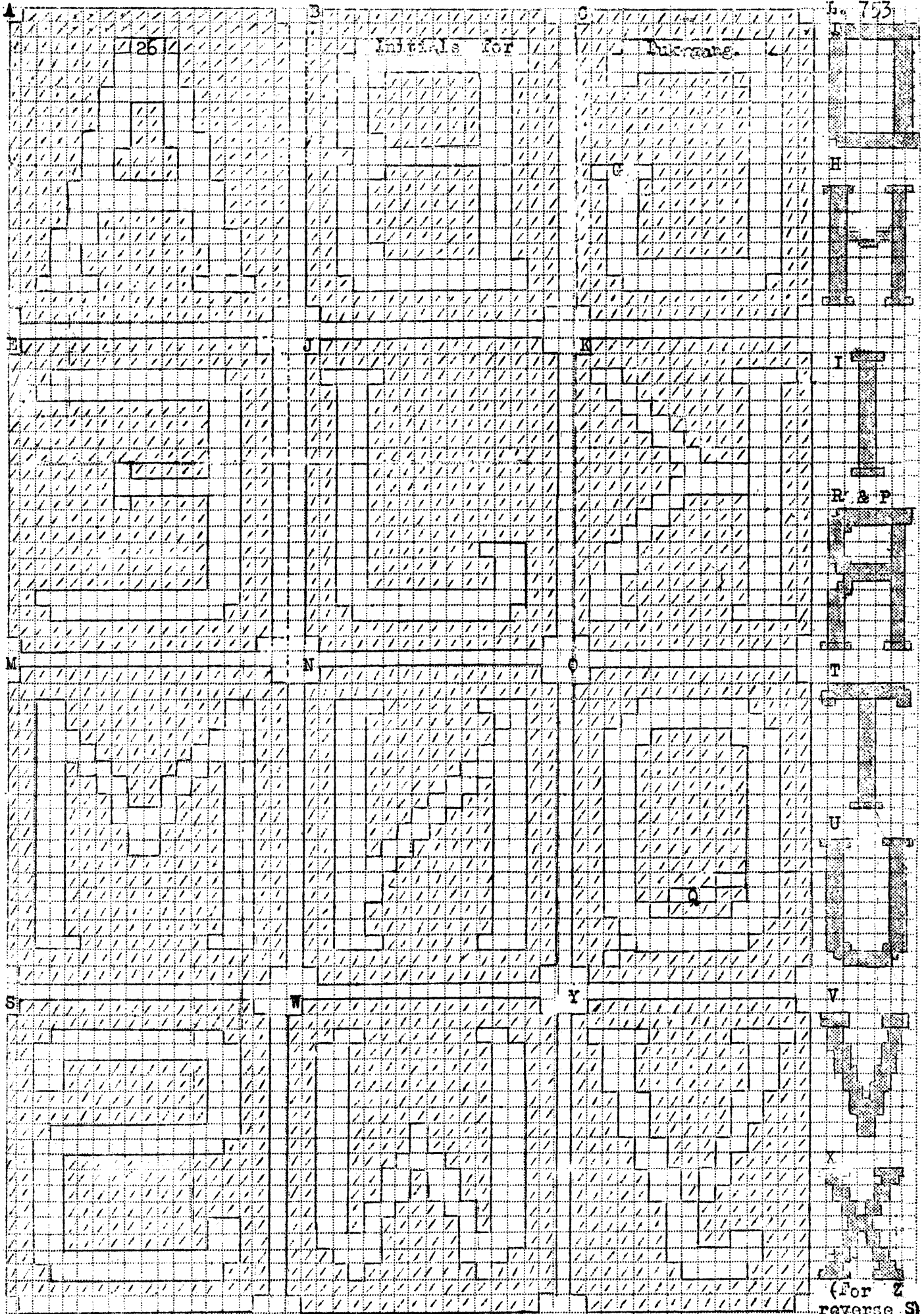

(For reverse S)

In Dukagang, L. 750, all monograms are woven backwards on wrong side. In above page, make F from E; G from C; L from J reversed; P from R; Q from O (Creative Crafts, Guernsey, Pa)

"Laid-in Weaving" refers to the laying in of design threads through a shed between the regular tabby rows. These threads show up against the plain weave background and are heavier than the binding thread or tabby. They extend for the design space planned only

"Italian Laid-in" is characterized by designs in gay colors, the product of a color-loving race living under clear blue skies in sunny Italy. Their imported towels or runners sell well because of attractive borders with touches of Laid-in; birds, flowers, etc. The charm and beauty of the weave lies in the fact that the design threads, in passing from row to row, leave small loops of thread outlining the design at the edges, and at these points the colored thread appears unusually bright, uncovered by tabby. This is considered the right side of the design. The design thread may even skip a space. (Row 4).

SUITABLE DESIGNS: Designs for this type of Laid-in should be fairly simple and not too broken into parts, for this requires extra pairs of design threads. No. 1, the Xmas tree below, is the simplest. Nos. 2 & 3, the pot of flowers and the pitcher, need a second pair of threads at the arrows. No. 4, the tulip, has a change of color at its flower center, so 3 pairs of threads are necessary, see 3 arrows. A very small interruption may be skipped over in weaving, as in No. 5, the rabbit, but this covers the light area, and makes it better to use the other side for the right side. This is possible, but not so effective.

METHOD OF WEAVING: The laid-in design threads are always put through the same shed, i.e. they always show between the two same warps, and a regular texture in columns results. An even number of tabby rows must follow each design row, usually two rows, but 4 or 6 rows are possible, making a more spaced design. For each square of design in check pattern, such as No. 2, allow two warp threads up and two down, (or more if desired). Weave enough plain weave for base of design. Then follow steps below:

- Step 1. Open 1st shed, (such as Hs. 1 & 3) Weave tabby through, fine thread. Now lay in design threads from opposite sides, through same shed, as at A.
- Step 2. Change shed to 2d shed, (such as Hs. 2 & 4) Weave 2d tabby, Row B. Change shed. Weave 1st tabby again, Row C. Do not change shed. Leave for Step 3.
- Step 3. Carry design threads around sides. Weave them through this shed. (Repeat 2 & 3)

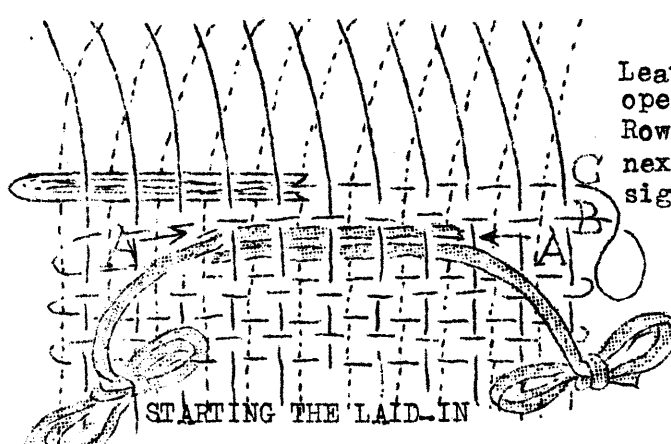
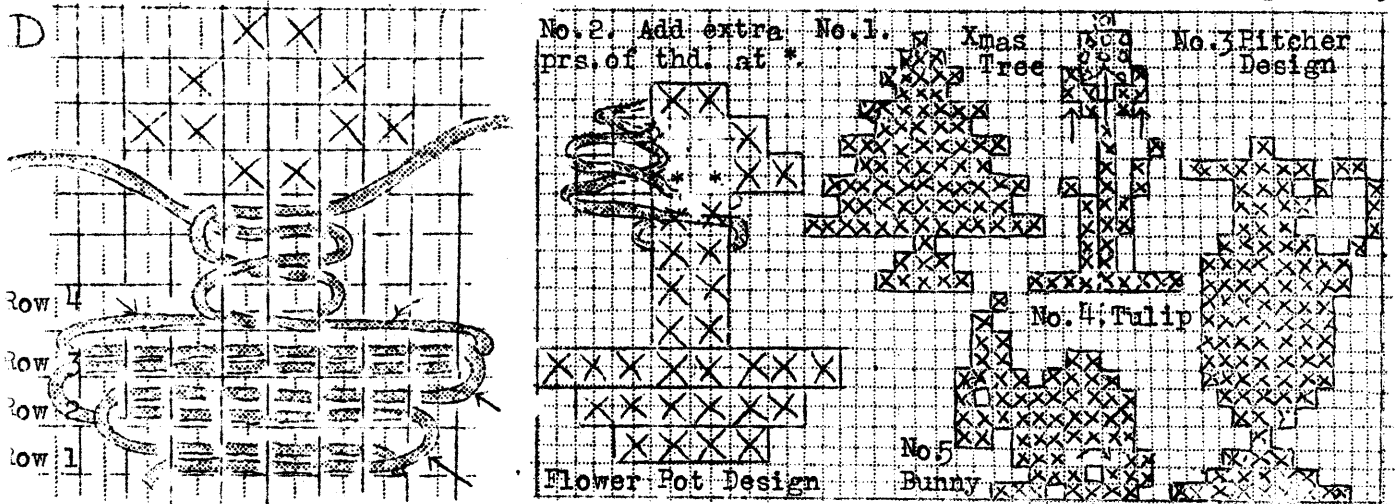

Leave Shed open after Row C for next design row.

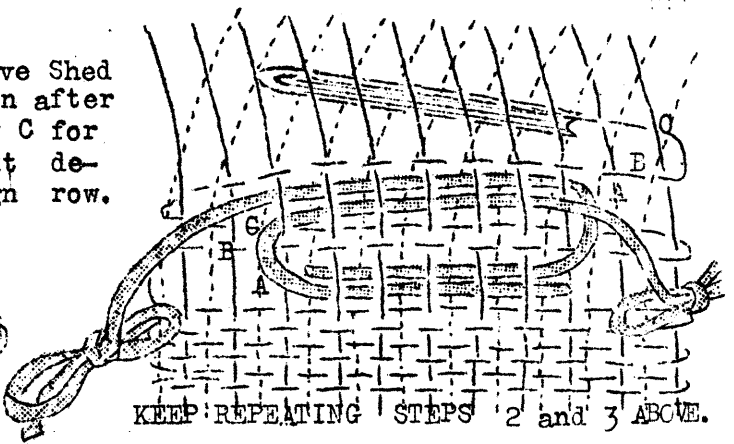

Motif  represents a dark earth color.

Motif  represents a leaf green.

Motif  represents the main flower color.

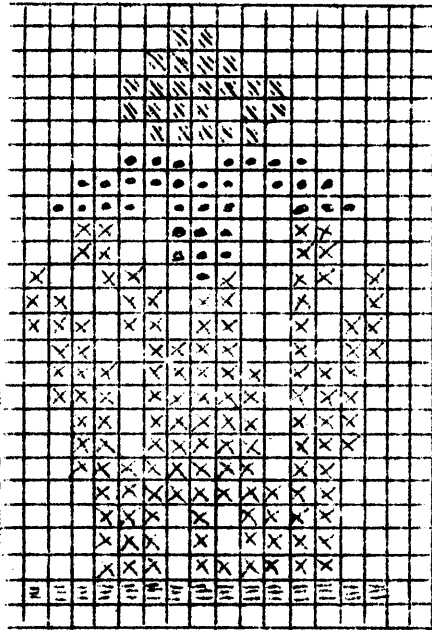

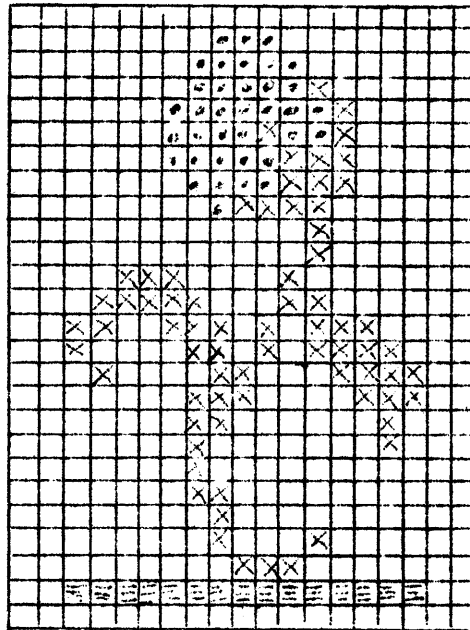

IRIS

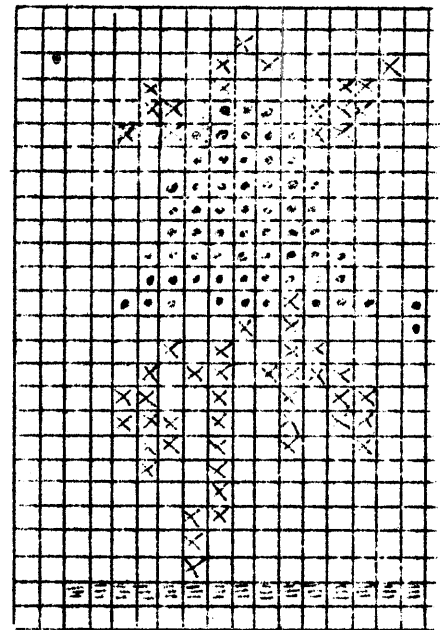

ROSE



CANTERBURY BELL

Choose bright colors for the two flower tones  , and  .

TULIP

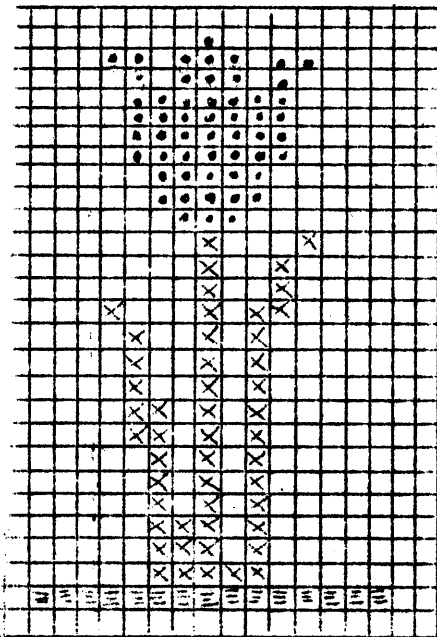

COLUMBINE

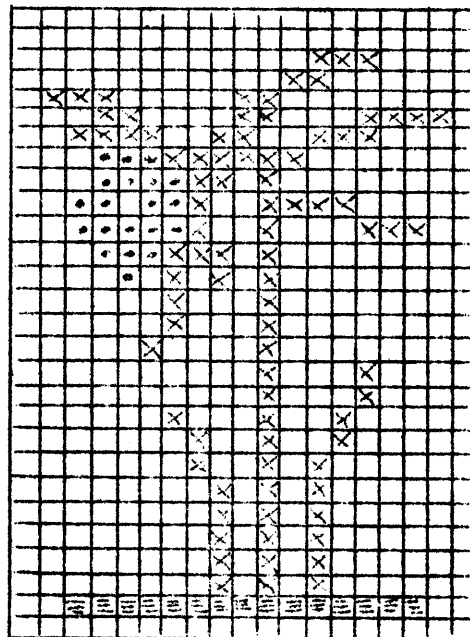

POPPY

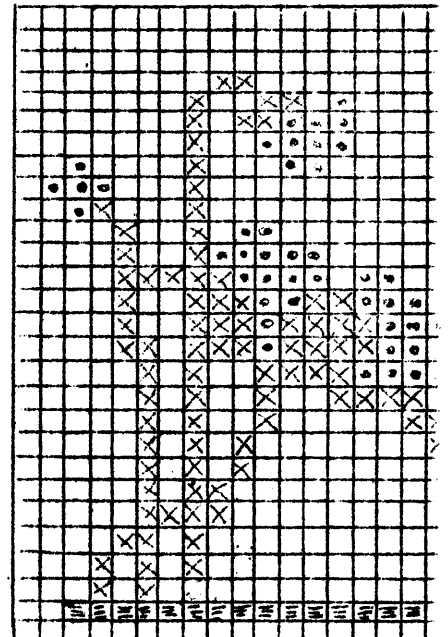

These designs have been especially planned for the technique given in leaflet No. 750, Finger-Weaving, also known as Dukagong. Each square of the pattern represents the desired number of warp threads. With a warp set 30 to 32 threads per in., let 4 threads of the warp be regarded as a square with 2 threads for the line between squares. The weaver will then pass under four threads and over two to make the design. This will make the size of each square about 1/6 in. If the warp is set further apart, i.e. 20 to 24 threads per in., allow three threads for each square, with one thread between squares, or pass the pattern thread under three and over one.

DEFINITION OF LAID-IN WEAVING: Laid-in weaving refers to the laying in of design threads across a warp in addition to and along-side of the regular tabby weft threads. The continuous tabby weft going from selvage to selvage is called the "shuttle thread" and the design thread that travels only back and forth between the design places, is called the "bobbin thread". The latter should be heavier than the former. Laid-in weaving may be done on either a 2- or 4-harness loom. In each row, the tabby thread is laid in first followed by the design thread through the same shed, but only for the distance indicated by the cross-stitch pattern.

The type of design used is that found in simple cross-stitch patterns,-- motifs of flowers, fruit, trees, scenery or conventional or modernistic designs. This technique works up well into wall panels, border designs for drapes or towels, doilies and mats.

PLANNING DESIGN ON CHECK PAPER: Lay out design as shown at A in the Dogwood diagram on next page. Use different marks for different colors,-- for instance x for green; / for white; = for brown. Simplify design so as to avoid too many thread changes; for whatever part of design stops, as between petals, (while tabby continues), the design-thread must either come out of the warp for interrupted space, then go under it again when check design resumes,-- or else one must use a new design thread altogether. In the Dogwood pattern given here, note how the petals are planned as all-over surfaces, and the design thread may pass from side to side without interruption.

In our sample Dogwood design, there are two rows of design weft for each check on the paper, and each check also covers the space of 2 warp threads. The continuous tabby thread is shown in sketch at lower left, G-H, while the heavier design thread weaves for a limited space, J-K. Where changes of color show on the check design, each color goes as far as the adjacent color, but does not overlap with it. Two adjacent colors therefor reverse around two warp threads that are adjacent, and not around the same warp thread, see arrows.

MEASURING THE DESIGN SPACE: Allow a certain number of warp threads for each check of paper. In sample design each check represents 2 warp threads. In the first row of the flower petal at furthest right, marked E-F, the design covers five checks, or 10 warp threads. When the shed is made there are 5 threads up and 5 down. So the number of warp threads visible is the same as the number of checks shown here on the paper. This type plan is simple to follow.

PLACING DESIGN ON FABRIC: Measure how far from the edge you wish the design. Then count number of warp threads across design. In the Dogwood design, from left to right side covers 50 checks or 100 warp threads, see C-D. Therefor if warp is set at 30 per in., the design will cover $3\frac{1}{3}$ inches. Knowing the size, you can figure where to place the first row.

WEAVING THE DESIGN: Select floss or Perle for the design thread, for this will fill in the spaces well. On a fine texture warp, such as 20/2 set at 30 or 32 per in., a good design thread is Perle 5, 10/3 cotton or crochet cotton. For a coarser warp, such as 12/3 or Perle 10 set at 20 or 24 per inch, use Perle 3 or Perle 5 doubled for the design thread. Floss or 6-strand cotton are excellent for design thread.

The method of weaving is shown in sketch at lower left corner, G-H, etc. First weave the regular tabby row using thread for tabby about the same size as the warp,-- this row is marked G-H. Now in same shed lay in design thread across 12 warp threads, or under the 6 warp threads that are raised. This would be represented in your cross-stitch or check paper design by 6 checks, (2 warp thds. per check). Beat tight with beater. Change shed. Put in next tabby row, followed by next design thread. Continue.

To narrow or widen design, pass design thread under fewer or more warp threads, dropping them out at sides, or taking them up. Loops are formed between rows, see M.

The RIGHT SIDE of design is the side with loops going from row to row showing. However, the smooth side underneath may be used as the right side if preferred. But be sure to piece on what you call the wrong side. To piece simply overlap ends, see L.

Do not have the design thread so heavy that it will make the weft form humps at design places. Test out a small portion, and change thread to suit.

There is no lovelier design for a guest towel than this dainty dogwood blossom, worked in a design thread of white floss or Perleen against a tabby background of a soft green shade, either cotton or linen, with touches of cepper in stem and petal tip

- TEXTURE:** Warp: 20/2 white cotton (Lily's) or Umbrian, medium green (Bernat's)
 Weft: Tabby, same weight as warp; green pastel linen 18/1 or ramie, (Fawcetts or Pearl Size 20, green or olive, (Lily's))
 Design Thread: Crochet Cotton or Pearl Size 5, or 6-strand, (Lily's) or Bernat's Perleen or Perle 5.

A. PLANNING DESIGN.

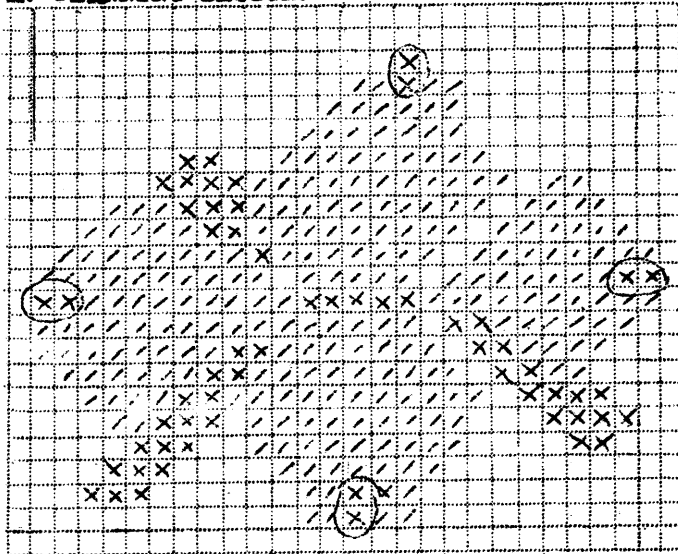

WEAVING PLAN: Size of finished towel, - 10" x 18".
 Hem: Weave 2 1/2" tabby, green for 1" hem. Then, for stripes, - 3 rows tabby, heavy white design thread. 2 rows fine green tabby. 1 row heavy white tab thread, tabby. 1/2" fine green tabby. (See sketch at right for these stripes.)
 Now lay in design.

B. GUEST TOWEL

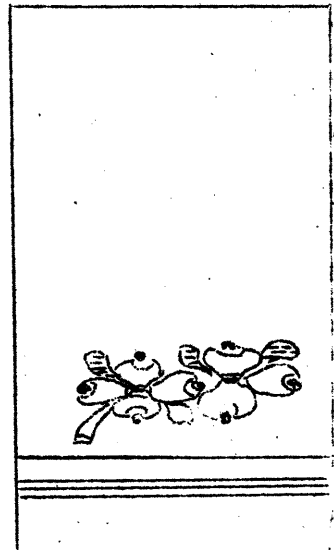

C ← 50 checks across design from C to D, - 100 warp thds. → D

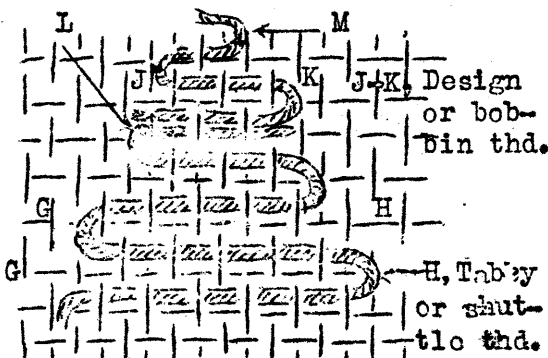
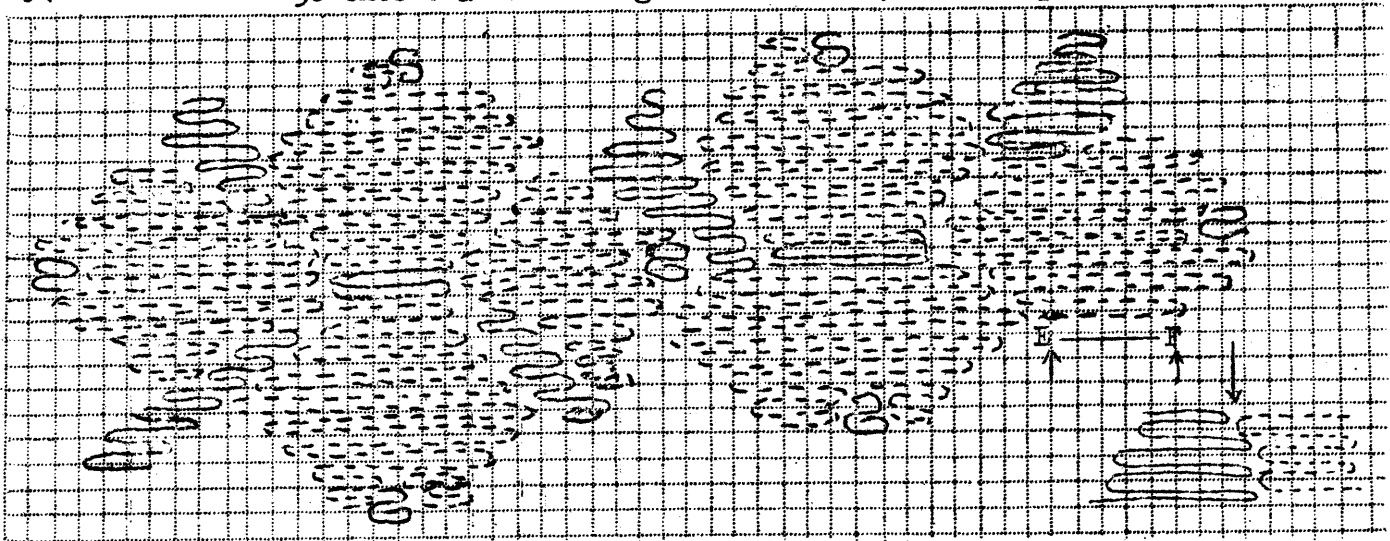

KEY TO DIAGRAM: Each check on graph paper represents 2 warp threads. Therefore from E to F in petal, there are 5 checks or 10 warp threads; or when shed is made 5 warps up and 5 down. So the number of warp thds. to weave under, (5) corresponds to the number of checks, (5). This plan is easy to follow. Choose different signs for different colors. As one portion of design meets another and colors change, reverse them around adjacent warp threads, see arrow in detail below E-F above.

The Russian Laid-in Technique produces a texture surface resembling the overlapping of small brick-like oblongs, these being formed by the short lengths of heavy laid-in threads wherever the laid-in design occurs. The surface is most attractive, and beautiful effects may be obtained, with sections of adjacent colors setting off one another. The design forms laid in are mostly on the square, although many types of design may be adapted to the technique.

For the Laid-in the usual threading is the Twill, altho Birdseye may also be used, a pattern which provides an interesting texture as a background in other parts of the handwoven piece than the laid-in sections. It is best to use a number of colors for the laid-in effects, and very heavy yarns are best, such as soft floss perle, or several strands of Perle 10, or the regular Perle Floss sold by thread companies.

SUGGESTED THREADINGS: 1. TWILL 2. SUMMER & WINTER 3. BIRDSEYE 4. HERRINGBONE

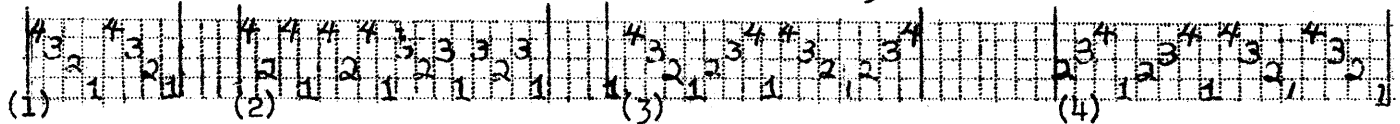

The effect of the brickwork obtained by treading the above patterns as directed is shown at the right. Two rows of Tabby follow each row of Laid-in. The under-side of the fabric appears mostly as a Tabby ground, with the Laid-in effect apparent on the upper surface. Use check-paper designs.

METHOD: After weaving a section of the plain Tabby ground with no Laid-in, for a sufficient base to your design, plan to transfer a simple design, sketched on check paper, to the fabric. Let each of the check paper squares represent four warp threads, one of which is raised, as shown at A. The design thread will pass under this shed, of every fourth thread on the upper surface and the intermittent three threads on the lower surface.

Usually two rows of the same treading combination, as given for the suggested threadings above, will weave up to enough thickness of weft to equal the height of a check-paper square. Possibly one heavy row is sufficient if your warp is set very close. If very far apart, you may need three or four rows.

To enable the weaver to execute this type of Laid-in on various pattern threadings, we have given four possibilities above. For numbers 1 and 2, i.e. Twill and Summer and Winter, the two rows of Laid-in are:

- Row 1: Harnesses 1, 3, 4 together.
- Row 2: " 2, 3, 4 "

For numbers 3 and 4, i.e. Birdseye and Herringbone, - (Note that the reverses of the Herringbone must be on Harness 1) - the two rows of Laid-in are:

- Row 1: Harnesses 1, 2, 4 together.
- Row 2: " 2, 3, 4 "

For one complete row of Laid-in, one treads Row 1, followed by two Tabby rows. For the second alternating brick-

(Creative Crafts, Guernsey, Pa.)

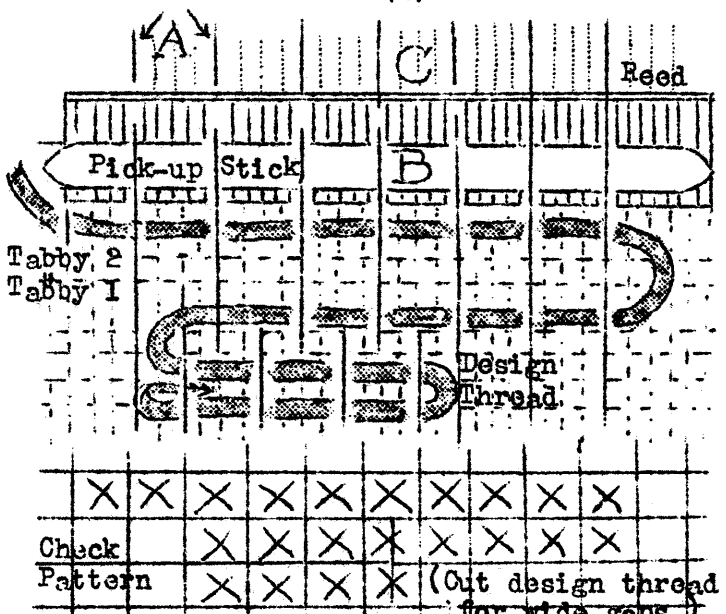

work row, one treads Row 2 followed by both Tabby rows. Either Row 1 or Row 2 is repeated as desired to make the brick layer as wide as desired. For instance, treadle Row 1, then two rows Tabby. Repeat one, two or more times. Then treadle Row 2, then two rows of Tabby. Repeat one, two or more times. Keep repeating all the foregoing until design has been laid in, then weave plain.

The detailed directions follow:

Treadle Row 1. With pick-up stick lift up the part of design designated by the checks, such as at B. Lay in heavy design thread. Push pick-up stick back against beater, as at C. Then:

- Weave: Tabby, 1st plain weave shed.
- Tabby, 2nd plain weave shed.

Push pick-up stick through same row and repeat above, if desiring to make brick-effect thicker. Take stick out.

Treadle Row 2. With pick-up stick, lift up next row of design. Lay in heavy design thread. Push pick-up stick back against beater. Weave 1st row of Tabby, then 2d row. Repeat as desired.

Repeat Rows 1 and 2 until design part ends

Mexican Lace Stitch is used for table linens, runners, lace drapes, etc. Since the warp shows as part of the openwork, it should be of round linen or firmly spun long-staple cotton. For a mercerized texture, use Perle 10 at 24 to 30 per in; for a heavy linen texture, use 13/8 linen at 16 to 18 per in; for finer linen texture, use 30/2 at 20 to 24 per in.

THREADING: Thread as a Twill, 4, 3, 2, 1. This brings the warp up in pairs, making it easy to twist pairs around each other, as at A. Use left hand to pull threads at right across those coming from left.

SINGLE LACE STITCH: Leave 1/2" to 1" at sides, and weave with tabby. For the left side, B, continue with last weft thread. For right side, add a new thread. For this openwork, twist adjacent warp threads around each other, holding them with a crochet hook; then draw weft through. Keep threads that were over during last row of weft at C, also over weft row of openwork, as at arrows, G; and keep those that were under at last row, under for this row also. In between, interlock them as shown. After the openwork row, fill up side margins again with tabby weave. Take regular weft thread for one side; add extra thread at other side. Make same number of weft rows above openwork as below it to make 1st row of solid weaving interlock properly through the warp threads.

DOUBLE LACE STITCH. This stitch is made by interlocking pairs of threads. It is most effective. A single row of the interlocked pairs makes a complete border, D, and one may close with tabby directly above it. However, the double threads may be separated into single warps, as in row E, and the SINGLE LACE STITCH be made as shown between two rows of the Double, E, F.

To weave the DOUBLE LACE, leave 1/2" to 1" for margins, G. Use last weft three numbered 1. to make tabby at left margin finishing as shown. Start 2d weft at right weave right margin, and use this weft for openwork row, D. Carry 2d thd. to margin at left and finish here. Start 3rd three just above openwork row at right, go across in single lace, finish at left. Start each new thd. in this way at right use for openwork row, finish at left.

For DOUBLE LACE, D, start by bringing 3 thds. down, as at H; continue under 2 and over 2. Make up each pair from thds. in same shed, i.e. thds. that were over in last row of tabby make a pair and stand over through openwork.

Above center, for SINGLE LACE, E, again put pairs that were over in row D, over weft in row E. For row F, which is double again, follow same rule, putting thds. that were over, over; those that were under, under. Close openwork into tabby above all lace, with same number of margin rows above F as were below D.

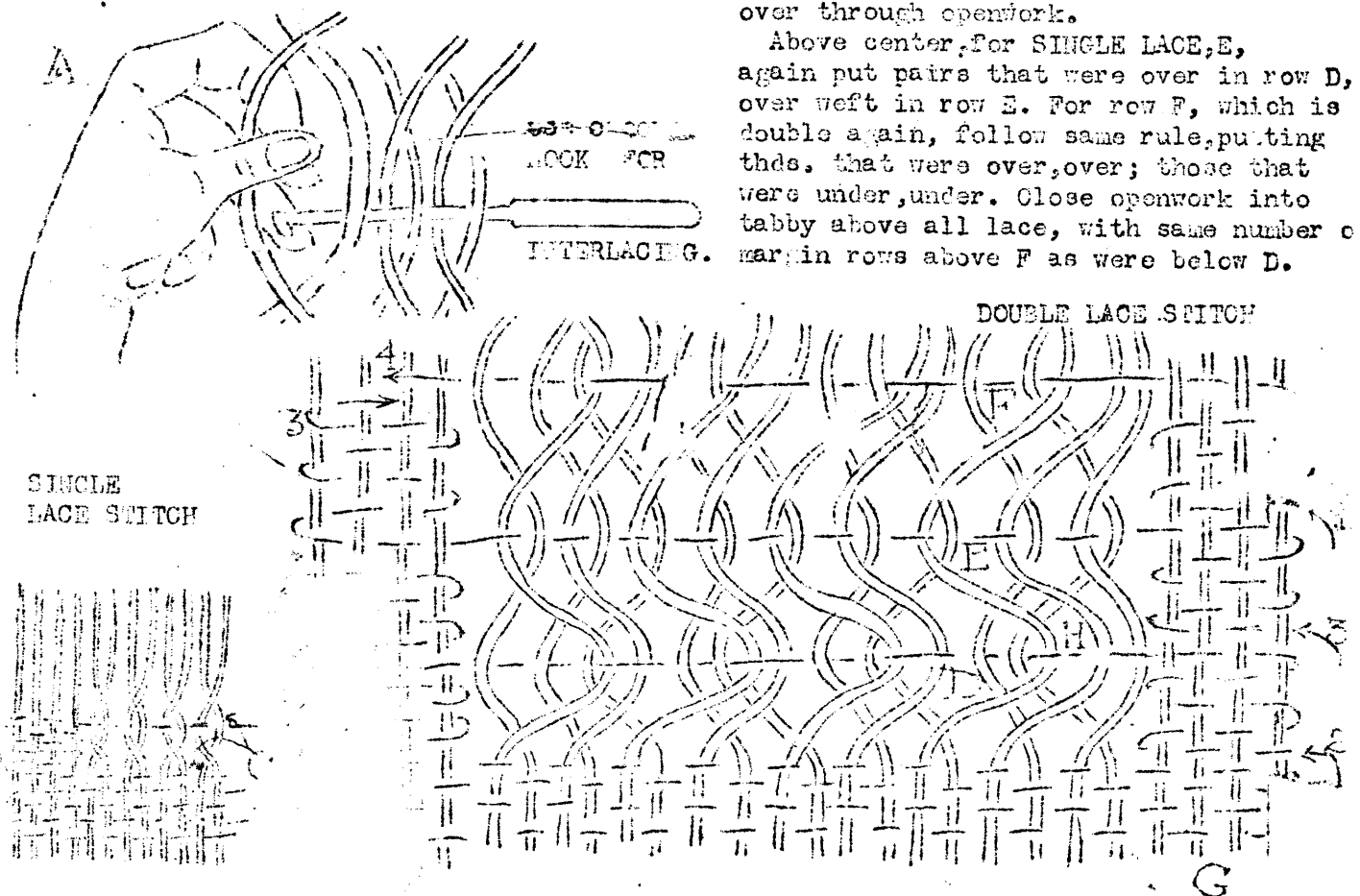

The Danish Medallion is one of the simplest types of lacework weaves to execute, yet one of the most effective. Just a single complete row of the weave is effective at the ends of a doily, and combined with other types of openwork, such as Mexican, it may be worked up into quite elaborate borders. One can picture it in rather coarse texture at the base of heavy linen or perle curtains.

WARP PLAN FOR FILMY LACE DOILIES

Warp: 30/2 linen or Egyptian Cotton 24/3
 Weft: Ibid for tabby; floss linen or Crochet Cotton for design threads.
 Thds. per in: 20 to 24
 Threading: 4,3,2,1, to be woven as tabby, 1,3, 2,4.

WARP PLAN FOR CLOSE TEXTURE

Warp: 10/2 perle Cotton.
 Weft: Ibid for tabby; Perle 5 for design threads.
 Thds. per inch: 30
 Threading, 4,3,2,1 woven as Tabby.

HEAVY LINEN TEXTURE: Use 18/2 at 16 per inch. Weft: Ibid; Design, Floss.

CHARACTER OF THE WEAVE:

The background of the weave is Tabby. The design thread which executes the Danish Medallion Stitch, takes stitches similar to button-holing over groups of the warp threads; and the rounded character of the stitch is enhanced by pulling out the warp threads at the points of the button-holing, as shown at A in sketch. One may take the stitches at regular intervals, or plan a design with medallions covering planned spaces that are unequal, as in sketch at lower right. The area covered by the stitch may thus represent a design,—a conventional flower, animal, etc.

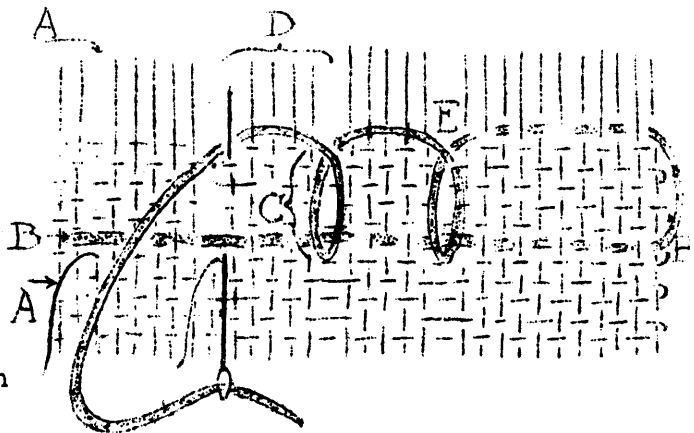

DIRECTIONS for MAKING MEDALLIONS:

To make nodes for the button-hole stitches, take out warp threads at regular or irregular intervals, as at A. In the 30/2 linen, with 20 threads per inch, a good spacing would be 5 threads to a stitch, skip 1, leave 5, etc. This would give a stitch about 1/4" long. In the closer texture with Perle 10 warp, leave 7 threads, take out 1, leave 7, etc. In the heavy linen, leave 4, take out 1, leave 4, etc.

For the design thread use a different color or a heavier thread to bring out the outline. For base of stitch, weave several rows of tabby, then add a row of the design thread through the last tabby shed, E. Now weave several rows with the regular tabby thread, making height of stitch, C, equal to its width, D. Next bring design thread around selvage edge, make next shed, lay it through up to first opening, and take first button-hole stitch, E, passing down over the basic row of the design thread, E, around it and up under its own thread. Continue, going through tabby, taking stitch around the basic row, etc. Mexican Openwork may also be used next to Medallions, as at F. Leaflet 760.

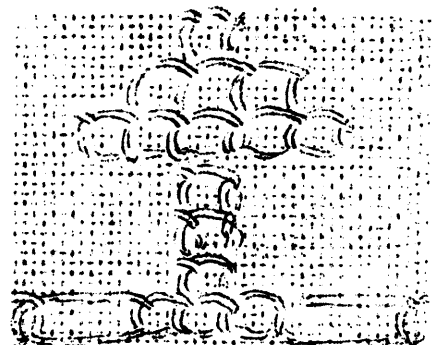
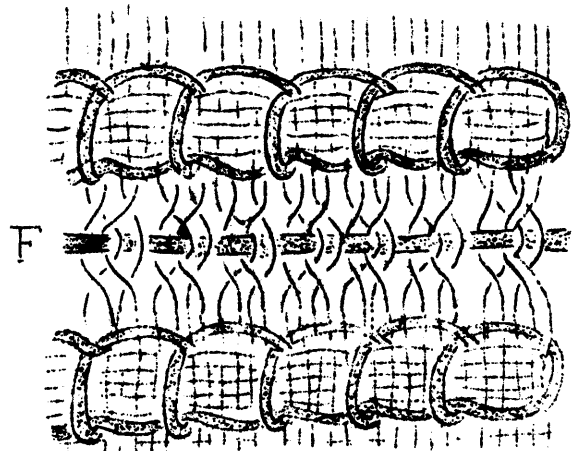

The Spanish Openwork Weave is suitable for decorative lace borders on doilies, or mats, towels, runners, etc. It is effective with its lacey motifs at the center or base of glass curtains, or at the ends of side drapes. Cross-stitch motifs may be reproduced in the Spanish Weave, and the stitch is more quickly done than embroidery.

Only round linen should be used for warp, or a 3/ply cotton, such as 16/3 Egyptian. A linen a bit heavier than the warp should be used for weft; or a cotton of firm body, as 10/3, Perle 5, etc. The stitch is made on a tabby foundation, and the weft shifts back and forth between small sections, taking 3 to 5 rows in place of the usual one.*

WARP PLANS: (Heavy Lace)

1. Warp: Linen 18/2 or 16/2; Cotton, 16/4.
Weft: Linen Floss; Cotton, Perle 3; 10/3.
Threads per inch: 16 to 18.

2. (Medium Weight Lace) Warp: Linen 30/2 or 40/2; Cotton 5/2 or 24/3.
Weft: Linen or Cotton Floss; Perle 5.
Thds. per inch: 20 to 24.

3. (Fine Weight Lace) Warp: Linen 50/2; Cotton 20/2 or Perle 20; or 24/2.
Weft: Linen 20/2; Cotton Perle 10; 20/3.
Thds. per inch: 30 to 36.

DIRECTIONS FOR WEAVING:

There are four methods, of which No. 1 is the simplest. Make 3 back-and-forth stitches in place of each weft row, see Fig. 1, A. Always weave to the left on Hs. 1&3; to right on Hs. 2&4. Start at A. Leave 6 to 10 warps for marginal section, acting as border. Put in 1st row, A-B. Pull weft to right, making a small hole. Change shed to 2&4. Weave to right back to selvage.

From now on, weave across former section such as AB, and add new section to next opening, CD, all on shed 1&3. Change sheds. Reverse on 2&4, weaving D to C. Pull weft to left, change to 1&3, weave C to E. Continue thus, forward under 8 warps, back under 4 warps, to left selvage. Here add a larger section as last section, and weave back and forth 3 times across it, as shown, H.

DIRECTIONS FOR WEAVING. Continued.

Next return all across warp to right, on Hs. 2&4. See middle line, x. At right start second row of lace as shown, right to left.

METHOD 2. Figure 2.

The first part is the same as Method 1, i.e., weave to the left over sections of 4 warps each, 3 tabby rows each, until last section a larger span for border. Instead of returning right as tabby one row, weave 3 more rows to start, I, and proceed right adding new section each time, reverse of former row. Third row is like 1st; 4th like 2nd.

METHOD 3. Figure 3.

Row 1, like row 1 in Method 1. Return to right side with one row tabby. Fill in with 3 more tabby rows at edge, but add 2 warps more for border section, i.e. up to center of 1st group of four, as at arrow, J. From now on add 4 more warps for each new group i.e. to center of each group of last row. Return to right as plain tabby row, K.

METHOD 4. Figure 4.

Row 1, like Row 1 in Method 1. Split the groups on the return row, i.e. going from left to right, taking 2 more warps at beginning of border section, arrow, L. Before reversing, weave 3 rows at selvage border, M.

DESIGNS: The design may be openwork, see (a) or the background lace, (see b), Figure 5.

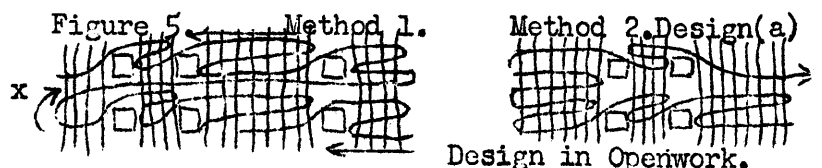
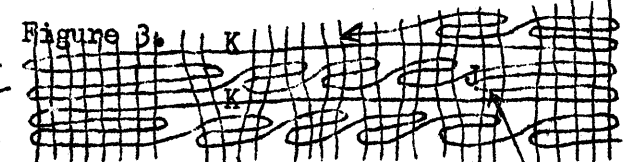
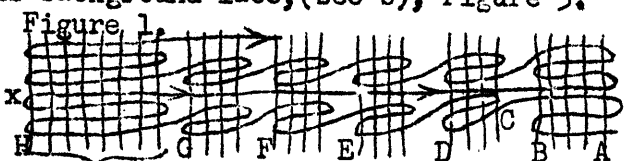
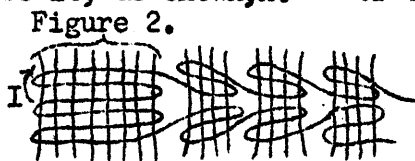
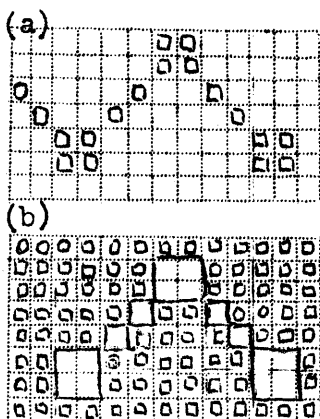

*Note: Book of Spanish Lace Designs by Howells, \$1.25. Also see leaflets 764 and 764-a for useful designs. The circles or crosses represent openings.

These choice cross-stitch designs are from the booklet on Spanish Openwork, by G.W.Howells. They may be used to add interest to gillies, towels, table scarves, drapes and purses. They are suitable for Finger-Weaving, (L.750); Italian Laid-in Weaving(L.756); Straight Laid-in(L.758); Danish Medallion, (L.762) Spanish Openwork, (L.763); European Buratto(L.765) Mexican Method of Laying-in on a Pattern(L. 771); and Russian Laid-in(L. 755).

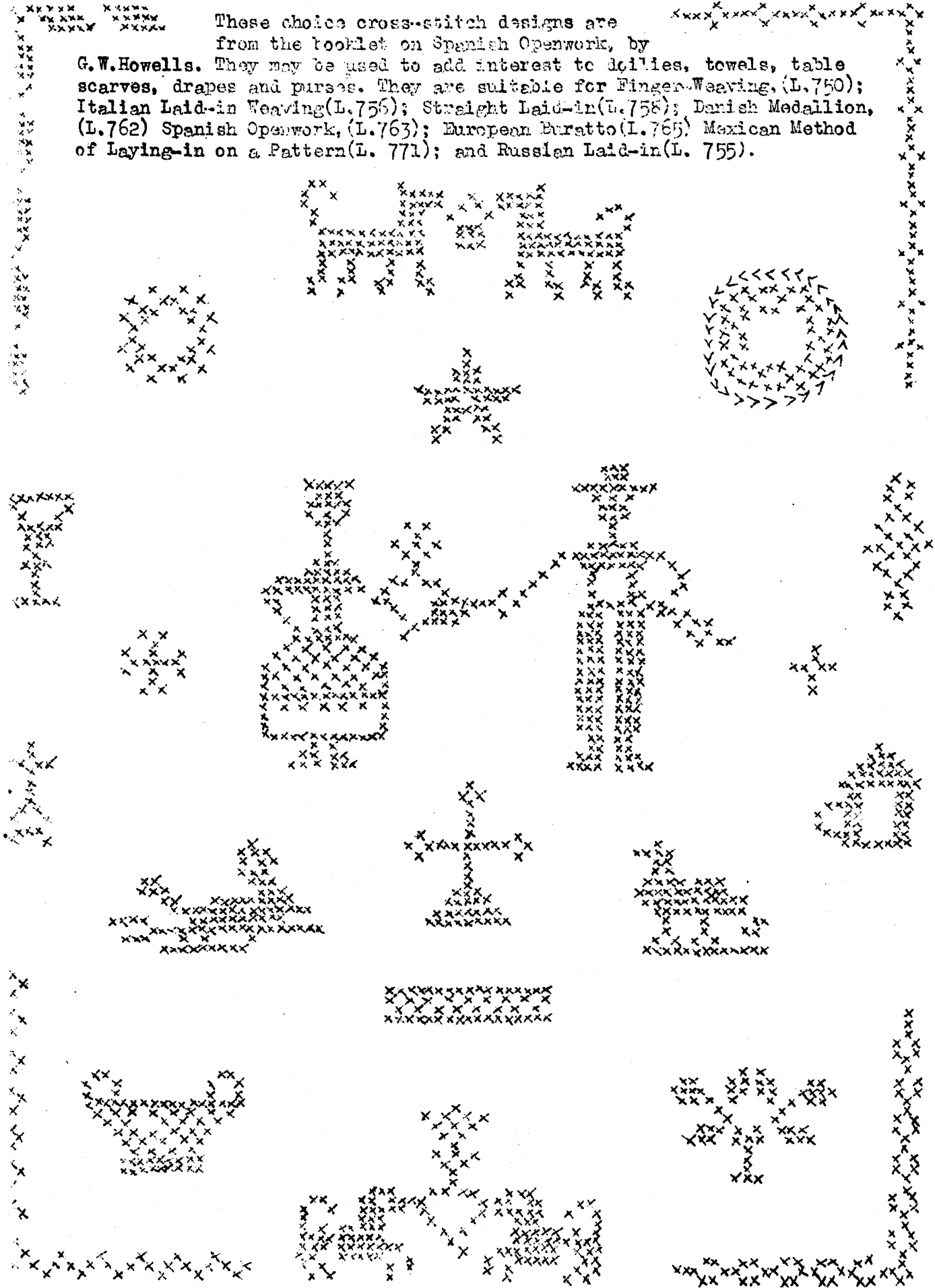

What could be a more pleasant surprise to friend or family than a holiday runner or towel with end designs of winter motifs. Call it a Christmas Tree runner, or if it is desired for all-year-round, name it a "pine" or "hemlock" design. Various design methods make it possible to weave cross-stitch motifs into the fabric on the loom. One may use either a 2-harness or 4-harness threading, but the background weave is always the plain weave or "tabby". Those whose looms at present are threaded to 4-harness patterns can use them as they are, weaving only the plain weave sheds.

Such designs as those given below may be worked with the following techniques :

Spanish Openwork:	Creative Crafts Leaflet No. 753
Danish Medallion:	" " " No. 752
Italian Laid-In:	" " " No. 756
Dukagang, or Scandinavian Laid-In:	" " " No. 750
Straight Laid-In:	Creative Crafts " No. 758
A New Texture Effect:	" " " No. 767

THE METHOD USED IN PINE TREE: For the design at lower right, we chose method in L.767. This leaflet was published in the August-September issue

We used two wefts, a fine weft same size as warp, and a design weft about twice as heavy as the warp. We carried both through our warp on stick shuttles. For the design sections, carry shuttle through tabby shed for a space at side before beginning stitch, see A. Then bring shuttle up out of warp, as at B, back-stitch across several warps, (in this case, 3) enter shed again, see arrows, and come out further along, as at C, (in this case the shuttle passed forward under 8 warps, 3 of which had been passed over at B). The weft now takes another similar back-stitch, enters shed again, and goes forward, as at D. The weft continues thus all across design as far as desired.

THREADS TO USE:

For warp of 8/4 carpet warp, use texture thread of tufting cotton, green.
 For Size 20/2 warp, or 24/3 warp set at 30 or 32 per in. use Perle 5 texture thd.
 For Size 16/3 or Perle 10 warp set at 20 to 24 per in. use Perle 3 texture thd.

PLAN OF RUNNER BORDER:

Leave fringe if warp is Perle. Then 3/8" tabby, same thd. as warp; then E, one row texture stitch; 3/4" tabby, fine thread; F, one row texture; 1/2" tabby, fine thd; G, 1 row texture, heavy thd, 1 row tabby, same thd, 1 row texture same thd; 3 rows tabby, fine thd. From this point on alternate 3 rows of heavy colored texture thd. like G, with 3 rows plain tabby fine thd., until design is finished. Make narrow borders at top, - H like F, J like E.

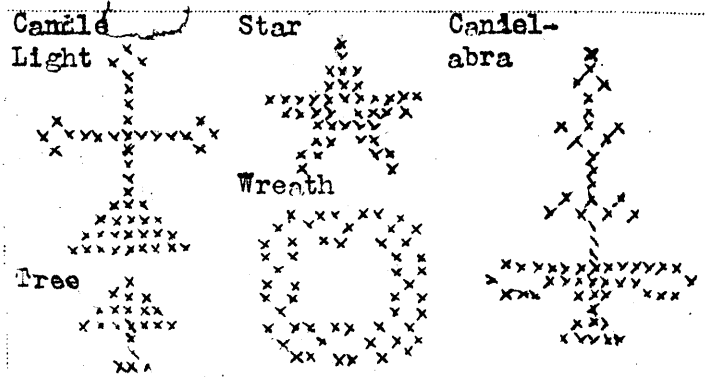

Towels may have narrow borders at other end.

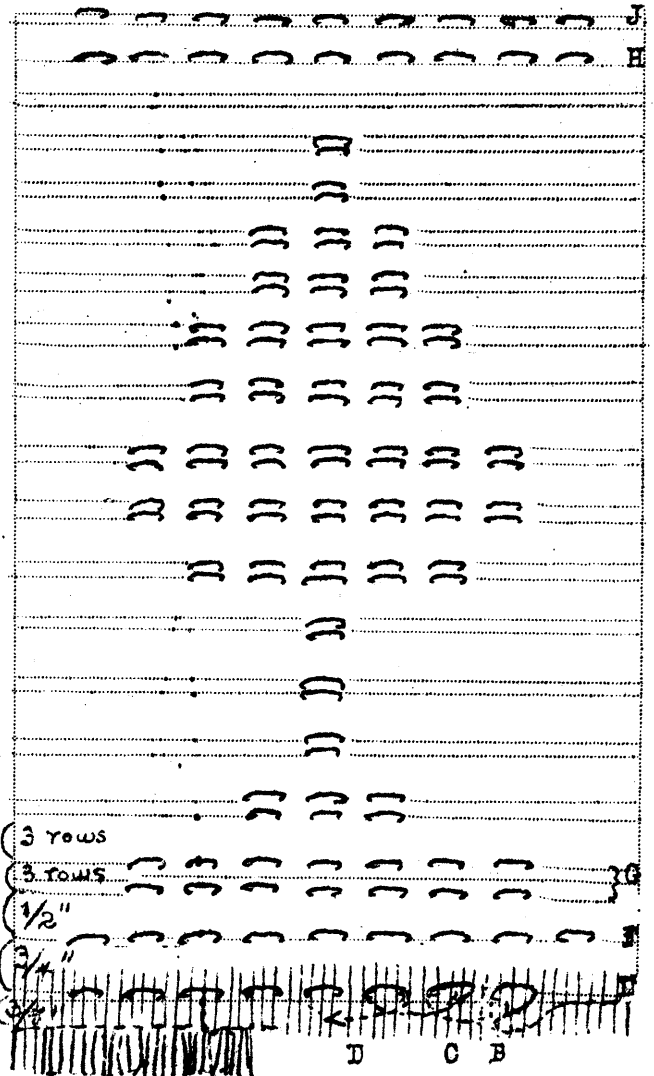

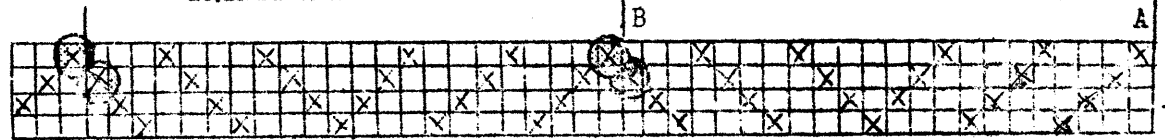

Width: 13 1/2"

Tnds. per inch: 16

Total No. thds. 221

Warp & weft, 18/2 linen

K: Finished

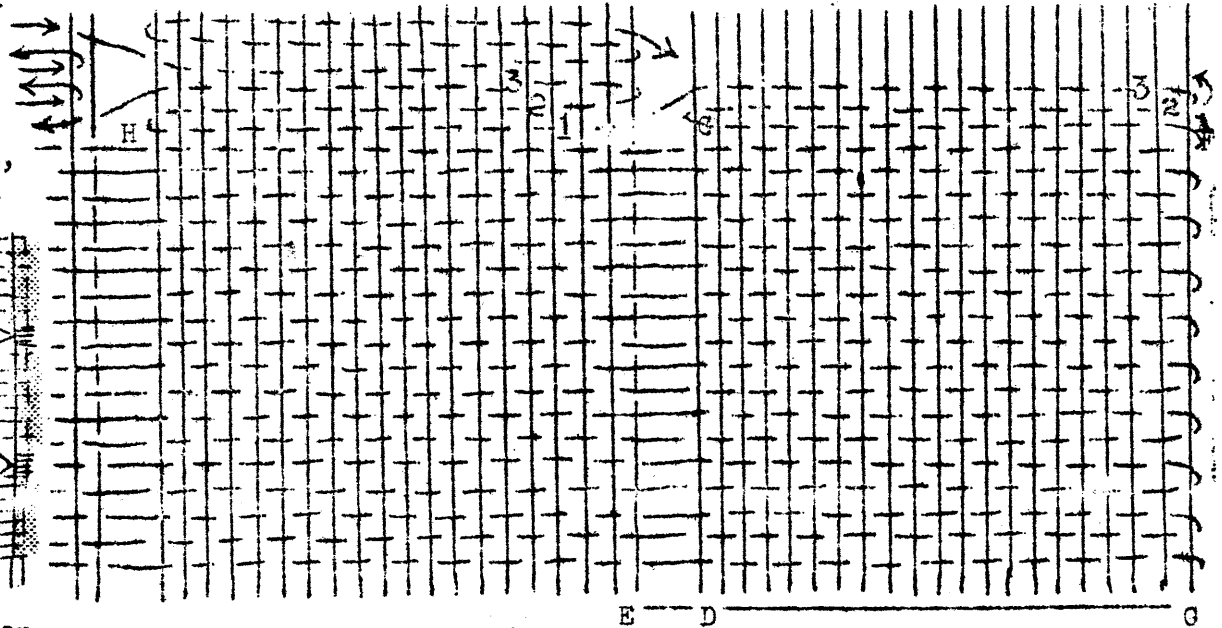
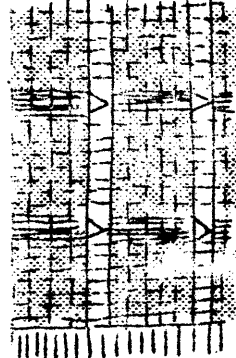

Threading Plan:

repeat A-B, 22 thds. 10

times. Add one thd. on Har. 4.

Total, 221 threads.

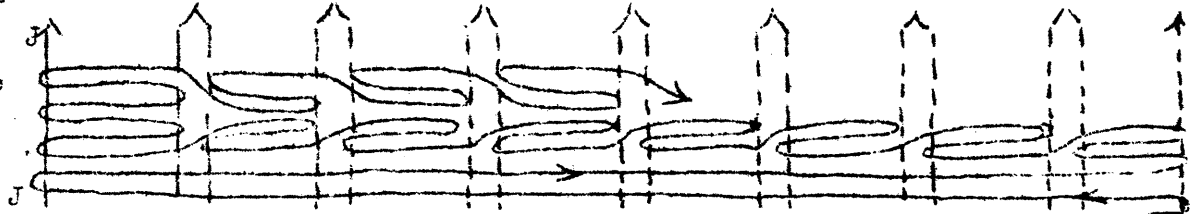

SPANISH LACE DOILY. To make a lace doily with squares of weaving separated by lacey openings in the simplest kind of Spanish Lace-stitch, thread in either tabby or herringbone as shown. Take threads marked by circles out of reed and heddles, rolling them up on a stick at back of loom parallel to roller. Your warp is now composed of groups of threads, CD, separated by open spaces, DE.

WEAVING PLAN. Leave 2 inches unwoven for fringe. Weave as tabby, 1&3, 2&4 for distance CF equal to group CD to make square of solid weaving. Now for section of openwork, weave from F to G, row 1, only across first group of warps; then make next shed and weave back to F, row 2; make next shed and weave to left, row 3, across this first group but also continue across second group to H. At this point repeat the process, going back once to the right across one group only, then to left across this group and next, and repeat. Continue all across warp as shown in lower sketch up to left selvage, J. Here reverse with six rows, - up to selvage, back to right, up to selvage again, back to right, up to selvage again, and back to right and over across next group. In weaving toward the right simply repeat the same method used in going to the left, - i.e. across one group to right, back to left across same group, back to right across this same group and across the next group. When you have finished two complete lace-work rows, and arrive at right selvage, simply continue the regular weaving with a complete row to the left, etc. making another square of solid weaving equal to distance CF.

FINISHED DOILY. VARIATIONS. The finished appearance of doily will be as at K, with rows of Spanish Openwork forming squares with the warp spaces, as shown in sketch above. Any number of Openwork borders may be put in. Always beat them down firmly, to make the heavier texture of cloth at this point form a nice contrast with the lace openings across the warp spaces. For wider spaces, omit 4 threads for warp spaces. Replace vacant threads to weave herringbone variations.

FOUR-HARNESS PATTERNS

Short Overshot for Upholstery,
Towel Borders, and Runners
Larger Patterns for Rugs and
Coverlets.

MODERNISTIC BORDER FOR A LUNCHEON SET

This little block border is excellent for towels or luncheon sets. It may be woven in many different ways. Woven solid, it becomes a firm, minutely figured upholstery pattern; woven with only several rows of pattern work, it makes a dainty border.

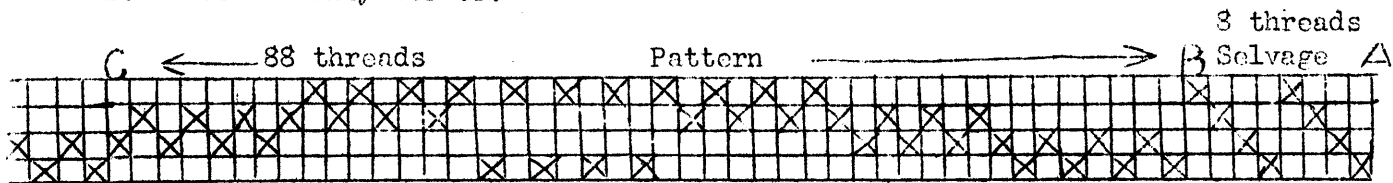

Edge of Border

	<u>Pattern</u>	<u>Tabby</u>
(a)	3 - 4	(b) 1 - 3
(c)	2 - 3	(d) 2 - 4
	1 - 2	1 - 3
	1 - 4	2 - 4

Weave several rows white tabby in between Edge of Border and Center of Border.

Center of Border

	<u>Pattern</u>		<u>Tabby</u>
	3 - 4	Brown	1 - 3
	3 - 4	"	2 - 4
	3 - 4	"	1 - 3
	3 - 4	Burnt Orange	2 - 4
	3 - 4	"	1 - 3
	3 - 4	"	2 - 4
	3 - 4	Light Orange	1 - 3
	3 - 4	"	2 - 4
	3 - 4	"	1 - 3
	2 - 3	Yellow	2 - 4
	1 - 2	"	1 - 3
	2 - 3	"	2 - 4
	3 - 4	Light Orange	1 - 3
	3 - 4	"	2 - 4
	3 - 4	"	1 - 3
	3 - 4	Burnt Orange	2 - 4
	3 - 4	"	1 - 3
	3 - 4	"	2 - 4
	3 - 4	Brown	1 - 3
	3 - 4	"	2 - 4
	3 - 4	"	1 - 3

Weave several rows white tabby

Edge of Border

	1 - 4	Brown	2 - 4
	1 - 2	"	1 - 3
	2 - 3	"	2 - 4
	3 - 4	"	1 - 3

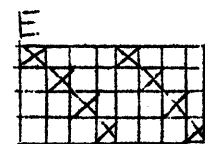

Threading for a Luncheon Set

Width of Material	13"
Size Sley	16
Threads per inch	32
Total No. Threads	422

Threading

Selvage A to B	4 times (8 thds)	32
B to C	4 times (33 ")	352
C to D	1 time (6 ")	6
D to E	4 times (8 ")	32
	Total	422

Weaving Draft

In this, as in all pattern drafts, remember that a tabby thread follows each pattern thread. The treadles are numbered from left to right, 1, 2, 3, and 4. The tabby combinations are 1 and 3, 2 and 4. With foot on treadles 1 and 3, always run the tabby thread from right to left; with the foot on treadles 2 and 4, always run it from left to right. Never change this rule, and you will gradually remember which tabby thread comes next without written assistance. In the accompanying draft, read alternately from the two column, i.e. a, b, c, d, etc.

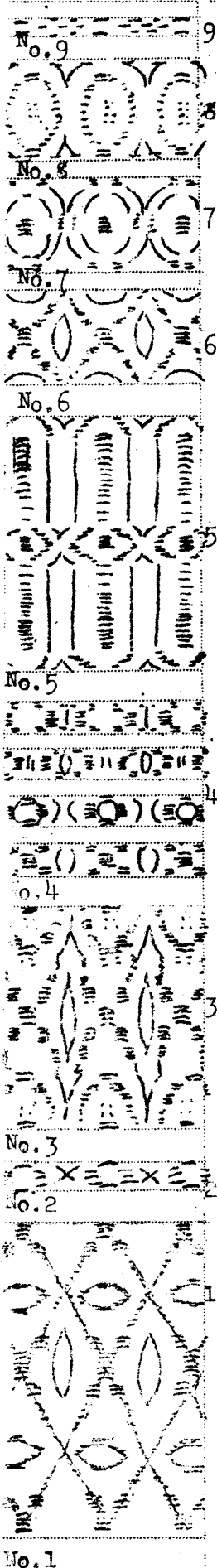

"Honeysuckle" admits of more variation than almost any small motif pattern. In columns at left and at right of this page there are the two parts of sampler described in Leaflet 308. The border at base of the sampler is shown at lower left, labeled No. 1. Only a few of hundreds of possible variations are given here.

The Honeysuckle Pattern consists of two motifs, an oval with a small cross between its repeats. In planning the pattern, one starts with the oval, and should finish with the same. The pattern is given below, as well as a new conference texture pattern by Miss Allen, that may be woven according to the same directions as the Honeysuckle with good effect.

Miss Helen L. Allen says of Honeysuckle in our National Conference lectures: The Honeysuckle Pattern is really an example of a Herringbone type in which some of the harness combinations are repeated. It too, as well as simple Diamond patterns may be woven as Twill. When reversing at the center of this pattern, use an extra tabby thread to make the combination come out even, maintaining a similar texture effect; or weave an extra row of the pattern combination that forms the center.

Mrs. Mary Atwater, in the Shuttlecraft Book of American Handweaving, says of Honeysuckle, -

"Honeysuckle comes, who knows whence? It is a charming little pattern and resembles the flowery figure of the Pine Bloom, from which it was doubtless derived. Who began using it as a pattern by itself, separated from the characteristic "table" of the old pattern, - and who named it - no one seems to know, though the thing is so recent. There appear to be no ancient pieces of this pattern, but it has become quite common of late. Unlike "Monk's Belt" it is decidedly in the American manner and goes well with Colonial detail."

Weaving a sampler with this versatile pattern can be a delightful project. Choose tones of rose and blue; or combine green, golds and dark browns with touches of orange and flame. The sampler is effective hung on the wall. Weave 12" to 14" wide.

HONEYSUCKLE DRAFT. See also L. 809.

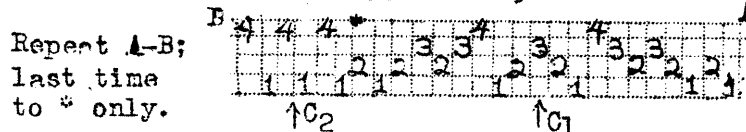

NEW TEXTURE PATTERN

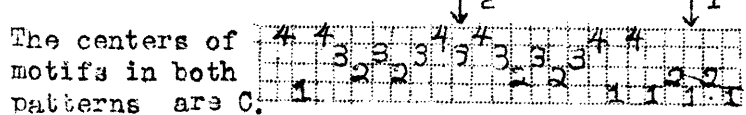

Repeat pattern throughout from right to left. After last repeat add 1.2.1.2

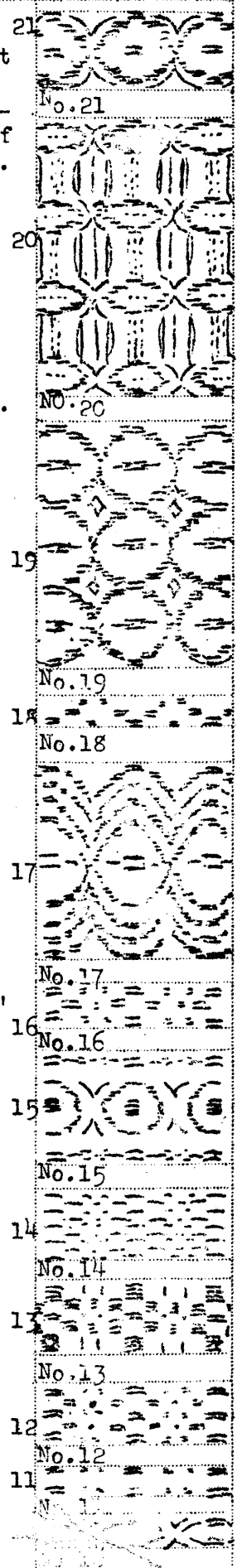

Border No. 1. Two Shades Rose

4-1, 4x Border is
 1-2 3x 2" wide.
 2-3 3x
 3-4, 2x } Dark
 4-1 once } Shade
 1-2 once
 2-3 once
 1-2 once
 4-1 once
 3-4 2x Light
 2-3 3x } Shade
 1-2 3x
 4-1 4x Center of
 Border. Reverse

Warp: 24/3 or 20/2 at 30
 Tabby Weft: Same (or 32)
 Pattern Weft: Perle 5 or
 Tulip 3-strand.
 Leave 3/4" Tabby between
 borders.

No. 14. Dark Blue & Pale (1/2")

4-1 once, dark
 2-3 once, light. Repeat
 to 1/2". End with 4-1.

No. 15. Old Blue, Navy.

4-1; 2-3; 4-1; each once
 Weave 6 rows Tabby (Old B)
 4-1 2x
 1-2 2x Old Blue.
 2-3 2x
 3-4 2x
 4-1 4x. Navy. Center. Rev.

No. 6. Dark Rust (1" wide)

2-3 2x
 1-2 once
 4-1 once
 3-4 once
 2-3 3x
 1-2 3x
 4-1 6x. Center. Reverse.

No. 16. 2 Shades Rose. (1/4")

4-1 2x Pale Rose
 2-3 2x Deep Rose
 4-1 2x Pale Rose

No. 2. Use 3 Shades (3/8" wide)

4-1 once, Dark
 1-2 once Middle
 2-3 once Light
 1-2 once Middle
 4-1 once Dark

No. 7. Middle Rust or Rose (1" wide)

1-2 2x
 2-3 once
 3-4 once
 4-1 once
 1-2 3x
 2-3 3x
 3-4 once
 4-1 6x. Center. Reverse

No. 17. "Waves of the Sea".

4 Shades Blue, 1 Rose
 4-1 2x (3" wide)
 1-2 2x
 2-3 2x
 3-4 2x

No. 3. Use 2 Shades (2 1/4")

4-1 once
 3-4 3x
 2-3 3x } Dark
 1-2 3x
 4-1 2x
 3-4 6x } Light
 2-3 4x
 1-2 3x
 4-1 4x. Center. Reverse.

No. 8. Pale Rose (1" wide)

2-3 2x
 3-4 once
 4-1 once
 1-2 3x
 2-3 3x
 3-4 6x. Center. Reverse

Repeat these rows
 with 4 shades blue in
 order: Darkest; Dark; Mid-
 dle; Pale. At center put
 Rose: 4-1; 2-3; 4-1.
 Reverse: (3-4 2x; 2-3, etc.)
 same colors (in reverse
 order)

No. 4. Four blending Colors.

1-2 2x (Each part 1/2 in)
 4-1 6x Deep Rose
 1-2 2x
 4-1 2x Insert 6 rows
 Tabby here.
 1-2 6x Middle Old Blue
 4-1 2x
 6 rows Tabby
 2-3 2x
 1-2 6x Middle Old Rose
 2-3 2x
 6 rows Tabby
 1-2 2x
 2-3 6x Deep Blue
 1-2 2x

No. 9. Dark Red (3/8" wide)

4-1 2x
 2-3 2x
 4-1 2x

No. 18. 2 Shades Rose. (1/4")

4-1 2x Middle Rose
 1-2 2x " "
 2-3 2x Deep Rose

No. 10. Old Rose (1/2" wide)

4-1 once
 1-2 once
 2-3 once
 3-4 once. Center. Rev.)

No. 19. Upholstery Repeat (3"

4-1 2x (Middle Blue)
 1-2 2x
 2-3 2x 4-1 once
 3-4 2x 3-4 2x
 4-1 once 2-3 2x
 1-2 once 1-2 2x
 Repeat all to 3".

No. 5. Four Shades of Same Color. (2")

1-2; 2-3; 3-4; 4-1; Each once, Navy.
 4-1 6x; Bright Blue, Skipper.
 4-1 6x Middle Blue
 4-1 6x Palest Blue
 1-2; 2-3; 3-4; 4-1; Each once, Skipper.
 4-1 2x Navy, darkest Color.
 Center, Reverse from here:
 (4-1; 3-4; 2-3; 1-2; Skipper, etc.)

No. 11. Palest Rose (1/2")

4-1 2x
 Insert 4 rows Tabby
 4-1 2x

No. 20. Purse Texture. Lt. Bl.

4-1; 1-2; 2-3; 3-4; 2-3;
 1-2; 4-1; *each once.
 3-4 8 times. Repeat all
 for 2". Add to *

No. 12. 2 Colors (Maroon &

4-1 2x, Mar (Pale Blue)
 2-3 2x, Blue
 4-1 2x, Maroon. Center,
 Reverse from here.

No. 21. 2 Shades Blue or

4-1, 2x Rose.
 1-2 2x Light Blue
 2-3 2x
 3-4 2x
 4-1 2x Dark Blue. Center.
 Reverse from here.

No. 13. 2 Shades Blue

4-1 4x Pale Blue
 2-3 4x Middle Blue
 4-1 2x Palest Blue. Center.

In all the warp plans that we give in the Shuttle Service, we try to plan as many projects as possible on the same warp. The warp for narrow household items, is of a width that is practical for a table runner, A, a scrap basket, B, telephone screen, C, or a narrow pillow, D.

BUTTERNUT PATTERN ; Pattern, 36 threads-----Selvage
4 thds.

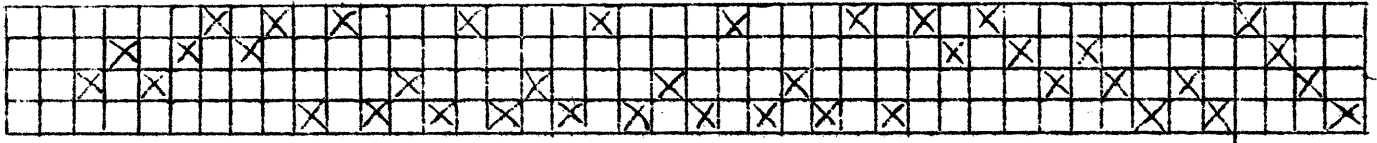

SWEET BRIER BEAUTY ; Pattern 38 threads-----Selvage
4 thds. A

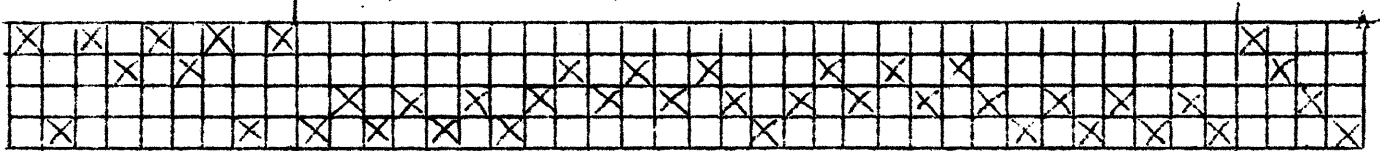

D C B A

BUTTERNUT PATTERN This attractive runner and cushion pattern, given at top, above, has an interesting oval formation in the shape of a butternut, sketched below. It is a most satisfying pattern when woven.

SWEET BRIER BEAUTY This pattern weaves into a four-cornered rose. It is a simple, effective pattern in rather square formation, contrasting to the Butternut Pattern of oval formation.

Width of Runner: 12 1/2"
Threads per inch: 32
Total no. of thds: 400

Width of Runner: 12 1/2 "
Threads per inch: 32
Total no. of thds. 403

THREADING:

Selvage, 5 X-----	no. of thds.	20
Pattern, 36 thds. (10X)---		360
Selvage, 5 X-----		20
	Total	400

THREADING:

Selvage, 4X-----	no. of thds.---	16
Pattern, 38 thds. (9X)-B-to-D ---		342
Last or 10th time, B to C only,		29
Selvage, 4X-----		16
	Total	403

WEAVING DRAFT :

1-2 4X	4-1 2X
2-3 4X	2-1 2X
3-4 4X	4-1 2X
4-1 2X	2-1 2X
2-1 2X	4-1 2X
4-1 2X	2-1 2X
2-1 2X	4-3 4X
	2-3 4X

WEAVING DRAFT :

1-2 8X	1-4 2X
2-3 6X	3-4 4X
1-2 2X	1-4 2X
2-3 6X	Repeat from beginning.
1-2 8X	

Repeat from beginning.

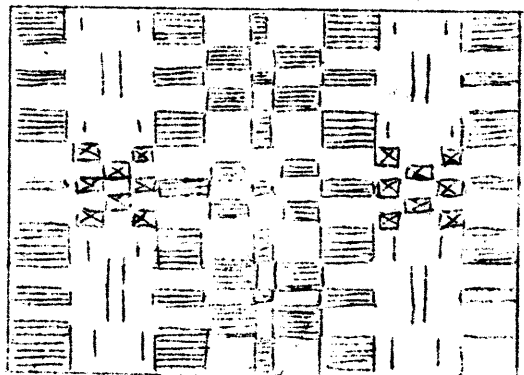
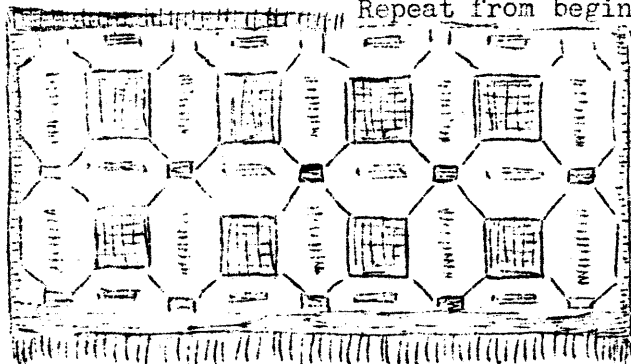

HONEY SUCKLE PATTERN

L.803

for

Upholstery, Chair-back Sets, Table Runners and Pillows.

This lovely upholstery sample is woven ~~at~~ a honeysuckle draft given in a recent issue. We are giving it here planned for material 11" wide, a good width for chair-back sets. Weave the large back piece 11" X 16", and the two arm pieces 11" X 8 ". You may leave a fringe between all pieces, or enough plain material woven for a little hem. To weave upholstery, double or triple the number of repeats of the pattern proper, i.e. from A to B.

PATTERN:- Honeysuckle
 WARP: 20/2ply or 14/2ply
 Size sley:- 16, with 2 thds.
 per dent.
 Total number Thds: 345

ARTICLE: Chair Back Sets
 WFT:- Perle 10 or Crochet Cotton.
 Width in Sley: 11 inches
 Length of Warp:
 Warp Cost per yard

Left	Pattern 26 threads																										Right Selvage
	X			X	X													X	X			X					
	X	X			X	X	X							X	X	X			X	X			X	X			
	X			X			X	X	X	X	X	X	X	X					X				X				X
X				X			X	X	X									X								X	

THREADING DRAFT

Right Selvage-----3 thds.
 Pattern, A-B, 13 repeats--338 "
 Left Selvage-----3 "
 Total 345 "

WEAVING DRAFT.

<u>Pattern</u>	<u>Tabby</u>
a- 3-4	b- 1-3
c- 3-4	d- 2-4
e- 3-4	f- 1-3
g- 3-4	h- 2-4

Repeat with Brown
 Repeat with Orange
 Repeat with Yellow

1-2	1-3
1-2	2-4
1-2	1-3
1-2	2-4

Repeat with Brown
 Repeat with Orange
 Repeat with Yellow

NOTE: In this as in all pattern drafts, remember that a tabby thread follows each pattern thread. The treadles of your loom are read from left to right: 1,2,3,4. The tabby combinations are 1-3, 2-4. With foot on treadles 1 and 3, always run your thread from right to left; with foot on treadles 2 and 4, always run it from left to right. Never change this rule, even when your threads are pieced, and you will gradually weave your tabby threads without referring to the pattern. In accompanying draft, follow the letters, a,b,c,d, etc., for first section of color in sample. Next section repeats 1-2, read in same way. Any three colors may be used.

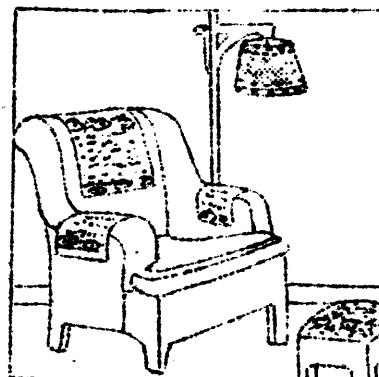
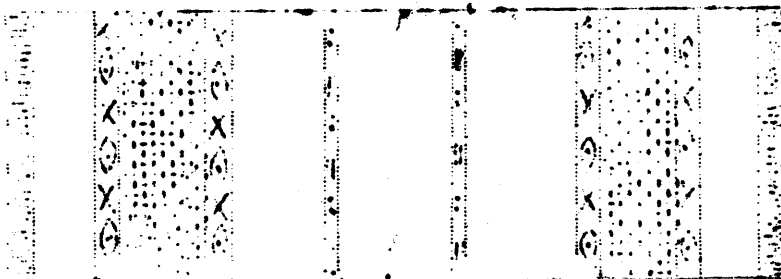

MAKING A HANDWOVEN LAMP-SHADE

Handwoven lampshades add a touch of elegance to home decoration. Weave them to match your upholstery and draperies; better still, plan an ensemble with the pattern woven solid for upholstery, in stripes for the curtains, and with narrow bands for the lampshade trim. Linen woven across a cotton warp makes an effective material, or all linen with its slight irregularities is good. The nubbed cottons so popular today may be introduced with effectiveness in the weft.

MATERIAL TO WEAVE: To find how much material it is necessary to weave, run a piece of smooth wrapping paper around your lampshade. Pin it halfway around, and cut out the shape of this half arc, as at A, leaving a 1-inch margin on all sides. Lay this shape on your loom warp, as at B, with the straight edge parallel to the warp. Weave enough material to cut out two of these pieces. This will bring the bias of the material at about the center of the woven strip, as at C. For the trim at top and bottom, weave one band 1 inch wide, with 1 inch tabby at either side, and weave another band 1/2 inch wide with 1/2 inch tabby at either side. Weave these bands in solid pattern. Two bands may be pieced together to make them long enough to go around the circumference of the shade.

COVERING THE LAMPSHADE: Buy a plain parchment lampshade and merely cover the outside. This saves lining, and the color of the parchment is excellent. Cut out your two pieces of woven cloth according to the paper pattern. Pin them together around the shade, as shown at D. Then stitch along the pinned joinings. Trim off seams and press down flat, then turn shade to right side, and slip over parchment shade. Pin cloth to upper and lower rims, stretching taut, as at E. Then sew down with over-and-over stitches. Now turn edges over this stitching, and stitch down again, as at F. Trim close to this stitching, as at arrow, G. You are now ready to sew on woven border. Turn edges of borders under, as at H, and baste flat. Also press down flat. Then blind-stitch the bands around the rims, as shown at J.

PATTERN: LINCOLN'S RAIL FENCE:

D	C	B	A
* *	* * * * *	* * *	* *
* *	* * * * *	* * *	* *
* *	* * * * *	* * *	* *
* *	* * * * *	* * *	* *

Width of Mat: 20" (for shade 12" in diameter)

Thds. per inch: 32 (or 30)

Total no. thds: 639 (or 600)

THREADING:

Selvage, A to B, -----	7
Pattern, B to C, (24) 26 X ---	624
Selvage, C to D, -----	8
Total	639

WEAVING: 4-3, 4X; 3-2, 4X; 2-1, 4X;
1-4, 4X; 2-1, 4X; 3-2, 4X; Repeat.

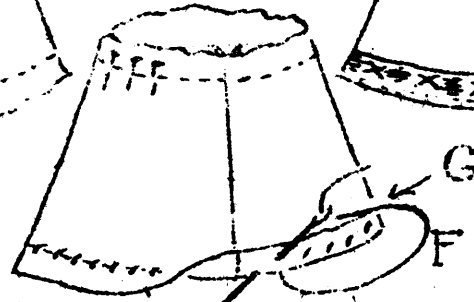
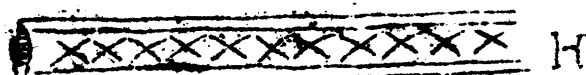
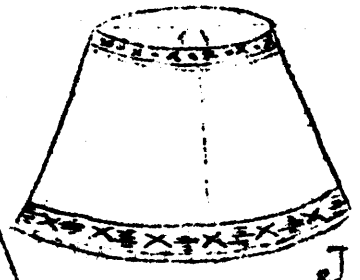
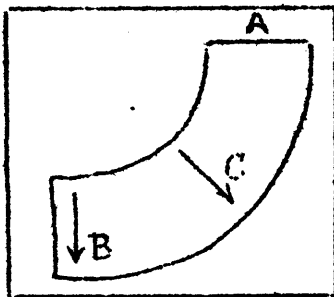

Pattern: Lincoln's Rail Fence

One motif.

An adjustable pillow is excellent on the backs of chairs in the living room, or in the car for long-distance trips. Move it where it will give you the most comfort, back of the neck or in the small of the back, and it will stay in this position. The finished pillow measures about 10" X 12", and the strap is 24" long. The weaving may be either two-harness with stripes or four-harness with pattern-work, preferably a small repeated pattern.

Kind of warp: Use 20/2ply, 30 or 32 threads per inch.

Width in reed: 25"

Total no. threads: 750(for 30-dent) 800(for 32 per inch.)

Weaving: For weft use umbrian warp with colored stripes in the same for plain weaving, or perle no.10 for pattern borders in pattern work. Weave the pillow with 1 1/2 inch bands at either side, as shown at A, or solid with pattern work or tabby stripes. Weave band as follows, and as shown at B: 1 1/2" pattern, 1 1/2" plain. Fold double for making strap.

Striped Pattern for Two-Harness Loom:

Any four colors may be chosen comparable to these blending colors of brown, orange, yellow and white.

- | | |
|--------------|----------------------|
| 1" brown | 1/4" yellow |
| 1/8" white | 3 rows white |
| 1/4" orange | |
| 2 rows white | 2 rows brown |
| 1/2" yellow | 2 rows yellow |
| 2 rows white | 2 rows orange |
| 1/4" orange | 2 rows white |
| 2 rows white | Repeat between |
| 3/8" brown | bars 3 times. |
| 1/2" white | |
| 3/4" orange | 3/8" brown |
| 3 rows brown | (3/4" yellow) Center |

Reverse pattern from Center.

Making Pillow: Finished material for pillow should measure 24"X10". This is folded double making the finished pillow 12" X 10".

Sew woven band over double as at C, stitch along edge as at D, sew a small bag of shot or lead weighing ounces to one end, as at E. Turn over to right side. When sewing pillow over double, insert unloaded end of strap, as at F. Sew around two sides of pillow only, as shown. Then turn pillow, pull out strap, and sew up last side.

The pillow may also be made of two separate woven pieces 10" X 12". In this case, if the set-up of loom does not provide 24" for strap, you may piece two 12" lengths together.

Another way of cutting material, is to set loom up to weave material 14" wide, then cut as at H. Material will shrink to given size of 10" X 12".

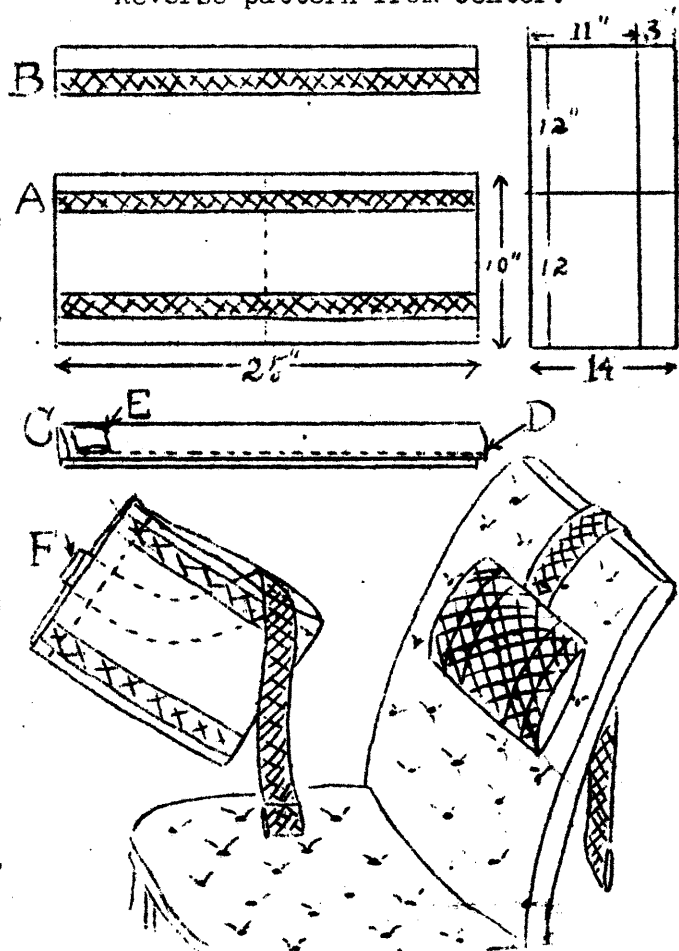

PATTERN: RUSSIAN DIAPER

Even if we do not partake of cocktails, smart little refreshment napkins are welcome at some time in every home. Two types are given here and one the following page: one with colonial pattern borders, the other with just plain colored stripes in bright cheery colors.

COLONIAL PATTERN BORDER FOR NAPKINS

RUSSIAN DIAPER

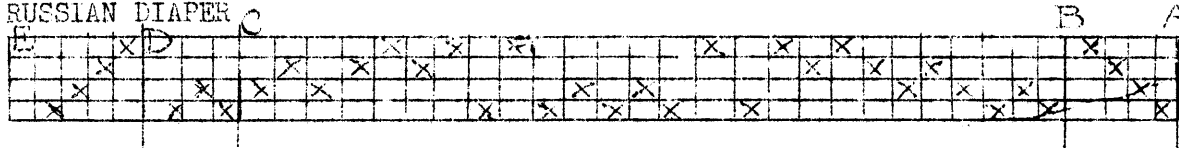

WARP PLAN

Width of warp: 20 inches
 No. thds. per in: 32 (or 30)
 Total no. thds: for 32 per in: 643
 for 30 " " 591
 Dent reed: 16 dent, 2 per dent
 or 30 dent, 1 per dent.

THREADING PLAN for 643 threads.

Selvage- 2x-----	8 threads
Pattern- B-C, 26 thds, 24 X--	624 "
3 extra thds., C-D-----	3 "
Selvage D-E-----	8 "
Total-----	643 "

Threading for 591 thds. same as above,
 but repeat pattern only 22 X.

WEAVING PLAN (Use two colors of thread for pattern, a dark and a light; binding thread or tabby, white or a pastel shade.)

<u>Pattern:</u>	Use the pattern
1-2	at the left as a
2-3 dark	border, on a back
3-4	ground of plain
4-1	weaving with white
	or pastel linen.
1-2	An economical way
2-3 light	to weave napkins is
3-4	to weave several at
4-1	a time across a wide
	warp. In this case,
1-2	weave two across the
4-1 dark	20" warp, cut in half,
1-2 (center)	as at A, stitch along

Reverse from here. edge, as at B, fringe as at C.

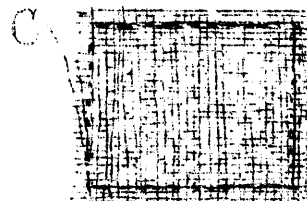
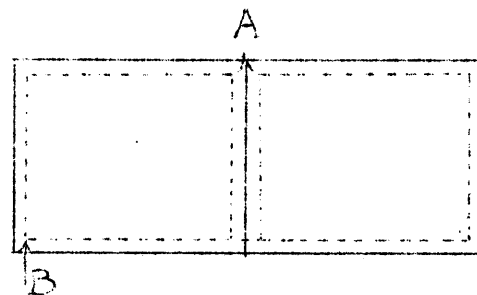
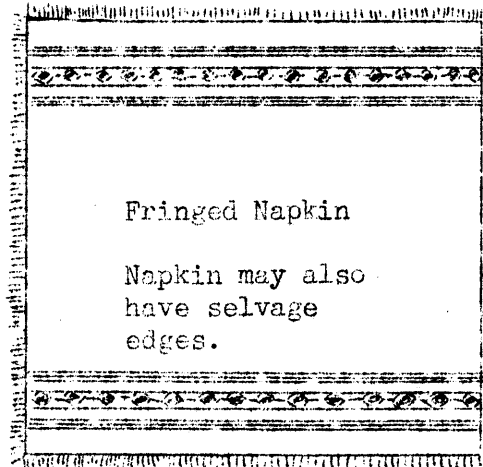

Note: In weaving your napkins, weave them longer than they are wide, for the warp shrinks when pressed.

MERCERIZED SUITING OR DRAPERIES

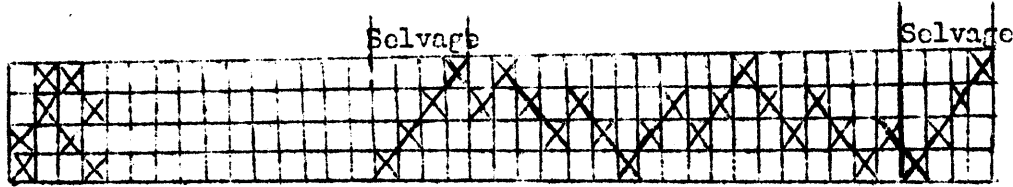

Weaving Draft

- 1 - 3
- 2 - 4
- 3 - 4
- 1 - 2
- Repeat

For Curtains--

Thread 24 per inch, or
2 per dent in a 12 dent
reed.

For Suiting--

Thread 30 or 32 per inch,
or 2 per dent in a 16 dent
reed.

When nature begins to show her good intentions to relieve the barren landscape with the first welcome spots of color--everyone takes the hint at once and we see now spring bonnets and derbys popping up about us like so many tulips or crocuses. Peering out through our freckled storm windows, we watch the perennial housekeeper gradually achieving a background of soft green, to further embellish her floral head-dress, and then it is that the faded colors of our worn winter households begin to show up. Of course, there is a moment's hesitation as to which shall come first,--the dressing up of the human or the house. And since there is a difference of opinion in this respect, we are giving this month a weaving pattern that does for both--or in other words, one that can be used for stunning light-colored spring suiting and summer coats, and also for a soft drapery for the living room or dining room.

Weave plain with a soft bouclet or wool for the dress apparel, and for draperies, use Perle No. 10 thread and weave with bouclet or Perle in three shades of a color, referring to the stripe designs of the last lesson.

We are enclosing in this issue cards for use in your weaving. These are available at 1¢ each.

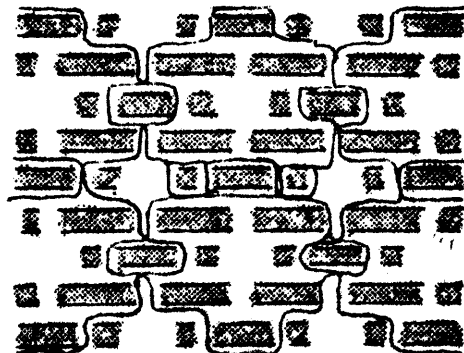

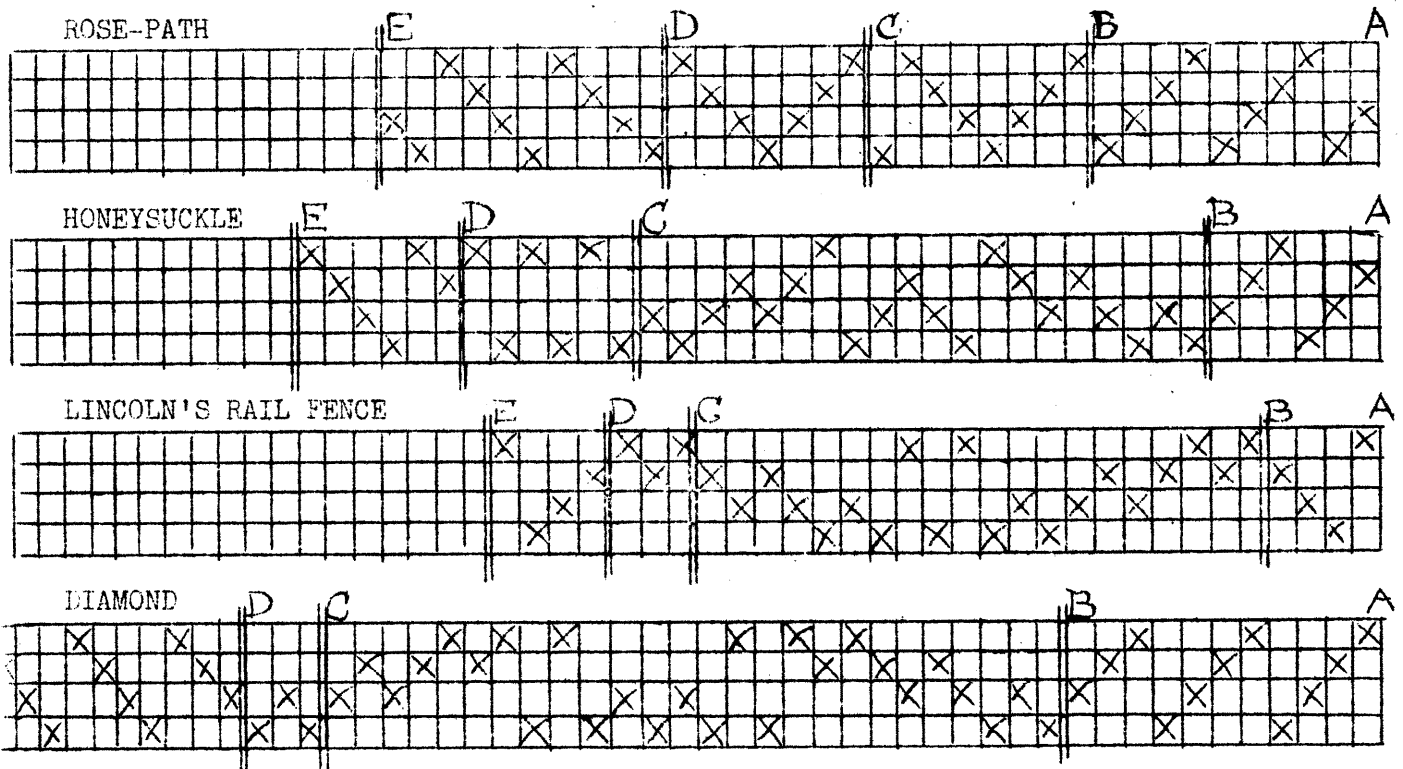

These small patterns may be used for the variations given on preceding page. They are all of the same general type, a motif that weaves up into the form of a diamond or oval.

WARP PLAN FOR ALL PATTERNS

Width in Reed: 19", weaves down to 18".

Dents per inch: 30 per inch, or 2 per dent in a 15-dent reed. You may also use a 16-dent reed with 2 per dent, but in this case the material woven will be 18" in reed, weaves down to 17".

Total no. of thds: 571.

THREADING PLANS

1. ROSE-PATH

Selvage: A-B-----	10	thds.
Pattern: B-C, 8 thds. (68 x)	544	"
Last time: C-D only-----	7	"
Selvage: D-E-----	10	"
Total-----	571	"

3. LINCOLN'S RAIL FENCE

Selvage; A-B-----	4	thds.
Pattern: B-C, 20 thds (28 x)	560	"
After last time: add C-D--	3	"
Selvage: D-E-----	4	"
Total--	571	"

2. HONEYSUCKLE

Selvage: A-B-----	6	thds.
Pattern: B-D, 26 thds (20 x)	540	"
Last time, B-C only, 20 thds	20	"
Selvage: D-E (skip C-D)---	6	"
Total-----	572	"

4. DIAMOND

Selvage: A-B-----	11	thds.
Pattern: B-C, 26 thds (21 x)	546	"
After last time, add C-D--	3	"
Selvage; D-E-----	11	"
Total-----	571	"

Send for Thread Chart
All kinds of threads: linens, cottons, wools, in all colors.