

Encyclopedia Diderot and d'Alembert

Weaving Plates

Part VIII Finish treatment/Apprêts

Being realized by Philippe DEMOULE

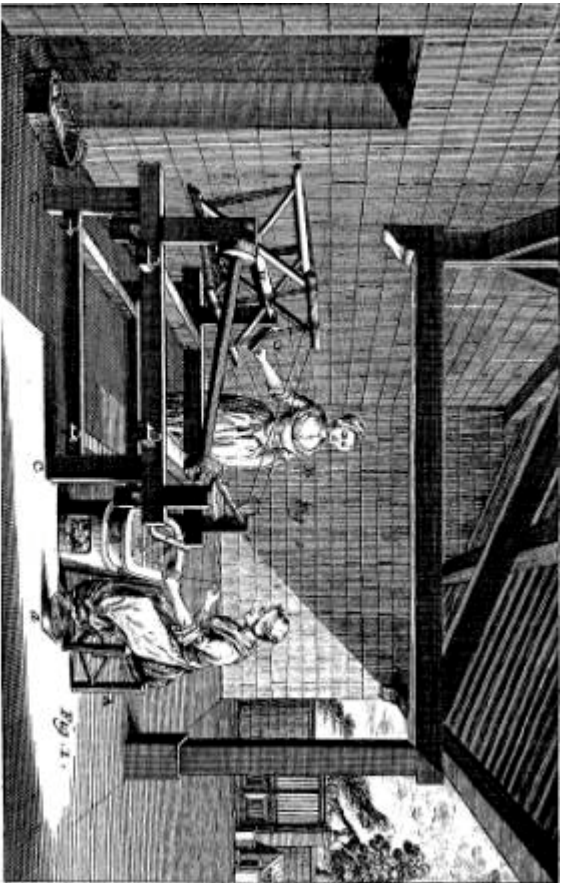

Fig. 1.

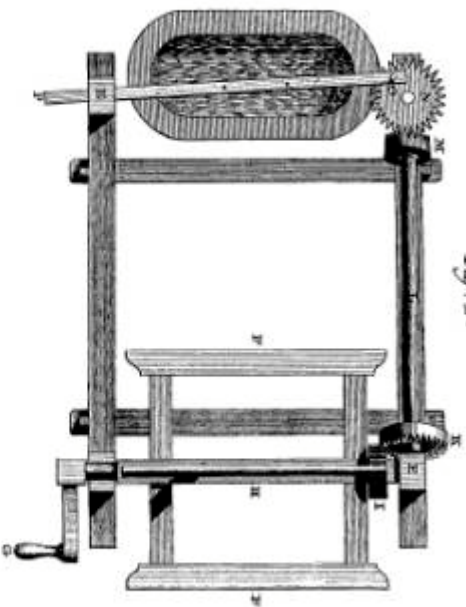

Fig. 2.

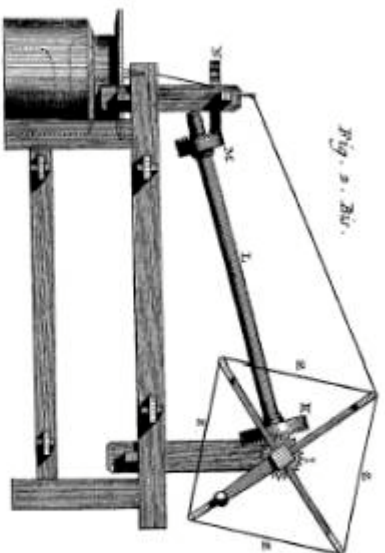

Fig. 3.

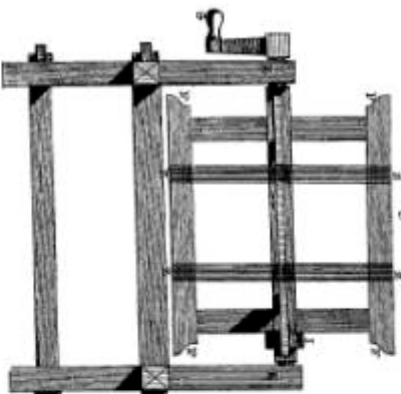

Fig. 4.

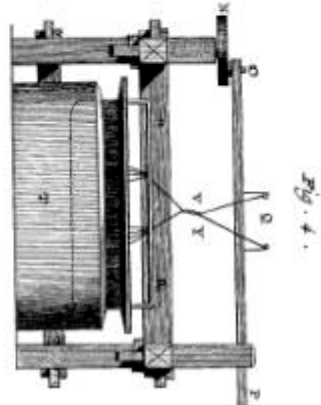

Fig. 5.



Fig. 6.

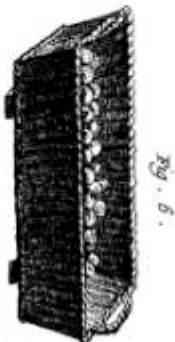

Fig. 7.



Fig. 8.



Soierie, Tirage de la Soie et Plan du Tour de Pérouse.

Soierie, Dveloppemens du Tour de Pérouse.

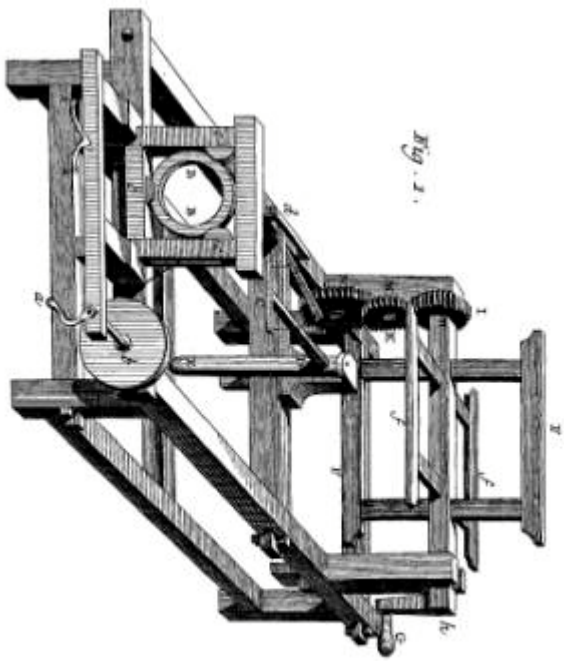

Fig. 1.

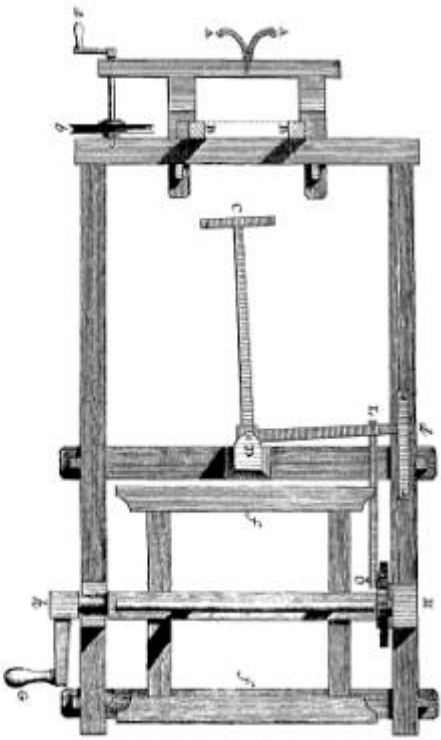

Fig. 2.



Soierie, Tour de M^r de Valenciennes.

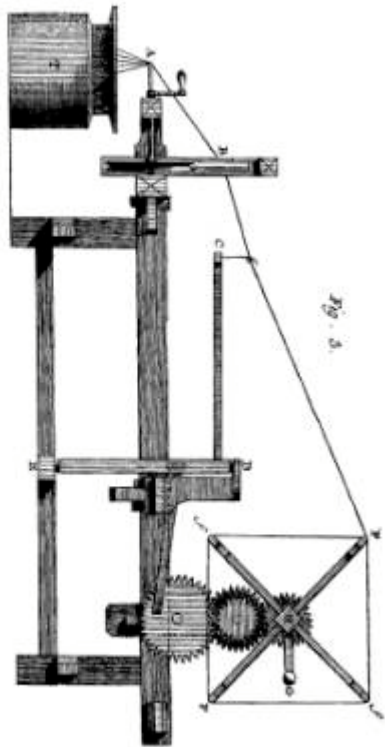

Fig. 3.

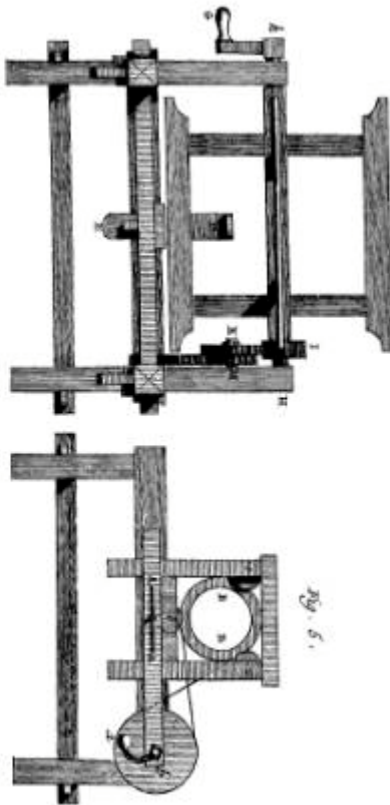

Fig. 4.

Fig. 5.

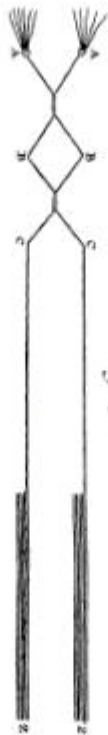
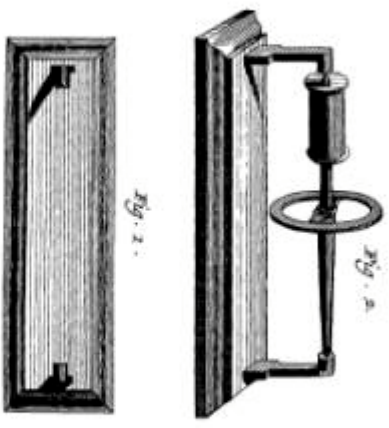
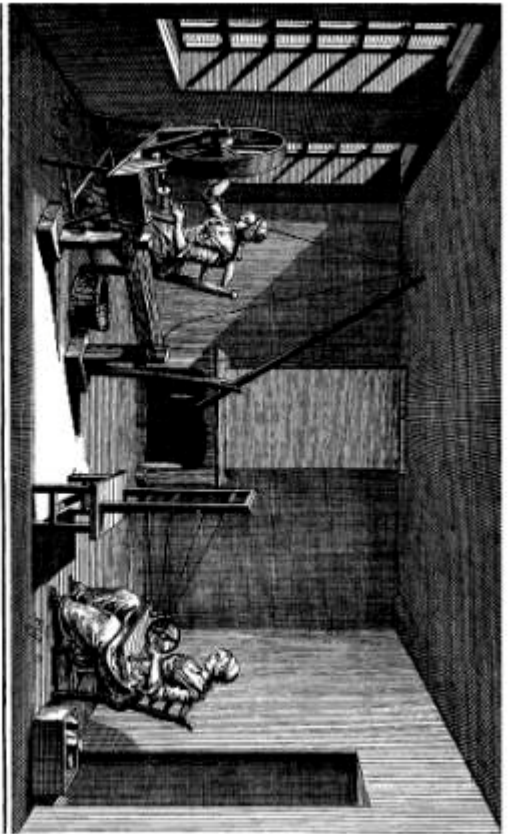

Fig. 6.



Soierie, Développement de Tour de M^r de Valenciennes.



Soierie, Dévidage de la Soie sur le Tour d'Espagne, Travailage au Développement de l'Arcaclon.

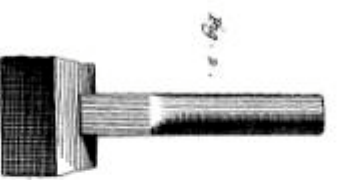
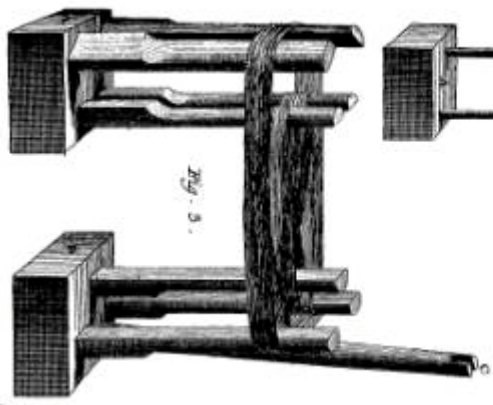
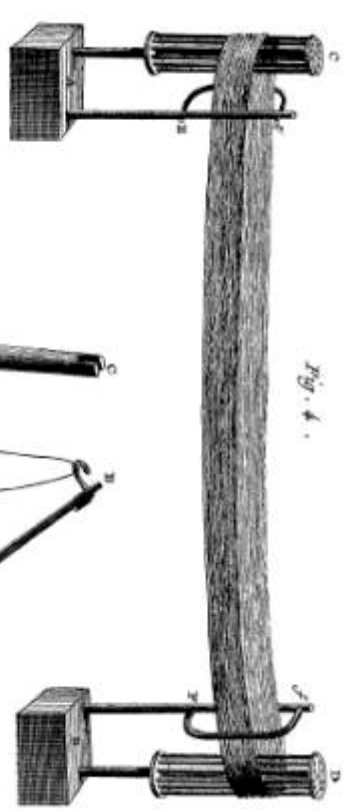

Soierie, Dévidage de la Soie, Tour d'Espagne, Composés à.

Soierie, Doublage des soies, Construction du Reux.

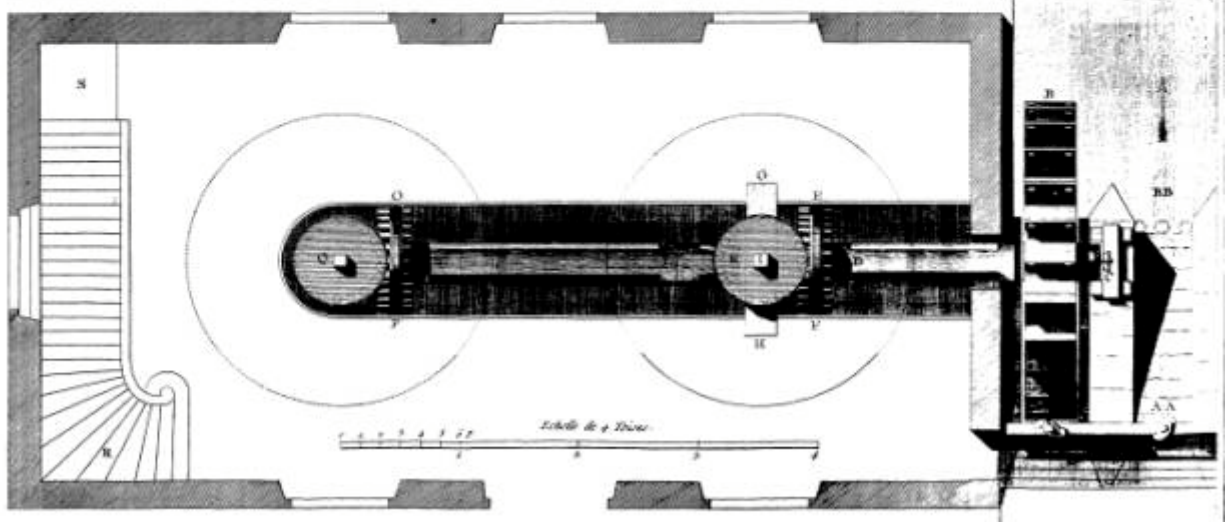
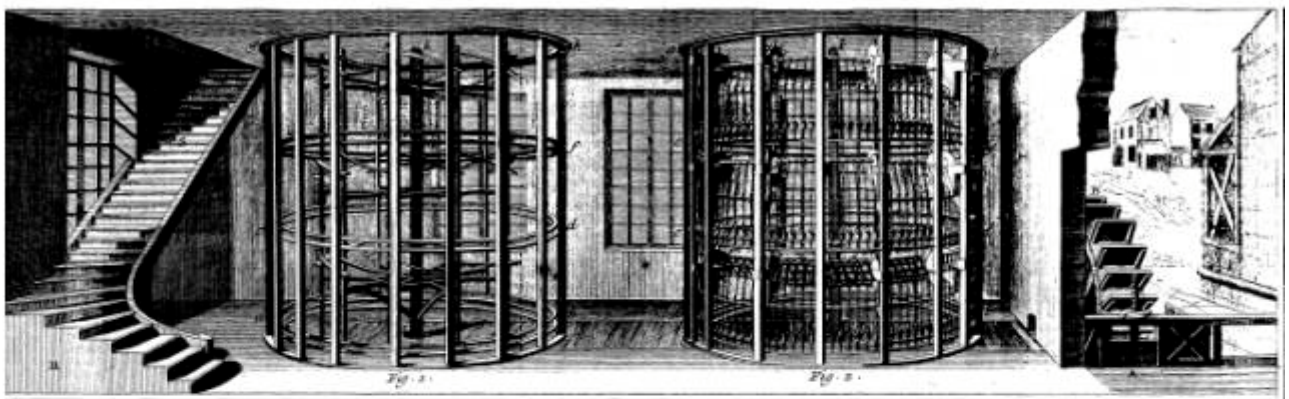
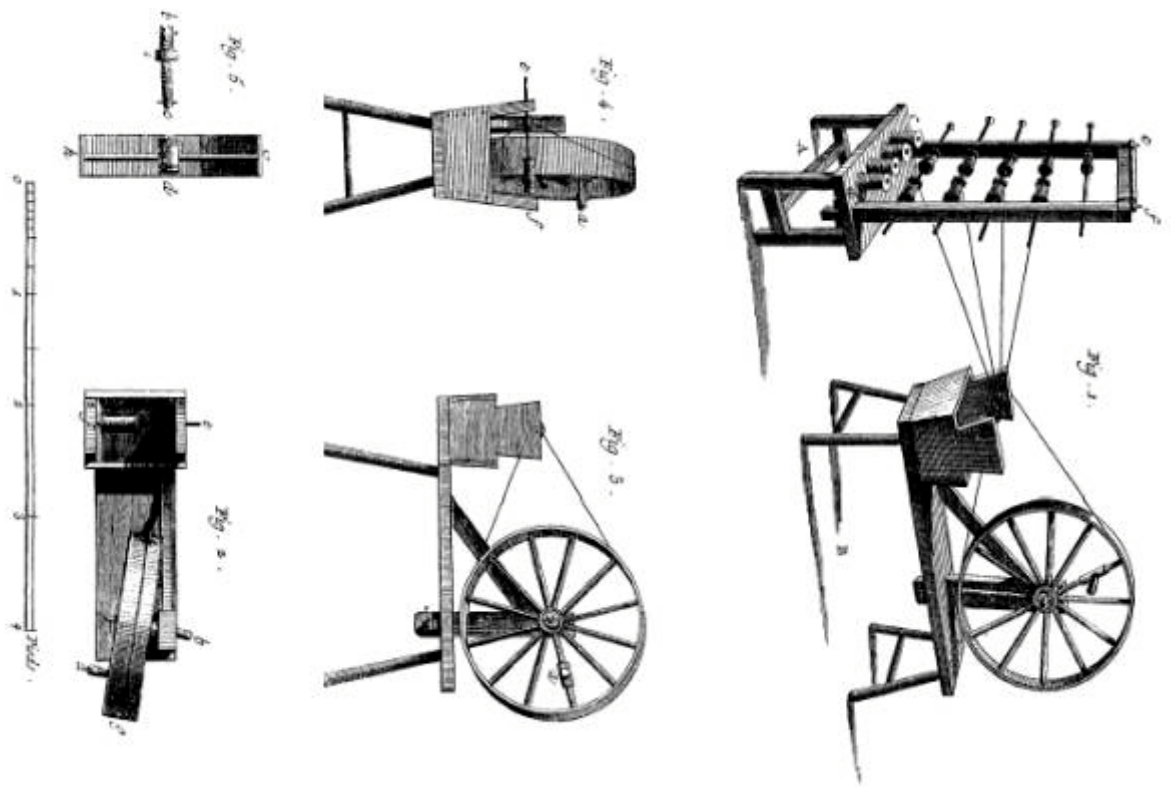

Soierie, Moulins de Piedmont en Perspective, et Plan de la Mécanique au-dessous du Reux de Choubée.

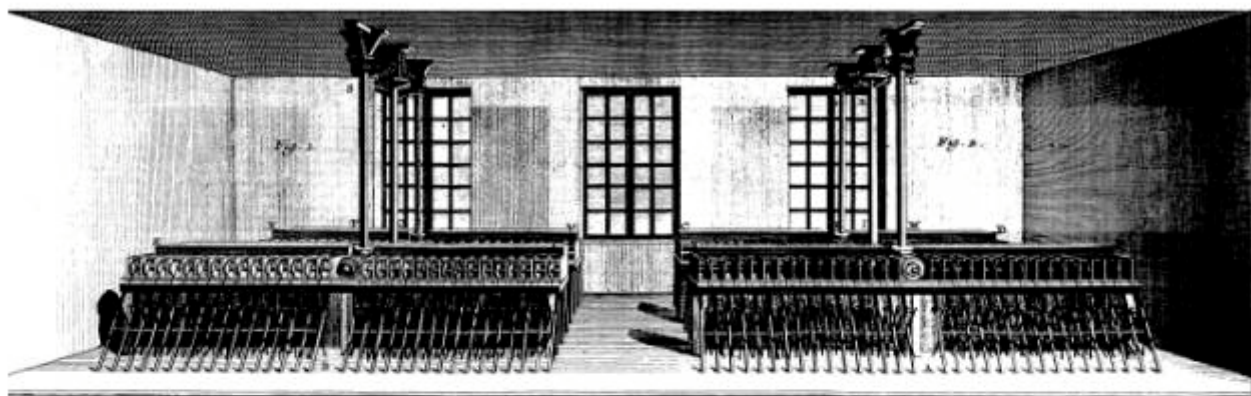
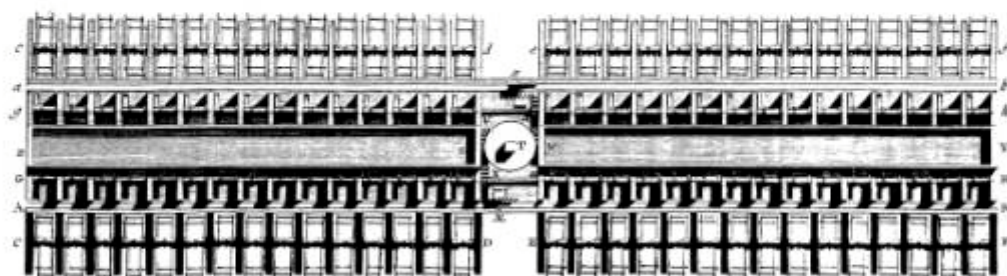
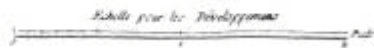
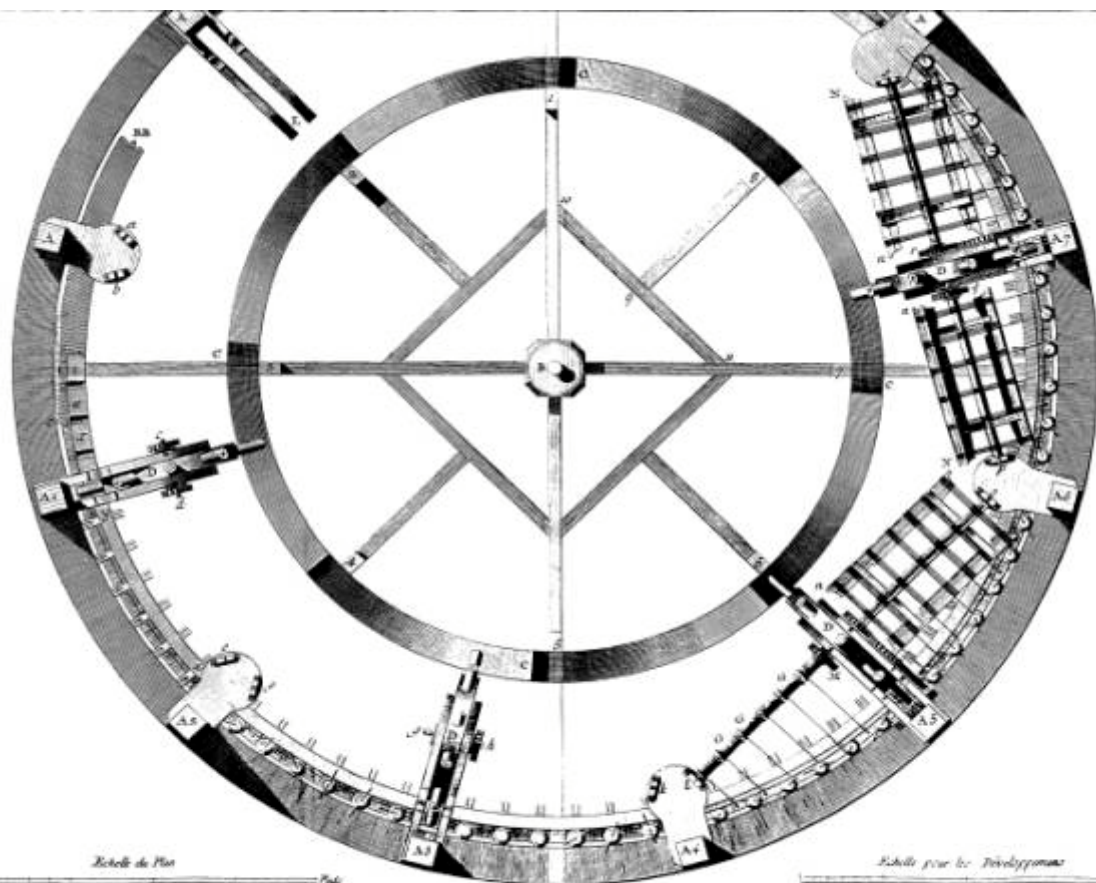

Fig. 3.



Soierie, Elevation perspective d'un grand Dévidage placé au dessus des Moulins représentés cy devant



Soierie, Plan du Moulin de Pérouse, à Strassbourg pour Organiser les Soies.

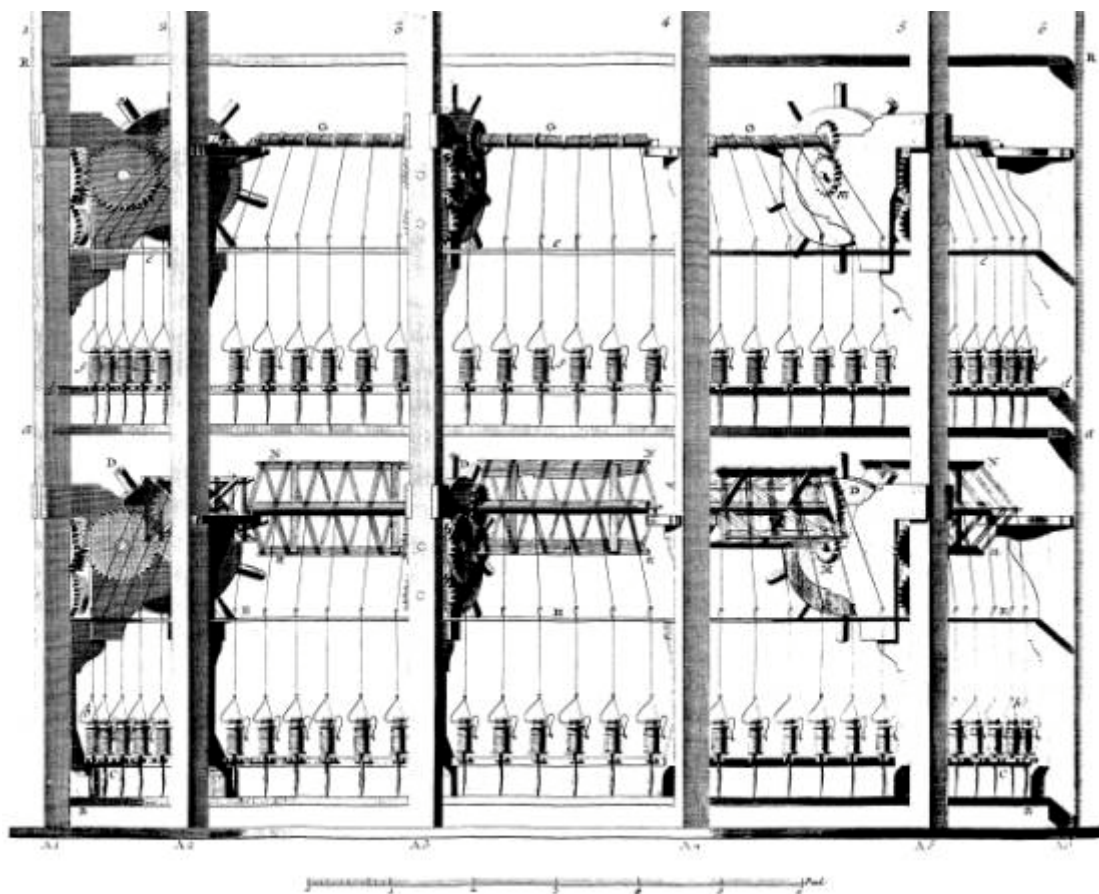

Soierie, Elevation Géométrale du Moulin de Pérou, pour Organiser les Cages.

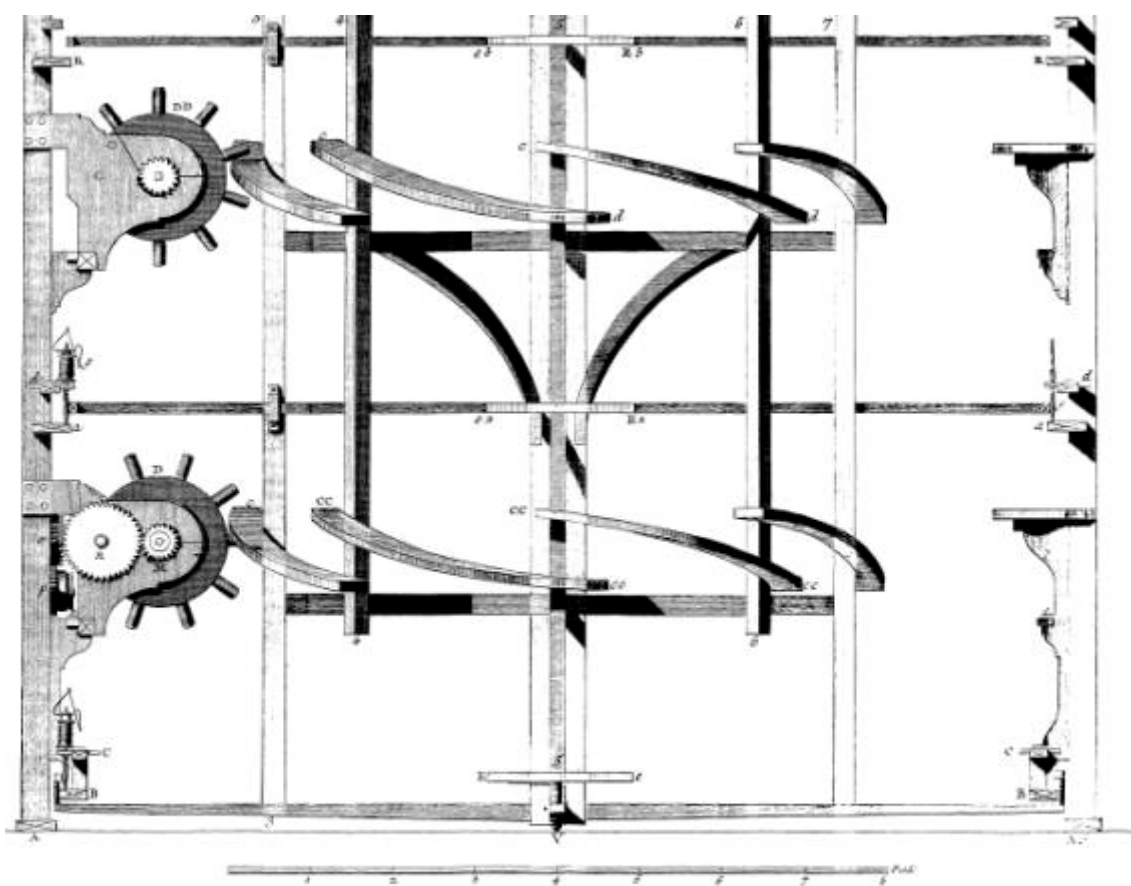

Soierie, Coupe Diamétrale du Moulin de Pérou et Elevation de la Lanterne qui est dans l'Intérieur.

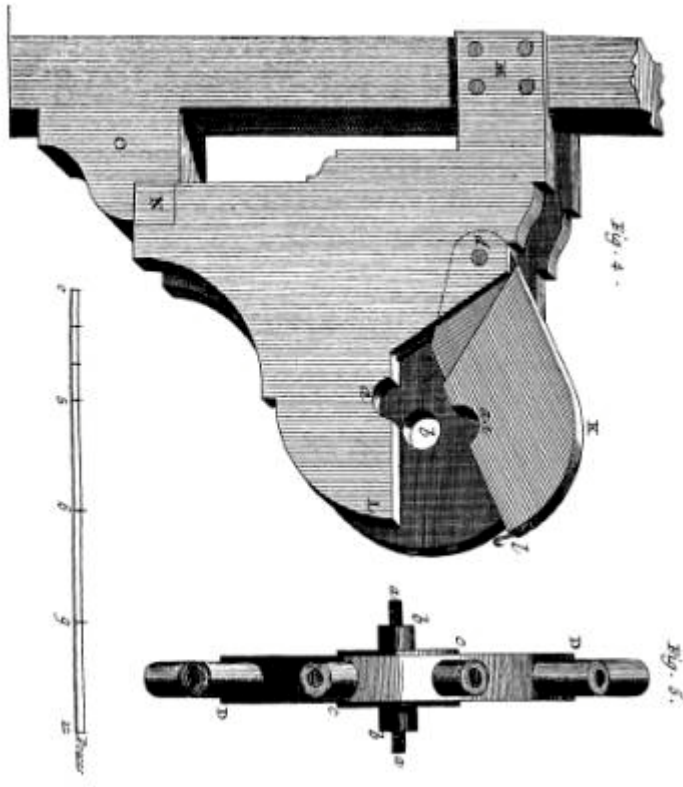
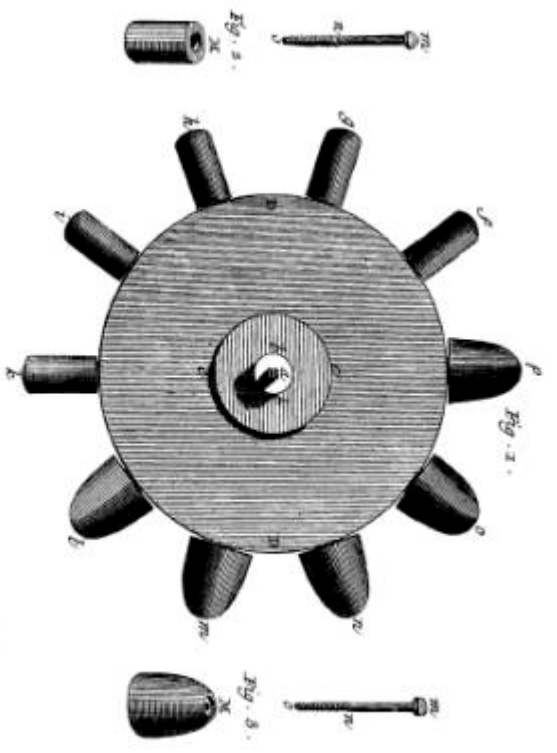

Soierie, Moulin de Peignoir pour Organiser les Soies, Construction et Développement des Pignons.

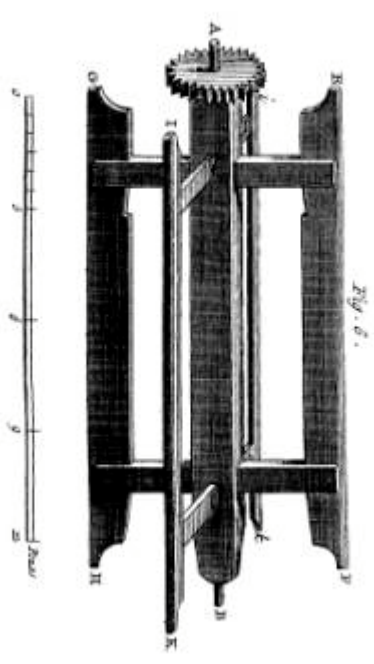
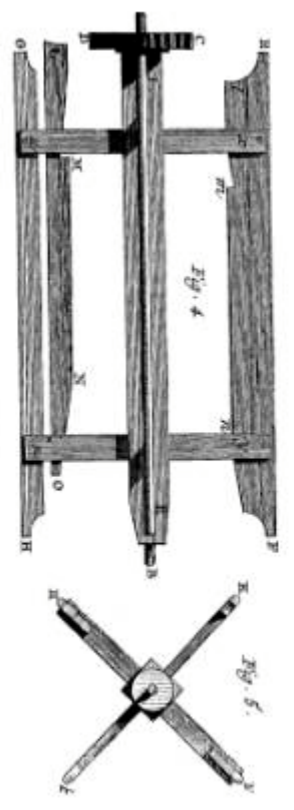
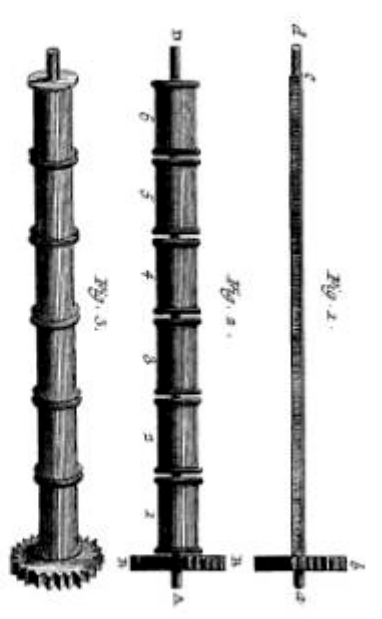

Soierie, Moulin pour Organiser les Soies, Construction et Développement des Aigles.

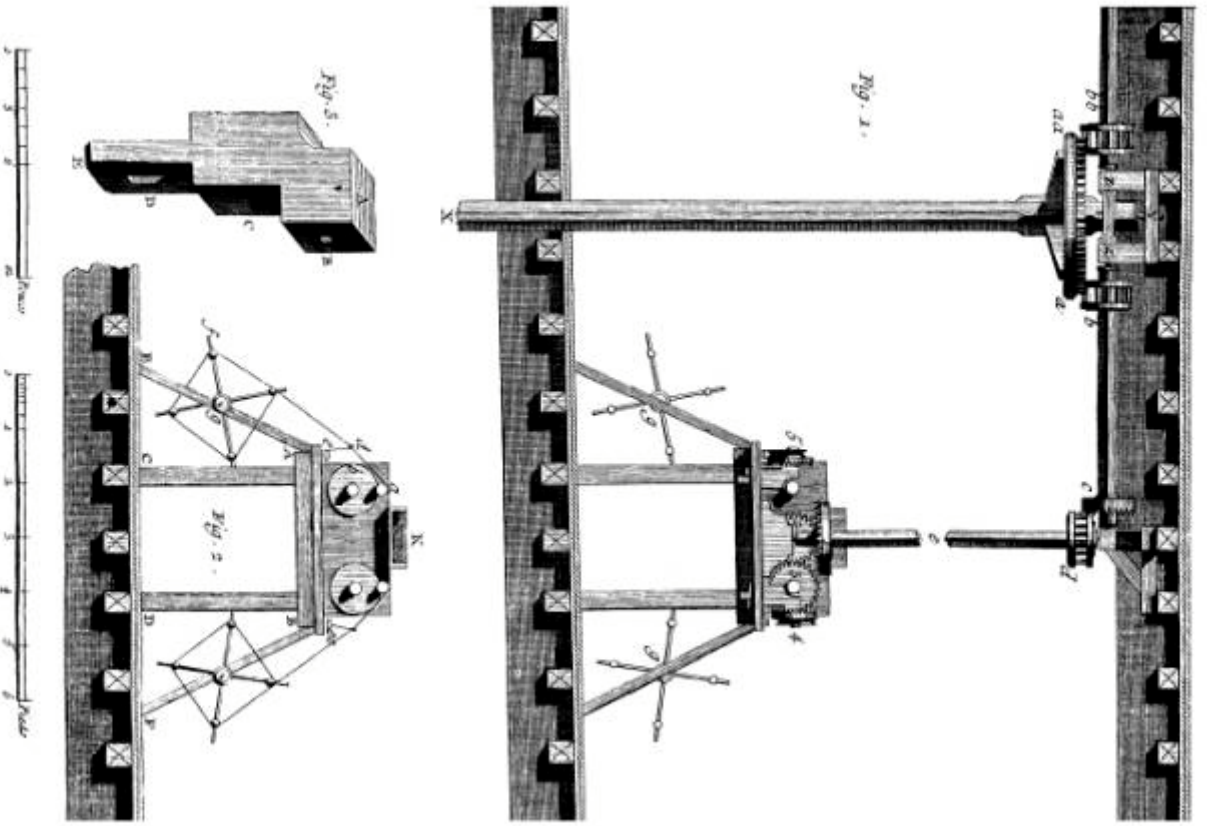

Soierie, Profil du Dessilage qui est en haut des Moteurs à l'égouttoir de soie

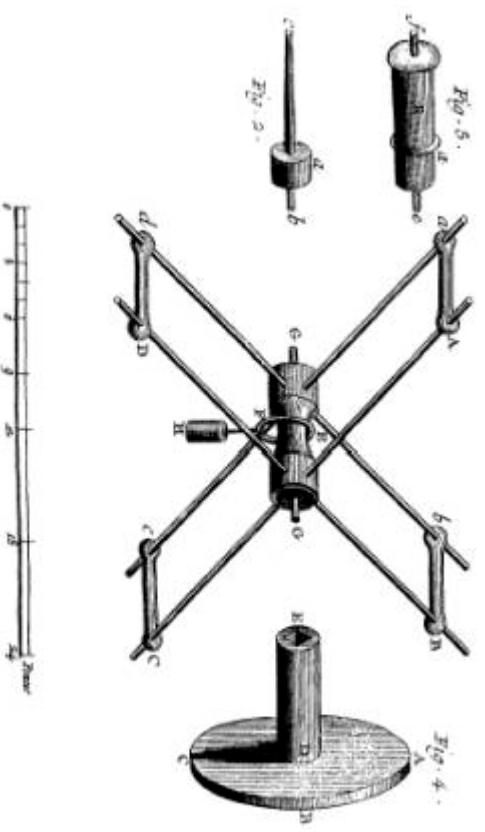
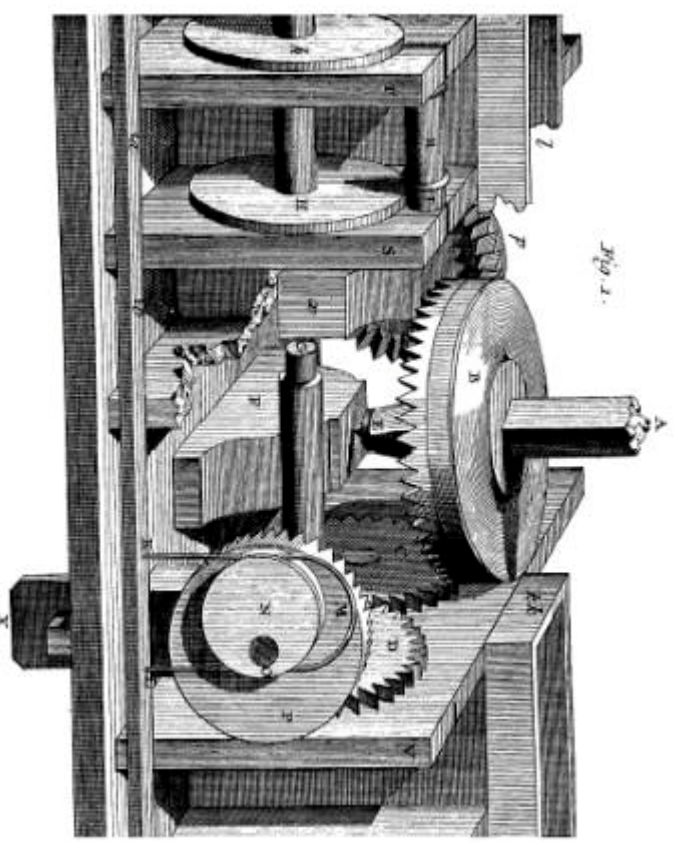

Soierie, Développement du Ta- et Vent du Dessilage &c.

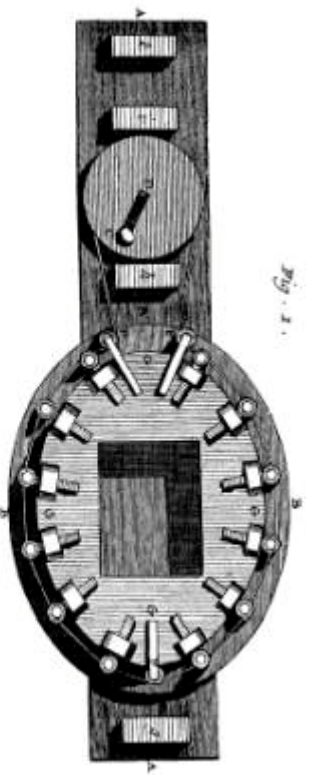

Fig. 1.

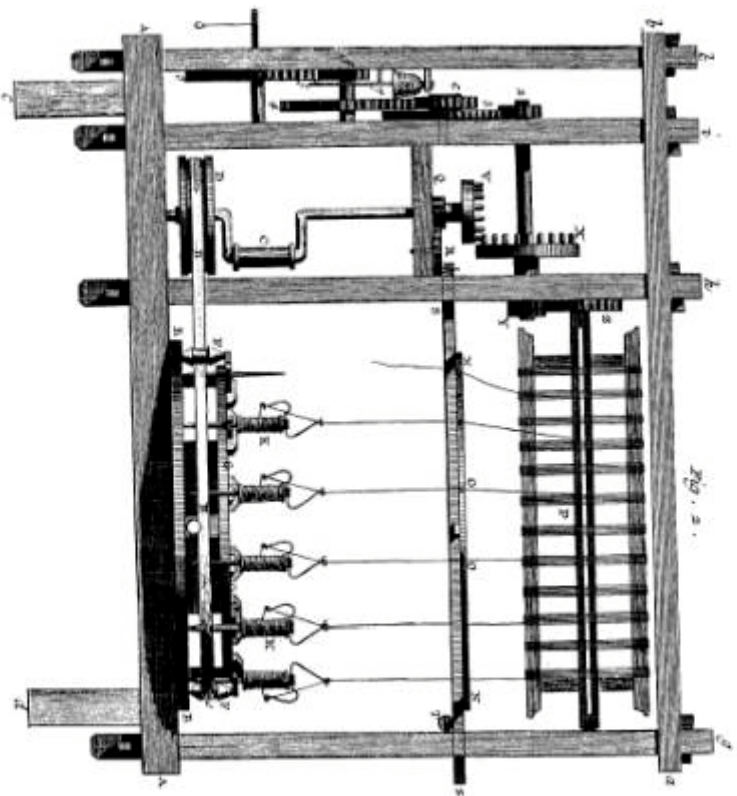

Fig. 2.

Soierie, Ovale. Plans et Elevations



Fig. 7.



Fig. 5.

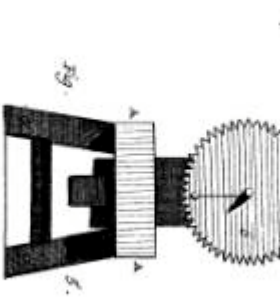

Fig.

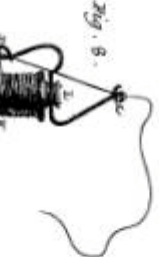

Fig. 8.



Fig.

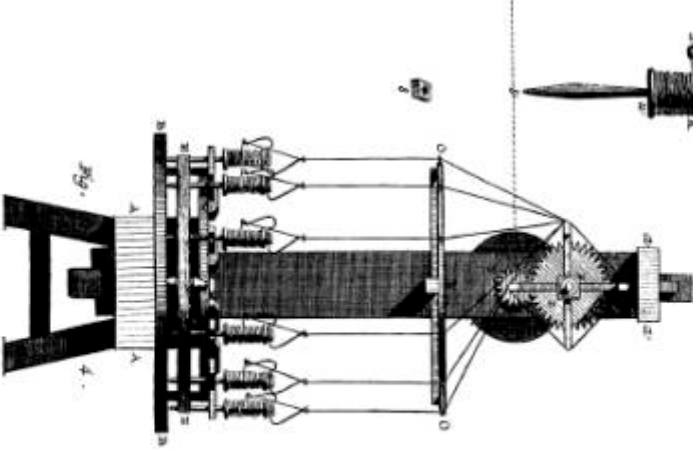
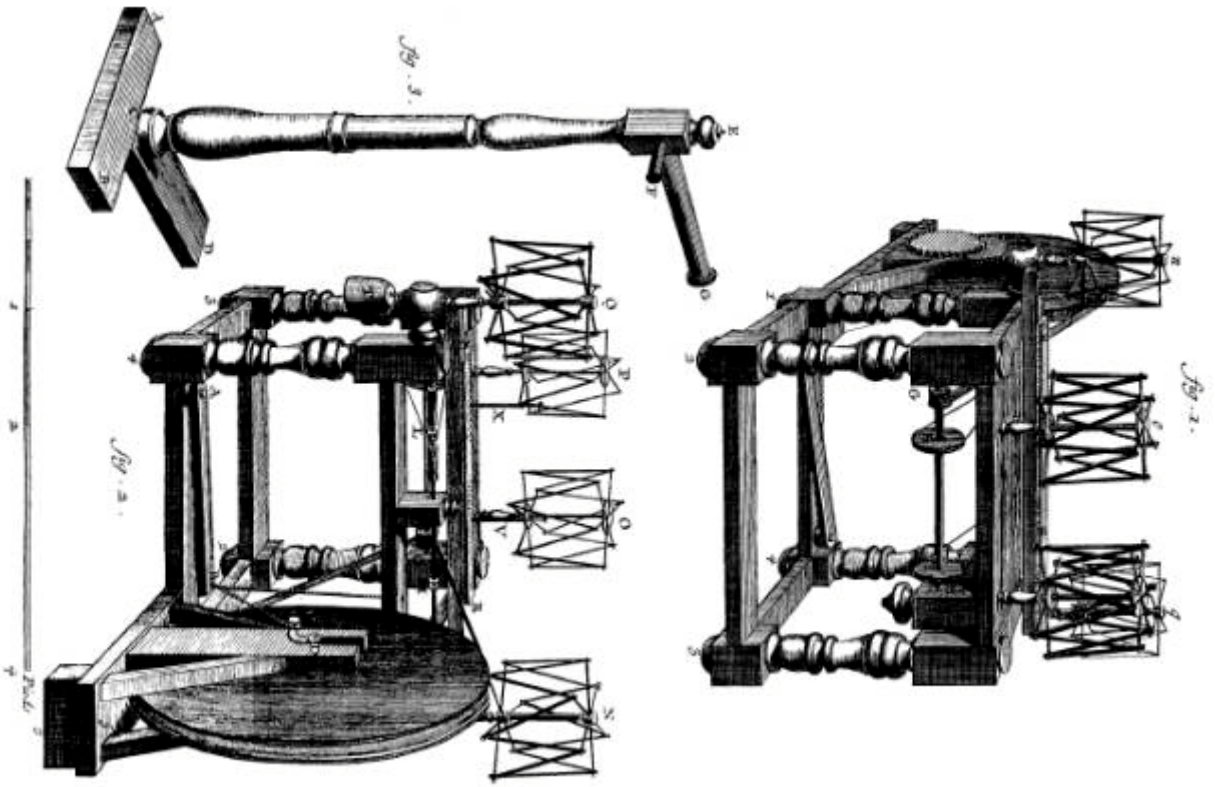

Fig.

*Soierie, Ovale, Coupes Transversales
et Developpemens de plusieurs Parties.*

Soierie, Rouet de Lion ou Perceuse vu des deux côtés.



Soierie, Rouet de Lion, Développement.

