

RAPHIA AND REED
WEAVING
INCLUDING ALSO
CARDBOARD AND PAPER CONSTRUCTION

A PRACTICAL COURSE FOR PRIMARY AND
ELEMENTARY SCHOOLS

By **ELIZABETH SANBORN KNAPP**

*"Head you may think; heart you may feel
But hand, you shall work always."*

Seventeenth Thousand



MILTON BRADLEY COMPANY
SPRINGFIELD, MASS.

NEW YORK PHILADELPHIA ATLANTA SAN FRANCISCO
1916

Copyright, 1901, by
Milton Bradley Company,
Springfield, Mass.

PREFACE.

The object of this book is to give to class teachers a complete series of models arranged in graded sequence, and extending from the Kindergarten to the grammar grade.

Though well aware that no book can be a substitute for an efficient instructor, efforts have been made to give the operations in minute detail in order to assist those teachers who, untrained in manual work, appreciate its value as an educational factor, and believe that the development of the senses, touch included, and the training of the hand in artisanship, must be the root of mind growth.

This book is the outcome of many years' experience in teaching and study, whereby the need was felt for such a series of elementary models as could be worked out in the class room by the class teacher, and its chief object is to show that hand training should and can be introduced in the Kindergarten and continued, without the usual break, into the High School. Although the models are not arranged in correlation with any particular subject, here may be found the basis from which can be constructed such objects as are adapted to any subject taught. No teacher should feel confined to a certain set of models, yet there must be such a development in the gradation as will make the work easy and delightful to the young pupils, and the articles made of such form and nature, and so systematically arranged, that there will be a steady growth in all phases of the work, and thus the child's instinct for activity satisfied and cultivated, and pleasure excited in the acquisition of skill.

CONTENTS.

| | PAGE |
|--|------|
| OUTLINE COURSE IN CONSTRUCTIVE WORK..... | 5 |
| INTRODUCTION | 7 |
| CONSTRUCTION IN PAPER—SERIES I..... | 9 |
| FREE WEAVING—SERIES I..... | 18 |
| CONSTRUCTION IN PAPER—SERIES II..... | 25 |
| CONSTRUCTION BY MEASUREMENT | 34 |
| FREE WEAVING—SERIES II..... | 38 |
| CONSTRUCTION IN CARDBOARD—SECOND YEAR..... | 44 |
| REED WEAVING | 63 |
| CONSTRUCTION IN CARDBOARD—THIRD YEAR..... | 77 |
| COURSE IN RAPHIA..... | 99 |
| RAPHIA WITH SLATS, WIRE, ETC..... | 111 |

OUTLINE COURSE IN CONSTRUCTIVE WORK.

GRADE, ELEMENTARY FIRST. TWENTY MINUTES DAILY.

| SUBJECT. | MATERIAL. | MODEL. |
|----------------|-----------------------------|--|
| Measurement.. | Rulers, spaced one inch. | Lines and geometric forms. |
| Free Weaving. | Paper strips one inch wide. | Gifts, such as boxes, baskets, frames, cornucopia, etc. |
| Construction.. | Paper folded into squares. | Seed and flower boxes and baskets, colonial furniture, tents, canoes, etc. |
| Knot Work.... | Cotton Twine. | Horse lines and whip, chain for whistle. |

GRADE, ADVANCED FIRST. TWENTY MINUTES DAILY.

| | | |
|----------------|--|--|
| Measurement.. | Rulers spaced one-half inch. | Geometric forms, simple surface covering. |
| Free Weaving. | Paper strips one-half inch wide. | Gifts, as handkerchief box, napkin ring, blotters, etc. |
| Construction.. | { Paper, folded. { Oak tag, measured and cut. | { Parlor, kitchen, dining room furniture for dolls' houses. { Boxes, letter cases, etc. |

SECOND YEAR. THIRTY MINUTES BI-WEEKLY.

| | | |
|--------------------------------|---|---|
| { Measurement and Construction | { Rulers spaced one-quarter inch and colored bristol board. | { Wall pockets, portfolios, pocketbooks, etc. { Boxes and envelopes for school use. |
| Weaving..... | { Reeds, pith, raphia, wire and with the loom. | { Mats, trays, baskets of various shapes and sizes. { Strips for carriage covers, etc. |
| Toy Making.... | Glass, tin, spools, thin wood, etc. | Kaleidoscope, bandilore, shelf, jumping jack, etc. |

THIRD YEAR. TWENTY MINUTES WEEKLY.

| | | |
|--------------------|-------------------------------|--|
| Construction | Straw board, jute board, etc. | Portfolio, boxes covered, match safe, etc. |
|--------------------|-------------------------------|--|

ONE HOUR WEEKLY.

| | | |
|--------------------|---|--|
| (Girls) { | Raphia, braided and sewed. | Mats, bags, belts, doll hat, bonnets, etc. |
| Construction | { Advanced knot work. | { Hammocks, shepping bags, etc. |
| (Boys) { | { Wood (at bench) and Working drawings. | |

FOURTH YEAR. ONE HOUR WEEKLY.

| | | |
|--------------------------------|----------|---|
| Sewing (Girls) | | Bags, aprons, sofa pillow (out-lined), skirt, waist, etc. |
| Woodwork and Working Drawings. | { (Boys) | |

FIFTH YEAR. TWO HOURS WEEKLY.

| | |
|-----------------------------|-----------|
| Cooking..... | { (Girls) |
| Woodwork..... | { (Boys) |
| Bent-iron and Wood Carving. | { |

THIRD YEAR—WOOD WORKING. FOURTH YEAR—WOOD WORKING.

- | | |
|--|---|
| 1. Boxes for window gardening. | 1. Box, square joint, for window gardening. |
| 2. Cat and bat. | 2. Box, planned by pupils. |
| 3. Ring and ball puzzle. | 3. Making Bench hook. |
| 4. Game of dart. | 4. " Nail box. |
| 5. Jumping Jack—I. II. | 5. " Plant rack. |
| 6. Whistle—I. II. | 6. " Bracket. |
| 7. Rack for "egg farm" (for nature study). | 7. " Shelf. |
| 8. Butterfly press. | 8. " Loom, for use in Second year. |
| 9. Color whirligig. | 9. " Weather vane. |
| 10. Pencil box. | 10. " Work box. |
| 11. Swing for doll. | 11. " Stool. |
| 12. Dominoes and box. | 12. " Wheel-barrow. |
| 13. Weather vane. | 13. " Christmas tree stand. |
| 14. Ring toss. | 14. " Cart. |
| 15. Stilts. | 15. " Water wheel. |
| 16. Ant nest. | 16. " Key rack. |
| | 17. " Bird house. |

FOURTH YEAR. SEWING.

Practice work on unbleached muslin; running, over-handing, stitching, two runs and a back stitch, and hemming stitch.

Practical application: holders, cooking caps, sewing aprons, work bags, dusters, dish cloth, sofa pillow, (covers cross-stitched,) muslin undergarments and shirt waist, refooting and darning of stockings.

Talks on weaving of cloths—explanation of warp.

FIFTH YEAR. WOOD WORKING.

1. Making plant box. (Use of rip and crosscut saw.)
2. Marble board. (Chisel exercise.)
3. Bracket. (Practice with spoke shave.)
4. Ladder, or water-tight box. (Application of housed joint.)
5. Plant stand. (Application of halved joint.)
6. Making round stick. (Ruler.)
7. Knife box.
8. Making bird house. (Brace and bit exercise.)
9. Letter rack. (Decoration, carving.)
10. Stool. (Use of bevel square.)
11. Handkerchief box. (Decoration, chip carving.)
12. Glove box. (Carved, relief.)
13. Shelf. (Decoration, bent iron.)
14. Picture frames. (Decoration, pyrography.)
15. Strong box. (Metal bound.)
16. Newspaper rack. (Carved.)
17. Spool box. (Hinged cover, decorated.)
18. Sun dial.
19. Plumb bob.

INTRODUCTION.

In order to secure exactness in construction in cardboard or wood the pupil must be taught to read and intelligently use the ruler, and in the foregoing series of lessons two periods per week are devoted to instruction in measurement.

But ten minutes are given to the first lesson. The idea of measuring, by inches, having been well developed by using inch sticks and tablets, the pupils are provided with rulers marked off in one-inch spaces, and these, together with the sticks, furnish material for many additional lessons, the child being taught to measure from any given point on the ruler in either direction. This development should not be hurried; exercises in judging and then testing measurements of various tablets and objects should be given, and results should be satisfactory, if at the end of first school year the pupils are able to space and rule both horizontal and vertical lines, and cut strips of paper to given lengths.

Variety and pleasure are given by using black pencils for spacing and colored ones for ruling the lines. The idea of one-half inch is introduced into the work of the next year (*advanced first*), beginning with the ruling of parallel lines, then drawing to measurement various rectangular figures, introducing in the latter part of the school year the development of simple folding boxes. This work is carried on through the second and third year, by a succession of graded models made up in various materials.

For all cardboard work the Essex bristol is used. This is comparatively inexpensive and may be secured in a variety of colors. Portfolios, frames, pocketbooks, etc., are covered

with leatherette, and a heavy quality of book-cover paper is used for the construction of many of the models.

One period per week is taken for weaving. Harmonious combinations of two colors of book-cover paper, cut into strips one inch wide for elementary first, and one-half inch for advanced first, form the basis; and from this are constructed napkin rings, baskets, picture frames, and boxes of various shapes and sizes.

In the second and third year reeds and raphia are furnished, and by combinations of both of these, many easily constructed gifts, such as mats, baskets, chairs, etc., can be made and preserved for use at Christmas or Easter time.

Two periods per week are given to lessons in construction—the material for first two years being various shades of “bluefiber” or “eel-skin” paper, cut into squares 6" x 6" and folded into most delightful forms, complete sets of furniture for dolls' houses being easily made by little fingers. This paper creases easily, retains its shape and is very inexpensive, thirty cents covering all cost for a class of fifty, twenty models for each child.

Variety is given to the work of the second year by using glass, cardboard, thin wood, or tin, in the production of kaleidoscopes, bandillores, jumping-jacks, swings, etc.

The boy in third year is eager and well-fitted to take up bench work, and the girl to be initiated into the cutting and making of dolls' garments; from now on the manual training teacher finds his pupils equipped with a fund of knowledge which will prove helpful in the making and understanding of working drawings.

CONSTRUCTION IN PAPER.

Series I.

ELEMENTARY FIRST GRADE.

Time twenty minutes bi-weekly.

The following models are based on the folded square, and constructed from a stiff quality of fiber, manila, or hercules cover paper, the latter being most expensive. In the diagrams, the light lines indicate folds, the heavy lines, cuts.

In giving these lessons the teacher should place the lines on the board as she dictates the folding, first drawing a large square to represent the square of paper, then the horizontal diameter for first fold, indicating each additional fold by a new line. After all folds have been indicated in the drawing with white crayon, show with colored crayon the lines to be cut, and by erasing lines, show which squares are to be cut out.

Variety can be given to the manner of presenting the lesson by requiring pupils to work from the drawing only, without dictation, each new line drawn indicating a step in the work. Power is thus given to the child to enable him to interpret readily the more difficult drawings which he will meet when he works from measurement.

Not more than twenty minutes should be given to each lesson; and as it will take two periods to develop some of the models, time may be saved by providing each pupil with a portfolio, made from oak tag, in which he may place his unfinished work and waste pieces, all of which are to be saved and utilized in the making of the different models. The mucilage may be placed on several small dishes on a table, each child, after showing his work properly folded, passing to the

table and pasting into shape. This is a more cleanly and a quicker way than to furnish paste for each child.

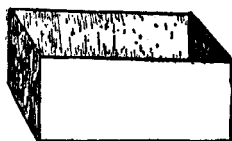

Model I. Square Box.

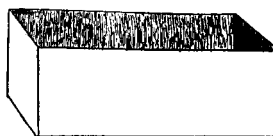

Model II. Oblong Box.

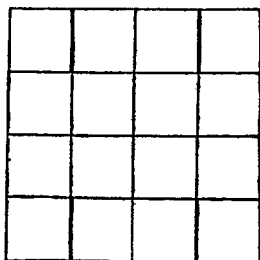

Fig. 1.

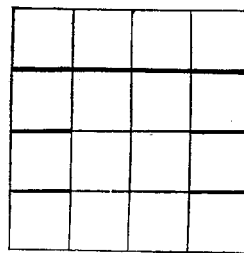

Fig. 2.

MODEL I. — SQUARE BOX.

Fold the paper into sixteen small squares. (See Fig. 1.) Cut in on the heavy lines, fold on the light lines. Fold into shape and paste, using mucilage.

MODEL II. — OBLONG BOX.

Cut off four squares on the right side or from top. (See Fig 2.) Indicate this on blackboard by erasing. Cut in on heavy lines, fold into shape and paste. Put the mucilage on both sides of the center square and bring the ends around, one inside and one outside the center.

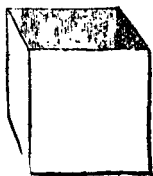

Model III. Cubical Box.

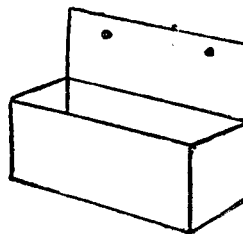

Model IV. Comb Case.

MODEL III. — CUBICAL BOX.

Cut as indicated by full lines, leaving nine squares. (Fig. 3.) Fold into shape and paste.

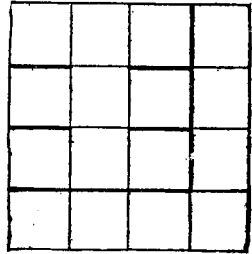

Fig. 3.

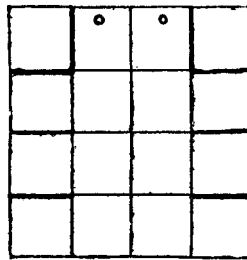
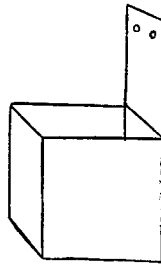

Fig. 4.

MODEL IV. — COMB CASE.

Cut out upper corner square. (Fig. 4.) Cut in on full lines and fold into shape. Perforate back for hanging.



Model V. Match Safe.

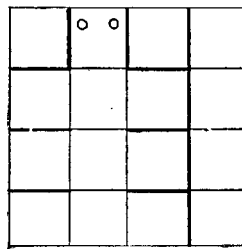
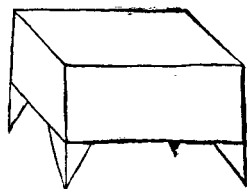

Fig. 5.



Model VI. Table.

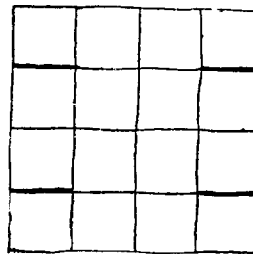

Fig. 6.



Fig. 7.

MODEL V. — MATCH SAFE.

Cut off four squares on the right side. (Fig. 5.) Cut out the upper corner squares. Cut in on the remaining full lines and fold into shape. Perforate for hanging.

MODEL VI. — TABLE.

Cut and fold as for Model I. (Fig 6.), using for legs the four squares cut away from Model V. (Fig. 7.) Fold each of these squares on the diagonal, and glue them into the corners of the inverted box. For the tablecloth, fold a piece of thin white paper into sixteen squares and then cut off about a quarter of an inch around the edge. The cloth may be fringed if desired.

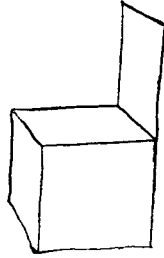

Model VII.

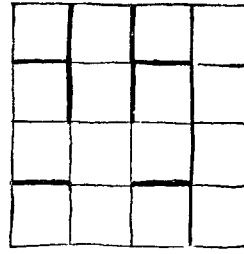

Fig. 8.

MODEL VII. — CHAIR.

Cut as indicated at Fig. 8. Fold the corner squares back, and bring the back of the chair up into position. Fold the remaining two squares back and strengthen the back of the chair by using the four squares cut away, folded through the width and glued to the back.

MODEL VIII. — LUNCH BOX.

Two squares of paper, 6 ins. x 6 ins. are required for this model. For the box construct as in Fig. 2, Model II.

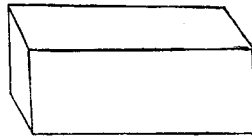

Model VIII. Lunch Box.

Pattern for the cover will be found in Fig. 10. For the curved lines trace around a one-inch semi-circular tablet.

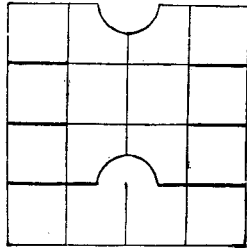

Fig. 10.

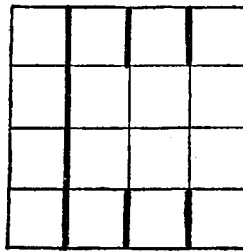
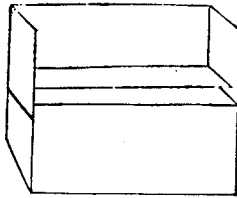

Fig. 11.



Fig. 12.

MODEL IX. — HALL BENCH.



Hall Bench.

But one square need be given to pupil for the construction of this model, as the piece cut from Fig. 11 will form Fig. 12.

Cut out corner according to diagram and then cut in for laps, fold into position and paste, using Fig. 12 for back and arms.

MODEL X. — SLED.

Cut off four squares as indicated in Fig. 13, then fold each outside square to half its width, and cut off the half at upper end, then fold back for runners and cut curved lines as indicated, using Fig. 14 for brace.



Model X. Sled.

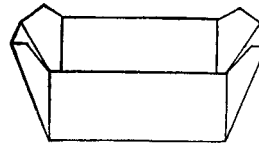

Model XI. Butter Dish.

MODEL XI. — BUTTER DISH.

But one square is needed for this model; fold and cut as indicated in Fig. 15, folding the diagonal edge back to *a* and cut off the projecting ends after pasting.

MODEL XII. — CORNER SHELF.

Fold and cut as indicated at Fig. 16, using for top of the shelf two of the squares cut away, curving this piece to suit the fancy of the pupil.

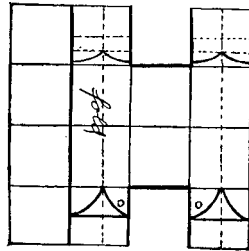

Fig. 13.



Fig. 14.

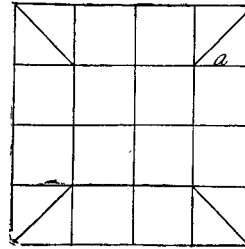
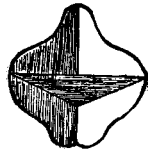
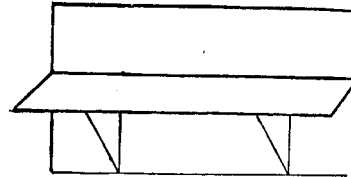

Fig. 15.



Model XII. Corner Shelf.



Model XIII. Side Shelf.

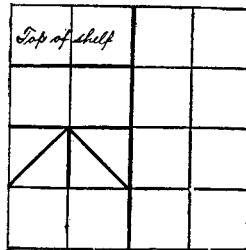

Fig. 16.

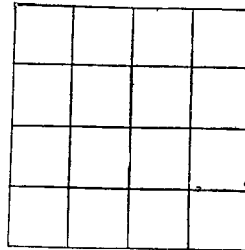

Fig. 17.

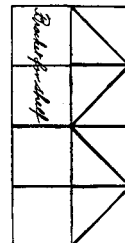

Fig. 18.

MODEL XIII. — SIDE SHELF.

But one whole square need be passed for this model, using for the brackets the piece cut away from Fig. 16.

Fold Fig. 17 on center line, and then fold up for top half and down for bottom half of the back, glue into shape and

then add the brackets which are to be cut and folded as indicated in Fig. 18.

MODEL XIV. — CHAIR.

Use one square for this model. Cut as indicated at Fig. 19, fold into position and paste. The paper may be so folded as to bring the two arms together and then cut into curves, if desired.

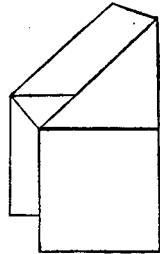

Model XIV. Chair.

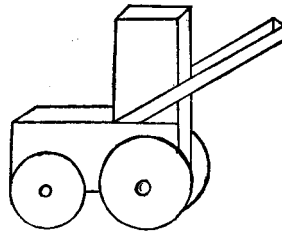

Model XV. Carriage.

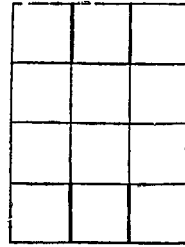

Fig. 20.

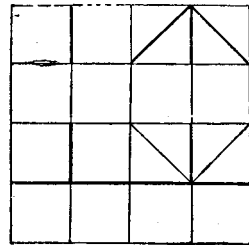

Fig. 19.

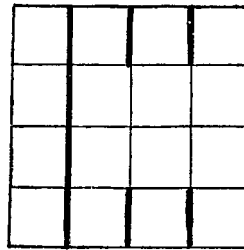

Fig. 21.



Fig. 22. Handle.



MODEL XV. — CARRIAGE.

Two squares will be required for this model. Fig. 23. The wheels may be cut from extra piece in Fig. 19. Cut and fold Figs. 20 and 21 as indicated. Use for the handle the pieces cut away, folding the handle double and making it eight squares in length. Glue this to shape and place in position before the top of the carriage is glued at the

sides. Use toothpicks for axles and peas for *hubs*. If the back wheels are made larger than the front ones, then the back axle must be placed higher than the front one.

MODEL XVI. — HOUSE.

But one square is used for this model. Cut and fold as indicated at Fig. 24, the dotted lines indicating a fold, into half widths; glue these folds back.

MODEL XVII. — COW SHED.

Fold and cut as indicated at Fig. 25. Glue into position and then cut off that part of the end which extends above the roof.

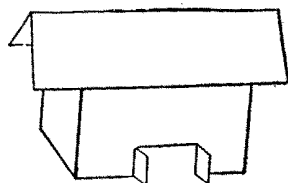

Model XVI. House.

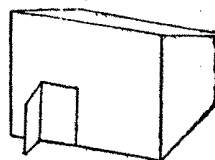

Model XVII. Cow Shed.

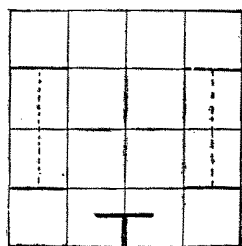

Fig. 24.

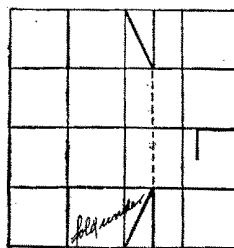
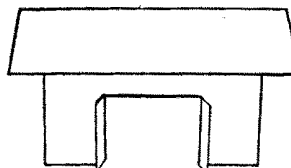

Fig. 25.

MODEL XVIII. — BARN.

Use two squares for this model. Cut and fold as indicated at Fig. 26. A roof may be added as indicated at Fig. 27.



Model XVIII. Barn.



MODEL XIX. — HEN COOP.

Cut as indicated at Fig. 28, folding the pattern as indicated by dotted lines before

Model XIX. Hen Coop. cutting out the slats.

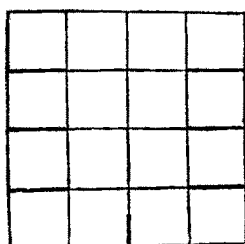

Fig. 26

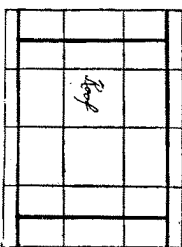

Fig. 27.

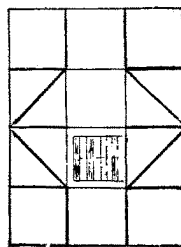

Fig. 28.

FREE WEAVING.

Series I.

ELEMENTARY FIRST YEAR.

Material required for entire course of twelve models, five sheets of 48-pound laid antique book-cover paper (of contrasting colors) cut into strips one inch wide.

MODEL I. GROUND FORM OR FOUNDATION.

Material. — Two strips of red or scarlet.

Three strips of fawn.

Fold red strips across the width through the middle. Fold the fawn color through the middle, tear and fold again and lay these pieces on the desk.

Lay the two folded red strips on the desk; long edge extending from left to right, with upper piece extending about two inches beyond left end of the lower piece, open ends toward the left; have the open ends of the lower piece toward the right. Much future trouble will be avoided if the teacher requires this same arrangement at each lesson.

Now taking one of the short pieces, or weavers, in the right hand, beginning at the top and left end pass the two ends of the weaver *outside* the top and *inside* the lower double strip, drawing the loop ends up close; now with the second weaver work in the same manner from the *bottom* upward; then with another weaver work from the top and so on, until all the strips are used. The teacher may easily judge if all weaving is correct by asking the pupil to hold up the work and at the same time turn it, after each weaver is inserted, as both sides will be alike if correctly woven.

The work is tightened by pulling the opposite ends of the horizontal strips, and every two of the weavers, until the work is flat.

To hold the weaving securely in place, open the free ends and place the paste *inside*, using a thin, flat pasting stick.

GROUND FORM OR FOUNDATION.

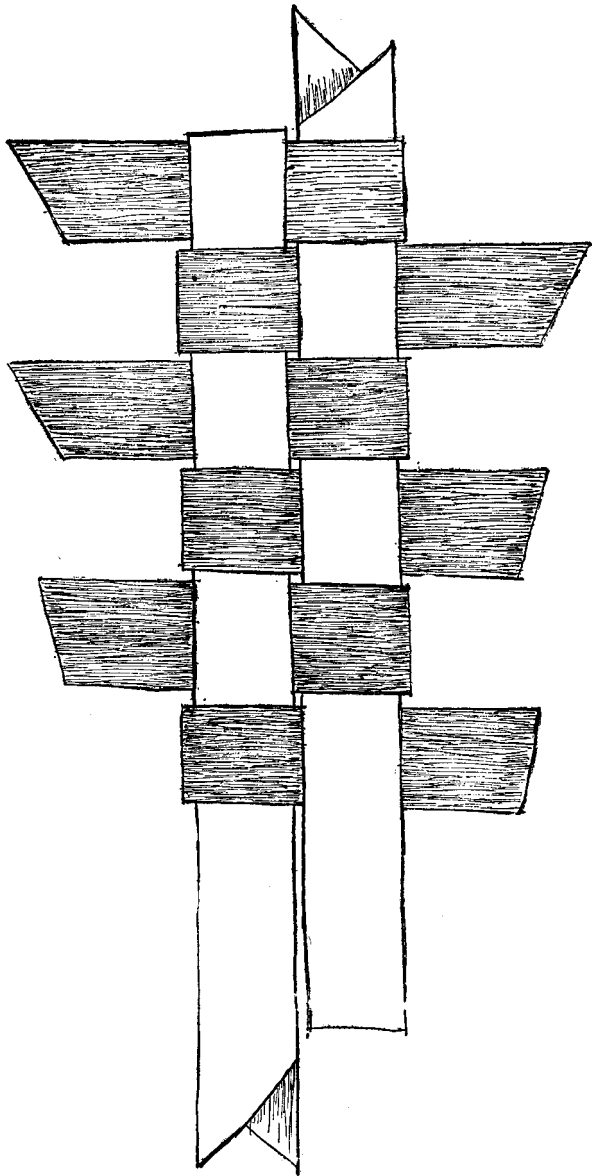

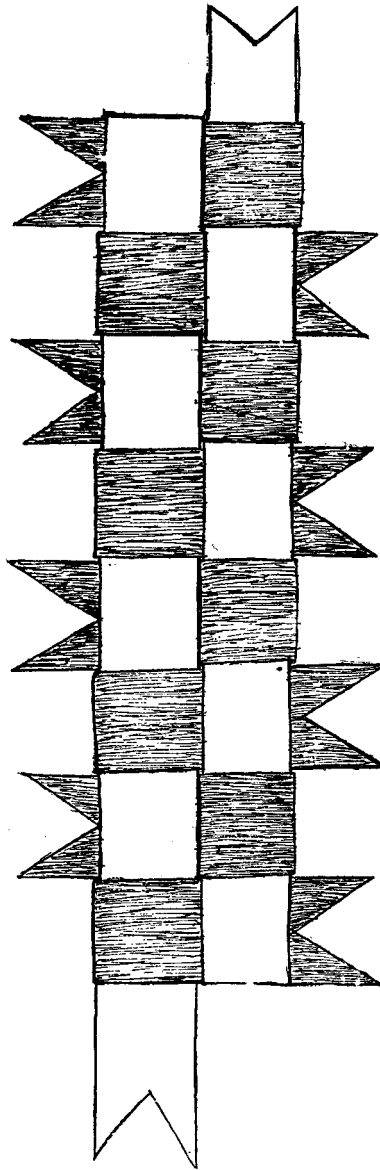

MODEL II. — BOOK MARK.

Material. — Two strips of fawn. Four strips of red.

(Waste of material will be avoided if the two colors are used alternately in the long strips.)

Weave as before, and after pasting, notch the ends of the weavers close to the long strip, leaving the free ends of the long strip about three inches in length. Notch these also.

MODEL III.—NAPKIN RING.

Material. — Two strips of red, four strips of fawn.

Using fawn for weavers, proceed as for bookmark, and after tightening and pasting, cut all weavers *close* to the long strips, and cut the end of the long strips so as to leave $1\frac{1}{2}$ inches extending. Cut corners from these ends, and bringing the two ends of weaving together insert each free end under the second square on the opposite end. *Glue* should be used to hold this in position, placed under the two *outside* squares.

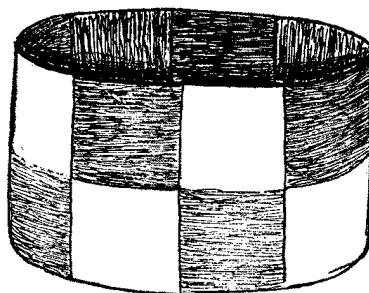

MODEL IV. — MATCH SAFE.

Material. — One strip of red, two strips of fawn.

Use red for horizontal strips, tearing into two and folding. Make four weavers from other strips. Insert the weavers and

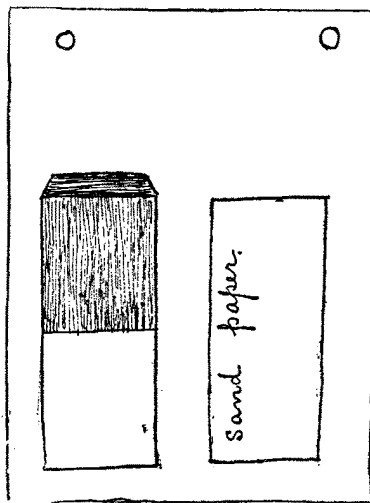

cut close all free ends at the top. Fold at each square, pressing flat to secure sharp edges. Insert the long ends into the opposite side and shape to oblong box. Overlap the free ends on the bottom, cut to length and glue. Cut from cardboard of some harmonious color, a piece 4x3 inches, and glue the box to this near the lower left corner. Cut a piece of No. 1 sandpaper 1 x 2 inches and fasten it to the right of the

box. Perforate the top of cardboard in two places and pass ribbon through for hanging.

MODEL V. — RULER.

Material. — Four strips of scarlet, six strips of fawn.

Glue together each two of the scarlet strips, and use the fawn for weavers. Weave strip twelve inches long, and after

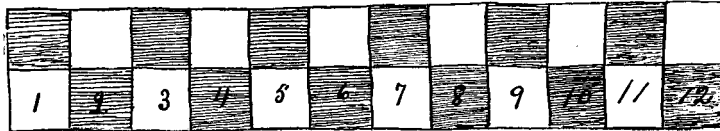

fastening the weaving cut all ends close and mark each square in numbers from one to twelve.

Before allowing the pupil to take this model home, teach its use in measuring.

MODEL VI. — CUBICAL BOX.

Material. — Two strips of fawn, four strips of scarlet.

Using scarlet for weavers, make a strip eight inches long. Glue the ends, and cut close all weavers on the top edge. Fold at every two squares, creasing well, and then join the ends by inserting under opposite squares. Now interlace the other ends of the weavers for bottom of the box, and glue to position.



MODEL VII. — PICTURE FRAME.

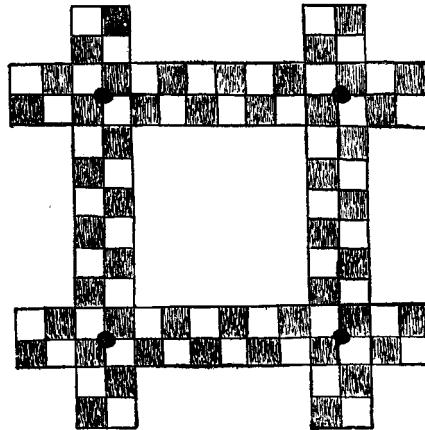

Weave as for ruler, making four strips, each twelve inches in length. Cross ends for frame, and fasten at each corner with *round* head Magill fasteners. Cut a piece of cardboard to size, and glue to the back, leaving an opening at the top. In this cardboard perforate holes, through which pass ribbon for hanging.

MODEL VIII. — ROUND BOX.

Material. — Four strips of fawn.
Seven strips of scarlet.

After gluing the fawn strips so as to make two long ones, use the scarlet for weavers and make a strip fourteen inches long. Fasten the ends of the weavers at the top and cut close. Bring the opposite ends of the woven piece together, and fasten by inserting loose ends under the opposite square. Bend up the remaining ends of weavers for the bottom of the box, and cut two circular pieces of cardboard to fit the bottom; glue one *outside* and one *inside* the box.

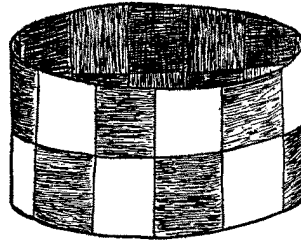

MODEL IX. — OBLONG BOX.

Material. — Six strips of scarlet.
Eleven strips of fawn.

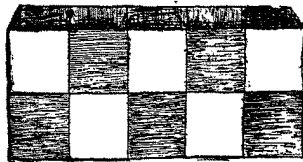

Oblong Box.

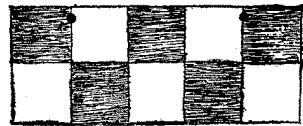

Cover.

Weave band sixteen inches long for box (cover separate). Fasten all weavers on the top edge and cut close. Count two inches from one end and fold for the end of the box; then six inches for one side, and again two for the end. Glue into shape and fit oblong piece of cardboard both inside and outside of box. Weave a strip six inches long for the cover; punch holes one inch in from both ends of the cover and the box and hinge with ribbon.

MODEL X. — BOX WITH HANDLE.

Material. — Sixteen strips of fawn.
Six strips of scarlet.

Using fawn for weavers make a band twenty inches in length. Cut the top ends close and glue to shape, five inches on a side. Fit a double bottom of cardboard and weave the strips for the handle, fastening the handle to the box by using Magill paper fasteners.

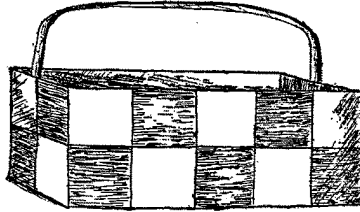

MODEL XI. — CUBICAL BOX WITH COVER WOVEN ON.

Material. — Five strips of scarlet.
Three strips of fawn.



Use scarlet for weavers, but keep two of them full length, tearing the others into halves and folding. Weave first with four short weavers, then insert two long ones. Do not pull these two down close but let them remain far enough above the woven strip to allow the insertion of two fawn-colored strips, and then pull down to position and insert the other two weavers. Fasten into shape and form the bottom

as for Model VI.

This makes a very pretty candy box and the cover may be fastened by tying a band of ribbon round the box.

MODEL XII. — PINCUSHION.

Material. — Two strips of fawn.
Five strips of scarlet.

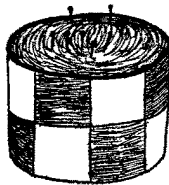

Using scarlet for weavers, make a strip ten inches long. Shape as for circular box and fit double bottom of cardboard. Make a simple form of cushion to fit this box and glue it to position.

CONSTRUCTION IN PAPER.

Series II.

ADVANCED FIRST GRADE.

MODEL I. — ASH CART.

Using one square of paper, 6 in. x 6 in., fold and cut as indicated at Fig. 1. As the wheels are too large to be cut from waste pieces, it will be necessary to give each pupil one-

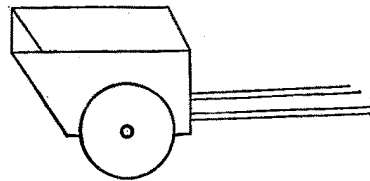

Model I.

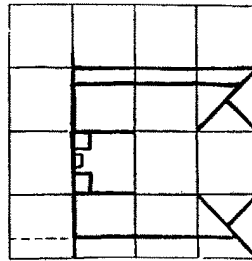
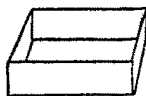

Fig. 1.

half a square of paper from which the wheels may be cut. This piece is not to be folded into squares. Use toothpicks for axle and thills and peas for hubs.



Model II. Tray.

Cut as indicated at Fig. 2. Fold back at dotted lines and bring laps into position, placing them *under* the edge folded down.

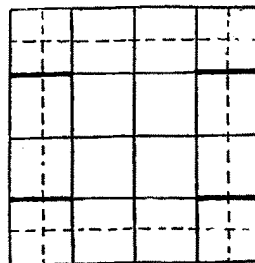

Fig. 2.

MODEL III. — BUTTON BOX.

Cut as indicated at Fig. 3, bring laps into position and paste.

MODEL IV. — EXPRESS WAGON.

Fold and cut square 6 in. x 6 in., as indicated at Fig. 4, using for Fig. 5 one of the pieces cut away, and making the seat from the other piece. The depth of the box is but one-

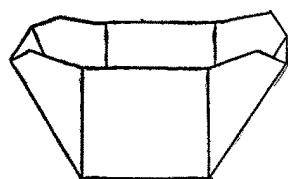

Model III. Button Box.

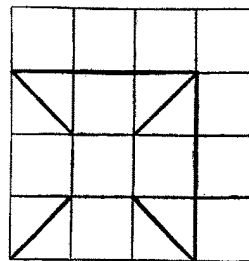
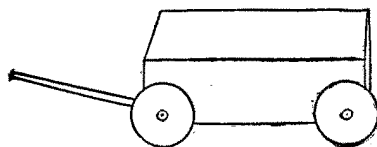

Fig. 3.



Model IV. Express Wagon.

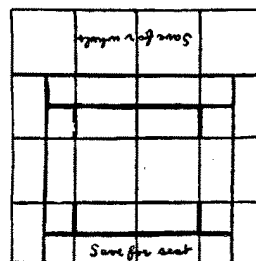
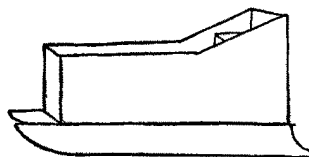

Fig. 4.



Fig. 5.

half the width of the square. Use toothpick for handle and peas for hubs. A cheap quality of collar button may be used for hubs, passing them through the wagon box from the *inside*, and then through the wheel.



MODEL V. — SLEIGH WITH BOX.

Fold and cut the sleigh as indicated at Fig. 6, and the

box at Fig. 7. Pass the end of a piece of cord eight inches long through the holes, and fasten.

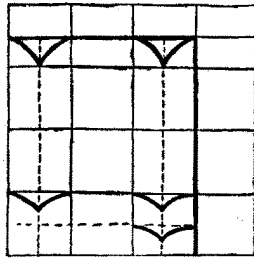

Fig. 6.

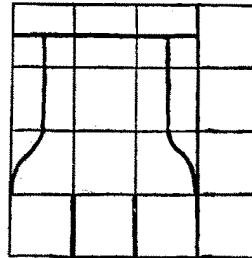

Fig. 7.

MODEL VI. — EGG BOX.

Cut box as indicated at Fig. 8, and cover at Fig. 9, using one-inch semi-circular tablets for tracing thumb places.

Use for partitions pieces cut away from Figs. 6 and 7, and cut as indicated at Fig. 10.

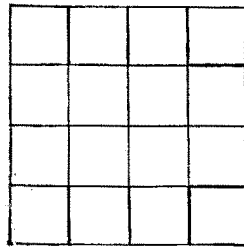

Fig. 8.

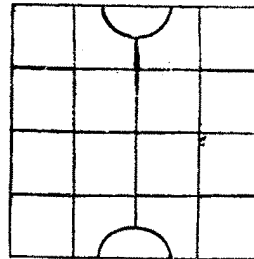
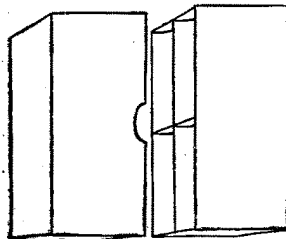

Fig. 9.



Model VI. Egg Box.

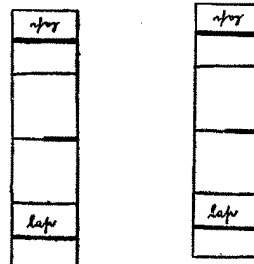
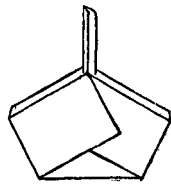

Fig. 10.

MODEL VII. — SHOPPING BAG.

Fold and cut as indicated at Fig. 11, saving for handle the piece cut away, and folding it in the middle—lengthwise. Cut and use one piece for handle, folding it lengthwise and



Model VII.

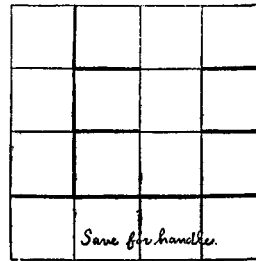
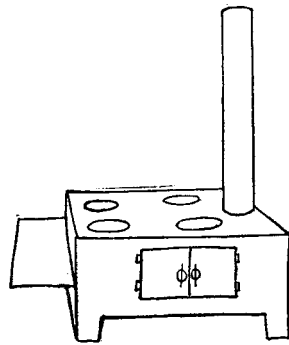

Fig. 11.

using double. In pasting bring the *inside* corners of *outside* squares together and place the middle square inside these two, with the ends of the handle between.

MODEL VIII. — STOVE.

Use for this model three squares of *black* paper 6 x 6 inches.



Model VIII. Stove.

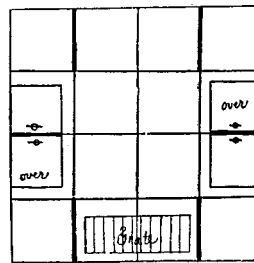

Fig. 12.

Fold and cut as indicated at Fig. 12 for body of the stove, making lines for *grate* with a red lead pencil. Indicate, with black pencil, the hinges and knobs on oven doors.

Cut and fold hearth as indicated at Fig. 13, showing hinges and knobs on doors. Bring Fig. 12 into shape and

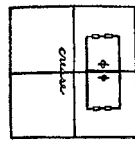

Fig. 13.

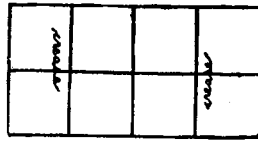

Fig. 14.

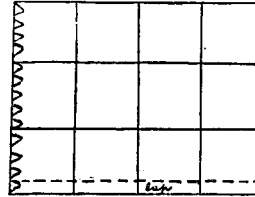
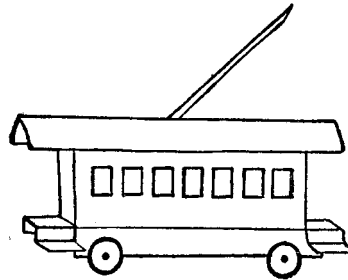

Fig. 15.

paste. Use Fig. 14 for the bottom of the stove, fastening it onto the *inside* of front and back of stove, so as not to interfere with the use of the oven. Place the hearth in position and fasten, then open front doors. Cut and fold the pipe as indicated at Fig. 15 and glue to the stove.



Model IX.

MODEL IX. — TROLLEY CAR.

Cut as indicated at Fig. 16, cutting *out* for windows, or the windows may be indicated by pencil lines and not cut out. Cut the bottom of the car as indicated at Fig. 17. Use tooth-picks for axle and peas for hubs, making wheels from the piece cut away from

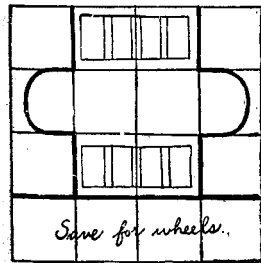

Fig. 16.

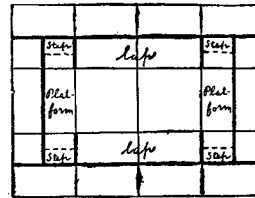

Fig. 17.

Fig. 16, and the pole from the other waste piece, fastening it to the car as indicated in the drawing.

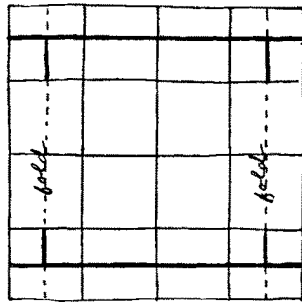

Fig. 18.

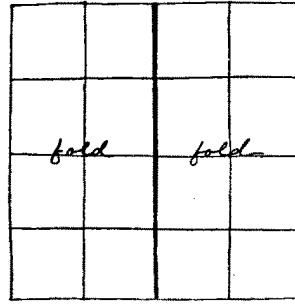

Fig. 20.

MODEL X. — BED.



Fig. 19.

Two squares are needed for this model, using for the legs the pieces cut away from previous models.

Cut and fold the body of the bed as indicated at Fig. 18, making it three squares in length and two in width. Fold the legs as indicated at Fig. 19 and glue body and legs to position.

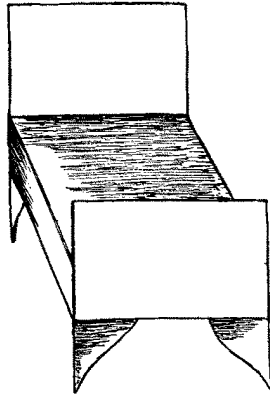

Model X. Bed.

Cut Fig. 20 into halves, as indicated by full line, making the headboard four squares in length (before folding), and the footboard three squares. Now fold both pieces across the width and use these doubled pieces for the head and footboard and glue to place. Both these pieces may be cut across the top, to any desired shape.

MODEL XI. — WASHSTAND.

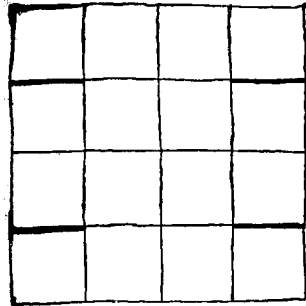

Fig. 21.

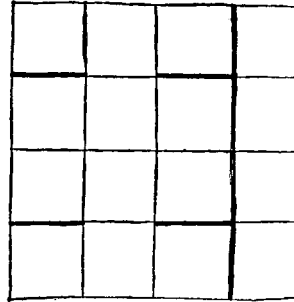

Fig. 22.



Fig. 23.

Three squares are needed for this model.

For the body, fold and cut as indicated at Fig. 21. Bring laps into position and glue to place.

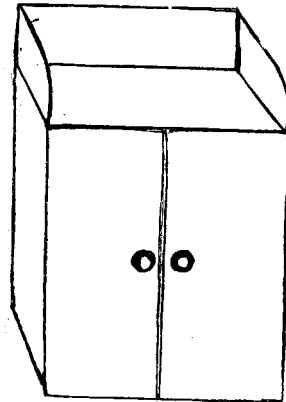

Model XI. Washstand.

Fold and cut two models as indicated at Fig. 22. Glue into shape, and stand the two oblong boxes thus formed *on end* inside the square box formed from Fig. 21. Locate the points for the knobs and here place two round-head paper fasteners. Shoe buttons may be used instead. Shape the back as indicated at Fig. 23 and glue to the body of the washstand.

MODEL XII. — DRESSING TABLE.

Four squares are needed for this model. Fold and cut the body as indicated at Fig. 21, and the two drawers at Fig. 22.

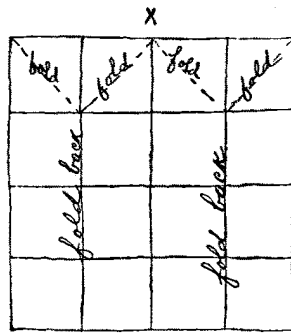
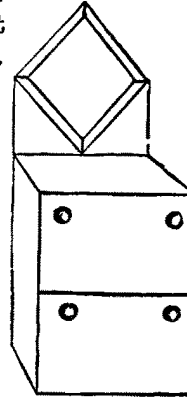

Fig. 24.

Glue to shape and place the oblong boxes horizontally inside the square box, using paper fasteners for knobs.

For the back, fold as indicated at



Model XII. Dressing Table.

Fig. 24, and then turn one thickness down toward the front from point X. This will form a square on its diagonal. Cut away the middle portion of this square leaving about one-fourth of an inch around the edge. This forms the width of the frame. Inside this insert a square of tin foil to form the *mirror*.

MODEL XIII. — GO CART.

But one square is used for this. Fold and cut as indicated in Fig. 25.

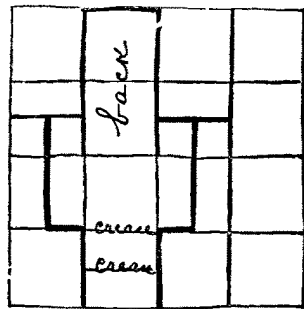
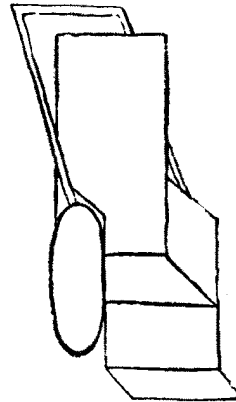

Fig. 25.



Model XIII. Go Cart.

Turn up the squares forming the back and glue the laps into position. Crease the step into shape and add toothpick for axle, using peas for hubs. Save the four squares, cut away from one side, for the handle. Cut this through the middle, lengthwise. Fold each piece through the middle, lengthwise, join the two pieces, bend for the handle, and glue into position. Use the squares cut from the corners in making the wheels.

MODEL XIV. — CRADLE.

Two squares are needed to form the body of this model. Fold and cut two forms as indicated at Fig. 26. Glue to

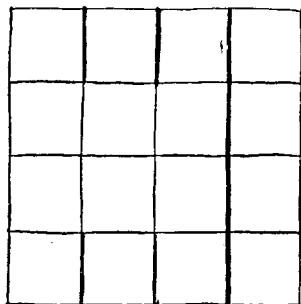
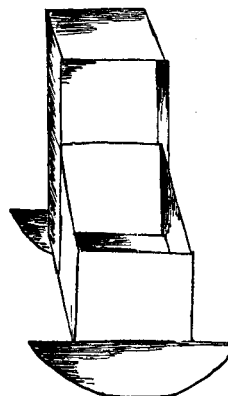

Fig. 26.



Model XIV. Cradle.

shape and stand one, *on end*, inside the other one. This will form the hood. Variety may be given to the shape of the body of this model. For the rockers divide one six-inch square into four smaller ones, and on one of these trace a circle, using a two-inch tablet. Cut to line, fold through the middle, and cut. It will be necessary to cut away that portion of the rocker touching the floor in order to have the cradle stand upright.

CONSTRUCTION BY MEASUREMENT.

ADVANCED FIRST.

Second School Year.

After having worked out many lessons in paper construction by folding, the pupil is led to pattern-making with the use of the ruler, and here the *lap* is introduced. As yet, however, we keep this troublesome feature of construction as large as possible, since it is in the execution of fine details that the child becomes discouraged. These models have been worked out by pupils in the advanced first year. By previous training they have become familiar with the use of the ruler and are able to draw lines to given lengths and lay out simple surface coverings. The forms, being made from drawing paper, are easily folded on the line, no *scoring* being necessary, as is the case when using bristol board.

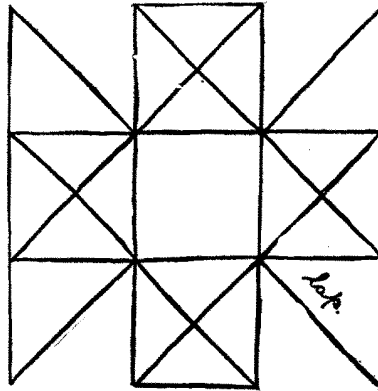

Fig. 1.

All patterns are based on the square, and are purposely made very simple in order to introduce decoration, using water colors or colored lead pencils. The squares vary in size from $1\frac{1}{2}$ to 2 inches. The rulers are marked in one inch and half-inch spaces.

In Fig. 1 the squares are three inches across. The rulers are placed on the edge of the paper and the spaces marked here, with black pencil, as a finer dot may be made with the black than with a colored one. The cross lines are drawn with the colored pencil and the nine squares needed are

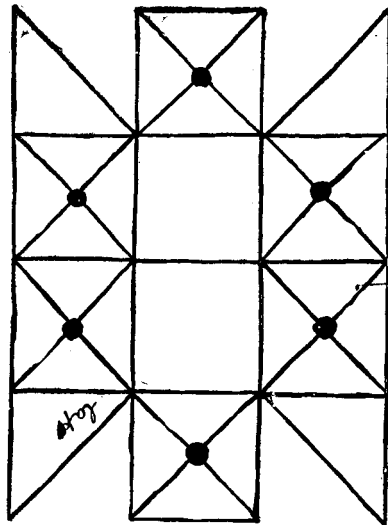

Fig. 2.

now cut away. Cut away the triangles as indicated in the drawing and decorate with diagonal lines.

In Fig. 2 the squares are two inches in size. Proceed as in Fig. 1 and decorate as in the drawing.

In Fig. 3 the size of the square is one and one-half inches. Proceed as in Fig. 1. For decoration add the diagonal lines and at the points of intersection cross with a line extending one-half inch in each direction.

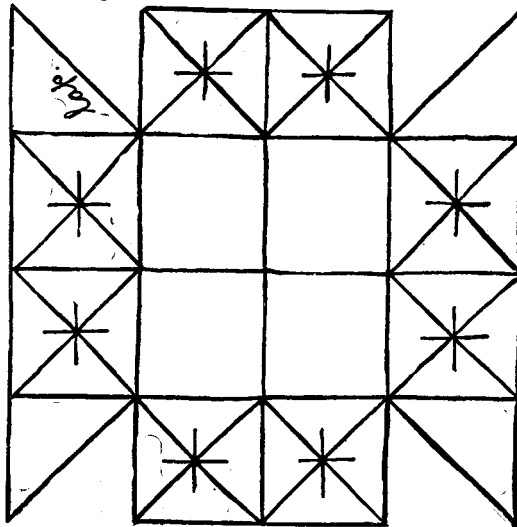

Fig. 3.

Fig. 4 is, when completed, like Fig. 1, but differs in manner of development. Cut in on the heavy lines. Decorate as indicated in the drawing.

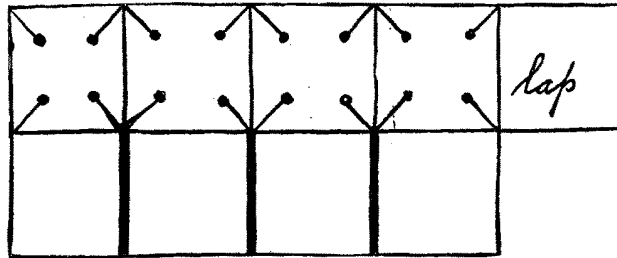

Fig. 4.

Fig. 5. Size of squares, 2 inches by 2 inches. Cut in on heavy lines. Suggestion for decoration is given in the drawing.

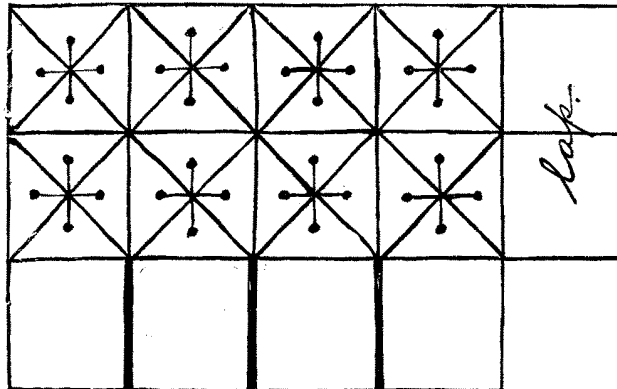

Fig. 5.

Fig. 6. Size of squares, 3 inches by 3 inches. Cut in on heavy lines for the bottom, and the cover. Decorate as suggested in the drawing.

Fig. 7. Size of squares, 2 inches by 2 inches. Cut in on heavy lines to form the cover and the bottom. Suggestion for decoration given in the drawing.

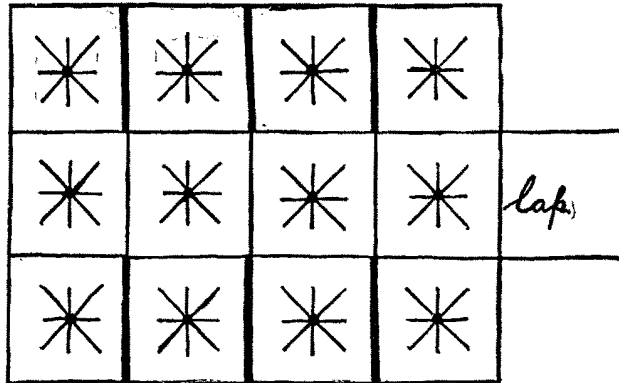

Fig. 6.

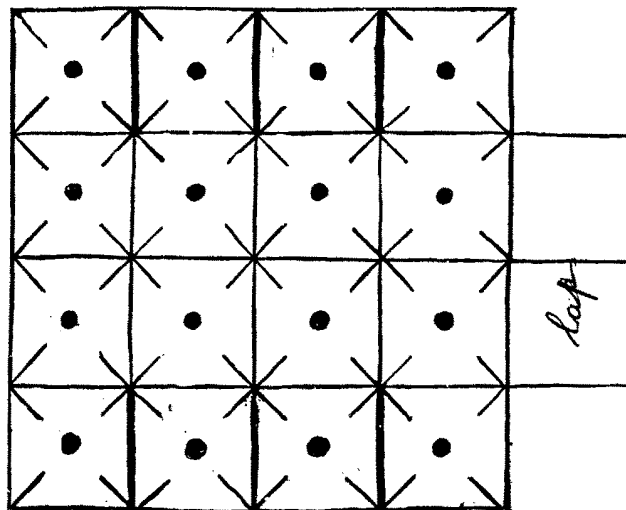

Fig. 7.

When these models (VI. and VII.) are used for candy boxes, they are made more attractive by the addition of a ribbon band.

FREE WEAVING.

Series II.

ADVANCED FIRST GRADE.

Second School Year.

Having previously worked out Series I., the pupils have acquired a deftness of hand which will enable them to take up these more difficult models. Pupils, to whom the work is new, often enter at the beginning of a school year, and it is always well to review the "ground forms" or foundation work given in Series I. Review also the book marker.

In this series use book-cover paper in two contrasting colors, or in tint and shade of the same color. Have the paper cut into strips one-half inch wide.

MODEL I. — PICTURE FRAME.

This frame is but two strips in width, but at the end of the series it may again be introduced four or six strips wide.

Fold four strips of each color through the middle across the width. Lay the light strips horizontally across the desk, with the open and closed ends alternating at the sides. With the dark strips proceed to weave under and over, leaving all ends long, *i. e.*, do not *draw up* any ends. This will form a square with long ends on all sides as in Detail I. Now separate these squares so that four will come on each corner with a loose band between. The distance between each set of squares should be but little over three inches. The ends may now be drawn so that the closed end is *nearly* to the outside edge of the frame.

It will now be observed that the light and dark strips are on opposite sides of the frame. Take twelve pieces of each color and fold crosswise through the middle. Weave these in and out the space between the corner squares, placing the dark on the side with the light strips and *vice versa*. Now tighten

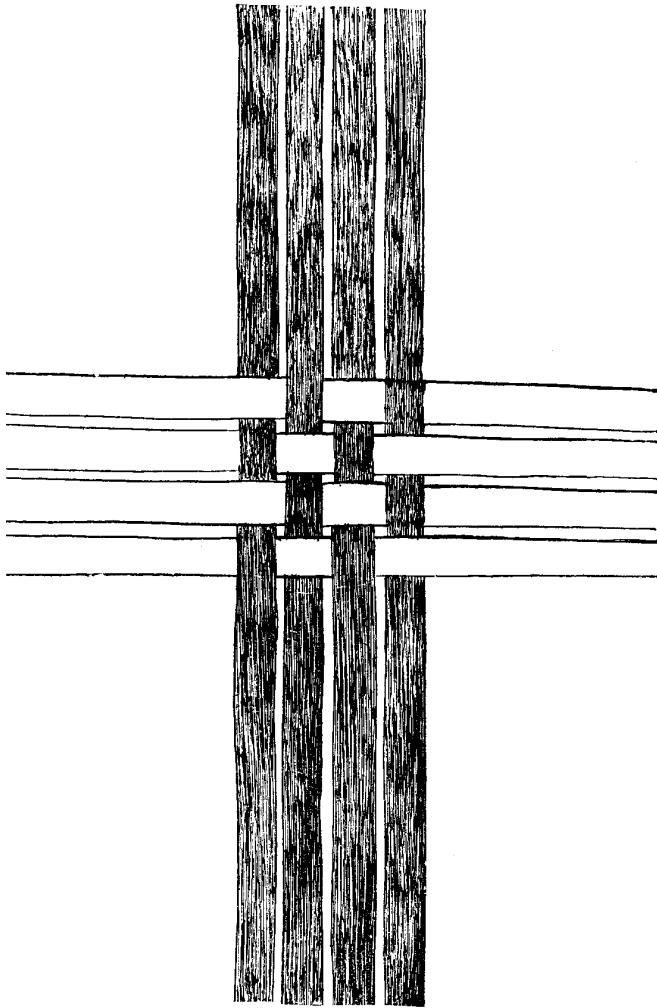

Detail I. Picture Frame.

all the strips, being careful to not pull the opening for the picture *out of square*. Glue cardboard to the back of this frame, leaving an opening at the top into which the picture is to be slipped. An easel back may be provided, or a cord used for hanging. The back may be so glued on as to permit the hanging of the frame with the square on its diagonal.

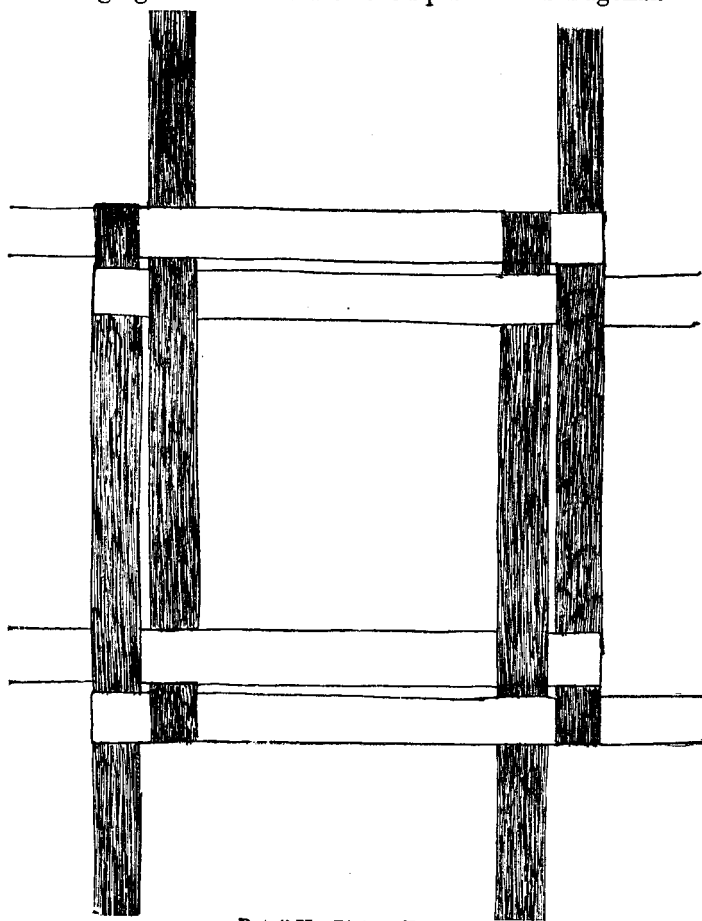

Detail II. Picture Frame.

Oblong frames may be made in the same manner by inserting more strips on the sides than across the top.

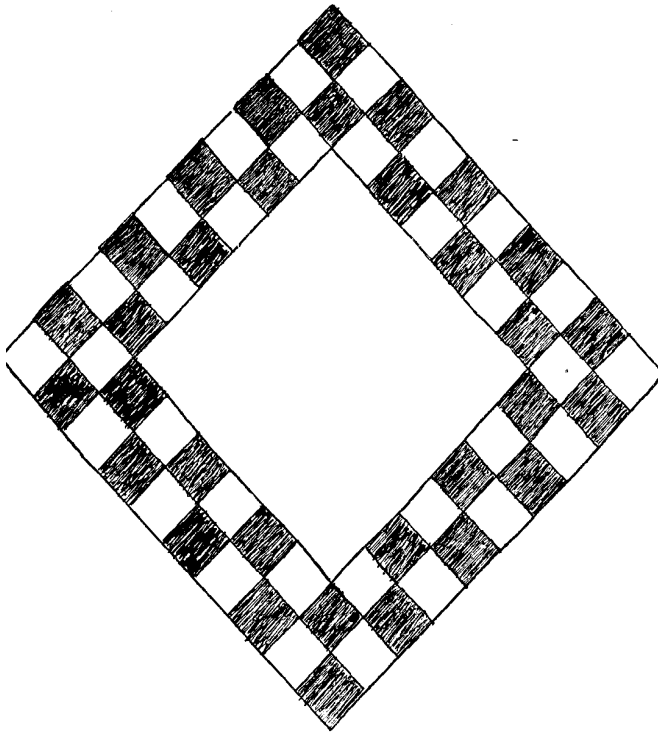

Model I. Picture Frame.

SQUARE AND OBLONG MATS.

Mats of different sizes and shapes may be woven and utilized in various ways. Either by using them for lamp-mats, etc., or for mounts for calendars, thermometers, blotters, etc. For the square mats, have all paper strips of the same length.

Difficulty will at first be experienced in having the pupils keep the strips from slipping out of position, while the work

is being started, but this is soon overcome, and as so little preparation of materials is required, this form of manual training may be used for *busy work*.

CORNUCOPIA.

Weave a mat ten squares each way. Perforate two adjacent edges. Bring the opposite corners together, and lace with narrow ribbon, finishing with a bow.

Double cornucopias may be formed by weaving an oblong mat, twenty squares by ten, and bringing both lower corners up to the middle of the top edge; fasten in position.

BLOTTER BACK.

Weave an oblong mat ten squares long and four or six wide. Cut an oblong piece of blotting paper, in size one-half inch shorter and one-half inch narrower than the woven mat, to which it should be glued.

CALENDAR BACK.

Weave a square mat six squares by six, and fasten the calendar to this, choosing such size as will leave a margin of one square all around the calendar. Oblong mats may be woven to fit oblong calendar pads.

THERMOMETER BACK.

Weave an oblong mat four squares wide and six squares long, using paper strips one-half inch wide. Fasten the thermometer to this back by sewing through the holes, and, if desired, a bow may be tied here.

COVER FOR NEEDLE BOOK.

Weave an oblong mat, making it eight one-half inch strips, or four one-inch strips wide, and twelve one-half inch, or six one-inch strips in length. Fold through the middle across the width. Cut the leaves from white flannel and have the edges notched. Open the cover, lay the leaves in position and perforate in three places. Pass a narrow ribbon through these holes, bring both ends to the outside, and here form a bow.

COVER FOR MEMORANDUM BOOK.

Weave an oblong mat, making it twelve squares in length and eight in width.

Fold this through the middle, across the width to form the cover.

Cut, for the leaves, oblong pieces of white paper, in width one-half inch narrower and in length one-half inch shorter than the oblong forming the cover. Fold these and place inside the cover. Now perforate this book in two places, pass a narrow ribbon through these perforations, and tie. Attach a lead pencil to one end of the ribbon used for binding the back. All short pieces of lead pencils may be collected from time to time and saved for this purpose.

BOXES.

Many shapes and sizes may be given to these woven boxes, and *firmness*, also, if a heavy quality of paper is used. The shapes are formed as in the models for more elementary work, in previous pages. The covers may be woven on, or else made separate and the loose ends fastened into the back edge of the box. When the box is large, it will be found much easier to construct it, if both the bottom and the cover are made separate. If the bottom is woven separately, it is fastened into place by passing the loose ends of the bottom edge of the piece forming the *sides* of the box into the edges of the mat forming the bottom.

Handkerchief and glove boxes may be made very durable by fitting an inner box of heavy cardboard, or oak tag, and gluing the woven outside box to this one. The inner box may be painted, so as to harmonize with the colors of the outside.

CONSTRUCTION IN CARDBOARD.

Second Year.

Third School Year.

The following models may be constructed in cardboard, oak tag, or Essex bristol. The latter comes in a variety of artistic and pleasing colors, and the light weight is quite as inexpensive and much more attractive than *oak tag*. There is no saving in expense, but a great waste of the teacher's time, if she attempts to cut the material for each lesson, to the size designated in the following directions.

The material is usually ordered for a year's work, and of one size throughout. In all these models a saving will be effected if, placing the ruler along the top and bottom edge of the paper, the spaces for the vertical lines are dictated, these lines drawn, and the cardboard be now cut to the exact width required.

Now locate on the edges of this piece the spaces for the horizontal lines, and after drawing these lines, cut the paper to the exact length.

The teacher having placed the drawing on the board as she dictated to the class, now indicates the parts to be *cut away*, by using colored crayon; thus making the details less confusing. The pieces cut away will often be large enough to use for another model.

Le Page's glue is used for joining all models constructed of any material heavier than paper.

As the pupils come to see *how* folding boxes may be constructed they become intensely interested, and specimens of all shapes and sizes are brought in, with the request, "May we make this?"

A quantity of oak tag may be kept where the pupils have free access to it, and scissors and glue conveniently near. For "busy work" nothing can be better than to encourage

the developing of any box brought in, always insisting that the drawing be made by measurement, and not traced. For the pupils who cannot work unaided, the teacher should mount, on a large sheet of heavy cardboard, working drawings of different models, and also fasten to this, by a piece of cord, two models of each drawing; glue one to shape, and leave the other *flat*. Hang these sufficiently low, so the pupils can handle the models, and study the drawing.

MODEL I. — BUTTON BOX.

Material.—Essex bristol, six inches square. Draw the diagonal lines. Place a dot on each line, one inch from the point of intersection. Draw lines connecting these dots. The

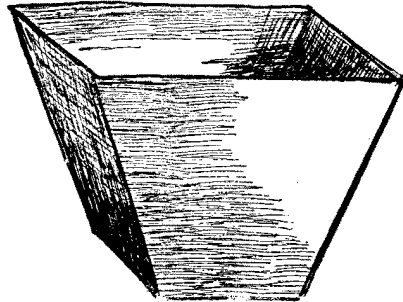

Model I. Button Box.

square thus formed becomes the bottom of the box. To form the sides of the box, find the middle of the upper edge; from this point measure one and one-half inches to the right and left, and here place a dot, marking these points A and B, as in Fig. 1. Draw lines

from these points to the corresponding corners of the inner square. Repeat this drawing on the other three sides. To form the laps, measure on the upper edge, three-eighths of an inch from the points marked A and B, and from the corresponding corners of the inner square, measure three-quarters of an inch on the *diagonal* lines. Connect these points with opposite ones. As laps are needed on two sides only, lines similar to these are drawn on the *opposite* side of the box.

Now cut to line, and cut off the upper corners of the *lap*. This may be done free hand, or by measuring down three-

eighths of an inch, and drawing lines to A and B. Cut to these lines. Before folding, it will be necessary to score all lines forming edges. This is done by using the sharp point of the scissors, a knife or a pin.

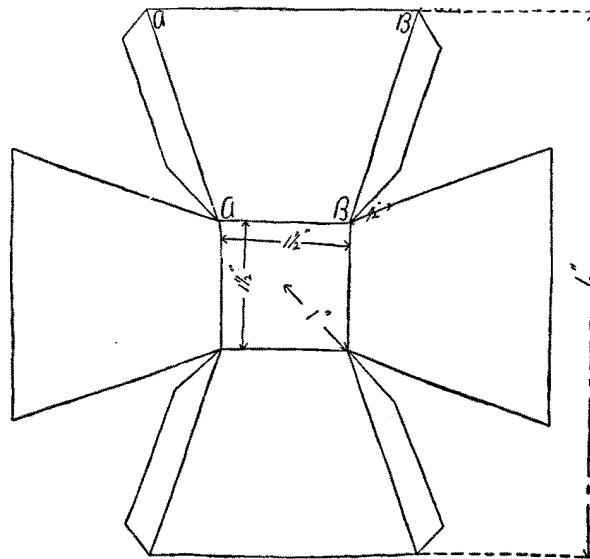

Fig. 1.

MODEL II.—TENT.

Material.—Oak tag; size, 12 in. x 12 in.

Place the tag board with two edges parallel to the edge of the desk.

Placing the ruler along the upper edge of the paper, measure to the right one and one-quarter inches, and here place a dot, marking this point A, as in Fig. 2. Repeat this at the lower edge, and draw lines connecting these two dots. From each of these dots measure to the right four inches, and again draw connecting lines. Locate point B. From the ends of this line, measure two and one-half inches to the right, draw

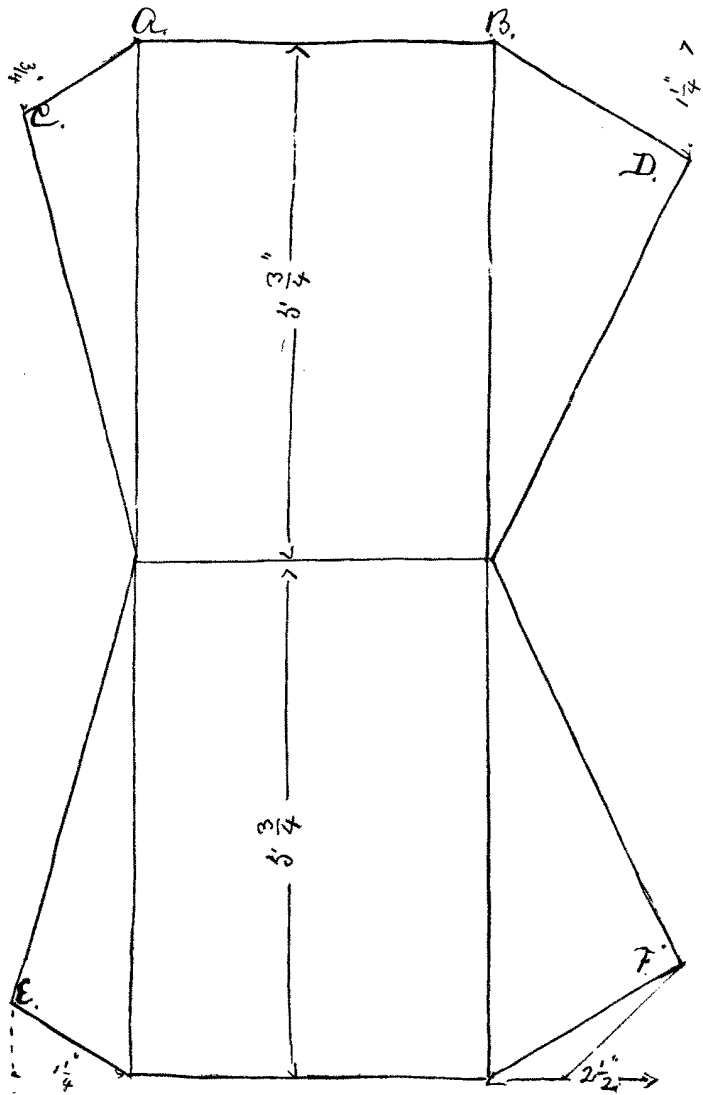
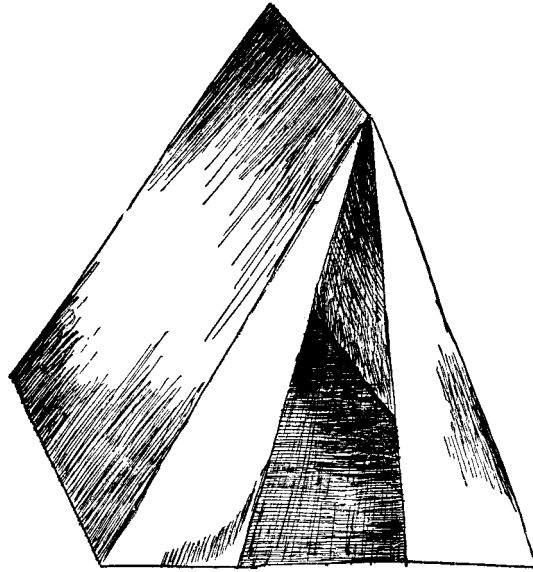

Fig. 2.



Model II. Tent.

connecting line, and cut to this line. Lay aside the piece cut away and place the drawing on the desk in the same position as before. From the upper left corner, measure down three-fourths of an inch, place a dot and draw a line from this dot to A. From the lower left corner measure *up* three-fourths of an inch and draw a line from this point down to the end of the line opposite point A. Cut to these lines. From the upper right corner, measure down one and one-fourth inches, place a dot, and draw a line from this dot to point B. From the lower right corner, measure up one and one-fourth inches, place a dot, and draw a line to end of the line opposite point B. Cut to these lines. Locate points C, D, E and F. From points A and B, measure down five and three-fourths inches and draw a line across. Now draw a line from the ends of this line to points C, D, E and F. Cut to these lines and score all

remaining lines. Fold for the body of the tent. For the floor of the tent use the piece cut away, and place it with its long edges parallel with the front edge of the desk. From the upper left corner, measure one-half inch to the right, and place a dot. Repeat this at the lower left corner and draw a line across.

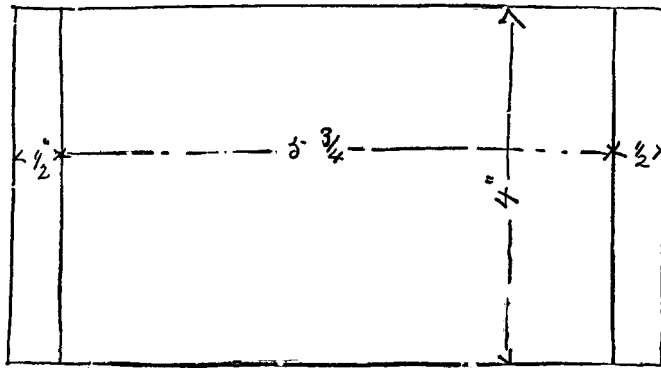

Fig. 3.

From the ends of this line, measure to the right five and three-fourths inches, and draw a line across. See Fig. 3. From the ends of this line, locate points one-half inch to the right and draw a line across. Cut to this line. Placing the drawing on the desk in the same position as before, measure down four inches from the upper right and upper left corners, place dots and draw a line across. Cut to this line. Score all remaining lines, fold, and glue into position.

MODEL III. COIN BAG.

Material. — Oak tag; size, 7 in. x 7 in.

Place the paper with its short edges parallel with the front edge of the desk. From the upper and lower left corners measure to the right one inch, place dots and draw a line across. See Fig. 4. From the ends of this line measure two inches to the right and draw a line across. Measure one and one-half inches to the right from the ends of this line, draw a line

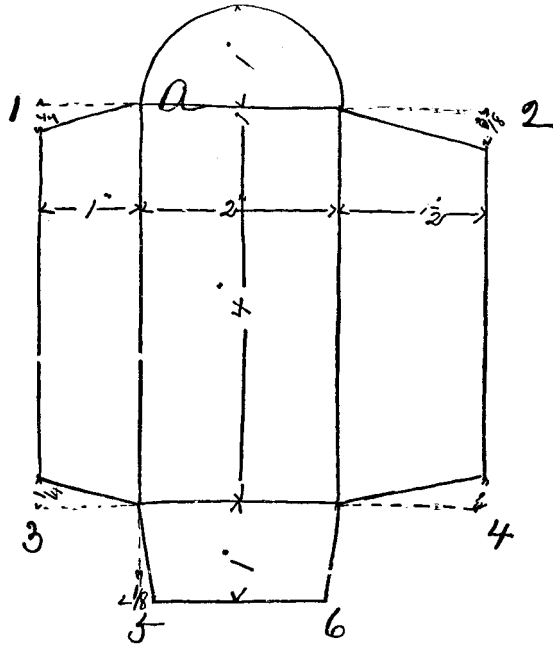
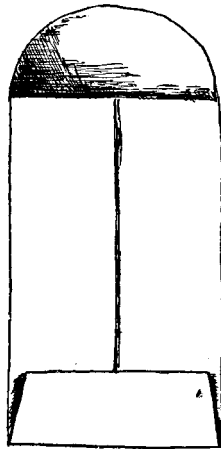

Fig. 4.



Model III. Coin Bag.

across and cut to this line. From the two upper corners measure down one and one-half inches, place dots and draw a line across. Cut away the two corner *oblongs* thus formed, lay a two-inch semi-circular tablet with its straight edge coinciding with line A, and trace around the curved edge, using a sharp lead pencil. Cut to this curved line. From the two upper outside corners measure down four inches and draw a line across. From the ends of this line measure down one inch, draw a line across and cut to this line. Cut away

the square formed in lower left corner and the oblong formed in lower right. Locate points 1, 2, 3, 4, 5, 6. From point 1 measure down one-fourth inch, draw a line to the inner upper corner and cut to this line. From points 3 and 4 measure up one-fourth inch, draw lines down to the inner corner and cut to these lines. From point 2 measure down three-eighths of an inch, draw a line up to the inner corner and cut to this line. Measure one-eighth of an inch to the right of point 5 and to the left of point 6. Draw lines to the upper corners, cut to these lines, score all remaining lines, fold and glue into shape.

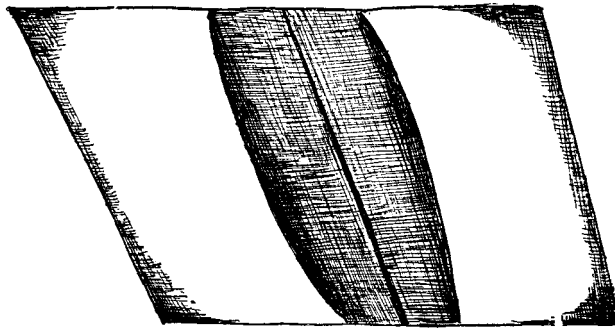

Model IV. Card Case.

MODEL IV. CARD CASE.

Material. — Essex bristol; size, 11 in. x 8 in.

Place the paper with its long edges parallel with the edge of the desk. Measure down one inch from the upper right and upper left corners, and here place dots on the edge of the paper. Draw a line connecting these dots. See Fig. 5. From both ends of this line, measure down five inches, place dots, and draw connecting line. Measure down one inch from both ends of this line, place dots, draw connecting line, and cut to this line.

From the upper and lower left corners, measure to the right two inches, place dots, and draw connecting line. Three inches to the right of this line, draw another line, and again

a second line, at the same distance, three inches. Locate points two inches to the right of the last line, draw connecting line,

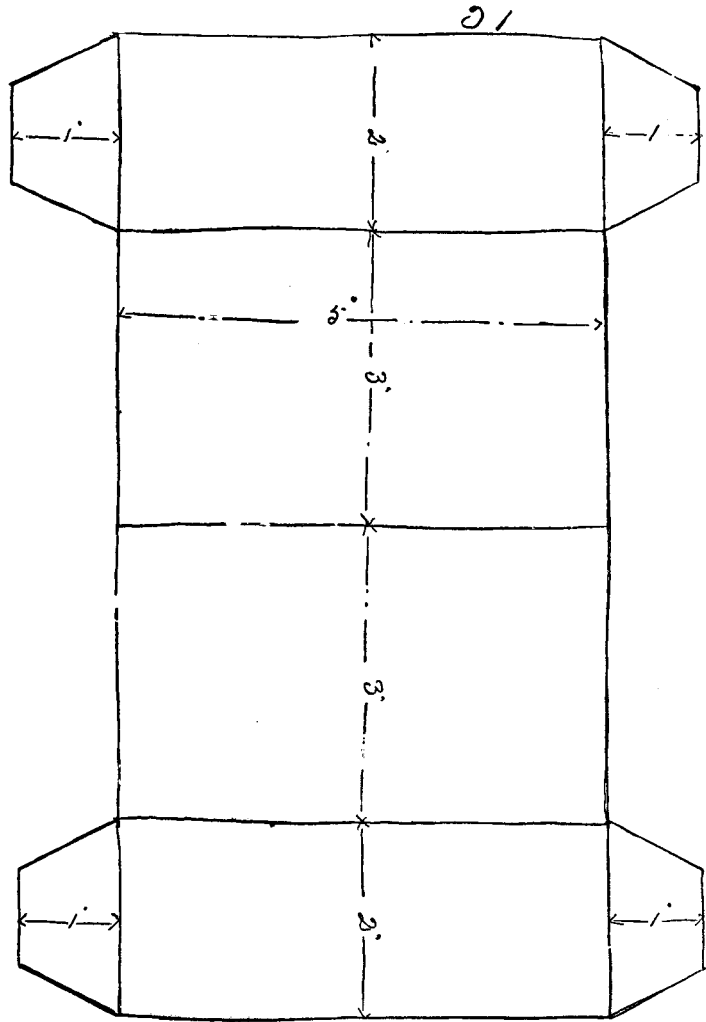

Fig. 5.

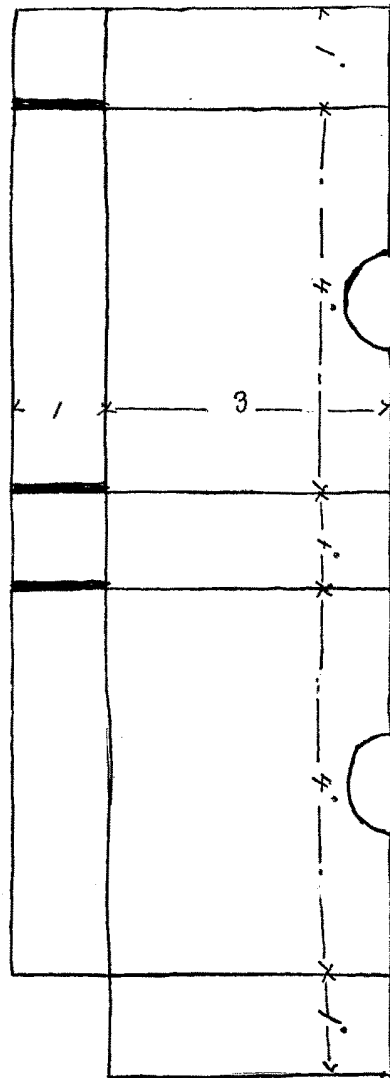

Fig. 6

and cut to this line. Now cut away, from both sides, the oblongs three inches by one inch. There are now four projecting pieces, size, two inches by one inch.

Measure in one-half inch on each outside corner of all four, and draw lines to the other corners, as shown in the drawing. Cut to these lines, score all remaining lines, fold, and glue to position.

MODEL V.—LETTER CASE.

Material.—Essex bristol; size, 12 in. x 5 in. Place the paper with its long edge parallel with the edge of the desk. From the upper left and upper right corner measure down three inches and draw a line across. From both ends of this line measure down one inch, draw a line across, and cut to this line. From the upper

and lower left corners measure one inch to the right and draw a line across. See Fig. 6. Four inches to the right of this line draw another one. Again, one inch to the right of this one, and now four inches to the right of this last line. Again measure one inch to the right, draw a line, and cut to this line. From the lower edge cut up as indicated by the heavy lines in the drawing.

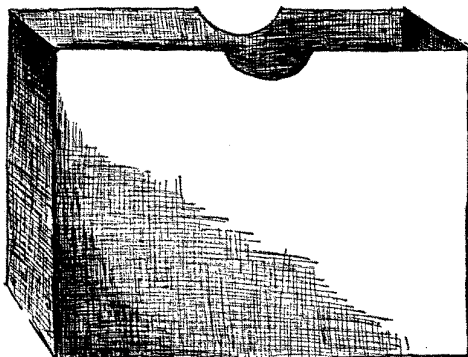

Model V. Letter Case.

Find the middle of the upper edge of each four-inch space, and place a dot. Place a one-inch semi-circular tablet with the middle of its straight edge at this dot. Using a sharp pointed pencil, trace around this tablet. Cut to this circular line. Score all remaining lines, fold and glue to position.

MODEL VI. — CARD HOLDER.

Material. — Essex bristol; size, 10 in. x 6 in. Place the paper with its short edge parallel with the edge of the desk. From the upper and lower left corners, measure to the right one and one-quarter inches, and draw a line across. See Fig. 7. Three inches to the right of this line draw another one, and again one and one-fourth inches to the right of this last line, draw another one, and cut to this line. From the upper cor-

ners measure down three inches and draw a *light* line across. Place another line two and three-fourths inches below this line, and again three inches lower down draw another one. Cut to this last line. Cut the oblong spaces away from the upper corners. Measure down one and one-half inches from the upper corners of the projecting piece, and here place

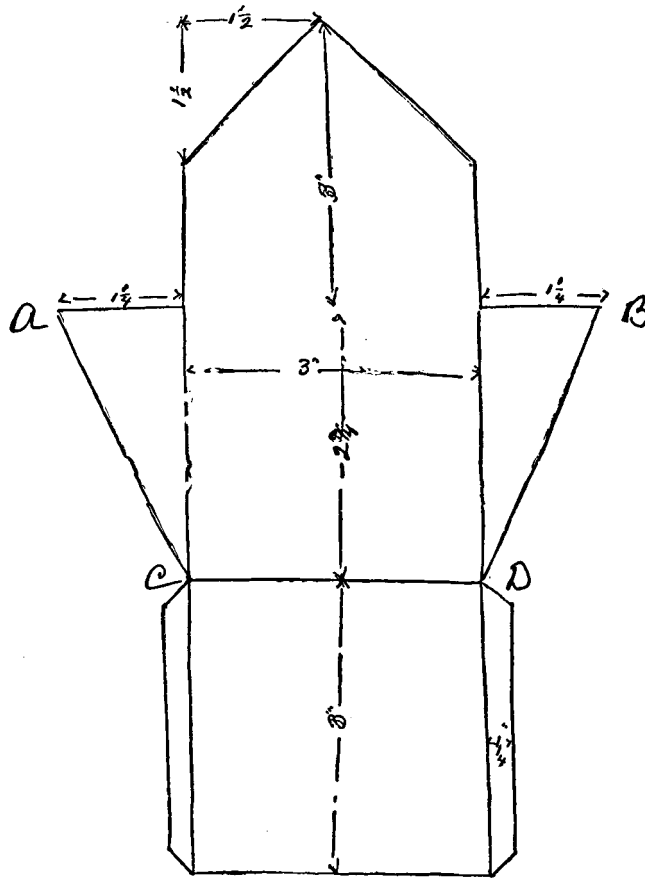
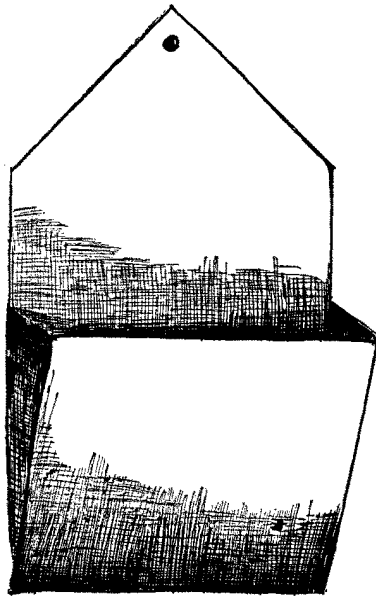

Fig. 7.



Model VI. Card Holder.

From the upper and lower left corners, measure to the right two and one-half inches, and draw a line. See Fig. 8. Five inches to the right of this line draw another; measure again two inches and one-half to the right, draw a line and cut to it.

From the upper corners, measure down four inches, and draw a line across.

Two inches and one-half below this draw another line, and again, two and one-half inches, another one. Cut to this line. Measure, for one-quarter inch lap, to the left of line C-E, and to the right of line D-F. Cut to these lines, and shape the lap as indicated on drawing.

From the upper corners, measure down one and one-half inches, and place dots on the edges of the paper. From these

dots. Find the middle of its upper edge, and from here draw lines to the dots just located, and cut to these lines. From the outside corners A and B, draw lines to C and D. Cut to these lines. Score all remaining lines, excepting the *light* one crossing the back of the case. Perforate the hole for hanging, fold and glue.

MODEL VII. — PHOTO-
GRAPH HOLDER.

Material.— Bristol board; size, 11 in. x 10 in.

Lay the paper with its long edges parallel with the edge of the desk.

dots, draw lines to points A and B, and cut to these lines. Find the middle of the upper edge (the five-inch space), and here form the semi-circular opening. Repeat this at the lower edge. Score all remaining lines, fold, and glue to position.

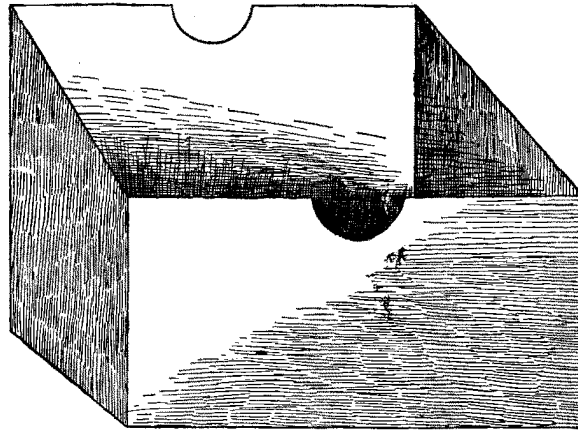

Model VII. Photograph Holder.

MODEL VIII. WALL LETTER CASE.

Material.—Essex bristol; size, 12 in. x 7 in.

Place the paper with its long edge parallel with the edge of the desk. Measure in on top and bottom edge, four inches, and draw a line across. See Fig. 9. Form another space of one and one-half inches, another of four inches, and still another of one and one-half inches in width. One-quarter inch to the right of this last line, draw another one, and cut to this line. From the upper corners, measure down one and one-half inches on the edge of the paper, and draw a line across. Three inches below this line draw another one, and again, one and one-half inches, another one. Cut to this line.

Cut away the oblongs in the upper corner, leaving the projecting piece as indicated. Find the middle of this upper

edge, and draw lines from this point to a point one-half inch below each corner. Cut to these lines.

From points A and B, measure down one-quarter inch, draw line and cut for laps. Shape as indicated. Score all remaining lines, *except* the line across the back. Fold to position and glue. Perforate the hole for hanging.

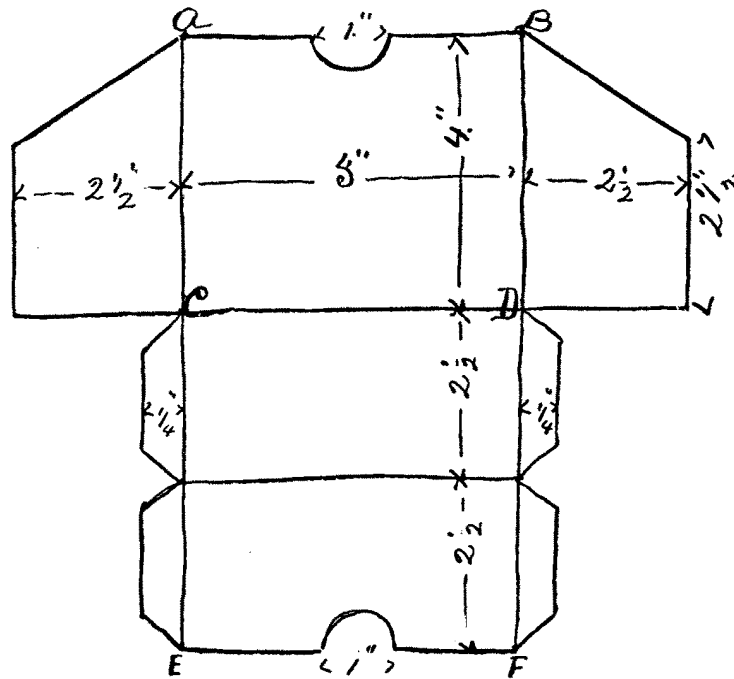

Fig. 8.

MODEL IX. — EGG BOX.

Material.—Essex bristol; two pieces, size, 11 in. x 9 in.

Lay the paper with its long edge parallel with the edge of the desk. From the upper corners measure down two inches and draw a line across. Place another line four inches below

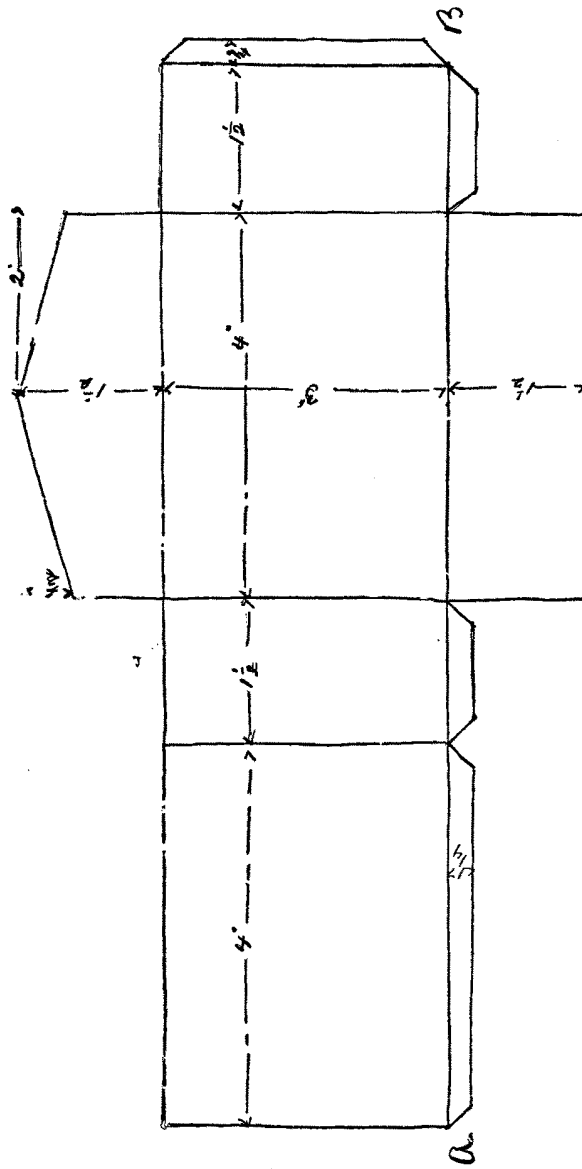
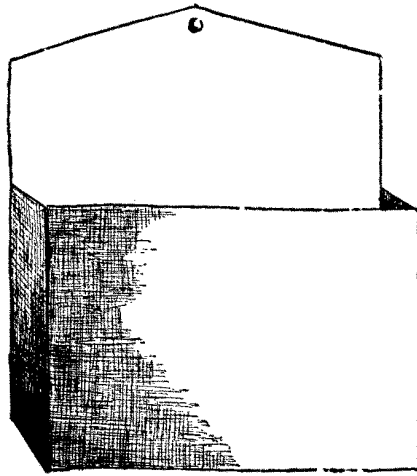

Fig. 9.

this and still another one two inches below. Cut to this line. Two inches to the right of the left edge draw a line, another one four inches, and still another one two inches. Cut to this line. Draw the diagonals of the corner squares. Cut out the triangles as indicated. The remaining ones form the laps. See Fig. 10.



Model VIII. Wall Letter Case.

Repeat this drawing on the second piece. Form the partitions from the piece cut away, making a lap one-half inch wide, and fitting as indicated by the heavy lines in Figs. 12 and 13, cutting in here to the depth of one inch. Locate the semi-circular openings in the cover as indicated at Fig. 11. Score all remaining lines, fold, glue into position, and then add the partitions.

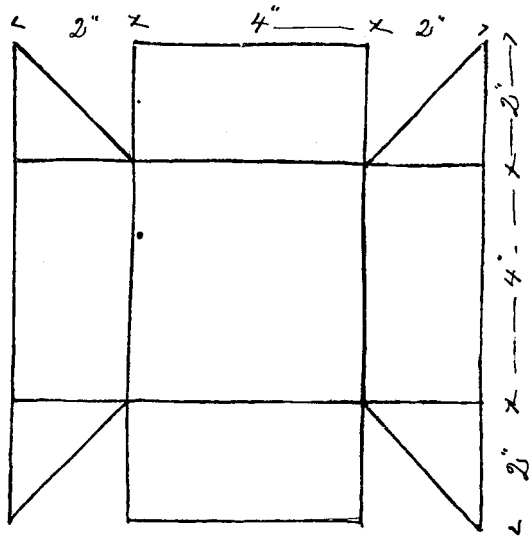

Fig. 10.

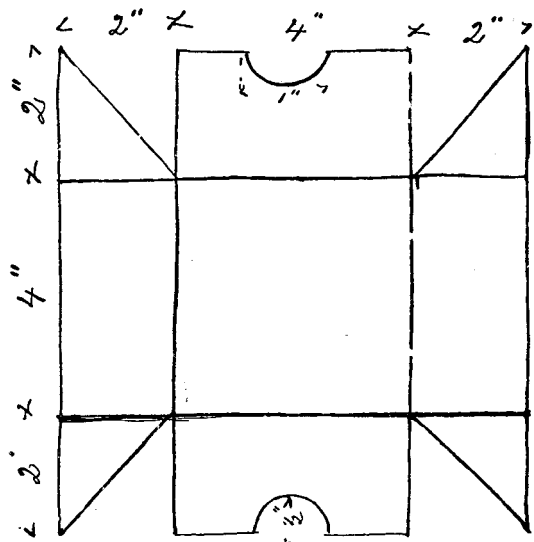
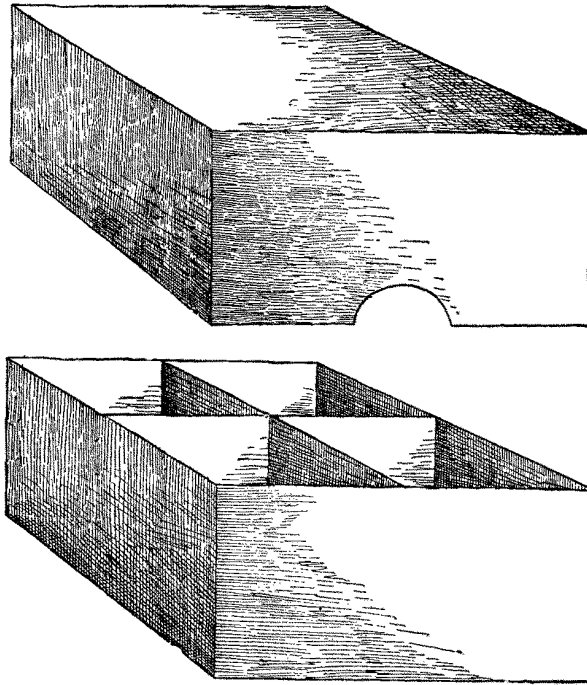

Fig. 11.



Model IX. Egg Box.



Fig. 12.



Fig. 13.

REED WEAVING.

Second Year.

Third School Year.

This line of manual work follows the weaving with paper strips, and is here introduced into the second grade (third school year). The course consists of the weaving of mats, trays, baskets of various shapes and sizes, and a complete set of doll's furniture, the making of which is interesting to boys and girls alike.

The educational value of this form of manual training can not be overestimated. First, it is pleasing to the child, and thus the desire to create is stimulated and the inventive faculties cultivated. Symmetry, form and proportion are taught, and both hand and eye trained to accuracy, while the observing faculties are aroused to notice designs and shapes in various manufactured articles.

Tools.—Scissors, knife, 1 pair flat pliers, 1 small hammer, 1 package one-inch No. 18 brads, 1 four-inch scratch awl, and a small iron vise, which, while not absolutely necessary, will prove of great convenience in holding the work for fastening.

Materials.—Round reed, Nos. 2, 3 and 4; split reed, Nos. 2, 3, 4, 6; flat and oval pith, sizes, 5, 5½ and 6½, fine cane (for binding), light linen cord and raphia.

LESSON I. FOUNDATION WORK WITH CORD.

As it is difficult for children to manage the weaving, when starting with round reed, the first lesson is given with cord as a weaving strand. For the foundation rays, use No. 2 reed. Give each pupil eight pieces seven inches long, one piece four inches long, and two yards of cord. Divide the strands into *fours*, and cross at right angles, placing the ones

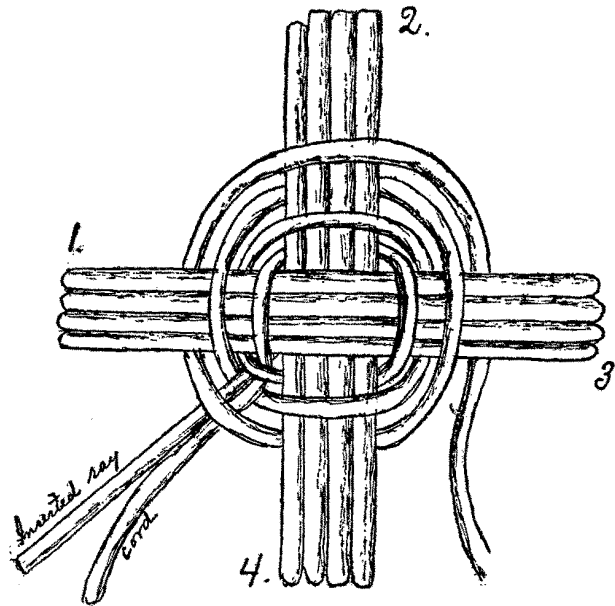

passing from left to right on top the other four, being careful to cross at centers, and hold the work firmly between the thumb and fore finger of the left hand.

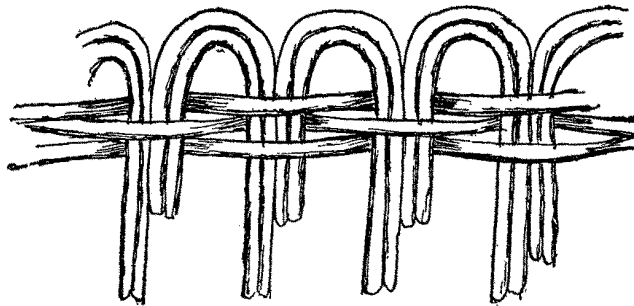

Design for a Border. No. 1.

Hold the cord as a weaver in the right hand, leaving a free end and the length of the extended arms. Pass this weaver over the four rays on the left (No. 1), then under the upper four (No. 2), over No. 3, under No. 4, and now over the cord. At this stage, insert the four-inch strand of reed, laying it alongside the cord so as to give firmness to this ray, which we treat as four. Now proceed under and over, around and around the mat, care being taken to hold the weaver firmly between the thumb and fore finger of right hand, and close up to the ray around which the cord is passing. Use the fingers of the left hand to turn the work and at the same time to press down the weaver between the rays.

Have the child first master this simple form of weaving with undivided rays before the division into twos is made.

One great advantage in starting with cord is that the work may be unwound and the material used over and over again until the pupil has learned to start his own work and weave through this step.

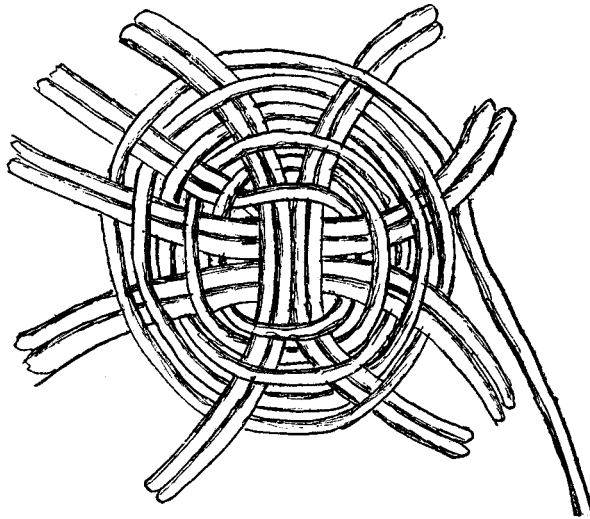

Circular Mat. Fig. 2

MODEL II. SMALL CIRCULAR MAT.

Materials.—Eight strands round reed (No. 2), seven inches long, and one strand four inches long, for foundations; one long strand (No. 2 reed) for weaving.

Before making this model, it will be necessary to soak the reed in water (warm preferred), for about two hours. This renders it as pliable as cord.

Start as in Fig. 1, inserting the short strand beside the projecting end of the weaving strand. Weave under four and over four twice around, then proceed to divide the rays into twos, beginning the division just after passing the inserted strand, and weave over two and under two. Be careful to keep equal space between the foundation rays (so as to secure symmetrical work), and also to keep the weaving thread down close to the center with the fingers of the left hand, and, by constantly turning the work, follow closely the weaving thread, which is to be held in the right hand *close to the work*. It is very necessary to emphasize these points. After weaving a mat three inches in diameter, cut the ends of the foundation rays to even lengths, and insert the scratch awl alongside each foundation ray, and into the opening thus secured, pass the

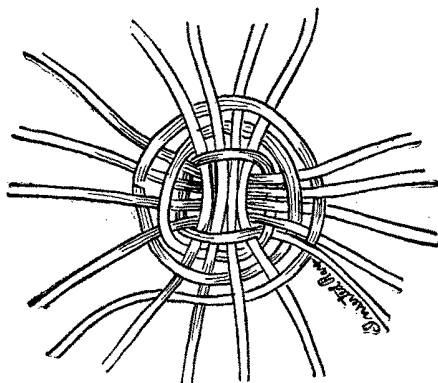

Division of rays into ones. Fig. 2.

ends, by twos, of the foundation rays; this secures the work, and makes a finish by forming loops. Flatten the mat before allowing to dry.

MODEL III.—TRAY.

Materials.—Round reed No. 2; eight pieces twelve inches and one piece seven inches long for foundation rays; two long strands for weavers.

When weaving with one strand it is necessary to have an uneven number of rays for the foundation. After starting the center, as in Lesson I., the seven-inch piece is inserted alongside the extended end of the weaving strand, and the weaving proceeds under four, over four, three times around. Then make the division by twos. (See Fig. 2). Just after passing the inserted strand and keeping the work flat, weave four times around. Now, while holding the work in both hands, press the thumbs outward and into the center of the mat, keeping the end of the weaving strand toward the right, and the ends of the rays away from the body; gradually bend them inward toward center of the bottom,—thus obtaining the desired shape. It is well to keep the first attempts at “shaping” quite shallow.

From this point divide the rays into ones (see Fig. 2), and here cut away the end of weaving strand left extended at point of insertion of the seven-inch piece; this is necessary if an uneven number of rays is required.

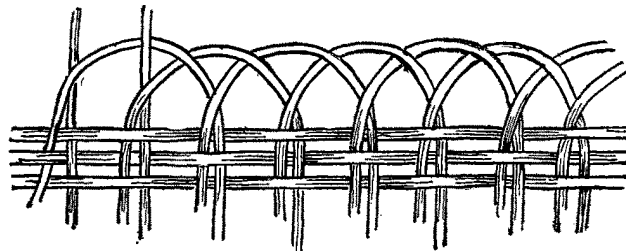

Border II.

When the end of the first weaver is reached the second one may be spliced on by laying the end of the new weaving strand alongside the end of the first.

Do not place the ends of weavers down by the side of the foundation rays, until the work is complete, when the final end may be passed down, in order to close the work. Finish with border II.

BORDER II.

After trimming the ends of the rays to even lengths—(about three inches), pass the end of each standing strand behind the first one to the left, in front of the second one, and down by the side of this one. It may be slipped down beside the second one before passing in front of it, if preferred.

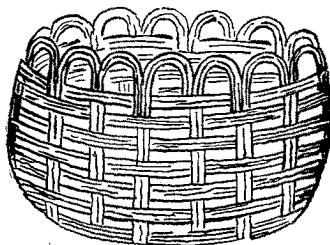

MODEL IV.—SMALL BASKET.

Materials. — Round reed, Nos. 2 and 3; three long strands No. 2 reed for weavers; eight pieces fourteen, and one piece eight inches long (No. 3 reed), for foundation.

After starting as in Lesson I.,—and making division of twos, as in Model II., weave over two and under two until the bottom is two and one-half inches in diameter.

Now turn up the sides of the basket sharply and continue to weave to end of strand. Finish with border I. As it is desirable to have the weaving strands soft and pliable, a pail of warm water should be standing in the class-room and the weaving strands placed in this until needed.

In all these simple lessons the shaping is done entirely by the hand, thus training the hand to deftness and exactness, and the eye to symmetry and proportion.

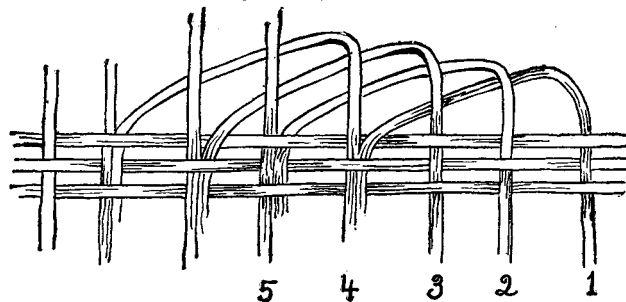

BORDER III.

Pass ray No. 1 behind Nos. 3 and 4 and down by the side of No. 5. Pass No. 2 behind Nos. 3 and 4 and down by the side of No. 6 — and continue until the last ray is passed down.

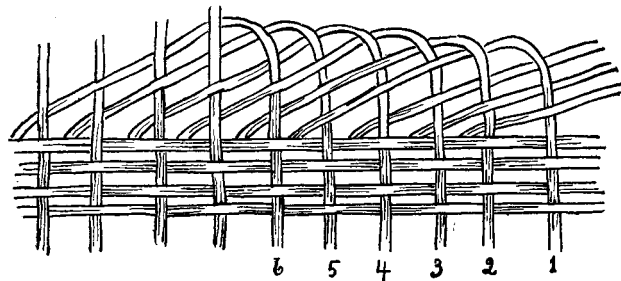

BORDER IV.

Take any standing ray as No. 1, pass it behind No. 2, in front of No. 3 and then down into the basket. Now pass No. 2 behind No. 3, in front of No. 4, and down into the basket, leaving these two loops open in order to receive the last two ends. Press the other loops down flat, and when completed trim the ends to even lengths, leaving about one inch in length inside the basket. Length of spoke for border, four inches.

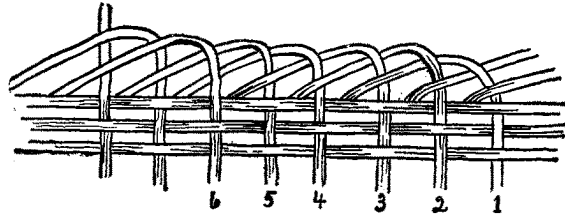

BORDER V.

Take any ray as No. 1, pass it behind No. 2 and No. 3, in front of Nos. 4 and 5, and then down inside the basket. Then pass No. 2 behind Nos. 3 and 4, in front of Nos. 5 and 6, and down inside the basket. Continue to the end, weaving the last two into the loops formed by Nos. 1 and 2. Length of spoke for border, six inches.

BORDER VI.

Length of rays needed for this border, nine inches. Place ray No. 1 *behind* No. 2, and bring the end down under the thumb of the left hand. Then lay No. 2 behind No. 3.

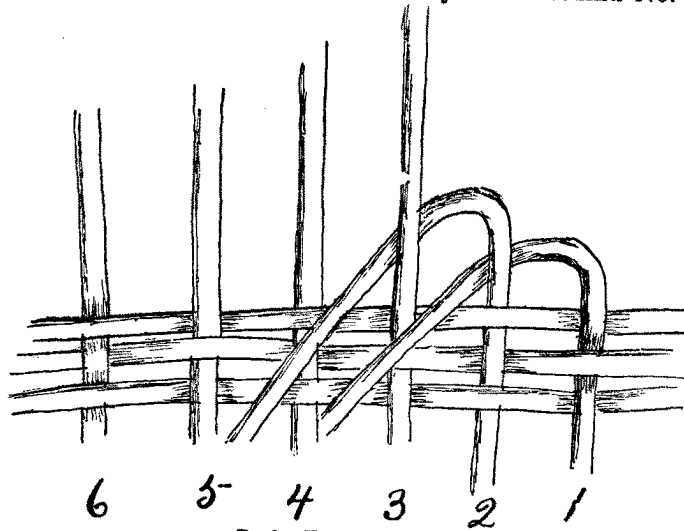

Border VI. Detail No. 1.

Now go back to No. 1 and pass it *before* No. 3, and *behind* No. 4, bringing the end down in front of the basket, and hold it here, while laying No. 3 (which is the first one standing)

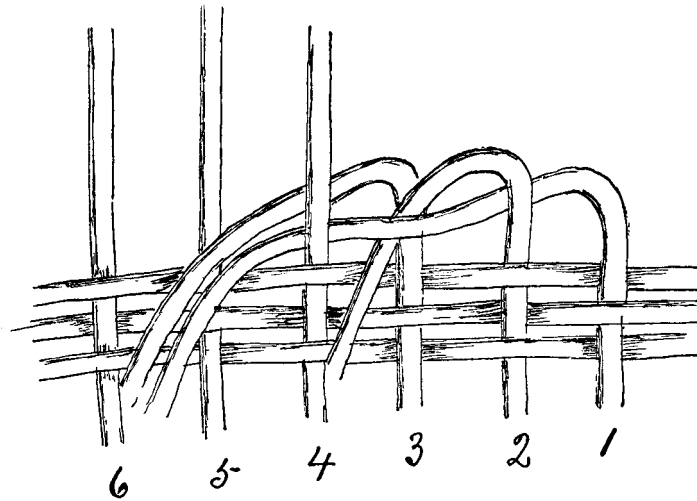

Border VI. Detail No. 2.

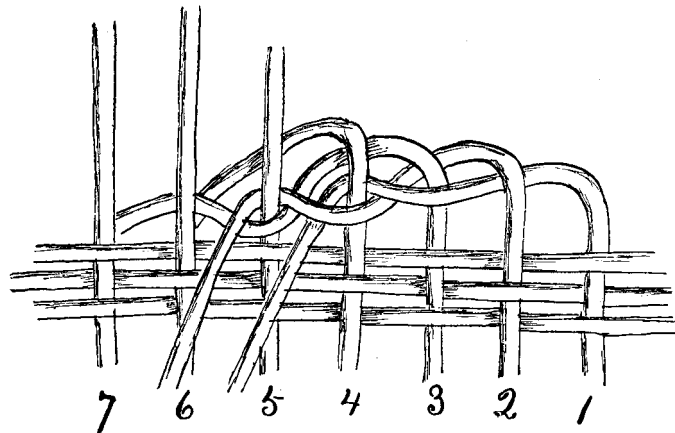

Border VI. Detail No. 3.

down alongside of No. 1. Now take No. 2 and pass it in *front* of No. 4 and behind No. 5, and lay No. 4 (still standing) *behind* No. 5, and down beside No. 2. It will now be observed that the ends of the reeds are forming sets of *twos*. Now begin with the first pair, and take the longer of the two reeds, and pass it in *front* of No. 5 and *behind* No. 6, and down in front; then turn No. 5 down *behind* No. 6 and alongside the end just turned down. Continue in this manner until but one end is standing, when we are ready to close the border. Now take the longer one of the last *two* and place it in front of No. 1 (which was the first spoke used), and bring the end out in front under No. 2. Take the longer end of the set of *twos* and place it in front of No. 2, and bring this end out in front under No. 3. The ends may now be cut off in front, or woven back and cut off on the inside of the basket.

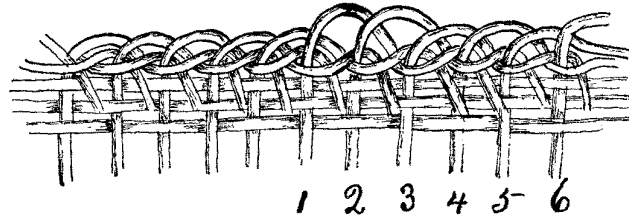

Border VI. Detail No. 4.

USE OF TWO WEAVERS.

The entire depth of the sides of a basket may be woven with *two weavers*, or this style may be used at the bottom of the basket, where the spokes are turned up. It also adds to the appearance of the basket if two or three rows, using two weavers, are inserted just after braided rush or straw has been used.

To work with two weavers, one end of each is inserted *behind* two successive rays, or spokes, as at A, then each, in

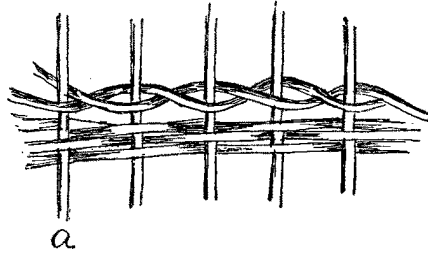

Use of Two Weavers.

turn, is brought in *front* of one and *behind* the next one, as indicated in the drawing.

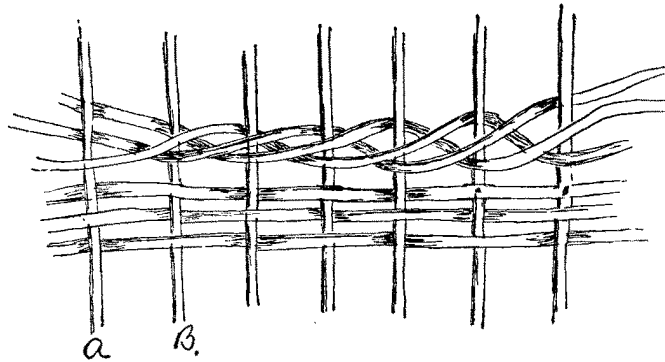

Use of Three Weavers.

USE OF THREE WEAVERS.

Insert three single weavers, *behind* three successive spokes, as at A and B, and place each, in turn, in *front* of the next two rays, and *behind* the third. This style of weaving is used especially to strengthen the work at the point of turning up for the sides, where it not only hides the ends of any additional rays added at this point, but it strengthens the basket.

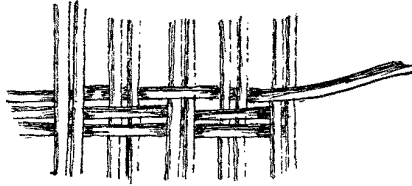

Double Weaving.

DOUBLE WEAVING.

An effective style of weaving may be worked by using an even number of rays, and passing, with a single weaving strand, *under one, over one, two or three times around*, and then alternate for another two or three rows. This alternation must always be made on the under side, and is effected by passing under *two* rays, and then on, over one and under one.

This is most effective when the spokes are double or treble, according to the number of rows used before the change is made. If, in order to make the bottom of the basket of sufficient strength and size, a division of *ones* has been made, the extra ray (for additional spokes) may be added at the point

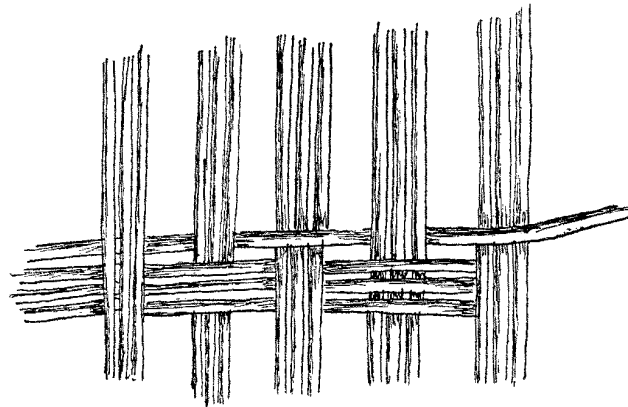

Triple Weaving.

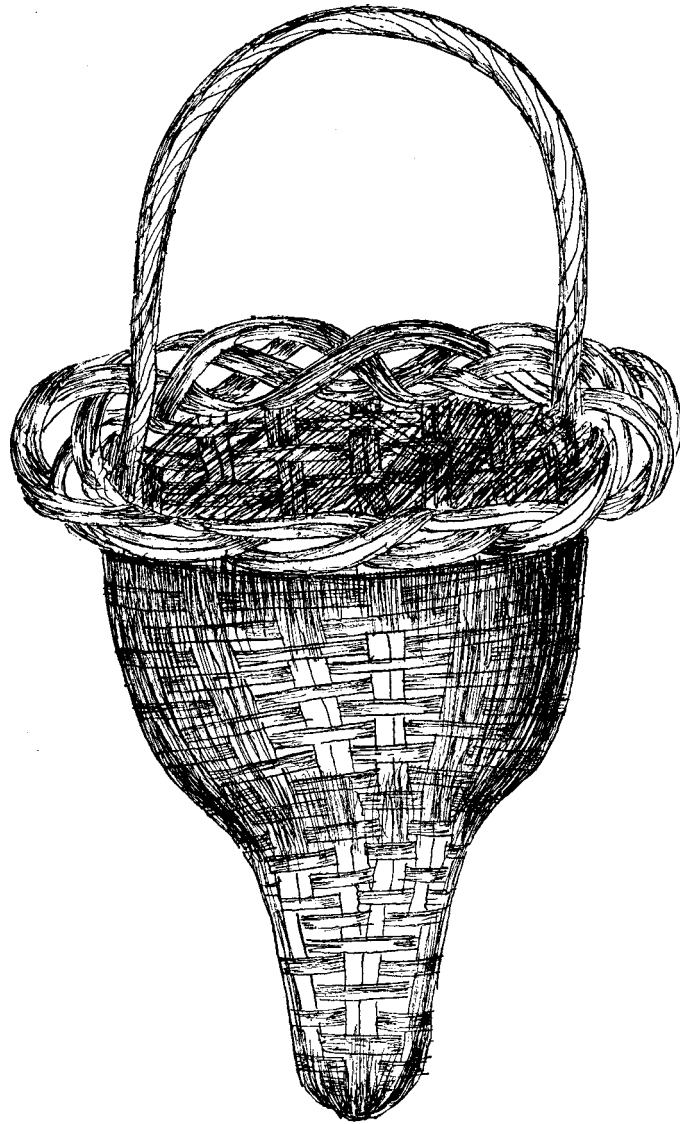

Flower Basket.

of turning up the rays for the sides, and here working in three rows of triple weaving (three weavers), and then proceed with the single weaver two or three times around.

FLOWER BASKET.

For the foundation use No. 4 reed, eight strands twenty-seven and one strand fourteen inches in length. Use No. 2 reed for the weavers. Begin the division of *twos* immediately after fastening the center. As the lower part of this basket is not more than one inch in diameter at the base, it is necessary to begin to form this part by turning back the rays at the beginning of the weaving. When the elongated part is the desired length, the division of *ones* is made, and after weaving but *once* around, an extra spoke is inserted alongside each single one. This is done so as to give solidity to the basket, and also to make a heavier border than is possible with single spokes. The sides are now turned outward and then upward. When the basket is the desired size, the ends of the spokes should be dampened and then turned at right angles with the basket, and here finish with border No. 3. This produces a *flat* finish to the border. The handle is formed by inserting a piece of No. 4 reed into the sides of the basket, and upon this, twisting back and forth, a length of No. 2 reed, until the foundation is hidden and a rope-like appearance is given to the handle.

CONSTRUCTION IN CARDBOARD.

THIRD YEAR.

Fourth School Year.

MODEL I. — BILL HOLDER.

Material. — Essex bristol; size, 12 in. x 9 in.

Place the paper with its long edges parallel with the edge of the desk. Lay off the vertical lines, forming the spaces, one-quarter inch, two inches, three and one-half inches, two inches and three and one-half inches. Cut to the last line.

From the upper corners, measure down two and one-half inches, draw a line, and from here measure down three and one-half inches, again draw a line, and from here measure two inches, and, again, one-quarter inch, draw lines and cut to the last one. See Fig. 1.

From points A and B measure one-half inch, place dots and draw lines to points C and D, as shown in the drawing. Cut away all

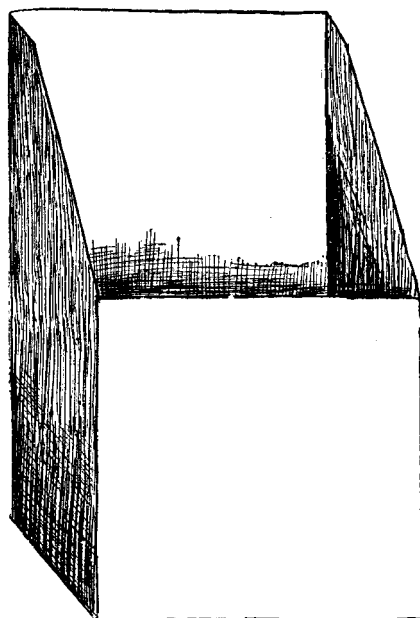

Model I. Bill Holder.

MODEL II.—COMB CASE.

Material.—Essex bristol ; size 8 in. x 8 in.

From the upper left corner proceed to lay off the vertical spaces, two, three and one-half, and two inches wide. See Fig. 2. From the two upper corners measure down and lay off the horizontal spaces two, two, one, and two and one-fourth inches wide. Cut to the last line. Cut the squares away from the upper corners. Measuring *in* one inch and *down* one-half inch, draw lines and cut off the corners of the projecting piece, as shown in the drawings. From points A and B measure *out* one inch, place dots, and draw lines from these dots to the upper corners. Cut to these lines. From

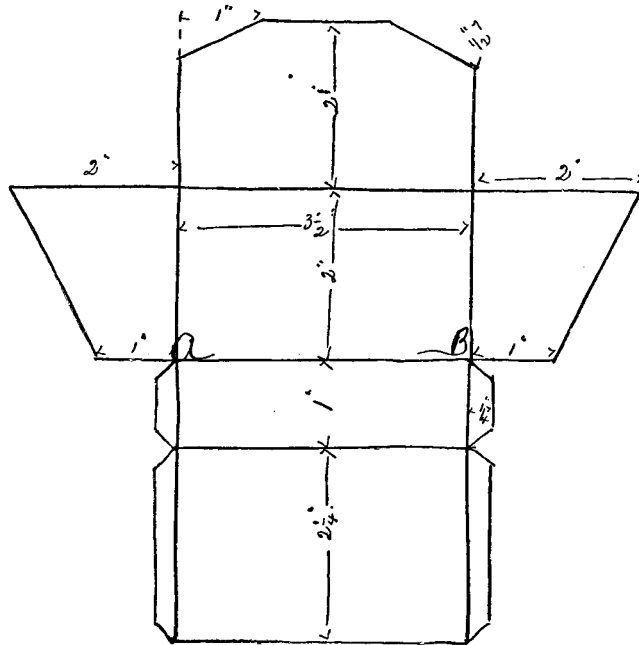
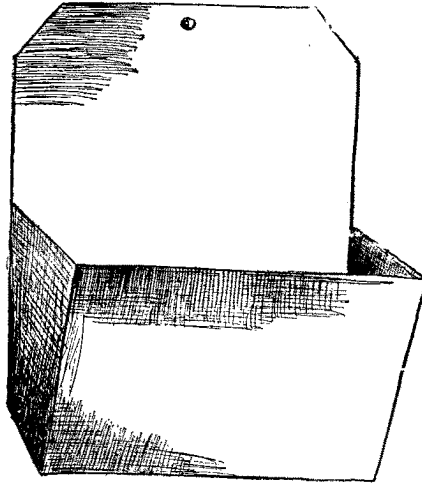

Fig. 2.

points A and B lay out the one-quarter-inch laps. Cut to these lines and shape as indicated. Score all lines excepting the one across the back. Fold into shape and glue.



Model II. Comb Case.

MODEL III.—CORNER BRACKET.

Material.—Essex bristol; size, 11 in. x 7 in.

Place the paper with its short edge parallel with the edge of the desk. Find the middle of the upper and lower edges and draw a line across. Measure three inches down from the upper corner and draw a line across. From the point of intersection of the two lines measure three inches to

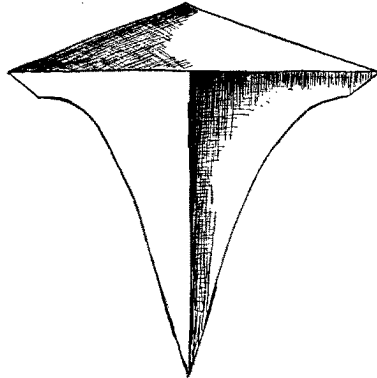

Model III. Corner Bracket.

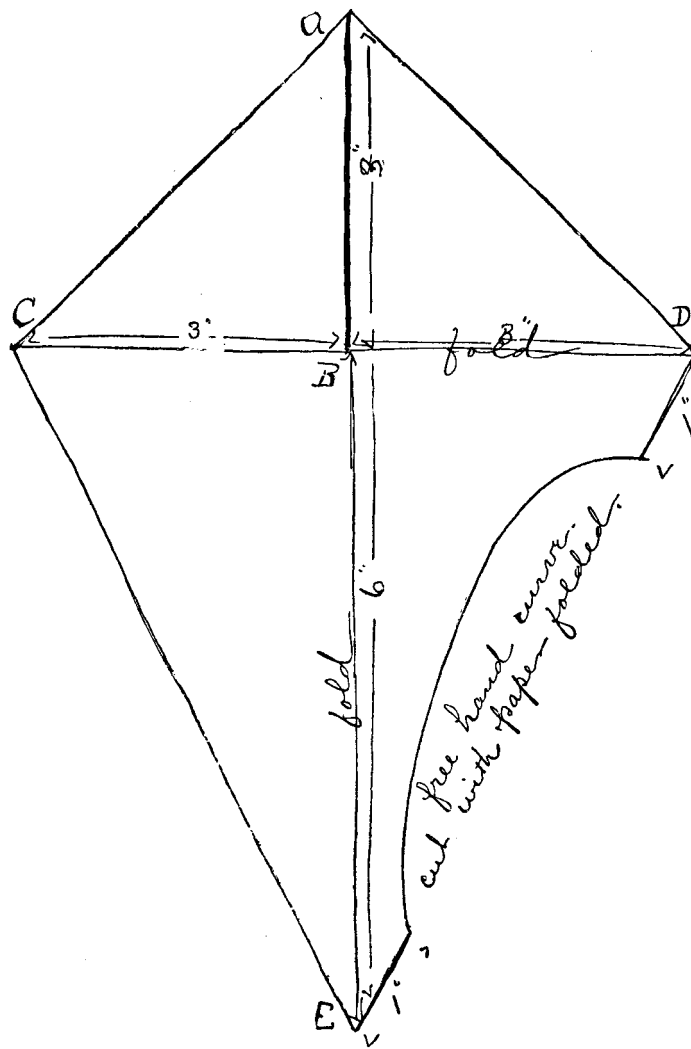

Fig. 2.

the right and left, place dots, and draw lines from these dots to point A. See Fig. 3. Cut *to* these lines and cut *in* on line A-B. From B measure down six inches, place a dot, and draw lines from this dot to the ends of line C-D. Score the remaining lines and score through the center line. Measure one inch down from D and up from E. Locate dots and cut the curve from these points.

MODEL IV.—CANDY BOX.

Material.—Essex bristol ; size, 12 in. x 8 in.

Place the paper with its short edge parallel with the edge of the desk. From the upper corners measure down and lay off the horizontal spaces, viz. : three, one and one-half, three, one and one-fourth, and one and one-fourth inches each. Cut to the last line. See Fig. 4. Lay off the vertical spaces, one and one-half, four, and one and one-half inches each. Locate the middle of the upper edge, and cut the semi-circular opening. Bisect the lines A-B and C-D and from the point of bisection measure out one inch, and from these points draw lines to A, B, C and D. Cut to these lines. Cut away the oblongs from the lower corners. Round the corners of the pro-

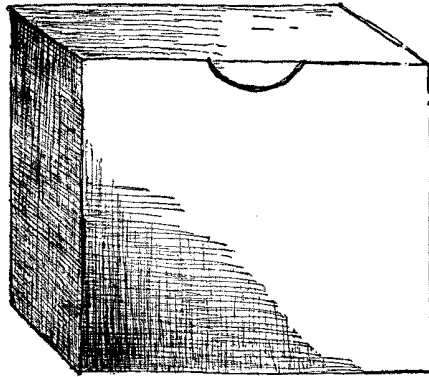

Model IV. Candy Box.

jecting piece. Score all remaining lines and fold to place.
This box may be glued to shape if preferred.

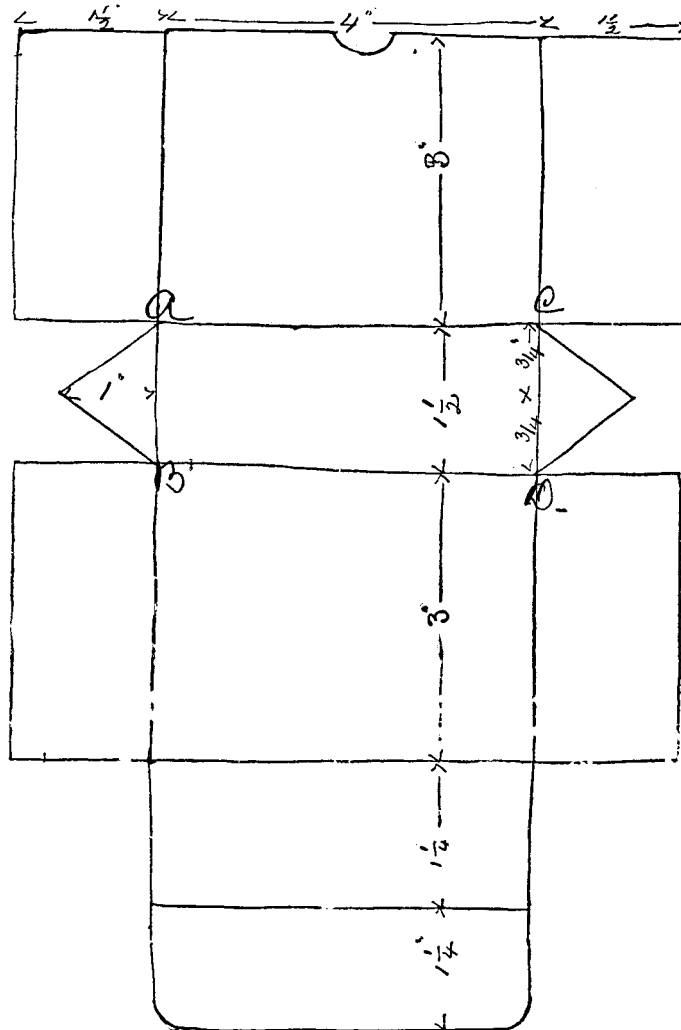

Fig. 4

MODEL V.—FOLDING BOX.

Material.—Essex bristol ; size, 13 in. x 8 in.

From the upper corners lay out the horizontal spaces, viz. : two and one-half inches, one inch, two and one-half inches and one inch each. See Fig. 5. From the upper left corner measure off the vertical spaces, viz. : two and one-half, three and one-half, two and one-half, three and one-half and one-half inch each. Cut away all waste, leaving the projecting

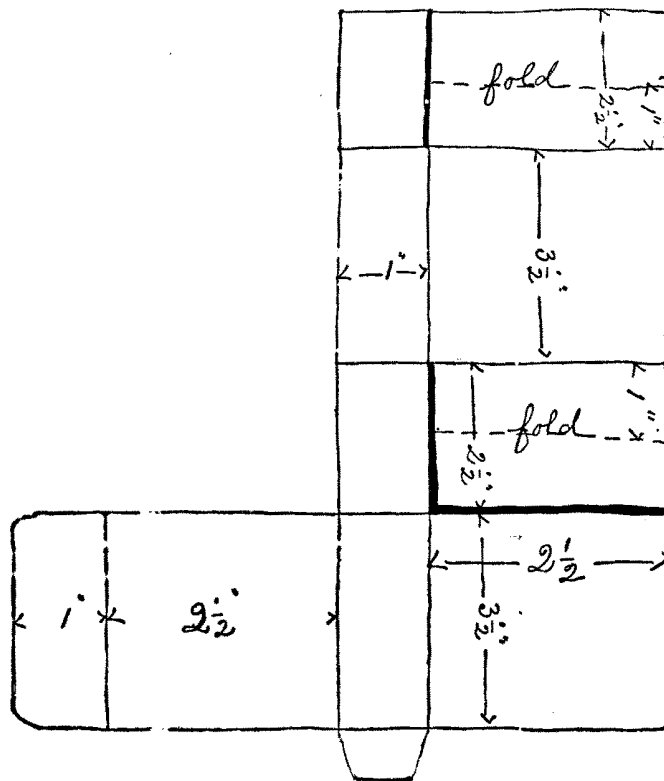
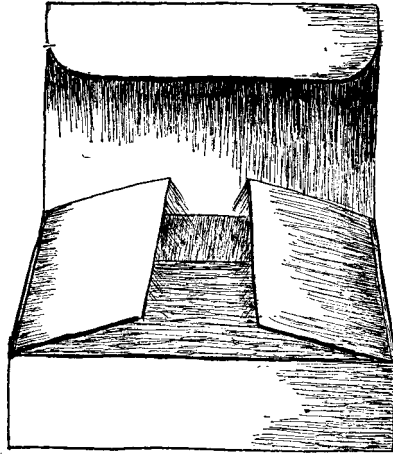

Fig. 5



Model V. Folding Box.

piece at the bottom. This forms the cover and the tongue (or the piece to slip inside the edge of the box). The piece projecting at the right forms the lap.

Cut *in* on all heavy lines, as indicated by the drawing, and *fold* and *crease* on all *dotted* lines. Now bring the box into shape as shown in the sketch. Place glue

on the one-half inch lap and fasten.

MODEL VI.—LUNCH BOX.

Material.—Essex bristol ; size, 9 in. x 8 in.

From the upper corners measure down and draw lines for the horizontal spaces, viz. : two, three, and two inches each. Cut to the line drawn last. See Fig. 6. From the upper left corner lay off the vertical spaces, viz. : one and one-half, two, one and one-half, one-half and one inch each. Cut to the line drawn last. From points A and B measure *up* one and one-half inches, place dots, draw line across and cut to this line. Cut *in* on the lines A-X and B-X. Repeat this on opposite side at points C and D.

Cut *in* to form the laps on the cover, making this lap one-half inch wide,

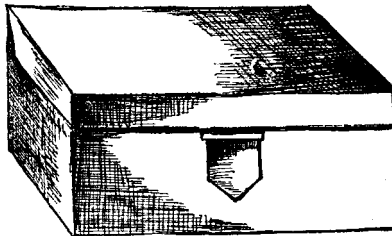

Model VI. Lunch Box.

with a projecting tongue of one inch (pointed at the end). Fold into shape, cut the openings in the front edge of the box and pass the tongue through this. Glue into shape.

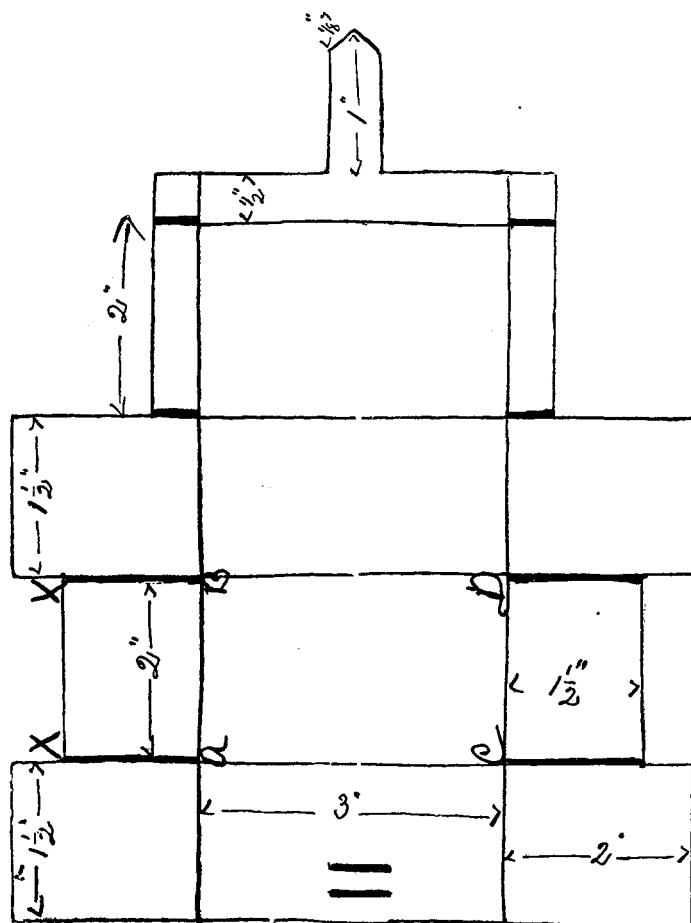

Fig. 6.

MODEL VII.—HAT BOX.

Material.—Manilla paper; size, 6 in. x 6 in.

Laying the rulers along the edge of the paper, place dots at every one and one-half inch space. See Fig. 7. From these dots draw slanting connecting lines to the right and left. Draw these in either as dotted or light lines. Now make *heavy* all lines reaching from the outside edge to the *first* point of intersection, and cut to these lines, as shown in the drawing. Cut *in* on the diagonal lines at points A, B, C and D. The triangles thus formed are used for *laps*. The square touched on the

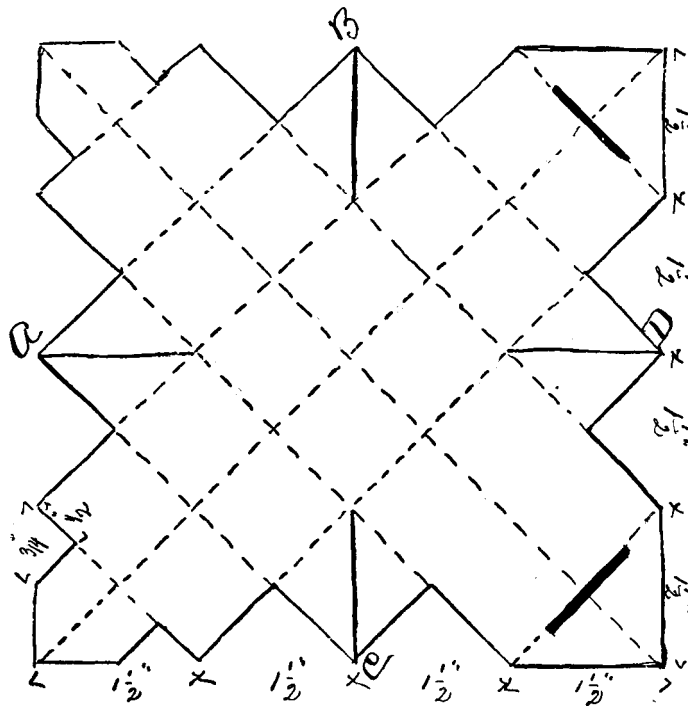
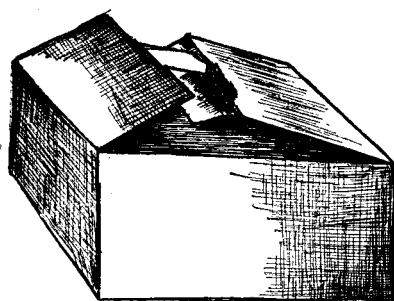

Fig. 7.



Model VII. Hat Box.

corners by these triangles forms the bottom of the box. Crease on the lines around this square and turn the paper up to form the sides of the box. Now crease and fold over for the covers. An opening is made in two adjacent corners and through these the pointed end of the

tongue is passed. This model requires no gluing.

MODEL VIII.—TABOURETTE I.

Material.—Strawboard; size, 10 in. x 8 in.

From the upper and lower left corners measure off the vertical spaces (two inches each), and draw lines across; now add the one-half-inch space for the lap and cut to this line.

From the upper corners measure down one-half inch and draw a line across; this space forms the top lap. From this line measure down three inches, draw a line across and cut to this line. From the top edge measure down one and one-half inches and draw a *light* line across. This line is crossed by the vertical lines. Measure one inch to the right

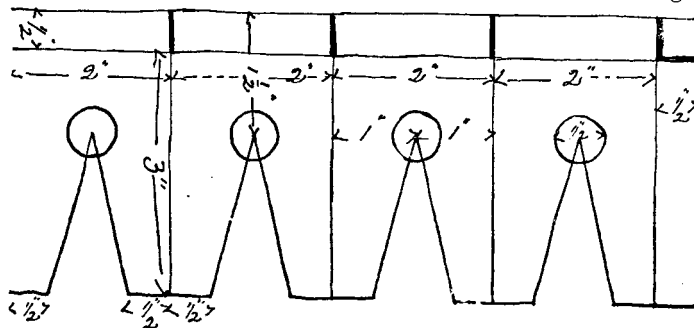
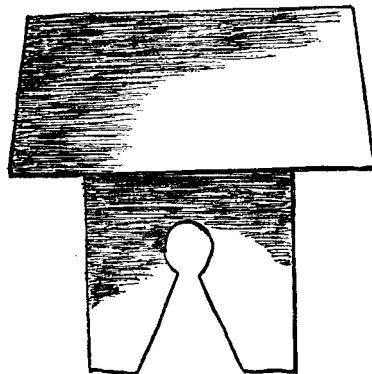

Fig. 8.

and left of the point of intersection and here place a dot. With a compass describe a circle one-half inch in diameter, using the dot as a center. From the lower left corner meas-



Model VIII. Tabourette I.

ure *in* one-half inch and place a dot. Measure one-half inch to the right and left of the lower ends of the vertical lines and here place dots. From these dots draw lines to the center of the corresponding circles and cut to these lines, and then cut out the remainder of the circle. Score all vertical lines, and score and turn to a right angle the one-

half-inch space, first cutting in on the heavy lines. Glue to shape.

From the waste piece cut a square four inches by four inches. Draw a line one inch in from all edges. This line

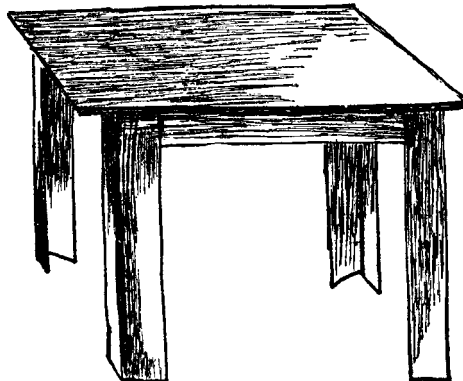

Model IX. Kitchen Table.

indicates the position of the framework. Glue the four-inch square to the top of the framework.

MODEL IX. — KITCHEN TABLE.

Material. — Straw board; size, 16 in. x 8 in.

From the upper and lower left corners measure off the vertical spaces, three, four, three and four inches, and again one-half inch. See Fig. 9. Draw lines across, and cut to the last line. From the upper corners measure down one-half inch and draw a line across. Cut in on the heavy lines above this horizontal one. From this line measure down three and one-half inches and draw a line across. Cut to this line.

From the horizontal line measure down one-half inch and draw a line across. Locate points A, B, C and D. Measure one-half inch to the right and left of these points, and repeat this at the lower ends of the vertical lines. Draw lines connecting these dots, and cut to these lines.

Score all vertical lines, and the remaining horizontal line. Glue to shape. From the waste piece cut the top of the table, size five inches by four inches. Draw a line one-half inch in from all edges, and glue this piece to the foundation.

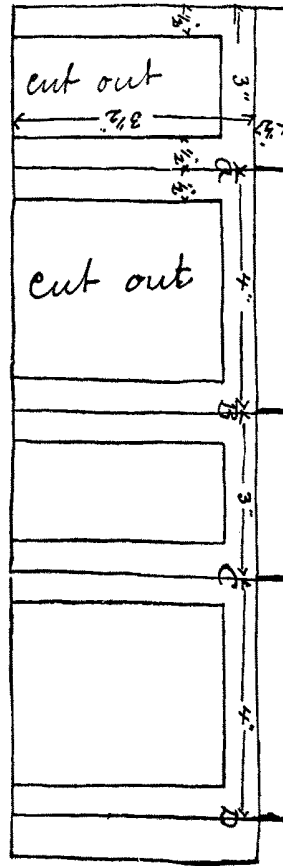

Fig. 9.

MODEL X. — TABOURETTE II.

Material.— Essex bristol; size, 8 in. x 8 in.

From the upper corners measure down one-half inch and draw a line across. From this line measure down three inches, draw a line across and cut to this line. See Fig. 10.

From the upper and lower left corners measure to the right for the vertical spaces of one and one-half inch each, and the one space one-quarter inch wide. Draw lines and cut

to the last line. From the horizontal line measure down one inch and draw a line across. Locate points A, B, C and D.

Measure three-fourths inch to the right and left of these points and here place a dot.

From the lower left corner measure to the

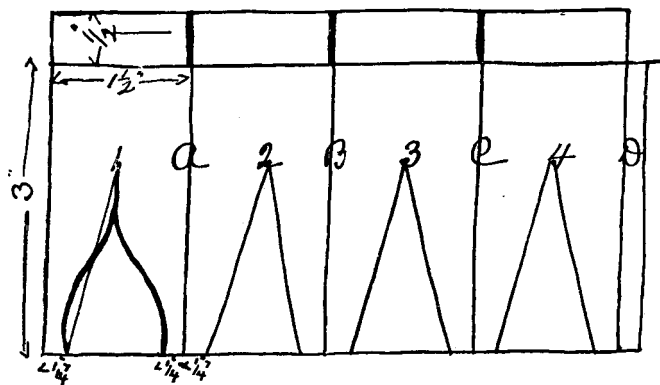
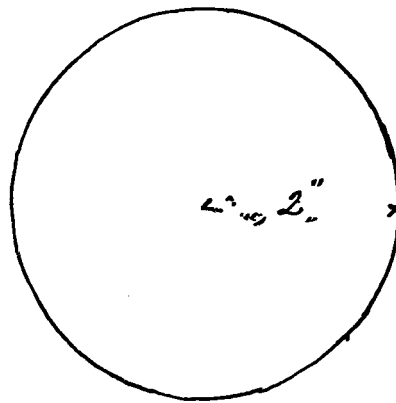
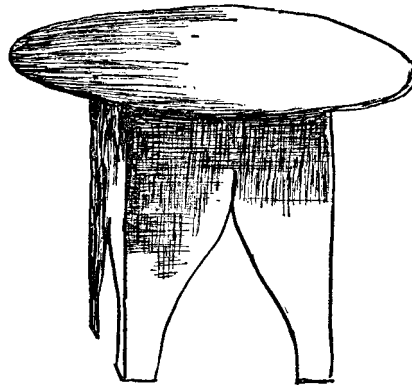

Fig. 10.

right one-quarter inch and also measure one-quarter inch to the right and left of the lower end of each vertical line and place dots.

Draw lines from these dots to the dots at points 1, 2, 3 and 4.

Find the middle of these lines and draw a compound curve. Cut to these curved lines. Score all vertical lines, and also the line forming the edge of the top lap. Glue to shape. From the waste piece cut a circular top, four inches in diameter, and glue it to the framework.



Model X. Tabourette II.

MODEL XI.—TABOURETTE III.

Material.—Essex bristol; size, 10 in. x 8 in.

From the upper corners measure down one-half inch and draw a line across. From this line measure down two and one-half inches, draw a line across and cut to this line. From the upper and lower left corners locate dots for the vertical lines one and one-half inch apart, and one space one-quarter inch, to form the lap. Draw lines connecting these dots, and cut to the last line. From the horizontal line measure down three-quarters of an inch and draw a light line across. Locate

points A, B, C, D, E and F. Measure three-quarters of an inch to the right and left of these points and place a dot. From the lower left corner measure to the right three-eighths of an inch, and the same from the lower ends of the vertical lines.

Draw freehand curves in one of the vertical spaces as indicated in Fig. 11. Cut to this curve. Score all vertical lines. Place the section containing the curves *over* each of the other sections, and trace around the curved lines, thus forming the six legs. Glue to shape.

For the top use the waste piece, and on this describe a hexagon on the given base, one and one-half inches. Take the line A-B, one and one-half inches in length. With a radius equal to the length of A-B, describe arcs, using the ends of the line as centers.

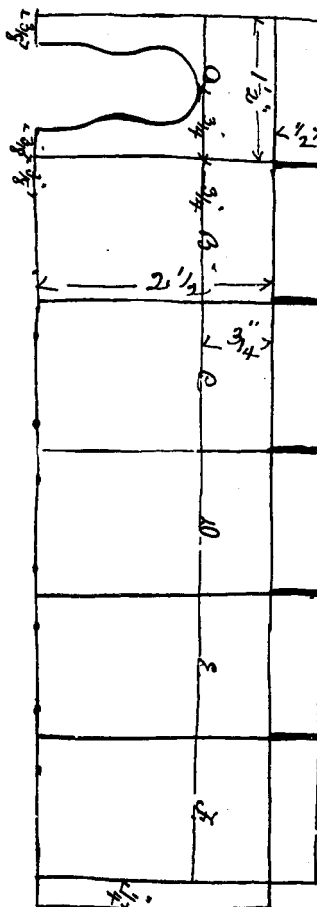

Fig. 11.

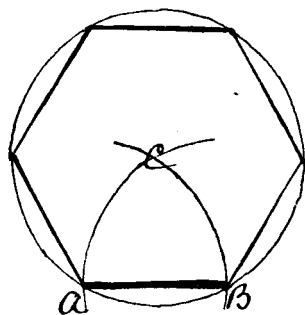

Fig. 12.

The arcs cut each other at point C. With C as center, and the same radius, describe a circle. Beginning at B, set off this space, around the circumference of the circle. Draw lines connecting these points, as in Fig. 12.

MODEL XII. — CHAIR.

Material. — Essex bristol; size, 11 in. x 8 in.

From the upper corners measure down one-half inch and draw a line across. From this line measure down three-eighths inch and draw a line across; again, from the *same line*, measure down two and one-half inches, draw a line, and cut to this line.

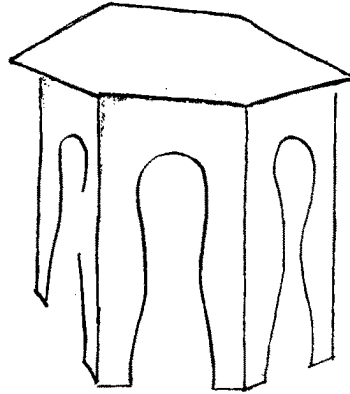

Model XI. Tabourette III.

From the upper and lower left corners, measure to the right three-eighths of an inch, locate points A, B, C and D. From these points measure three-eighths of an inch to the right and left, and here place dots. From the lower ends of the vertical lines measure the same distance, place dots and draw lines connecting these dots to the dots above. *Cut out* as indicated in Fig. 13, and cut *in* on the heavy lines. Score the vertical lines, and the lines forming the edge of the lap. Fold, and glue to shape. Use the piece cut away for the back and seat.

Place this piece on the desk with its short edges parallel to the edge, and draw a center line. From the upper corners measure down six inches, and draw a line across. Cut to this line. Locate points A and B, and from these points measure one and three-fourths inches to the right and left,

and here place dots. Draw lines connecting these dots, and cut to the lines.

From the lower corners of the paper measure up two and one-half inches, place dots, and draw a line across. Locate

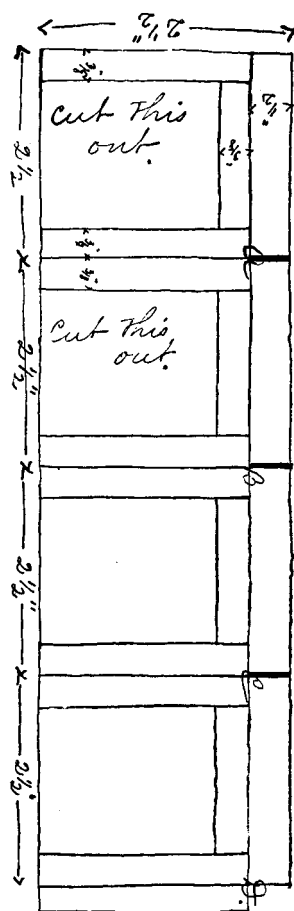

Fig. 13.

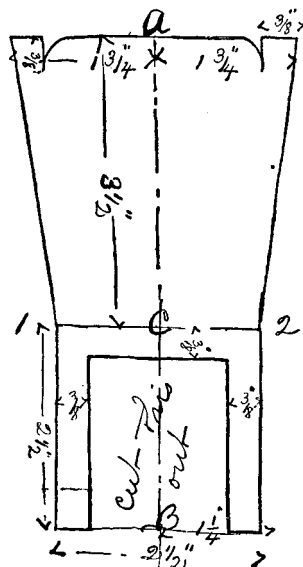

Fig. 14.

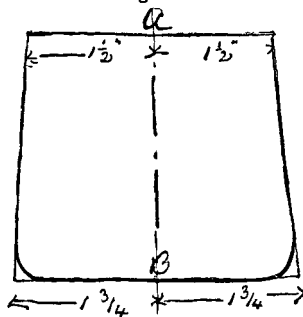

Fig. 15.

point C. From points B and C measure to the right and left one and one-quarter inches, and draw vertical lines connecting these dots. Now from the dots at ends of line C draw lines to the upper corners, and cut to these lines.

From points 1 and 2 measure in three-eighths of an inch. Measure the same from the lower corners, and draw connecting lines. From points 1 and 2 measure down three-eighths of an inch, draw a line across, and *cut out*, as indicated in Fig. 14.

From the upper corners measure *in* three-eighths of an inch, place dots, and from these dots measure *down* three-eighths of an inch. Shape the top as indicated, and glue this back to position. Use for the seat of the chair the remaining piece cut away.

Locate points A and B on the center line. From point A, measure one and one-half inches to the right and left, and here place dots. From point B, measure one and three-fourths inches to the right and left, place dots and draw the connecting lines. Round off the corners, as indicated in Fig. 15, and glue to position.

MODEL XIII.—BED.

Material.—Essex bristol; size, 11 in. x 8 in.

From the upper and lower left corners measure in for vertical lines, three-fourths of an inch, five

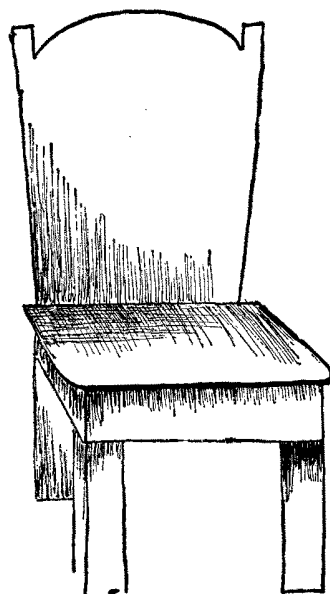

Model XII. Chair.

inches and again three-fourths of an inch. See Fig. 16. Cut to the last line. From the upper corners measure down three-fourths of an inch, three inches, and again three-fourths of an inch. Cut to the last line. Cut in on the heavy

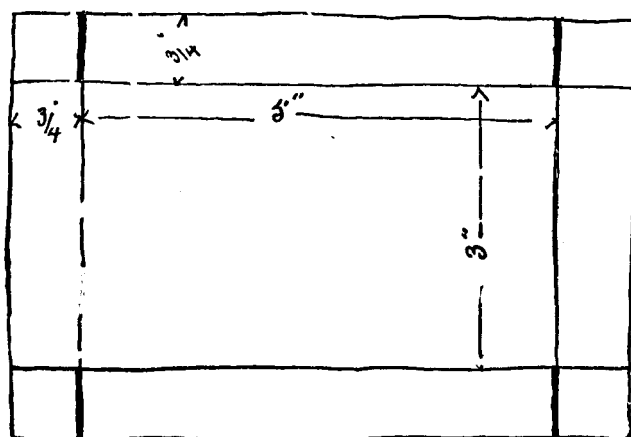

Fig. 16.

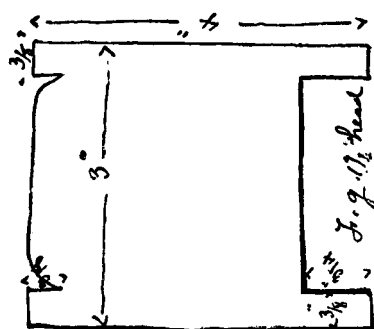

Fig. 17.

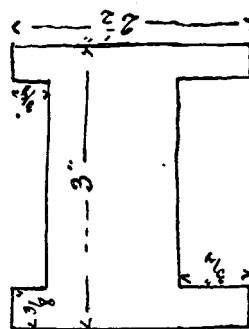
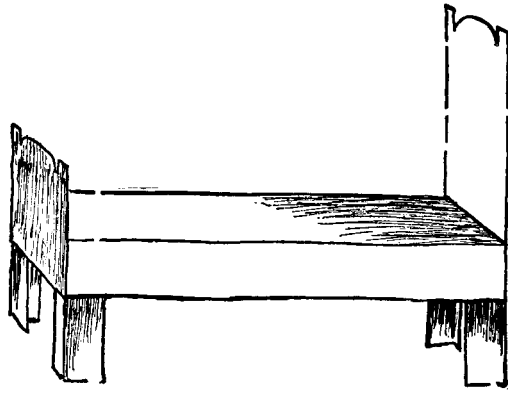

Fig. 18.

lines, score all remaining lines, fold and glue. Using the waste piece, lay out the drawing for the head and footboards, as indicated in Figs. 17 and 18. Cut to shape and glue to position.



Model XIII. Bed.

COURSE IN RAPHIA.

This course may be introduced into the fourth school year, but should not be given to the pupils until the muscles of the hand are strong enough to permit the use of a large darning needle for sewing. Raphia is the inner fibrous bark of a species of palm found in Madagascar. It is sold in twists,

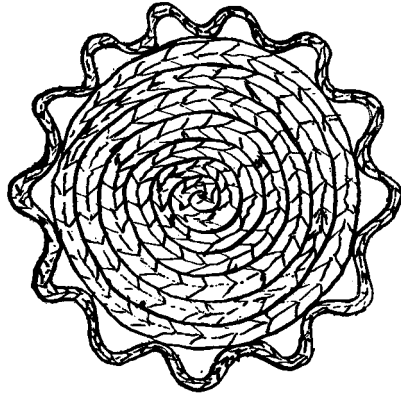

Model I. Round Mat.

As the raphia is braided before sewing, in order to facilitate this, we allow the girls to sit before screw hooks, fastened at intervals, in the wainscoting, on which they hang the strand while braiding. As the raphia is uneven in width, a certain thickness of braid must first be decided upon as standard for each model, and as many strands of the material used as are necessary to plait a three-strand braid of the desired thickness. The lengths are added by splicing, not by tying, and each pupil may alternately plait and sew, as it is not necessary to plait the full length needed before the sewing is started.

varying in size and weight from two to five pounds, and in price from fifteen to twenty cents a pound. Ten pounds will furnish material for a class of fifteen girls for this entire course, which may be given during the period when the boys have shop work.

Materials required are scissors, No. 5 darning needles, and raphia.

Small tags, to be found at a stationer's, and costing about ten cents a hundred, are marked with each pupil's name and fastened to her work. By using dyes, many artistic colors may be produced and these colored strands used for the entire model, or for sewing, etc.

MODEL I.—ROUND MAT.

The braid is laid flat and sewed edge to edge, with a large darning needle, and for thread the finest strands of raphia, which are not to be used in the braiding, but should be reserved for sewing. Have the sewing all done on one side—and not loosely—the teacher examining the work frequently in order to insure even, close sewing.

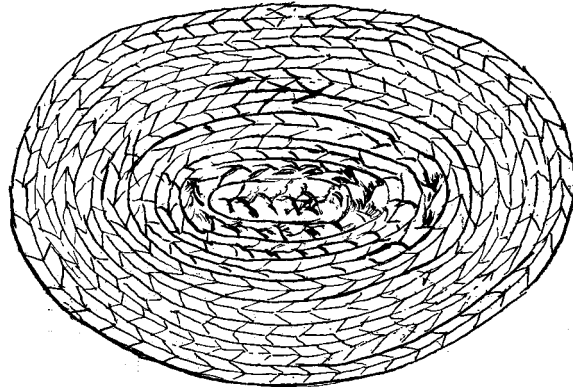

Model II. Table Mat.

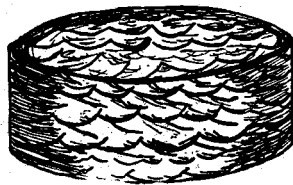

Model III. Napkin Ring.

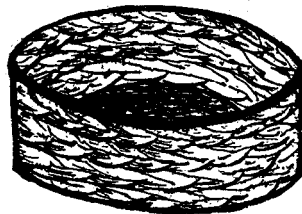

Model IV. Circular Tray.

After sewing to the desired size, six inches in diameter, add a border. This may be made either by sewing the braided strand in single or double points or scallops, or by making a fringe of the unbraided raphia, fastening it into the edge with a buttonhole stitch. By catching the edge together in three different places this may be converted into a very useful basket.

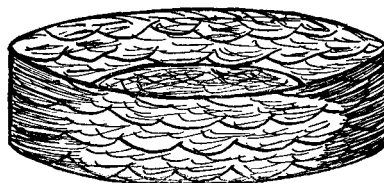

Model V. Elliptical Tray.

MODEL II.—TABLE MAT.

This varies from Model I. in shape, being elliptical, and in manner of sewing, as the braid is sewed together with the flat sides touching, and edges up. A complete set of useful table mats may be made, varying in size.

MODEL III.—NAPKIN RING.

For this exercise the braid is sewed together with the face sides touching; sizes may vary.

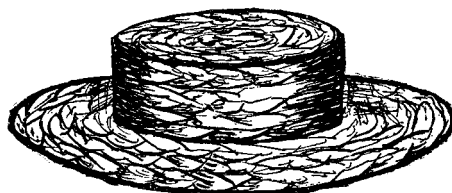

Model VI. Sailor Hat for Doll.

MODEL IV.—CIRCULAR TRAY.

Diameter of bottom, four inches. Depth of side, one inch.

If the braided strand is very coarse the edges may be sewed together; if fine, the sides are joined. After making the bottom the desired size, add the side to the depth of one inch, sewing round and round to the edge of the bottom, and frequently allowing the stitches to pass through the entire depth of the side. This gives firmness to the finished work.

MODEL V.—ELLIPTICAL TRAY.

Length of bottom, five inches. Depth of side, one and one-half inches. Follow directions for Model V.

MODEL VI.—SAILOR HAT FOR DOLL.

This is started as in Model III., but the braid must be sewed flat, *i. e.*, with edges touching. Trimming may be added, either by making a braided band and tying the ends, adding tassels of the same, or by using narrow ribbon for the band. Have the outside row double in thickness. Variety may be given to this lesson by encouraging pupils to make hats of various shapes, coloring them with aniline dyes.

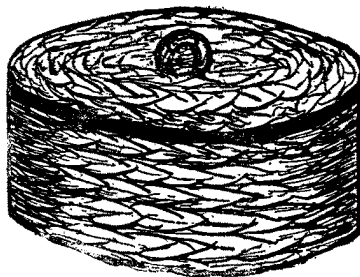

Model VII. Jewelry Box.

MODEL VII.—JEWELRY BOX.

If the edges are to be joined in sewing, the braid should be very heavy, so as to give solidity to the finished model. For bottom, make circular mat four inches in diameter. Add side to depth of two inches. For cover, make circular mat to fit, and hinge it to the box by sewing loosely, adding a loop on the opposite side of the cover, which may be fastened with a peg passing through a loop projecting from the front of the box.

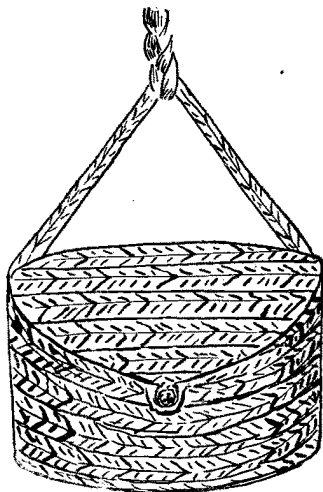

Model VIII. Handkerchief or Sewing Box.

MODEL VIII. — HANDKERCHIEF OR SEWING BOX.

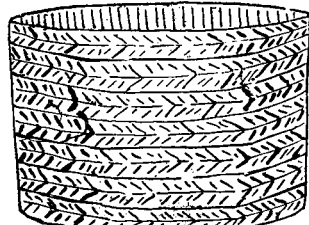
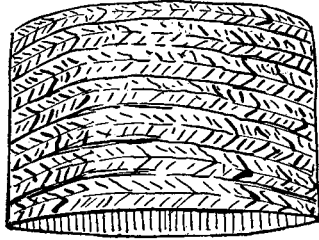

Model IX. Sewing Case.

For this model make the bottom five inches long and one inch wide and add side to the depth of four and a half inches. Then add the projecting piece for flap, placing a loop on the point which is to fasten over a button sewed to the bag. Add the braided chain for hanging, and after bending a double piece of stout wire into shape for a hook, cover it with the braided raphia by weaving back and forth.

MODEL IX. — SEWING CASE.

For this model two pockets are made, one with the bottom one and one-half inches wide, six inches long and sides four

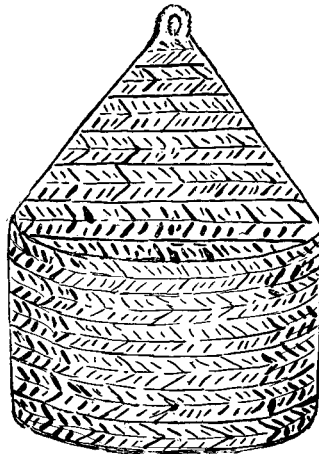

Model X. Letter Case.

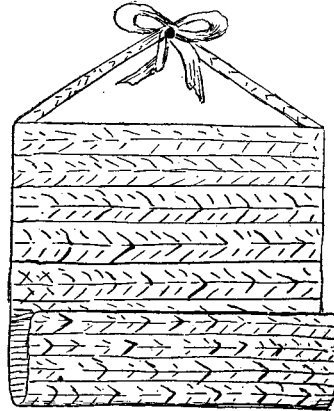

Model XI. Wall Pocket.

inches deep ; the other one enough larger to admit of its slipping down *outside* the smaller, thus forming a secure covering for the scissors, thread, etc., usually carried on a short journey.

MODEL X. — LETTER CASE.

Length of bottom, six inches. Width of bottom, one inch. Depth of side, three inches. Sew into shape and add back for hanging, as indicated in the illustration.

MODEL XI. — WALL POCKET.

Make oblong mat twelve inches long and eight inches wide; fold up one end so as to make the front of the pocket four inches deep. To each corner of this is fastened a braided strand two inches long, the other ends of which, being fastened to the back, hold the pocket in position. Add braided cord and tassels to the upper corners for hanging. This is very effective when made of coarse braid.

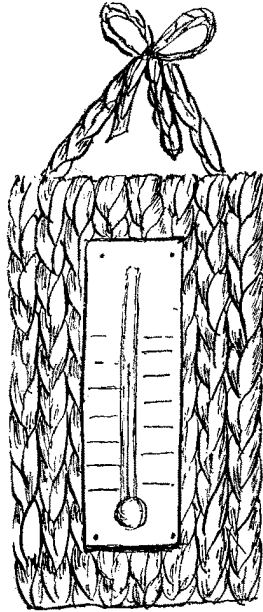

Model XII. Thermometer Back.

MODEL XII. — THERMOMETER
BACK.

Sew the braid to fit the thermometer, leaving a one-inch margin. Fasten a cord and tassel for hanging.

Nail the thermometer into position, using brass escutcheon pins and clinching the brads at the back.

MODEL XIII. — CALENDAR BACK.

Sew back to size for calendar, leaving suitable margin. Glue calendar to position.

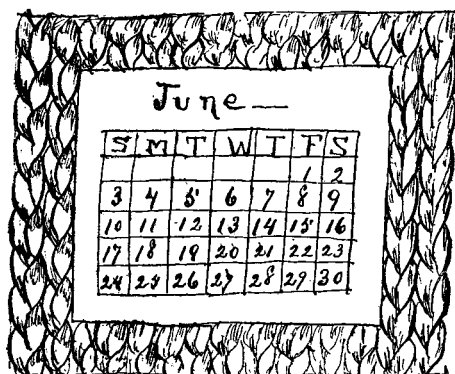

Model XIII. Calendar Back.

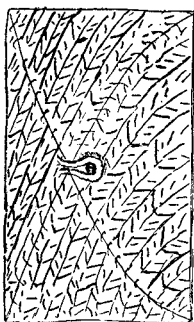

Model XIV. Handkerchief Case.

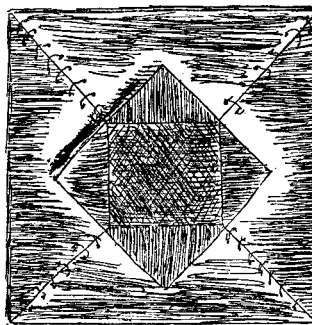

Model XV. Tray.

MODEL XIV. — HANDKERCHIEF CASE.

Make a braided square, eight by eight inches. Fold three of the corners to the center and sew to position. Place loop on the remaining corner, and sew a button to the case for fastening the flap in position.

MODEL XV. — TRAY.

Make a square eight by eight inches. Fold all corners to the center and then back again to the outside edge. Sew the edges together and fasten the corners down.

MODEL XVI.—SUNBONNET.

The braid of raphia used for the front of this model should be very firmly and finely woven, and in width be not more than one-eighth of an inch at the edge near the crown of the bonnet, and but a little wider at the front edge.

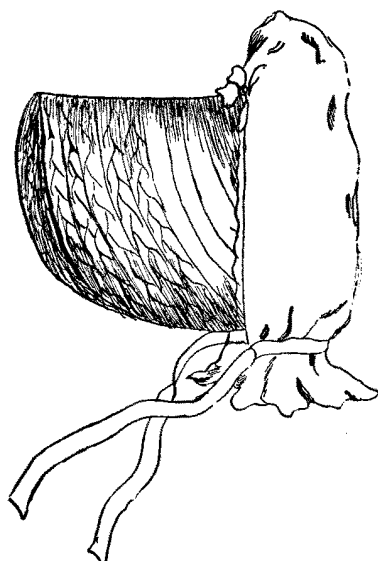

Model XVI. Sunbonnet

In sewing the braid into shape use *thread*, with a common sewing needle. The crown may be made of turkey red muslin, or of any color to suit the taste of the child making it. The front should be fitted to the doll's head. After sewing in the crown, add strings for tying, and a bow for the front of the crown.

MODEL XVII.—BOOK BAG.

Sew the braided raphia into an oblong piece fourteen inches long, five inches wide. Double the ends together, and join the edges by a raphia strand, braided and sewed on in zigzag fashion, leaving the sides open for about one inch, as shown in Fig. 1. Add the handles.

These bags may be made of different sizes, and used for various purposes.

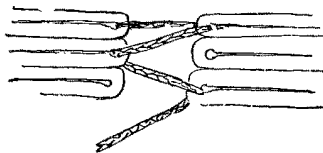
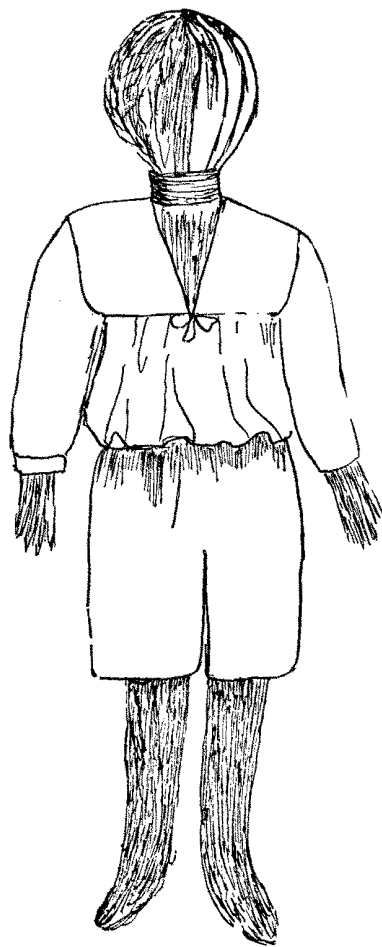

Fig. 1.

MODEL XVIII.—RAPHIA DOLLS. I.

After braiding a length of raphia, in thickness about the size of the little finger, cut it into pieces twice the length desired for the height of the doll. Lay these lengths side by side, and using a strand of raphia, tie them together around the middle. Now double them over at this point, and tie again, to form the head.



Model XVIII. Doll I.

From this point separate such portion as will be needed to form the arms, and after measuring off the waist line, tie here. Separate the strands to form the legs, and if more than one braided strand is needed to form the leg of the desired thickness, they may be bound together by winding round and round each leg a strand of raphia. Clothing may be fashioned from tissue paper, and the dolls dressed as boys or girls. Eyes, nose and mouth may be marked with ink.

MODEL XIX.—DOLL. II.

Many strands of raphia are laid side by side, on the desk, and then tied together around the middle. Double the



Model XIX. Raphia Doll.

strands over at this point, and tie another strand around these at the point where the neck is to be formed.

The size of the head thus formed will depend upon the number of strands of raphia used. From this point separate, at each side, enough strands to form the arms, and into this part insert fine bonnet wire, one piece for each arm (copper wire may be used), and plait, in a three strand braid, the portion set aside for the arms. From the remaining strands form the body, and tie again at the waist line, and then separate the strands into two equal parts. Now insert two pieces of wire, each as long as the doll from *head to toe*, passing the ends up into the *head*, and braid these strands to form the

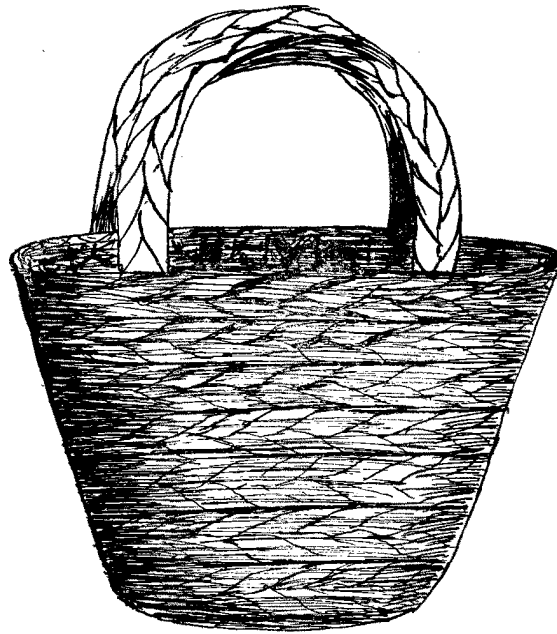

Model XX. Shopping Bag.

legs. The use of the wire permits the bending of the body. Three pieces may be inserted into each arm, and six pieces into the body. This will give more firmness to the braided strand.

MODEL XX.—SHOPPING BAG.

The making of this model is simplified by using a *form* over which it is shaped. To make this form, cut two pieces of heavy cardboard to the size and shape desired for the face of the bag. Place between these pieces enough paper or cotton to form the desired thickness, and wind around with cord. Having braided the raphia, sew together to form an oblong piece, fitting the bottom of the *form*. From the edges of this bottom piece form the sides of the bag, frequently placing the work over the form in order to secure the desired flare for the sides. Add the length for the handle, as indicated in the drawing.

RAPHIA WITH SLATS, WIRE, ETC.

Materials used.—Pith, raphia, slats, wire, long wire hair-pins, and brass rings of various sizes. Tools, one pair of flat pliers, one pair of wire cutters, and a quantity of coarse darning needles.

MODEL I.—MAT.

The slats used in this model are six inches long and one-half inch wide. Use four strips six inches, and one four inches in length. Place one above the other, with the shorter one *inside*, and fasten them together in the middle, using a slender brad or a large pin. This is to be removed when the mat is finished.

Now lay this foundation on the desk, and spread the rays equally apart. With the raphia weave over one, under one, until within one-half inch of the end of the slats, and finish the end by sewing it into the edge of the mat; notch the ends of the slats. A second one may be made by weaving the raphia to the ends of the slats, and then sewing the edge, as indicated at Fig. I. The ends of the slats are notched, and below this notch a hole is bored (see Fig. I.), through which the needle passes in sewing. Sew over and over, until the ends of the slats are covered.

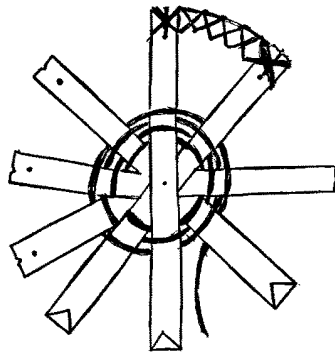

Fig. 1.

MODEL II. — BOOK MARKER.

For the foundation use kindergarten "pasting slats." These are ten inches long and one-quarter inch wide. Use two strips, cutting one into three equal pieces, and crossing as indicated at Fig. 2.

With a strand of raphia, begin at 1 and weave over 1, under 2, over 3, under 4, over 5, under 6, over 7, and here change and pass *under two* slats (Nos. 8 and 1); pass under two each time around but always make this change one slat ahead of the last change, *i. e.*, under 2 and 3, 4 and 5, etc.

This is necessary when using an even number of foundation rays. The work would be more simple if an uneven number were used, and these fastened together as in Model I. Finish off by notching the ends, and sewing the end of the raphia into the edge of the marker.

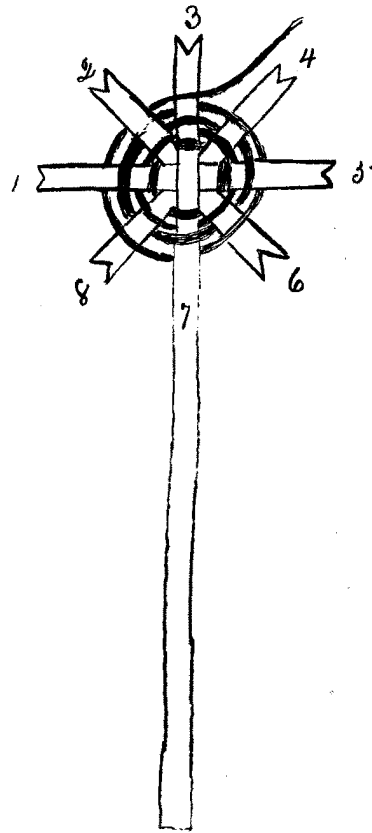

Fig. 2. Detail of Book Marker.

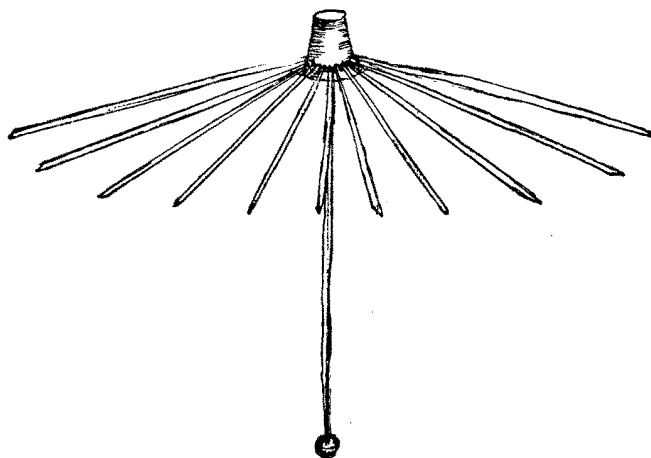

Fig. 3. Detail of Open Umbrella.

MODEL III. — UMBRELLA.

Material. — Corks (one inch long, one-half inch in diameter) ; toothpicks, beads and raphia.

Tools. — Brad awl, scissors and needles.

Place the small end of the cork on the desk, and with a coarse brad awl pierce holes around it about one-fourth inch from the end, being careful to insert the brad awl at an angle *outward*.

Into these holes are placed wooden toothpicks ; these are to form the ribs of the umbrella. It is now readily understood why the holes are to be at an angle. (So that the umbrella, when covered, will have the correct slope.) Cover this framework with strands of raphia, proceeding in the same manner as in *raphia and wire mat*. Fasten the end of the raphia by sewing it into the edge of the work and then slip a colored glass bead over the end of each *rib*. Insert another toothpick into the large end of the cork. This will form the handle. Slip a larger bead over the end of the handle to form the *knob*.

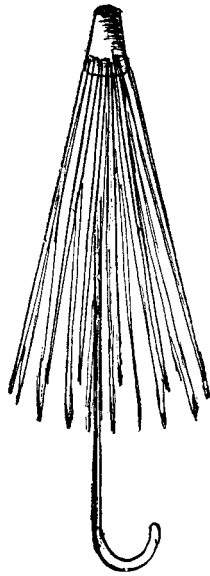

Fig. 4.
Detail—Umbrella, Closed.

MODEL IV.—UMBRELLA. (CLOSED.)

Materials.—Corks, raphia, wire hairpins and glass beads. Tools.—Needles, scissors, brad awl, and one pair combination pliers and wire cutters.

With the brad awl pierce holes in the cork, as in the preceding model, having the angle such that the framework will represent a partly closed umbrella.

Using the wire cutters, cut the hairpins into the lengths desired for the ribs, and insert into the holes the ends of these pieces, thus forming the framework.

Now cover this foundation with raphia, as in the preceding model. Insert another length for the handle, and with the pliers, shape the end into a *crook*.

MODEL V.—BASKET, WITH HANDLE.

Use for the framework seven pieces of pith, one-quarter inch wide and eight inches long, and one piece five inches long.

Place a dot at the middle of each eight-inch piece, and one inch from the end of the five-inch piece; fasten all together at this dot, using a fine brad, half-inch, No. 20. Lay this framework on the desk, and spread the rays to equal distances. Draw a line across the width of each, one and one-half inches from the center. With a single strand of raphia, proceed to weave over one, under one, until the pencil lines are reached.

With a sharp knife score these lines lightly, and from this point turn up the rays for the sides. For the weaver, we

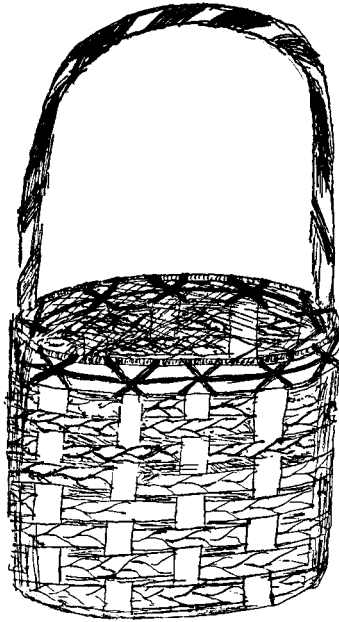

Fig. 5. Basket, with Handle.

now use a three-strand braid of raphia (*tightly* braided), and weave under and over until the sides are two inches deep; then fasten the end.

Take two strips of pith, each one long enough to pass around the basket, one outside, one inside, allowing for the lap. Holding one end of each in place, proceed to sew, crossing the threads at each spoke, and also passing it along from ray to ray, as shown in the drawing. Use a darning needle, with a strand of raphia for the thread.

For the handle, use a piece of pith, twelve inches long. Insert the ends well

into the sides of the basket, and, winding a strip of raphia back and forth, cover the pith. Fasten the handle firmly into the sides of the basket by sewing the raphia *across* and *through*, as when binding the top.

MODEL VI.—COVER FOR A DRINKING GLASS.

Having chosen a glass of suitable size and shape, use pith one-quarter inch wide for the foundation rays, and cut the pieces long enough to pass around the glass *lengthwise*. The number of pieces will vary according to the diameter of the bottom of the glass, but must always be an uneven number. Fasten all together as in the preceding model, and lay this foundation on the desk, with the rays spread equally.

Wet the raphia and weave with a single strand, over one, under one, to the width of the bottom. At this point, using a sharp knife, carefully split the rays, and if the spokes are still too far apart insert others at regular intervals, after pointing the ends. Now score the pith, crosswise, at point of

turning up for the sides, weave over and under until the required depth is reached, and then bind the top edge as in the preceding model.

Make the cover, in the same manner as the bottom, as large as the diameter of the top, and bind the edge, holding the pith against the *thickness* of the edge. Sew the cover into position and finish with a loop of elastic cord. Fasten a bead the size of a pea on the basket opposite the loop on the cover; for this use a fine brad and clinch it on the inside of the basket. The loop should be long enough to catch over the bead for fastening.

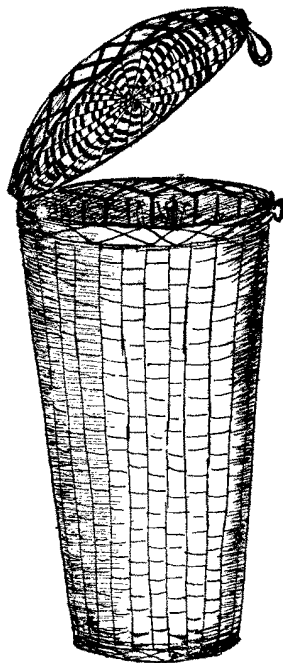

Model VI.
Cover for Drinking Glass.

MAT.

Circular and oval mats, trays, bowls and baskets, may be made by twisting many strands of raphia into a sort of rope, and then sewing this rope into shape, using the buttonhole stitch.

Taking as many single strands as will make a rope of sufficient thickness, wind these for about six inches, with a single strand of raphia.

Then, beginning at the twisted end, place it inside to form

the center of the mat. Now with a darning needle, threaded with a strand of dampened raphia, join the successive rows, as wound. See Fig. 7. Hold the loose ends *toward* the body.

In giving this work to very young children it will be necessary to wind the entire length of the *rope*, additional lengths being added by *splicing*. But for the older pupils, after the center is well started, it will not be necessary to wind further, as, with the left hand, the pupil can easily keep the *rope* in a sort of twist. Hold this twisted end close against the mat until fastened into place, and then twist another length and sew, and so on until the mat is the desired size.

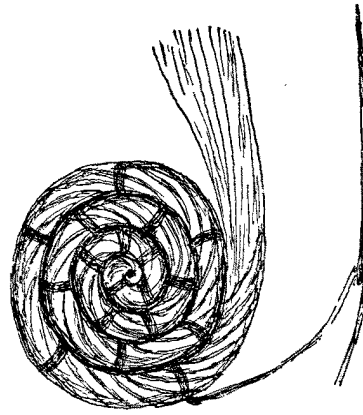

Fig. 7. Mat (made from twisted raphia).

BASKET.

Start with the twisted strand, as for the circular mat. Make the bottom of the basket three inches in diameter and then form the sides. Hold the *rope* so as to form a gradual

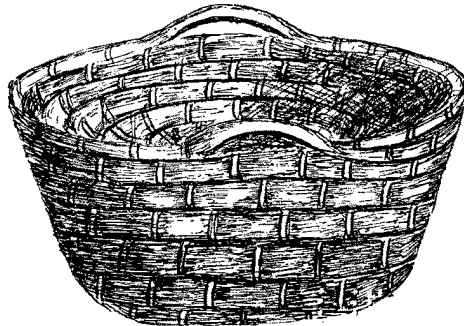

Fig. 8. Basket.

flare to the sides, and form the handle from the one piece—that is, the handles are not made *separate*. After both handles are formed, continue the sewing until the handle first formed is reached, and fasten the end here.

It will readily be seen that the *firmness* of the finished basket depends upon the *firmness* of the twisted *rope*. For large pieces it will be better to have the rope about three-fourths of an inch in diameter.

RUSH OR ROPE BASKET.

The basket shown in the illustration was made from rush which is found growing in marshy regions. Wire was used for the joining. A piece of No. 8 reed formed the handle. This was then covered with a twist of rush as shown.

As this material is not always readily obtained, a basket may be made from rope, using wire or stout cord for joining. Cut the rope into pieces twelve inches in length, and use two lengths of wire, each twenty-four inches long. Place one piece of rope on the desk and pass both pieces of wire around it and *cross* the ends of each, bringing the wire *close* to the rope, and each piece one and one-half inches away from the middle, thus leaving a space three inches between the wire. Now place the second piece of rope between the wires and again cross the ends and proceed until the last piece of rope is added, when the ends of the wire are twisted closely

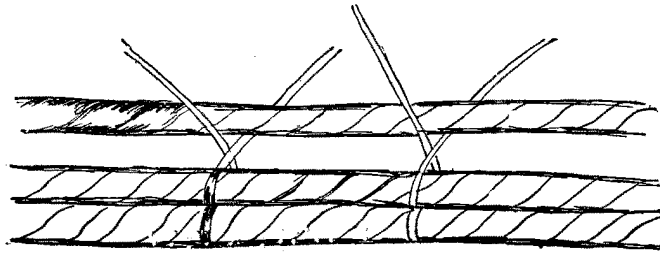

Detail of Rush Basket.

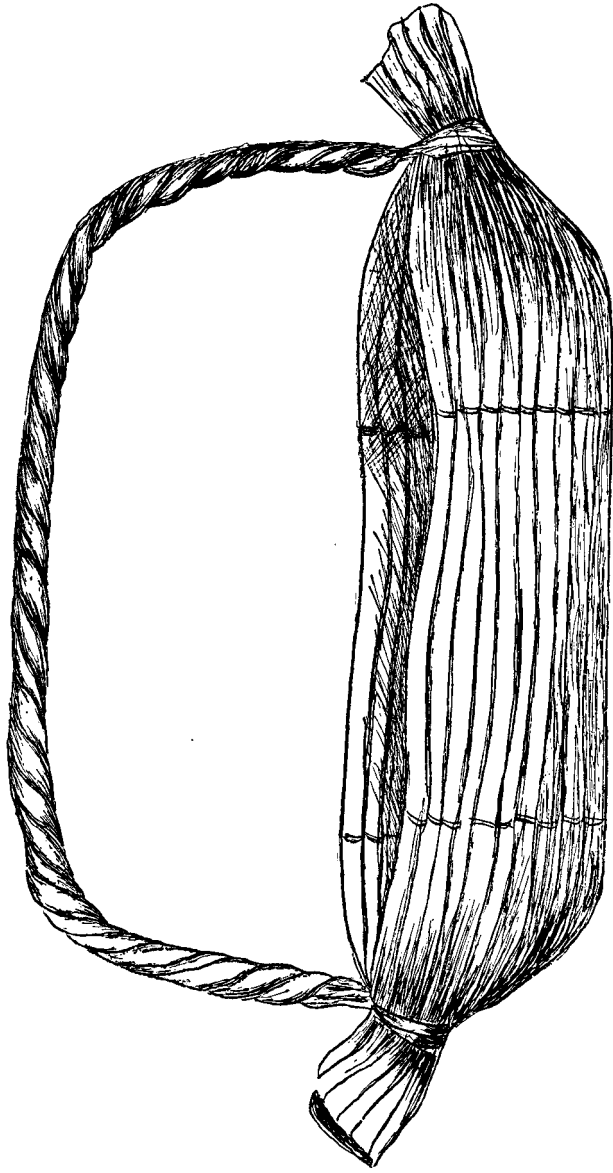

Model IX. Rush or Rope Basket.

and cut. The ends of the rope are now brought together and the basket formed into a boat shape. A wire is twisted around the ends to hold them firmly in position. The foundation for the handles is formed by a piece of reed (No. 8) fourteen inches in length. This is covered with a twist of rope which may be brought over the wire which binds the ends together. If stout cord is used for joining it will be necessary to tie it after each piece of rope is laid in place, as the cord will not hold the rope so firmly as the wire will.

Baskets of similar shape but larger size may be made from cornstalks when, of course, it would be better to use wire for joining.

CUFF AND COLLAR BOX.

Material.—Pith, one-quarter inch wide, and raphia. Dampen the pith, and form a circle five inches in diameter, from one end. The pith is now wound in a *spiral*, to form the sides of the box, which should be about five inches in height. The raphia is used for joining the pith, as shown in the illustration. It must be damp, and used with a coarse needle. The bottom of the box may be made of circles of thin wood, or of heavy cardboard, and in either case holes are bored near the edge of the circle, and this is sewed into the edge of the box.

For the edge of the cover, join, *separately*, two circles of pith, as in the sides of the box, and for the top of the cover use a circle of cardboard, covered with raphia. To cover this, cut a hole in the center, and work in buttonhole stitch

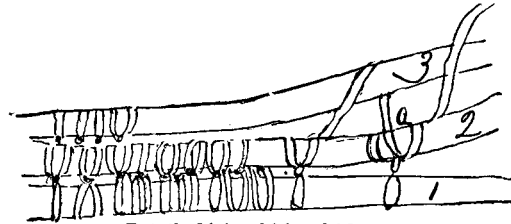

Detail of join of 2d and 3d rows.

around the outer edge, passing the thread through the hole in the center.

Join this covered piece to the edge of the cover, by sewing through the ridge formed by the buttonhole stitch. The bottom of the box will present a neater appearance if it is covered in the same manner. A ring is placed on the top of the cover. This is formed of tightly braided raphia, or by covering a small brass curtain ring with a buttonhole stitch, as in napkin ring.

After passing once around with the raphia, the thread is brought up *between 2 and 3, over 3*, and then down in *front of 2*, and between the *looped stitches*; it is then brought out between 2 and 3, and back over at A, forming a *knot*, and so on. This makes a very durable and effective join.

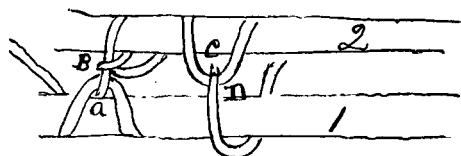

Detail of join of first two rows of side of Cuff Box.

Pass the raphia, with a buttonhole loop, over strip No. 1. Bring the end of the thread through this loop, and *over* strip

No. 2, then down behind No. 2, and back over the thread at B. Then carry it *back* of No. 2, and up over it, and here form another buttonhole stitch. Bring the end around No. 1, at D, and here form another loop, and proceed. It will be noticed that the loops alternate on either side.

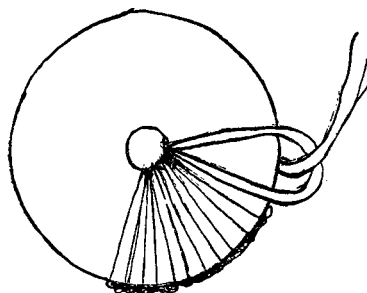

Detail of Top of Cover for Cuff Box.

FRAME.

From a square of cardboard cut a circular frame, using five and one-half inches for outside diameter and two inches for inside. Cover this with raphia, using the buttonhole stitch as in detail for cover of cuff and collar box. After the open framework is covered glue another circular piece to the back. Use braided raphia cord for hanging, or make an easel back.

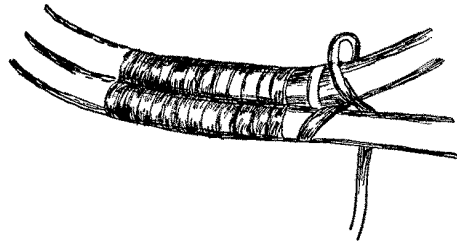

Detail of Rings.

RINGS.

Rings for various purposes may be made from pith, round or split reed. For napkin rings use the split reed (No. 8), or pith (No. 5). Make two rings of the *same* size and join the ends of each by lapping and wiring. The ends should be trimmed down with a sharp knife so that the join will be smooth. Now wet a strand of raphia and thread it through a coarse needle. Hold the two rings side by side and join them by passing the raphia *over* the under one, in *between* the two, *under* the top one, and then bring the end to the front and *over* the top one, in *between* the two, *behind* the lower one, back again to the front, in *between* the two and so on, being careful to lay the raphia on closely and evenly. This will make a very smooth covering.

Larger rings for use in "Ring Toss" or with "Grace hoops" may be made by using No. 8 (or heavier) round reed. Form into rings by splicing and wiring with fine wire.



They are covered with raphia in the same manner, but the appearance is made more pleasing to the child by coloring the raphia before using. This may easily be done by using "Diamond Dyes."

RAPHIA, with WIRE.

By using wire as a foundation, over which the raphia is woven, many artistic articles may be made. Copper wire, being very pliable, is often used when the pupils are too young to manipulate the heavier iron wire. In size it should not be too fine, that of the lead in an ordinary sized lead pencil being about right. The flat mat is chosen for the first lesson, and the wire, having been cut to an even number of

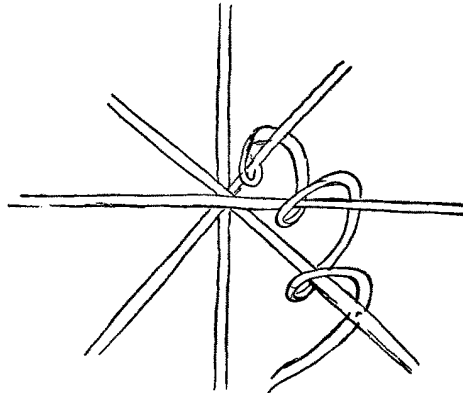

Detail of Raphia and Wire Mat.

desired lengths, is crossed at the center, and held between the thumb and forefinger of the left hand, while with the right hand, the strand of raphia is carried under *one* ray, brought up and carried back over the top of the same, and then across from the under



side to the next spoke, as shown in the detail. This throws the covered wire up on top, in the form of a ridge. When finished, the ends of the wire are bent over the mat, to prevent the raphia from slipping off. A fringe is added by looping doubled strands of raphia into the edge. Either side may be used for the top.

RAPHIA, WITH WIRE HAIRPINS.

By using heavy wire hairpins, substantial foundations for many pieces of dolls' furniture may be made. The hairpins

are firmer than the copper wire, and may easily be cut by using a pair of wire cutters, and bent into any desired shape with a pair of flat pliers.

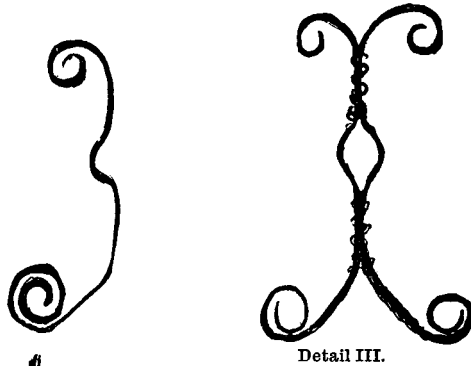

Detail III.

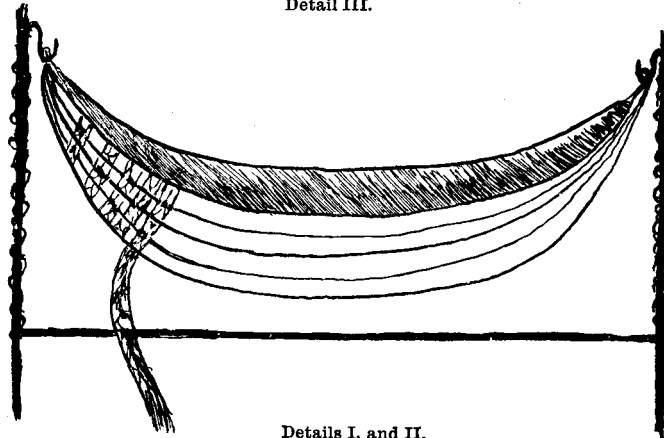

Details I. and II.

The different parts of the framework should be joined firmly by using fine wire, and after the foundation is secured it may be painted or not. If the entire framework is not painted, it will be necessary to wind, with raphia, the parts not covered by the weaving.

Tables (oblong, square or circular), chairs, of all styles, hanging baskets, basinet, etc., etc., may very easily be made.

BASINET.

In making the basinet, bend the hairpins for the ends, as in Detail I., using two hairpins for each end piece. After bending to desired shape, wire these pieces together with fine wire, and then wind with raphia.

Detail II. In order to strengthen the framework, a cross-piece is placed at the bottom, as seen in the drawing, and the ends are brought up to near the top of the uprights, and here bent down, so as to form a hook, on which the basket is hung.

Detail III. The framework for the basket is formed by using copper wire, and then covered with strands of braided raphia.

MATCH HOLDER.

Materials. — Raphia, wire brads (3 in., No. 14), small can of red "carriage paint," wood (pine or whitewood), 3 in. x 3 in. and ½ in. thick, ruler and compass. Find the center of the square of wood, and describe a circle two inches in diameter. Into this circle drive an uneven number of long, slender brads, being careful to have equal spaces between the

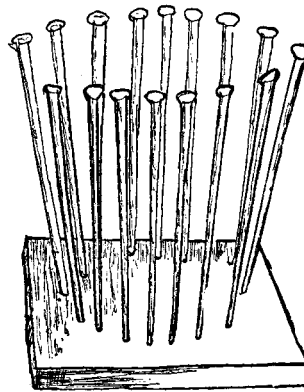

Fig. 10. Foundation for Match Holder

nails, and to stand them so that the heads point *out*, thus making the top larger than the bottom.

Now, with strands of raphia, weave under and over until the heads of the brads are reached, and here fasten the end by sewing it into the edge of the holder. While weaving, each additional strand needed is added by *splicing* (i. e., by placing the end of the new strand back alongside the end of the last strand), and *not* by tying. This model is made more attractive by painting the foundation before the raphia is woven in. In this case, the work cannot be completed in one lesson, as time must be given for the paint to harden.

Baskets of different sizes may be made by using larger squares of wood and brads of the same or longer lengths.

The appearance of the base is improved if the edge is *beveled*. To do this, draw a line on the face of the wood one-quarter inch from the edge, and lines on the edges one-eighth

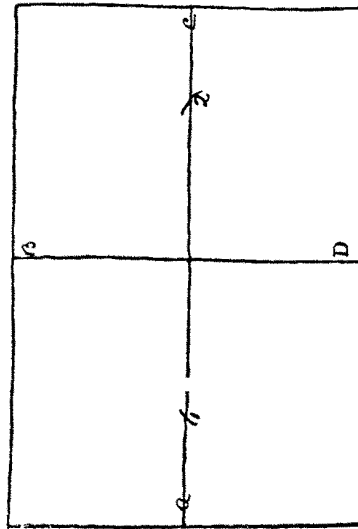

Fig. 11.

inch from this face.

Bevel to these lines, either by placing the wood in a vise and planing to these lines, or by using a knife. Cut the edges away to these lines. Finish to the lines with sandpaper.

ELLIPTICAL BASKET.

Materials. — Raphia, wire brads 3 in. long, and red paint; basswood, $\frac{3}{4}$ in. x $4\frac{1}{4}$ in. x $\frac{3}{8}$ in.

Tools. — Scissors, rule, compass, needle, knife, hammer, twine.

For the bottom of this

basket use basswood, $\frac{3}{8}$ in. thick, $6\frac{1}{4}$ in. long and $4\frac{1}{4}$ in. wide. Size of the ellipse to be 6 in. x 4 in.

Draw lines both lengthwise and crosswise the middle of the board. From the point of intersection of these lines, lay off, on the long diameter, three inches to the right and left, points A and C, and from the same point lay off two inches, above and below, points B and D on the short diameter.

We now have the length and width of the ellipse. Set the compass with a radius equal to one-half the long diameter (3 in.), and placing the needle point at point marked for outside limit of short diameter, describe arcs, cutting the long diameter at 1 and 2. See Fig. 11. Now place one-inch brads at points of intersection 1, 2, and at D. Tie a piece of stout thread around the brads, slipping it down close to the wood. Now remove the brad at D, and place a pencil at this place, and move it around on the wood, keeping the point close to the string, and so describe the ellipse. Now cut to this line, using a sharp knife. Draw another line around the ellipse,

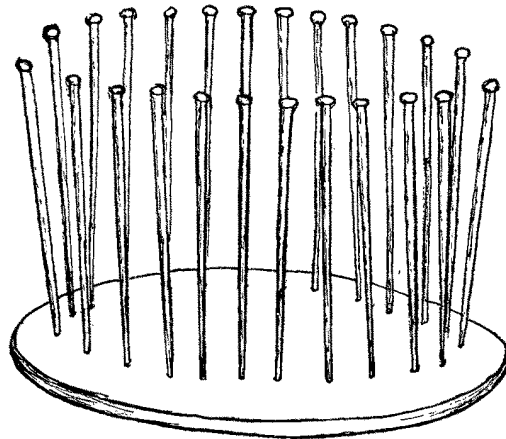

Fig. 12. Elliptical Framework for Basket.

one-half inch from the edge, and into this line, at every half inch, drive wire brads, three inches long, or longer, if desired. Paint this foundation with red or blue carriage paint, and set aside for twenty-four hours.

Braid raphia into a *fine* and *close* strand, and weave around these brads, as in match holder.

NAPKIN RING.

Take ten brass curtain rings about one inch in diameter, and cover each one of these rings with raphia, worked on in buttonhole stitch. See Figs. 13 and 14. No needle is needed,

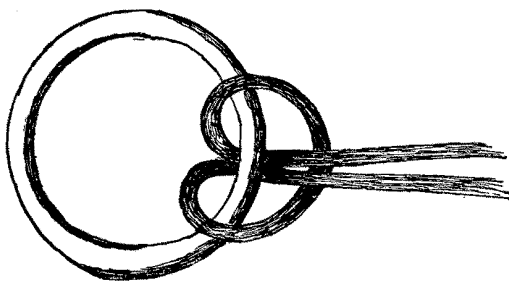

Fig. 13. Detail of Covered Ring.

as this can easily be done with the fingers. After the ten rings are covered, join these by lapping, as in Fig. 15, and passing a ribbon (one inch wide), *up* through the ring at A, and *down* through B, *up* through C, and *down* through D,

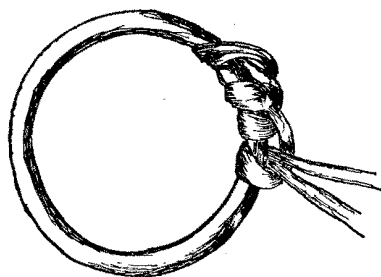

Fig. 14. Detail of Covered Ring.

and so on, until all have been joined, when the ends of the ribbons are to be tied in a double bow. Other sizes of rings may be covered, according to the width desired for the napkin ring, or the width may be formed

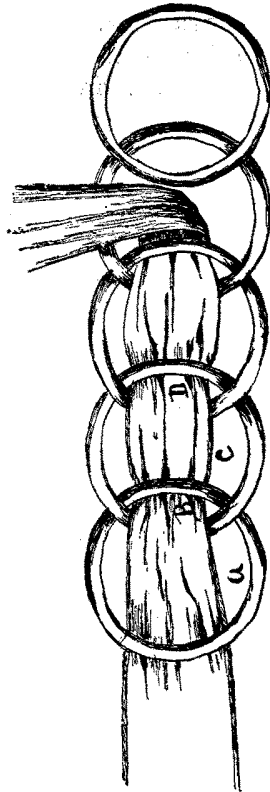

Fig. 15. Detail of Napkin Ring.

by sewing together two or more of the covered rings, and then joining, to form the length, by running a ribbon through each row, lengthwise, as when forming the ring one row wide.

Instead of ribbon, a five-strand braid of raphia may be used for joining. This is plaited, as in Fig. 16.

HOLDER FOR BURNT MATCHES.

Having obtained a glass of suitable size and shape take as many brass curtain rings one inch in diameter as will pass around the glass, after being overlapped as in Detail No. IV. for the napkin ring. Cover the rings as in Detail Nos. VII and II. for the same model. After having plaited a five-strand braid of raphia pass it through these rings, as in Detail III., and suspend by a long loop of the same.

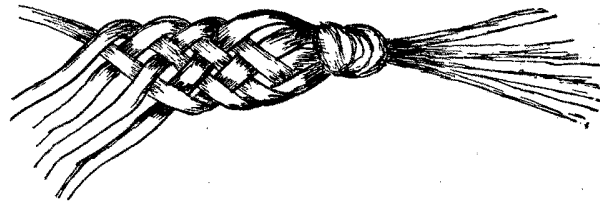
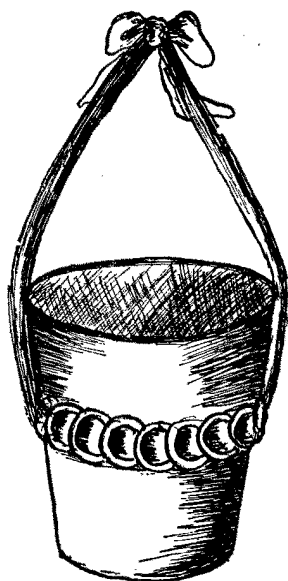

Fig. 16. Detail of Five-Strand Plait.



Model XVII.
Holder for Burnt Matches.

LETTER CASE.

For the foundation of this useful model obtain a wire *sponge basket*; (a single one costs five cents). After covering the loop woven on in buttonhole stitch, wind the wire reaching from the loop to the back of the basket, and cover in this same manner the top edge of the rack. It will be necessary to cross the strand of raphia at the point where each upright wire joins the top edge. This is necessary in order that all the wire may be hidden. Cover, also, the wire forming the lower edge and then, with a strand of wet raphia, begin at the lower ends of the upright wire and proceed to weave the raphia around the

framework. Do this in the same manner as in covering the wire foundation for the circular mat. This may be woven so as to throw the ridge on either side, as desired. Trays for the dresser may be made from wire soap dishes, and by covering the wire holders used for ginger ale bottles, and placing a glass inside, very pretty vases may be made.

KNOT WORK.

The following simple exercises are made in chain stitch, with the fingers, without the aid of a crochet-hook:

HORSE REINS.

Use a piece of soft twisted cotton twine and in length three times that desired for the finished work, i. e., four and one-half yards of twine for a finished length of one and one-half yards. Begin by forming a loop in one end by knot-

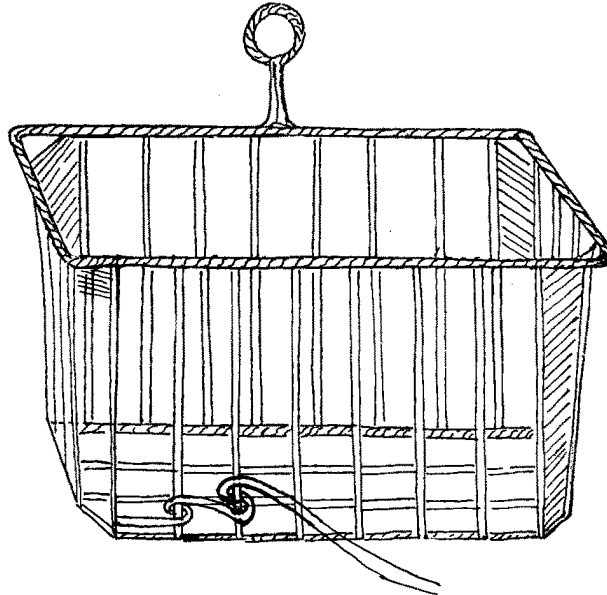

Fig. 18. Wire Foundation for Letter Case.

ting. Hold this knot between the thumb and finger of the left hand and use the right hand to pull the twine up through this loop, carefully keeping the free end toward the right hand.

Tighten or shorten this loop by pulling on the side toward the knot. This forms the chain stitch. Continue to the end, being careful to have the work uniform in thickness throughout the entire length. The cross-piece is made separate, and to this the bells are fastened. String the bells to this piece by passing a finer cord in and out the meshes and through the bells at the point where they are to be fastened to the cross-piece, and then on to the end.

The ends of the piece used for stringing are to be fastened into the main one, together with the loose ends of the cross-piece. These ends are woven in and out and then fastened down by using a needle and strong thread.

WHISTLE CHAIN.

For this exercise use No. 20 twine. Knot for the loop so as to leave the short end about three inches long. Proceed as for the reins, and when the chain is of the desired length, finish by working a chain stitch down the length of the short end, and to this fasten the whistle.

CHAIN FOR SCISSORS.

A chain for hanging scissors may be made in the same manner as the whistle chain or by plaiting a three-strand braid with double or triple strings, care being taken to keep the strings perfectly flat while working. This plait may be used by itself and the scissors fastened to the end, or by using brass curtain rings it can be made the same as napkin ring. (See raphia work.)

MINNOW NET.

For the framework use a piece of round reed six feet in length. Double this, and at the doubled end form a hoop by winding the remaining ends firmly together, using cotton twine, No. 60. This will form the handle. For a net one foot deep, cut the twine into four-foot lengths. Double these pieces and passing the loop up and through the hoop, bring it over to the outside and pass the ends through. Loop on the remaining lengths, leaving not more than one inch space between each piece. Beginning at any spot, take an end from each adjoining pair and tie a simple knot. Continue around the hoop in this manner. Then begin on the next row, and so on, until you have the net ready to shape the bottom for finishing. Now knot the strings a little closer together, and cut off one string from every fifth pair. Continue to knot as before until you come to the fifth one, and here take a string from each side of the single one and knot these two together with the single one and then cut off the single string. Continue in the same manner with the remaining ones, cutting more frequently, until the bottom is the requisite shape.