

MANUSCRIPT
 NOTES
 WEAVING
 FOR
 SECOND AND THIRD
 YEAR

BY - JAMES HOLMES

1ST CLASS HONOURS IN -
 COTTON MANUFACTURE,
 SPINNING & WEAVING.
 ORIGINAL DRAWINGS
 AND DESIGNS ETC, BY
 JAMES HOLMES JUNR,
 1ST CLASS HONOURS IN
 COTTON WEAVING
 SECTIONS - A & B. ALSO -
 1ST CLASS HONOURS IN
 SPINNING.

REGISTERED
 TEACHERS -
 CITY &
 GUILDS
 OF
 LONDON
 INSTITUTES.

FOREWORD.

The object in writing this book is to place before the student and the practical man in as brief a manner as possible, the essential points in the structure of various fabrics and the special machinery required to produce them. Principles are explained, rather than giving long descriptions, and, with the many illustrations which are given and which have been taken from actual machinery and cloth samples, it is hoped that the book will be of some little service. Many opportunities are now offered to students to study the subject of Cotton Weaving and to sketch and understand the machinery and also to carry out their own ideas in designing and weaving samples of cloth in the Technical Schools of the Country. Many of the drawings in this book are made from the machinery in the Technical Schools of Burnley and Nelson.

Many of the designs are such as can be carried out by a student, even though the loom may not be specially built for the type of cloth it is the intention of the student to weave.

The student in order to obtain the greatest benefit from a study of this book, must neatly and accurately make all the sketches either from the illustrations or whenever possible from the machines, must analyse the samples of cloths described for the weave and cloth structure and whenever an opportunity occurs must endeavour to weave sample of cloth involving the same principles.

Holme Lea
Burnley.

James Holmes
James Holmes Jr.

INDEX.

| | PAGES. |
|--|-----------------|
| Alhambra Quilting. | 96. |
| Automatic looms. | 133. |
| Bannister or Split harness. | 44. |
| Brocades. | 40. |
| Brocades, two or more wefts. | 110. |
| Card cutting machine. | 23. |
| CardACING by hand and machine. | 24. |
| Card Repeating machines. | 25. 27. |
| Card saving and Reversing motions. Box looms. | 106. 107. |
| Carpets. | 122. |
| Casting out. | 38. |
| Cylinder motions, card to serve for several picks. | 50. |
| Centre Shed Jacquard. | 20. |
| Centre Weft fork. | 108. 109. |
| Circular Box loom. | 71. 72. 73. |
| Cross Border Dobby. | 124. |
| Cross Border Jacquard. | 14. |
| Demasks. | 39. |
| Design or Point paper, various ruling. | 37. 38. |
| Diapers. | 39. |
| Double cloth. | 64. 65. 66. 67. |
| Double plain cloth. Jacquard and designs. | 69. |
| Drop Box motion, Bowburn or Pecks. | 62. 63. |
| Figured Repps, Jacquard and designs. | 94. 95. |
| Jacquard, card stop motion. | 11. |
| Jacquard, Card reversing motion. | 9. 11. |
| Jacquard for weaving Tilet cloths. | 60. |
| Jacquard, harness building. | 52. 53. |
| Jacquard machine. | 1. 2. 3. |
| Knowles chain. Drop Skip box motion. | 104. 105. |

| | | |
|--|--------|------------|
| Lappets. | Pages. | 129. |
| Leno Weaving. | | 72 to 79. |
| Lenos. Special effects. | | 86. 87. |
| Leno Jacquard with designs. | | 84. 85. |
| Madras Muslins. | | 88. 89. |
| Machine lift. Jacquard. | | 48. |
| Northrop loom. | | 133. |
| Novelty effects in weaving. | | 138. |
| Open Shed Jacquard. | | 18. |
| Patent Satin Quilting with Jacquard & Designs. | | 92. 93. |
| Pick and Pick motions. | | 90 91 |
| Piques. | | 56 to 60 |
| Pressure harness. | | 44. |
| Pressure harness. Jacquard and designs | | 44. |
| his shuttles Drop box motion. | | 102. 103. |
| Split harness. Jacquards and designs. | | 45 |
| Swivel Weaving. | | 125 |
| Tackling Jacquards. | | 35 |
| Terry Weaving. | | 113 |
| Tie-ups. Jacquards. | | 28 |
| Toilet Jacquard. | | 61. 62 |
| Tuck Weaving. | | 140 |
| Twilling Jacquard. | | 49 |
| Two cylinder Jacquard | | 10. 11 |
| Two warp & two weft Tapestries with designs. | | 98 to 101. |
| Warp let-off motions. | | 134. |
| Warp hile, arrangement of warps and Jacquard. | | 121. |
| Warp and weft backed cloths. | | 54. 55. |
| Warp pile fabrics. Figured velvets. | | 111. 112. |
| Warp Stop motions. | | 136. |
| Weft Tapestries. | | 94. |

The Jacquard Machine.

1

This is a machine used in weaving for the making of patterns which are too complicated for the Dobby. It is claimed to have been the invention of a Frenchman named Jacquard, but a careful study of the machines in use before his time, leads one to the conclusion that many of the ideas embodied in the Jacquard were in use before 1801, the year which is claimed as the birth year of the Jacquard machine.

In 1725 M. Bonchon employed a band of pierced paper, which was pressed against a number of needles, these needles controlled the threads of the warp, the blanks and perforations in the paper selecting the threads to be lifted in the production of the pattern.

In 1728 M. Falcon used paper cards for the purpose of selecting the threads of warp, these cards were laced together to form an endless chain and were passed over a square cylinder, and each card in its turn brought to the needle points, the cylinder was placed at the side, and the tail cords of the Draw-boy were the cords to which the hooks were attached.

In 1745 Vaucanson dispensed with the tail cords of the Draw-boy and placed the machine on the top of the loom where its action became more direct.

A short history of the life of Jacquard may not be out of place. Joseph Maria Jacquard was born of humble parents at Lyons (France) July 7th 1752 and was employed by his father who was a hand loom weaver, for we learn that on the death of his father he fell heir to two looms, but these were sacrificed to the inventive pursuits of the owner. In 1801 a medal was awarded him for an invention which he exhibited in Paris, whereby one workman per loom was superseded in weaving figured silks. Jacquard was summoned to Paris and after

²
interviews with Napoleon and Carnot he was attached to the Conservatoire des Arts et M^{ét}iers. A loom of Vaucanson's deposition has suggested improvements in his own, which he gradually brought to a final stage. In 1804 he returned to Lyons and although his invention was fiercely opposed by the silk weavers, whom it threatened to deprive of a livelihood, its advantages were too great to suffer resistance. Many years before his death which occurred at Oullins, a village near Lyons he had the satisfaction of seeing his loom in almost universal use and as a consequence, the prosperity of his native city rapidly advancing. Jacquard was rewarded with a pension of £60, a royalty of £2 upon each loom erected, and a cross of the Legion of Honour. His statue was erected in Lyons in 1840, on the spot where his loom had previously been publicly burned. Encyclopedia Britannica
Power loom jacquards are fixed above the loom on a suitable gantry erected for the purpose. Fig 1 illustrates the best method of mounting a jacquard, and is the system followed in the weaving shed of the Burnley Municipal Technical School, and is the work of Messrs G. Nutter & Co Burnley. The sketch being a photograph of a loom in the above school, and made by Messrs George Keighley Ltd. Burnley. on which is mounted a 200 double lift, one cylinder jacquard made by Messrs Devoge & Co. Manchester. The gantry is suspended from the gutter beams by the tie rods 1 and 1', the lower ends terminating in iron shoes 2, 2' which grip the gantry rails; fixed to the rails are adjustable feet 3, 3', on to which the jacquard feet rest and are secured by bolts, this arrangement offers a very ready or convenient method of raising and lowering the machines. The lifting levers bracket 4 is secured to the top of the jacquard, and is further supported by a rod 5, the lower end of which is secured to a cross bar 6 which is secured to and extends across the rails.

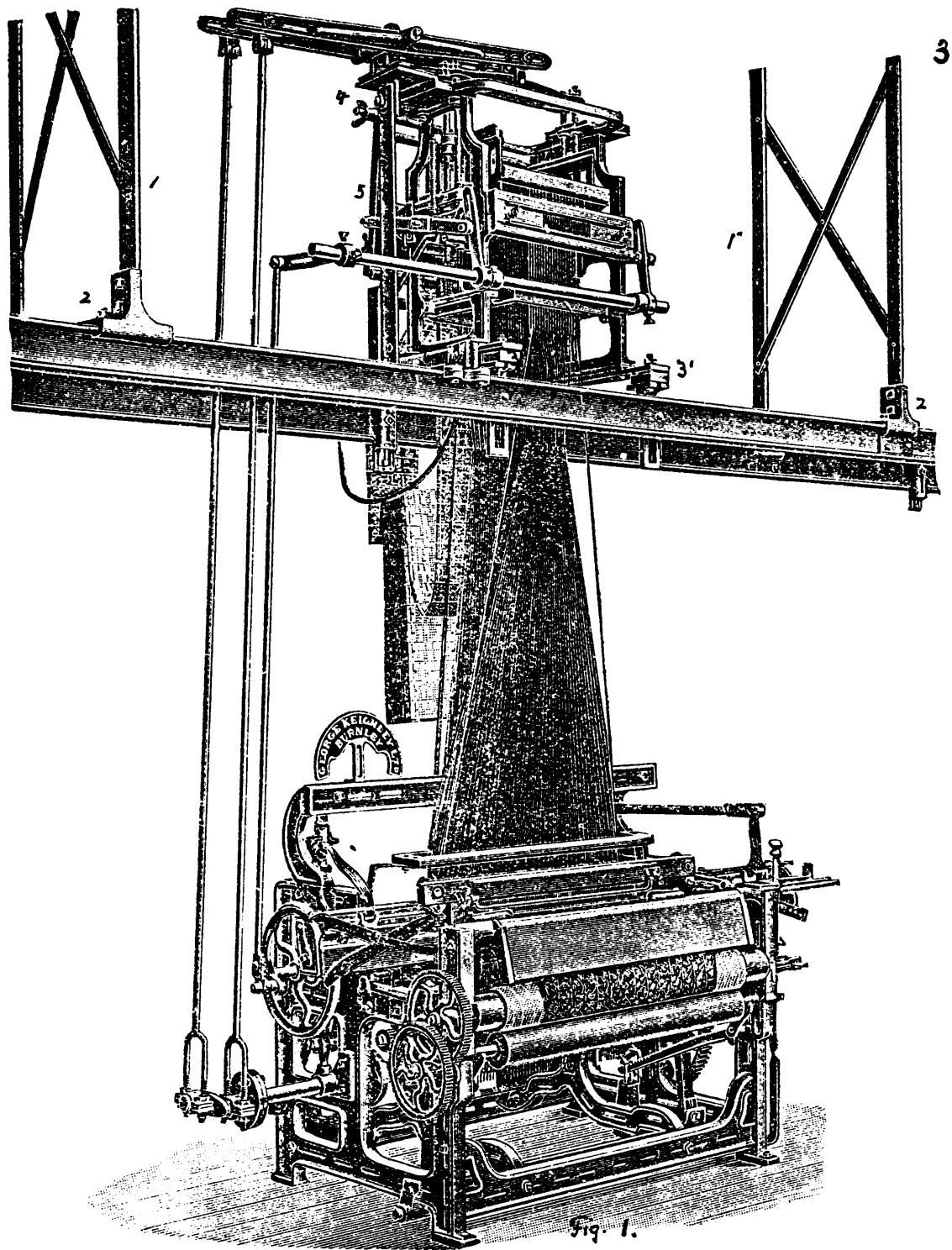

3
interviews with Napoleon and Carnot he was attached to the Conservatoire des Arts et Métiers. A loom of Vaucansons deposition has suggested improvements in his own, which he gradually brought to a final stage. In 1804 he returned to Lyons and although his invention was fiercely opposed by the silk weavers, whom it threatened to deprive of a livelihood, its advantages were too great to suffer resistance. Many years before his death which occurred at Oullins, a village near Lyons he had the satisfaction of seeing his loom in almost universal use and as a consequence, the prosperity of his native city rapidly advancing. Jacquard was rewarded with a pension of £60, a royalty of £2 upon each loom erected, and a cross of the Legion of Honour. His statue was erected in Lyons in 1840, on the spot where his loom had previously been publicly burned. Encyclopedia Britannica Power loom jacquards are fixed above the loom on a suitable gantry erected for the purpose. Fig 1 illustrates the best method of mounting a jacquard, and is the system followed in the weaving shed of the Burnley Municipal Technical School, and is the work of Messrs G. Nutter & Co Burnley. The sketch being a photograph of a loom in the above school, and made by Messrs George Keighley Ltd. Burnley. on which is mounted a 200 double lift, one cylinder jacquard made by Messrs Devoge & Co. Manchester. The gantry is suspended from the gutter beams by the tie rods 1 and 1', the lower ends terminating in iron shoes 2. 2' which grip the gantry rails; fixed to the rails are adjustable feet 3. 3', on to which the jacquard feet rest and are secured by bolts, this arrangement offers a very ready or convenient method of raising and lowering the machine. The lifting levers bracket 4 is secured to the top of the jacquard, and is further supported by a rod 5, the lower end of which is secured to a cross bar 6 which is secured to and extends across the rails.

4- Jacquards are made in different sizes from 100 to 600 hoots, perhaps the most common being the 400 machine. on a machine of this type a hatter can be woven which will repeat on 400 ends, on in other words its capacity is equal to 400 separate healds.

The principle of its construction is very simple and can readily understood by the examination of one needle and one hook.

Fig. 2 illustrates all that is required, the needle consists of a piece of bent wire with a loop at 1 the end 2 passes through a perforated needle board 3, pressing against the looped end is a spiral spring 4, the hook 5 which is controlled by the needle is turned over at the top and bottom, the lower part rests upon the bottom board 6, attached to the bottom of the hook is the neck cord 7, and to the neck cord is tied or looped the harness 8, this passes through the perforated comber board 9, a few inches below the comber board is the mail eye 10 through which the thread of warp is drawn;

attached to the lower end of the harness is the knigo 11, for self weighting purposes, the gaffe 12 consists of a number of thin blades of metal fixed to a frame which is raised and lowered on each pick, when the gaffe is at the bottom these blades are about a quarter of an inch below the top of the turned over portion of the hook, when the gaffe ascends it takes up the hooks along with it unless the same are purposely pushed out of the way, if the needle and consequently the hook is pushed back, the hook is left down and also the thread actuated by that hook.

Fig. 3 illustrates the hooks, needles, harness, comber board and tie-up of a 200 Jacquard, the needles and hooks are arranged in rows of eights and the comber board is bored in holes to correspond, the cards are behind the loom; the top needle of the first row works the hook with harness attached which passes through the back hole of the first row of holes in the comber board, the second needle works the next hook with harness attached

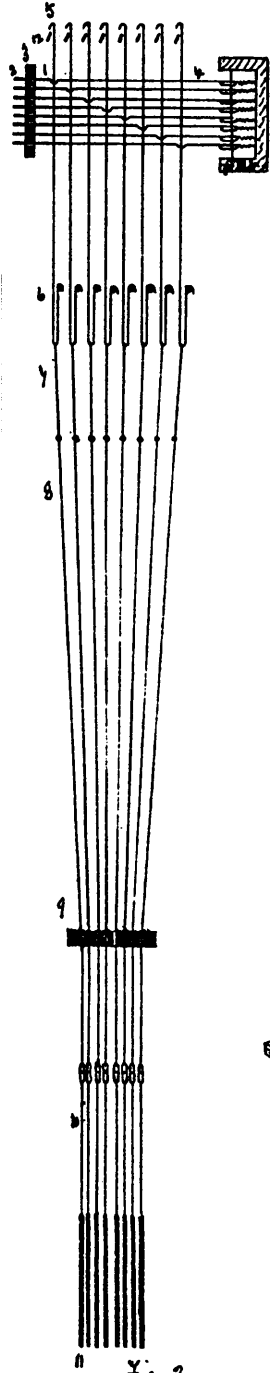

Fig. 2.

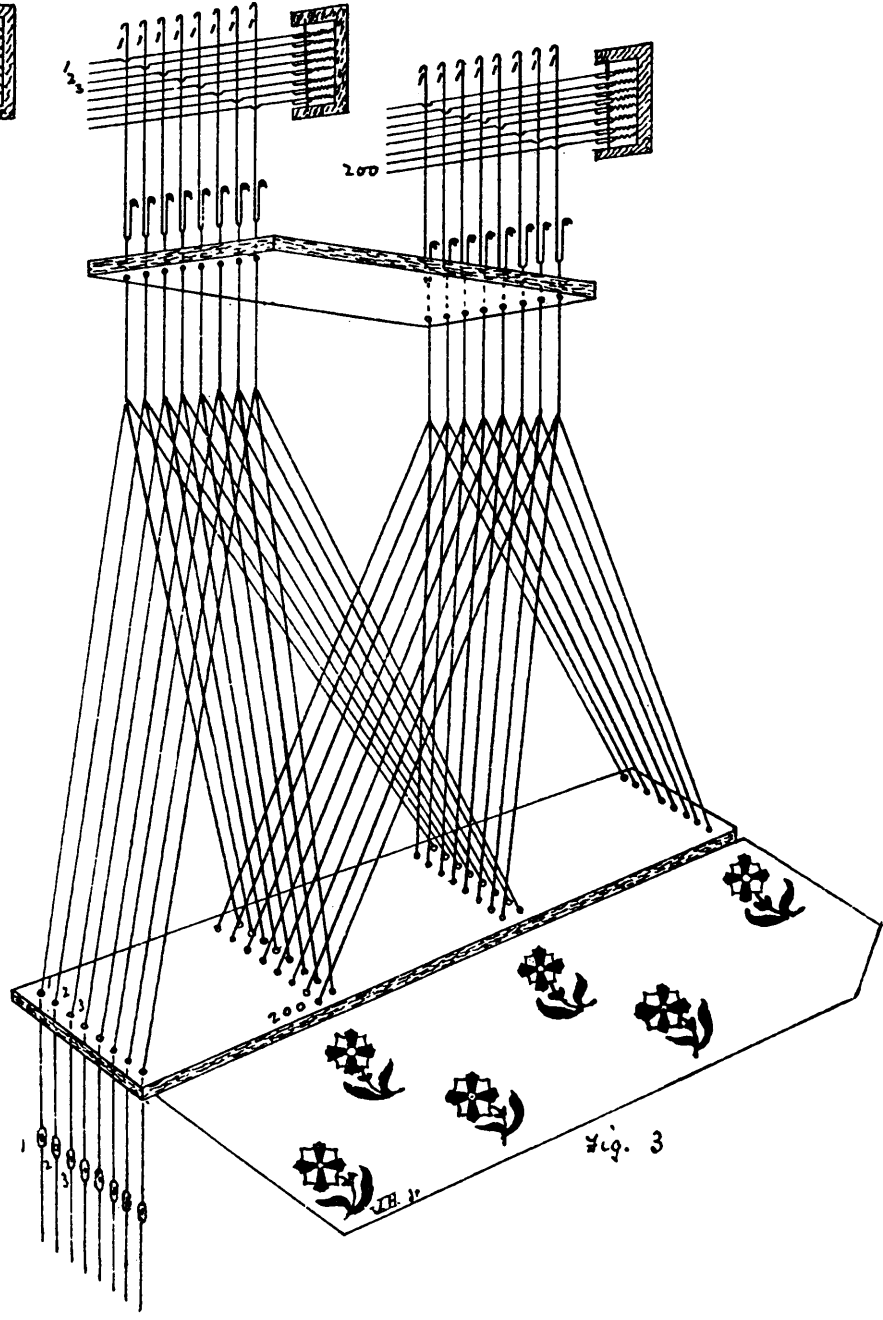
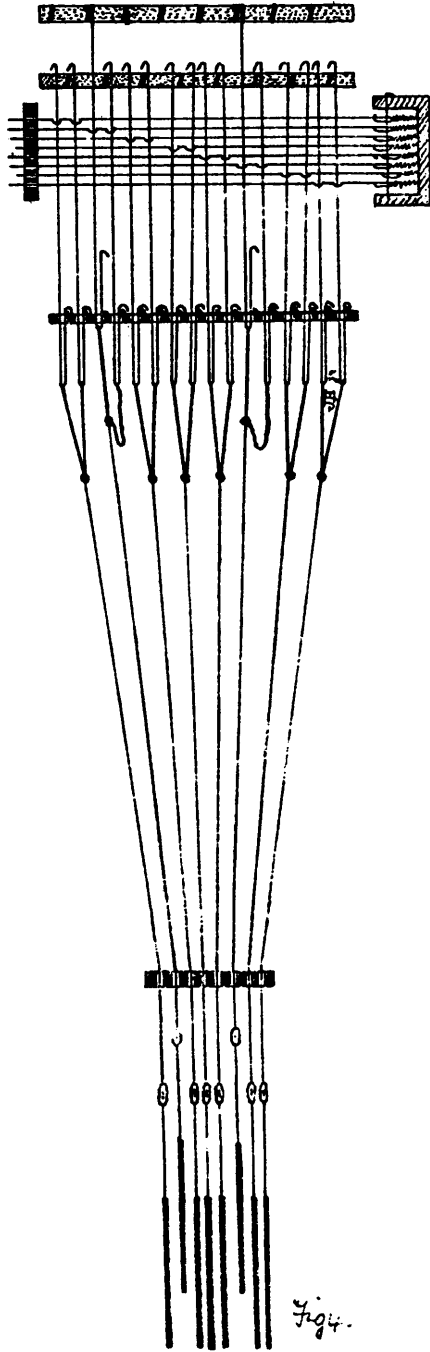

Fig. 3

6 passing through the second hole from the back, the rows of needles corresponding with the rows of the holes in the comb board, between the first row and the last there are twenty five rows of needles and hooks, also twenty five rows of holes in the comb board, between the first row and the last, the back hole of any row corresponding with the top needle of the same row of needles, in the last row shown in the fig. the top needle works the hook with harness attached, passing through the back hole of the 25th row of holes in the comb board; with one harness to each hook a cloth of 200 ends or one repeat will be woven; if a warp contains 2000 ends, 10 harness cords will be tied to each hook, these cords pass through their respective holes of the comb board and the pattern is 10 times repeated in the width of the cloth.

In getting up a new jacquard and drawing the ends through the harness for the first time commence at the left hand with the harness passing through the back hole of the first row of holes in the comb board and work to the right, then commence with the back hole of the second row. if tied up different to what is shown in fig. 3, then commence with the mail eye worked by the first hook of the machine, and this is generally worked by the top needle of the first row on the pulling over catch side of the cylinder.

Fig 4. shows the arrangement of needles and hooks in a Double lift single cylinder jacquard one needle works two hooks and either of the hooks can lift the same warp end, there are two lifting grippers and two of the hooks are shown lifted also two needles are shown working two hooks of the bottom gripper. The following show detail parts of a jacquard Fig 5. Cylinder. 6 end view of cylinder. 7 Section of cylinder. 8 Regulating brackets for raising or lowering the cylinder. 9 holding brackets for the cylinder and regulating screws for longitudinal adjustment.



γ

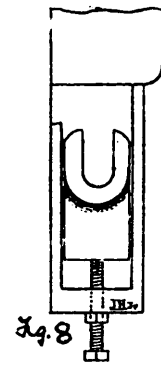
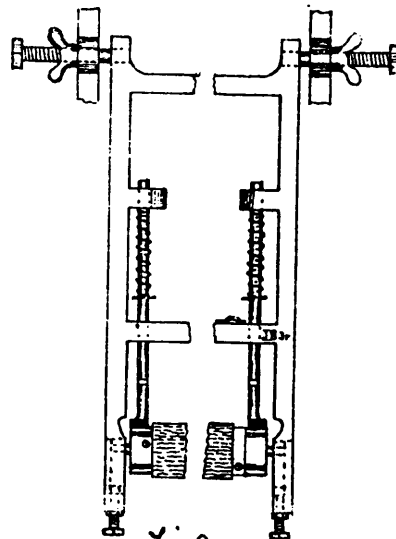
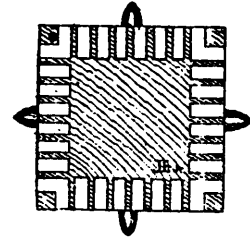
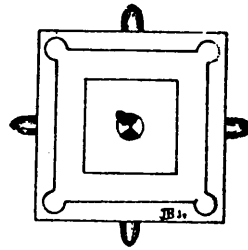
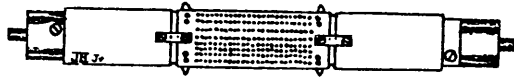

3 Double Lift, Sliding Cylinder, 400 Jacquard.

Fig. 10 illustrates the working of the giffes and cylinder of a single cylinder machine.

1, is the supporting gantry for the Jacquard with adjustable brackets 2 for raising and lowering the machine. The giffe supporting bracket is fixed to the cross rail 4, which in turn is fixed to the gantry. The two giffes 5 and 6 are moved up and down by the two levers 7 and 8, (the fulcrum being at 9) worked from a double crank 10 fixed on the end of the bottom shaft 11 of the loom, with the parts of the machine in the position shown, the cylinder is close to the needles and the card of the hatterre is making a selection of hooks for giffe 6.

The cylinder 12 receives a horizontal sliding motion through the straight rod 13 and the bell crank lever 14 and 15, working on the fulcrum 16; the end of the lever 15 is connected by means of an adjustable rod 17 to an eccentric 18 fixed on the crank shaft 19 of the loom. The advantages that are claimed for the sliding cylinder are, that it brings the card perfectly square to the needle points and consequently a less liability for cards to mislift. The spiral springs 20 are threaded on short spindles and supporting a small cross piece which constantly presses against the end of the cylinder and steadies it when turning and also prevents it turning too far. 21 and 22 are guide rollers for the cards and 23 the cradle for holding the cards when working. 24 the turning catch for revolving cylinder the cylinder and bringing another card into position as the cylinder moves out; a clearance between the catch and the cylinder must be allowed, just sufficient to turn the cylinder. 25, 26, 27, 28 and 29 illustrate the reversing of the cylinder to turn back cards to find a broken pick, the downward pull of 29 causes the end of 25 to push against the corner of the cylinder and reverse it. Points of adjustment for different purposes are marked A.

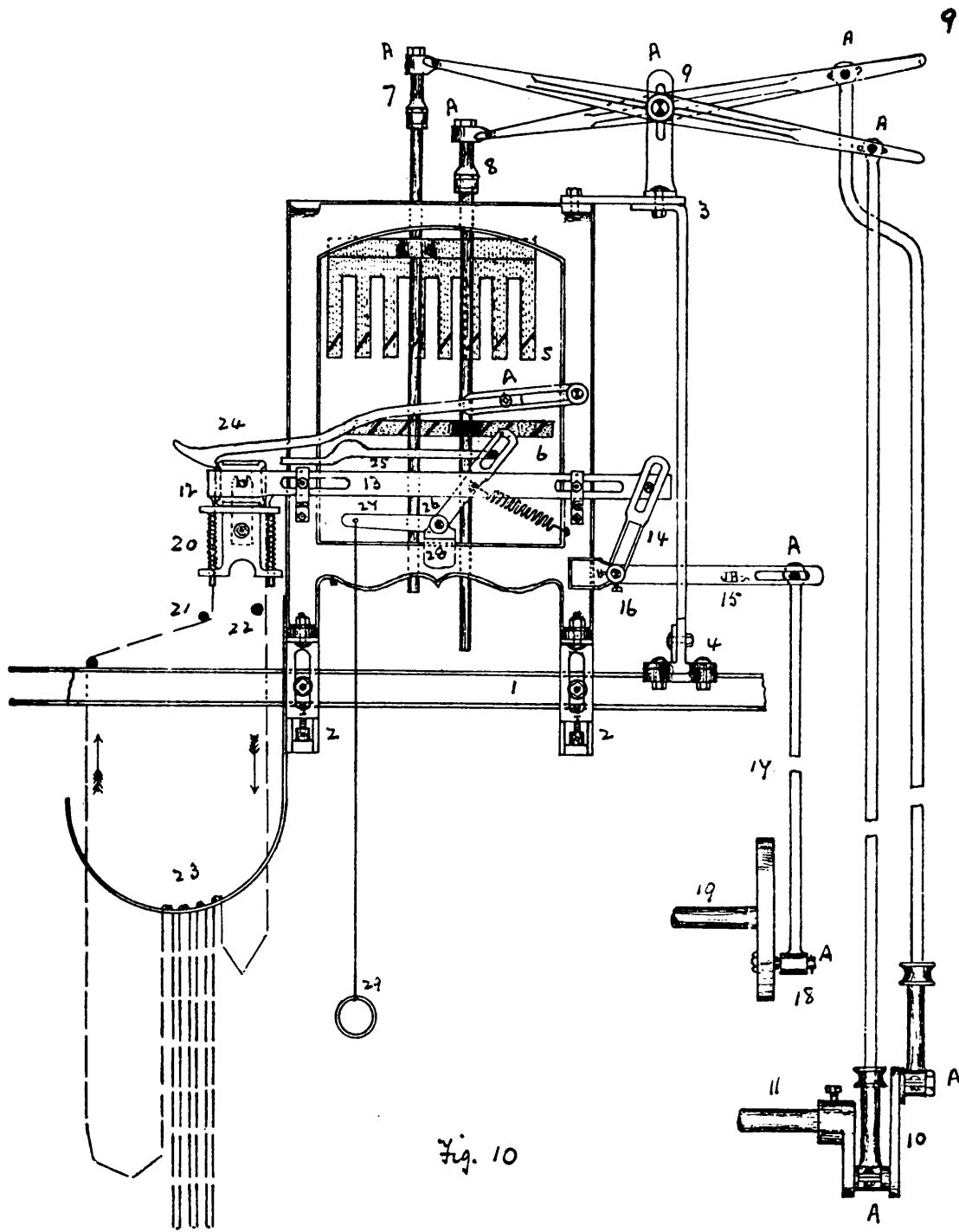

Arrangement of needles and hooks in a 400 Double lift, two cylinder Jacquard. Fig. 11 illustrates this type of machine, it is the one most commonly used in the cotton trade for weaving Picades and similar cloths. By employing two cylinders, the speed of the cylinders is reduced one half, this enables the loom to be run at a higher speed than in the case of a single cylinder, which is a decided advantage. The two cylinders 1 and 2 are placed one on each side of the machine, the needles from the respective cylinders work the hooks with their snout ends 3 and 5 facing them, the top needle 4 of the cylinder 1 controls the same thread as the bottom needle on the cylinder 2. The two hooks 3 and 5 are connected at the lower ends by the neck cord, 6. The cards are laced together in two sets, all the odd numbered cards for one cylinder and all the even numbered cards for the other cylinder, and they come into action alternately.

One of the difficulties to contend with in using a two cylinder Jacquard, is, that one cylinder is liable to get out of time with the other and spoil the pattern. Fig. 12 illustrates Riley & Riley's patent arrangement for stopping the loom whenever this occurs; two hooks 1 and 2, one on each side of the Jacquard are set apart for the purpose and are worked from opposite giffes 3 and 4. 1. is connected to the lever 5, 6, near to the starting handle 7. 1. is kept off the giffle 4 by the spiral spring 8 threaded on the needle 9. The cards are cut for the two cylinders, so that when the cylinders are working in proper order hook 1 is never lifted, but if they are not working in unison a hole on 2 is followed by a hole on 1. This permits hook 1 to be hushed on to the giffle through the spring wire connection 10 and 11 with fulcrum at 12, and the loom stops.

Fig. 13 illustrates a method of reversing card cylinders to find a broken kick, by gripping handle 1, cylinder and electric are disconnected, then moving handle too & fro the cylinder swings in and out. The cover catch is brought into action at the same time & turns cards back.

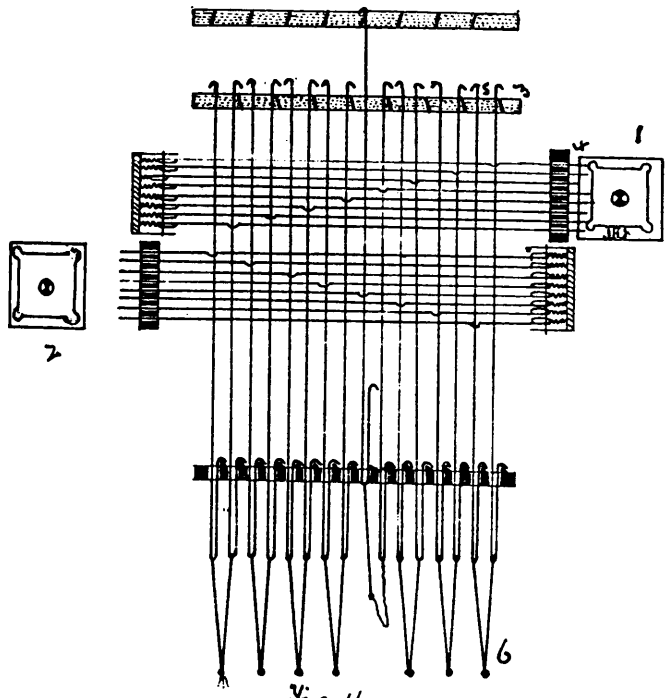

Fig. 11.

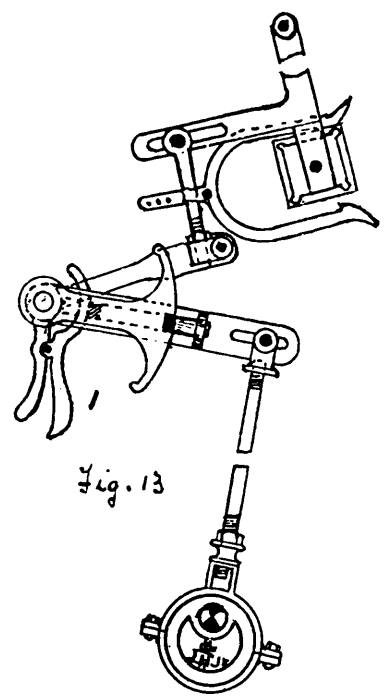

Fig. 13

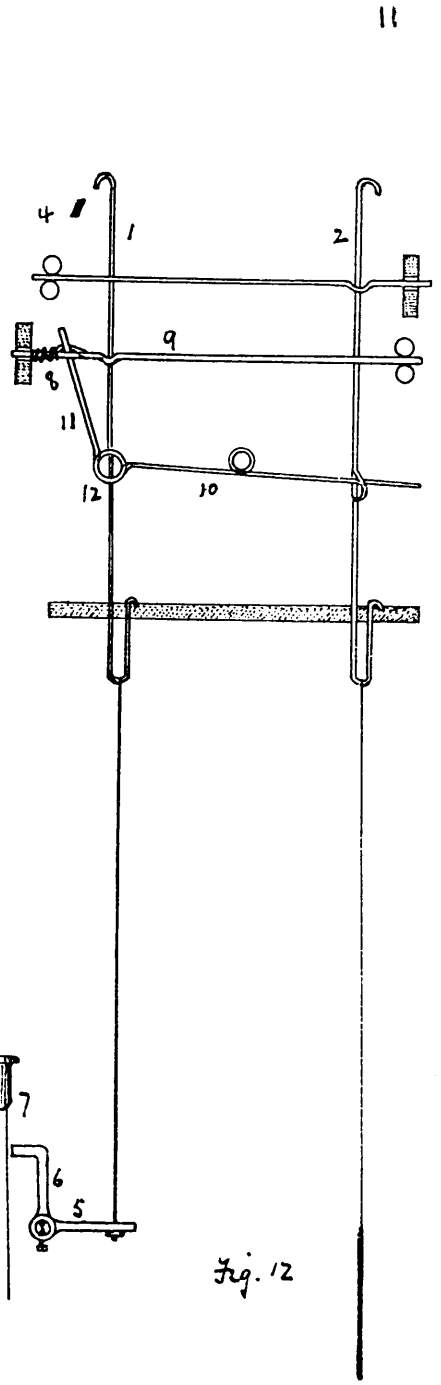
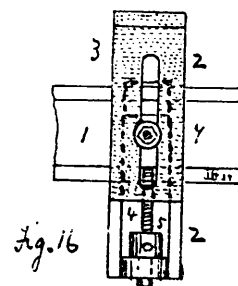
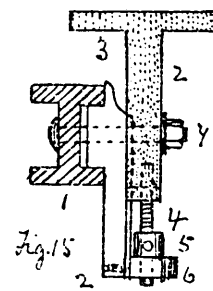
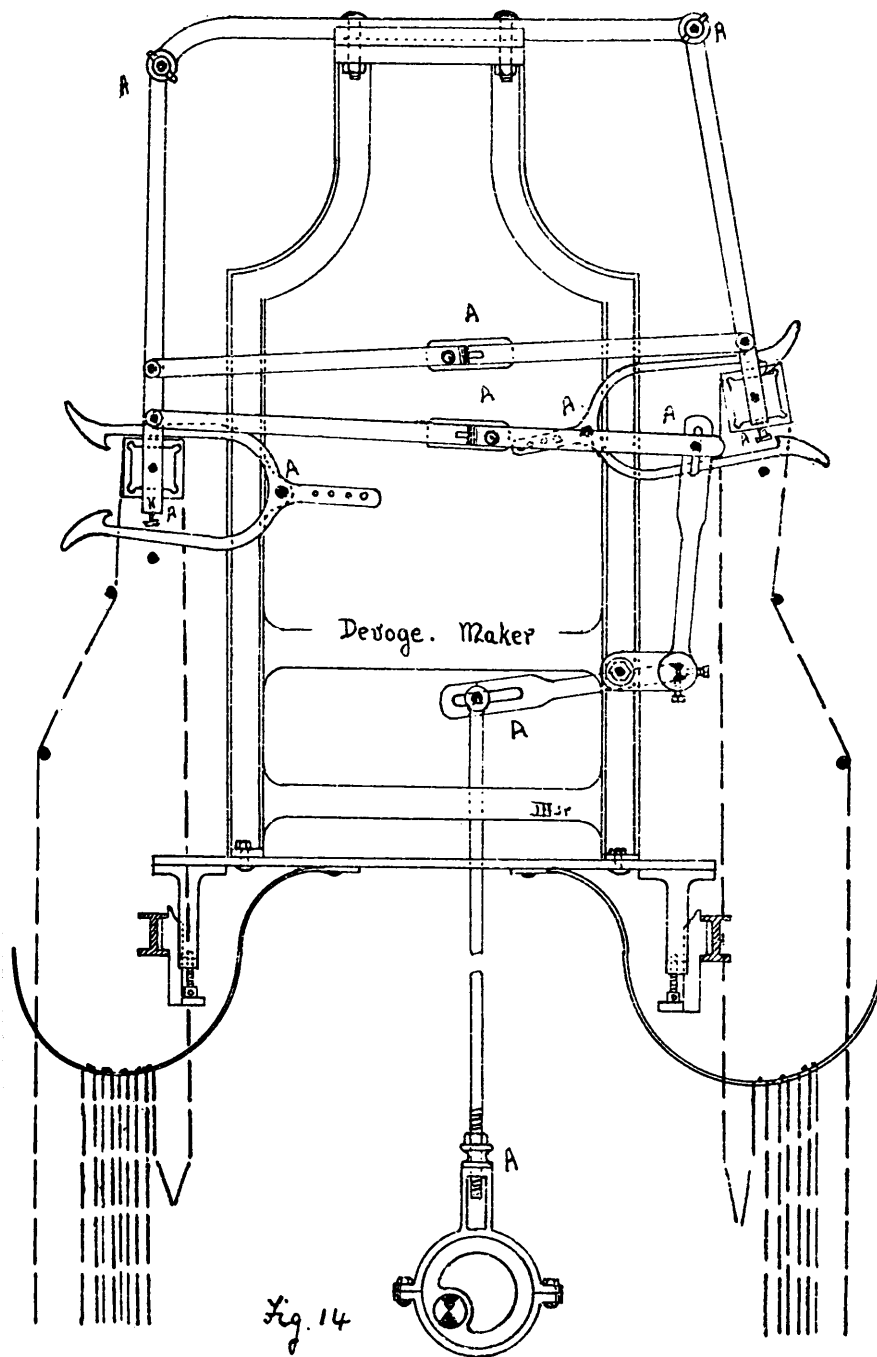

Fig. 12

Two cylinder, Double lift, Swinging cylinder jacquard.

Fig. 14 illustrates the working of the two cylinder machine. 1. gives an end section of the gantry for supporting the machine, with adjustable feet for raising and lowering the jacquard. 2 and 3 show the two cylinders suspended from swinging arms or batters 4 and 5 with their fulcrums at 6 and 7 respectively. The working is as follows - fixed to the bottom shaft of the loom is an eccentric 9 connected through the rod 10 with the lever 11, 12 with fulcrum at 13. The cylinder 2 is connected to the lever by the rod 8. The revolving of the eccentric causes the cylinder 2 to swing in and out, the turning catch 14 gives the cylinder a quarter turn for each outward swing. The swinging arms 4 and 5 of the cylinders are connected by the adjustable rod 15, so that as cylinder 2 comes into action cylinder 1 swings away from the needles, and also when cylinder 1 is brought into action cylinder 2 swings out of action. The double catches can be pulled into action for reversing the cylinders or turning back the cards when finding a broken pick due to the weft breaking. Points of adjustment are shown by the letter A.

Fig. 15 and 16 gives detail drawings of the mechanism for raising and lowering the jacquard, an operation which is sometimes necessary due to the harness stretching and other causes. 1 is the gantry rail and bolted to it is the bracket 2. 2 serves as a slide in which the bracket 3 can move, connected to 3 is a screw 4 on which is threaded a nut 5 which rests on the lip 6 of bracket 2. By slightly unscrewing nut 4 and turning nut 5 the machine can be easily raised and lowered.



14
Cross Border Jacquard. Fig. 14 illustrates the working of a cross border machine. two cylinders are used 1 and 2. one of them (2) carries the cards for the body of the cloth, the other (1) carries the cards for the cross border. both cylinders are never working at the same time. 3 is the upright rod for working the cylinders, its lower end is connected with an eccentric 4 fixed on the crank shaft of the loom, its upper end is connected to the lever 5. 6 with fulcrum at ^a, 6 is connected to lower end of short lever 7. 8 with fulcrum at 9. at the respective ends of this lever are bowls 10 and 11; the rod 12 to one end of which the cylinder 2 is fixed, has at the other end a space 13 hollowed out at the top, into which the bowl 10 fits. If the loom be set in motion with all the parts in the positions shown in the sketch, the cylinder 2 will work and cylinder 1 remain stationary.

The short lever 14 is connected by means of a cord 15 and spring to the lever 16 with fulcrum at 14; in changing from one cylinder to the other, the lever 16 is pulled down by hand, bringing the cord 15 and lever 14 a like distance, attached to 14 is the rod 18 connected with the rod 19 at the other end of which is fixed cylinder 1, at the other end of this rod is a space 20 hollowed, when the cord 15 is pulled down the rod 19 is lowered so that the bowl 11 fits into the hollowed out portion 20. at the same time 21 is lifted bringing up 12 so that the bowl 10 is no longer in the hollowed out portion 13; the cord 22 is pulled down so as to bring the lower catch 23 into action, for the purpose of reversing the direction of motion of the cylinders when it is required to put in the cross border pattern in

the reverse order. If the loom is now set in motion cylinder 1 only works and cylinder 2 remains stationary.
Letters A. indicate points of adjustment

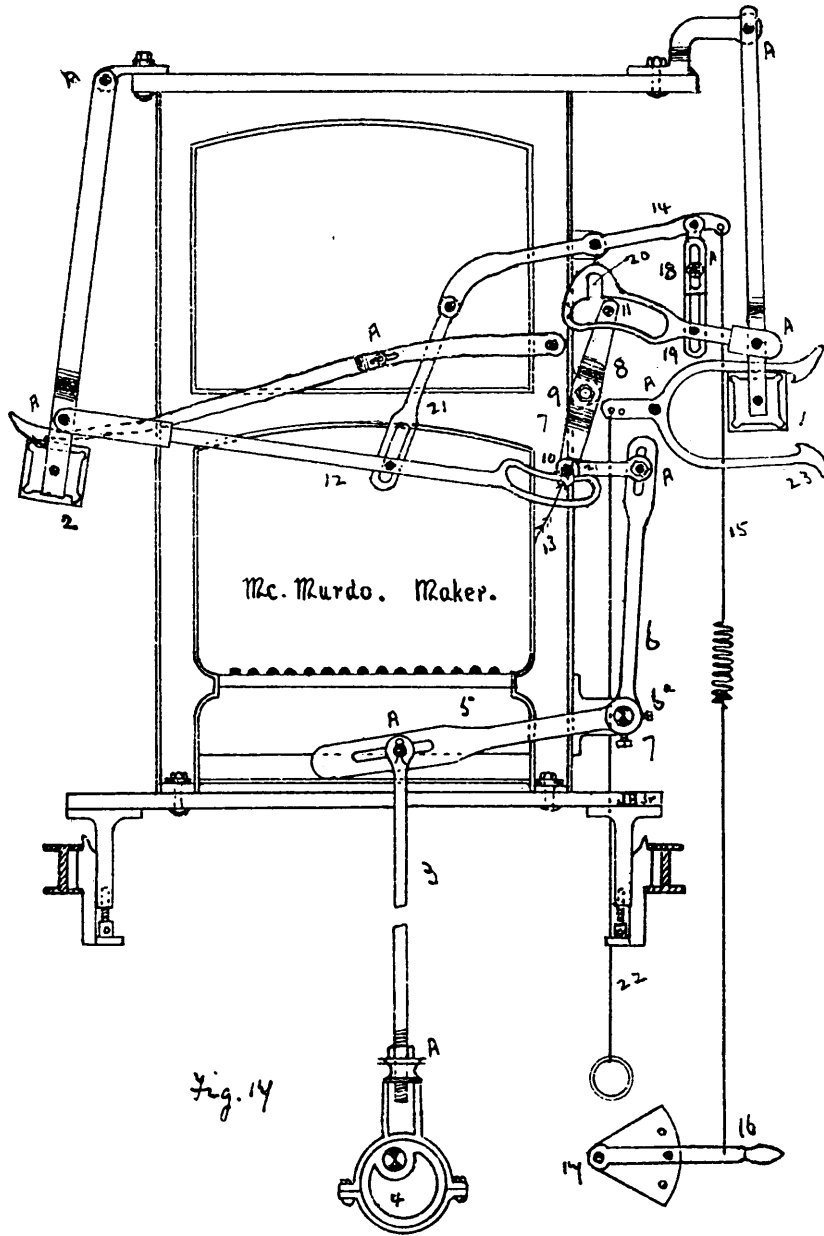
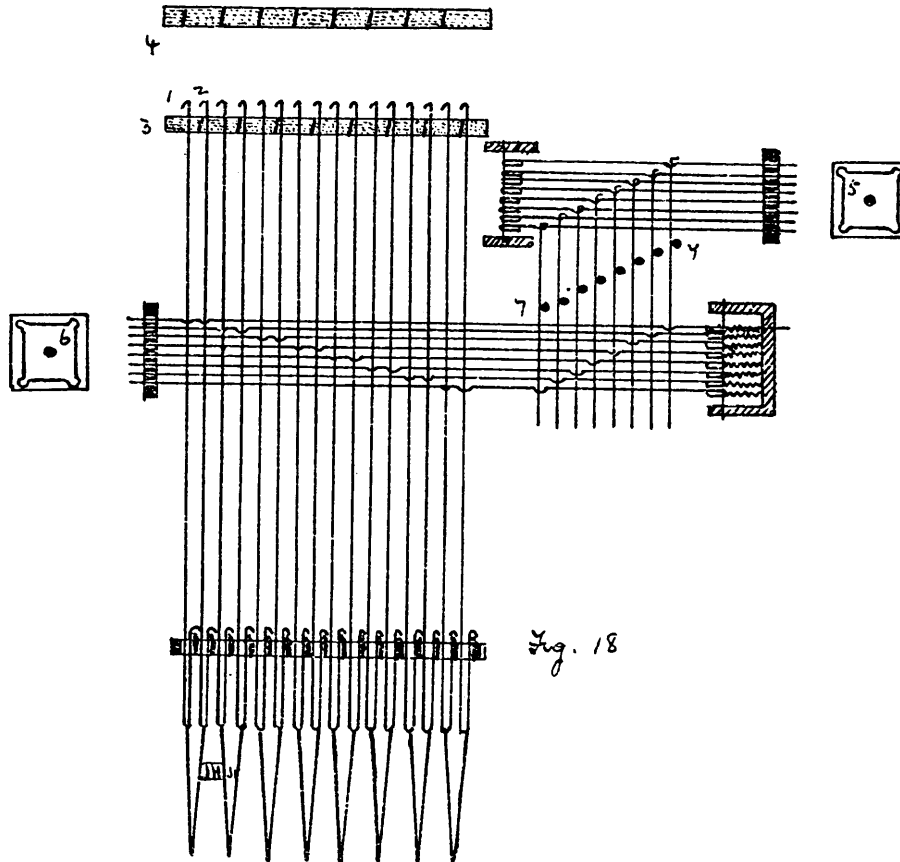
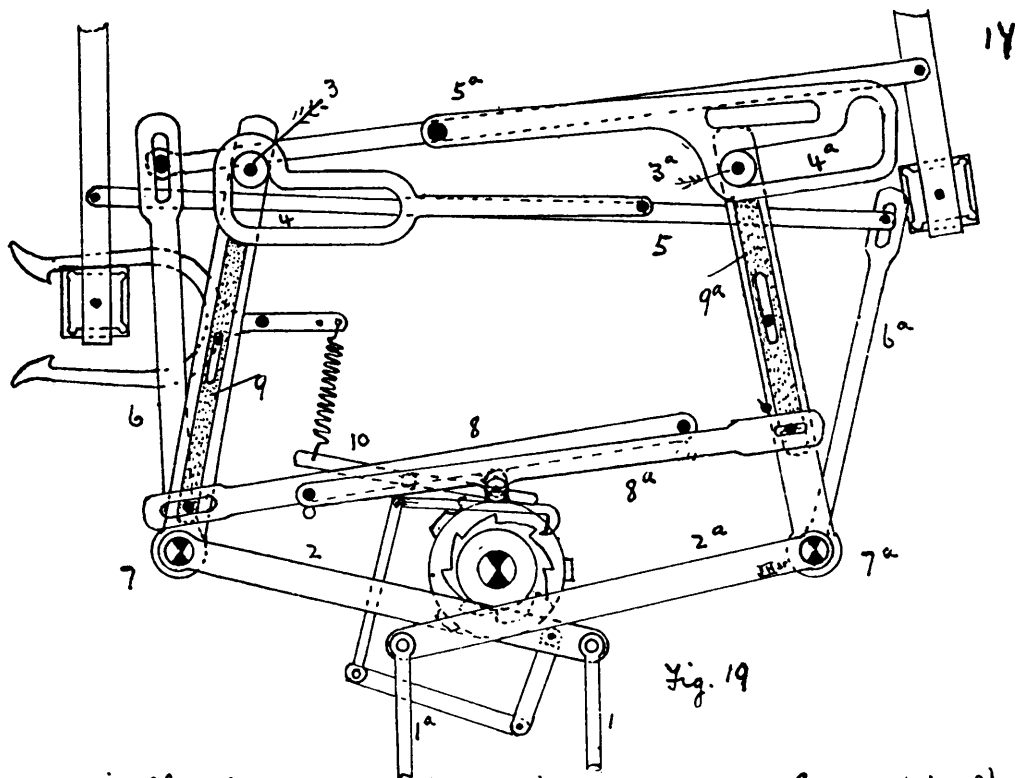

Fig. 14



Cross Border Double Lift Jacquard. Fig 18 illustrates the arrangement of needles and hooks in this machine. there are two cylinders 5 and 6 but they are never both acting at the same time, each cylinder being brought into action as desired to weave the body of cloth or cross border, the two hooks 1 and 2 can lift the same thread of warp, depending upon which of the two cylinders are in action. 3 and 4 are the two lifting giffes. The needles from cylinder 5 are connected to the needles from cylinder 6 by short lengths of wire with fulcrums at 7. It will be seen that when cylinder 5 is out of action, the needles 6 will be able to operate the hooks on or off the giffes as the blanks and perforations in the card decide. Also when cylinder 6 is out of actions the cards on cylinder 5 will be able to operate the hooks in like manner.



Automatically changing the cylinders of a Cross (Fig. 19) Border Jacquards. The cylinder connecting rods 1 and 1^a actuate bell crank levers 2 and 2^a, which have bowls at each end of the vertical arm, these bowls work in C shaped slots 4 and 4^a and operate the cylinders through the connecting levers 5 and 5^a, the arms 6 and 6^a are loose on the shafts 7 and 7^a. The C slots are so arranged that when one bowl is in action the other one is out of action. The change from one cylinder to another is brought about by the levers 8 and 8^a which rest on a barrel carrying three chains made up of bowls and blanks, so that when a bowl comes under a lever it will raise it, lifting the shaded part 9 and 9^a on which the C slots rest and so putting that cylinder out of action. The barrel is turned every repeat by a special hook of the jacquard; the third chain on the barrel operates the lever 10 and changes the direction of the border cylinder when necessary. Robbells Patent.

Open Shed Jacquard.

In a single lift jacquard each thread drops to the lowest point on each pick, and if required to be up for the next pick it is again lifted; with the introduction of the double lift machine, if a thread is required to be lifted for two picks in succession, it only drops half way when it is again lifted by the ascending giffe. The motion which gives the least strain to the warp and reduces the friction to a minimum, is, to keep each thread at its highest point, until required to change to suit the pattern. If an end is required to be lifted for two picks in succession it is lifted to the highest point on the first pick and remains there until it is required in the bottom shed to suit the pattern; machines of this description are known as Open Shed Jacquards. Fig 20 illustrates the principle of Thomis & Priestley's patent. One needle 1 operates two hooks 2 and 2^a either of which can lift the same end; the hooks about midway of their length at 3 are bended; a few inches from the bottom at 4 it is bended still more, so as to form a kind of lip, between each pair of double hooks there is a stationary bar 5; hooks 7 and 7^a are shown down; hook 2 is lifted by the giffe 8 and it lifted sufficiently high that the lip 4 in the lower part of the hook comes above the stationary bar 5, if the hook is required to be up for six picks in succession, the cylinder comes to the needles with a hole in the card opposite to the needle 1 and on each pick this occurs, there is no action, on the next pick a blank comes opposite to the needle 1 pushing it back just at the moment hook 2 is being lifted and dropped the extra quarter of an inch, and, as the hook drops owing to the action of the needle it falls clear of the stationary bar

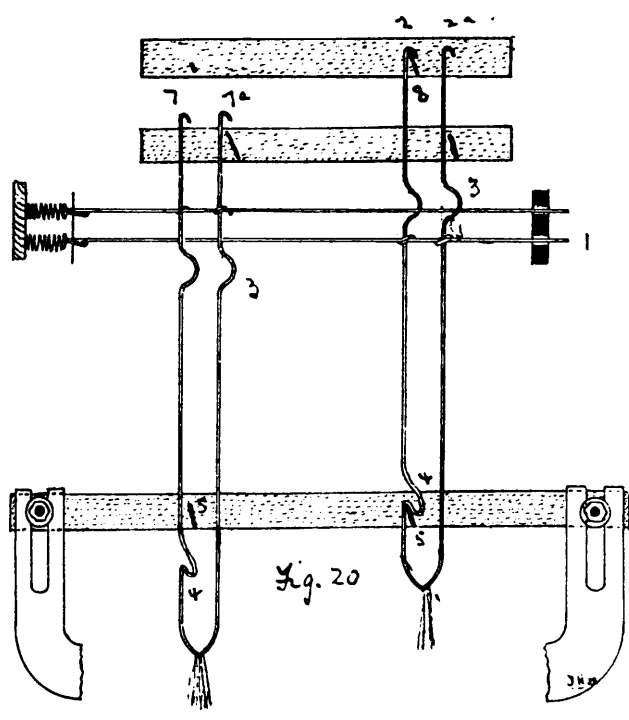

Fig. 20

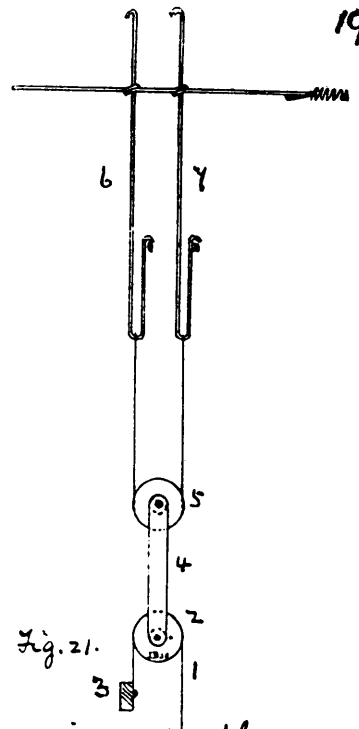
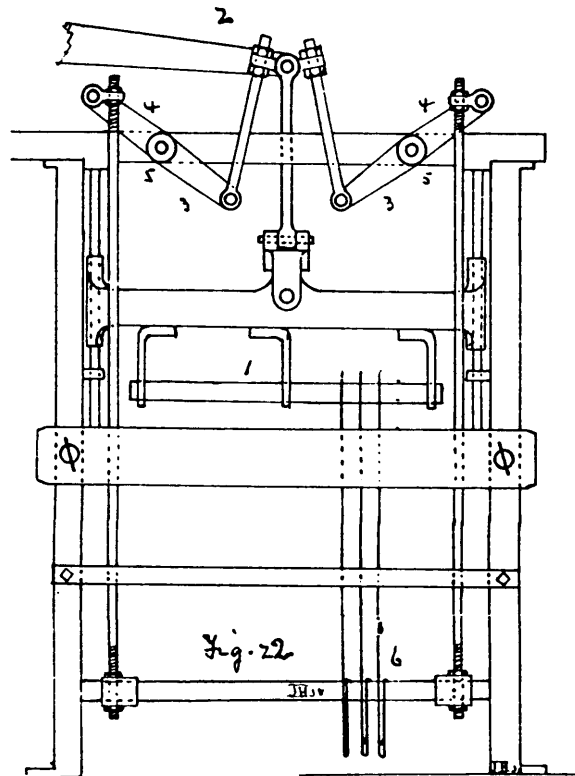

Fig. 21

5 and comes down with the falling gripper; just at the time the grippers are passing each other the bended portion 3 of the hooks are passing through the slots in the needles; this action allows the hooks to spring back a little so that the ascending gripper clears the falling hooks.

Wilkinson's patent arrangement is shown in Fig. 21; each harness cord 1 passes over a grooved pulley 2 and is then attached to a fixed block 3. The pulley 2 is connected to the grooved pulley 5 by connection 4, passing around 5 is a cord the respective ends of which are connected to two separate hooks 6 and 7 either of which can be operated by one needle; two grippers are used and if a thread is required to be up for two picks in succession it is lifted by one of the hooks on the first pick, on the next pick the other hook goes up so that the slack cord of the descending hook is taken up by the ascending hook and the thread remains unaffected.



The Centre Shed Jacquard.

In this machine the whole of the harness is lifted to the centre shed on each pick. Fig. 22 illustrates its action the gripe 1 is made to rise and fall in the usual way, through the top lever 2, which is connected by a rod to an eccentric fixed on the crank shaft of the loom, the end of lever 2 is also connected to the levers 3, 4 with fulcrum at 5, the other ends of these levers are connected to the bottom board on which the hook 6 rests; in making a selection of hooks, the bottom board brings all the hooks to a centre shed at the same time, when the selection of hooks has been made, the gripe ascends taking up those hooks left in position by the holes in the card, the bottom board descends by the same action as causes the ascent of the gripe, and those hooks resting on the bottom board form the lower shed. Mortimer Fane A & Waite Patent

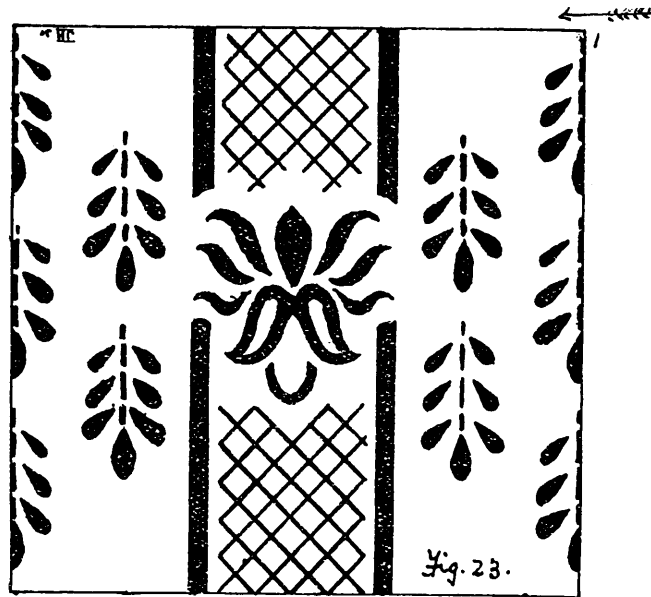

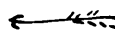

Card Cutting.

The work preceding card cutting is the preparation of the design, this is first done cloth size on plain paper and then repeated a sufficient number of times to see what the general effect of the pattern will be, it is then enlarged and painted up on design paper. It is not at this stage deemed advisable to deal with jacquard designing but just to point out how the design is put up at the Card cutting machine in readiness for card cutting. Fig. 23 gives a simple stripe pattern and it is placed in front of the card cutter inverted as shown in the sketch. The cutter commences on the first pick on the right hand and travels in the direction of the arrow , each pick on design paper represents one card, and each lot of eight ends between the thick lines or "bars" on the point paper represent the cutting for one row of hooks or needles.

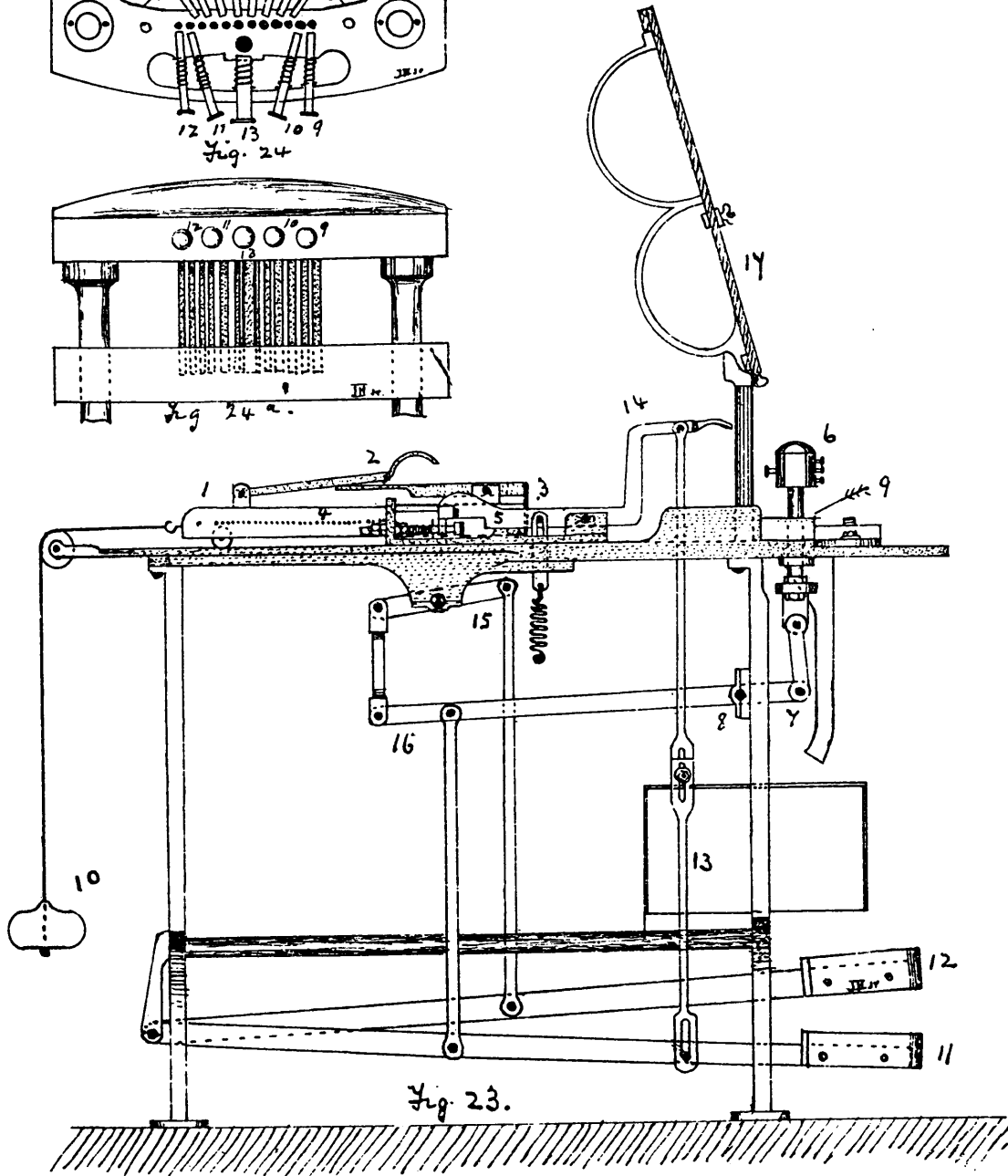
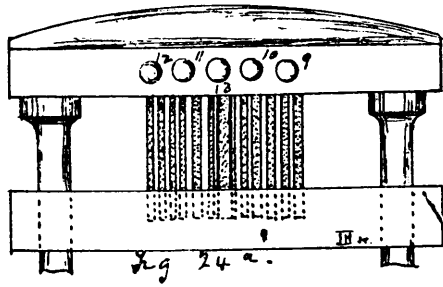
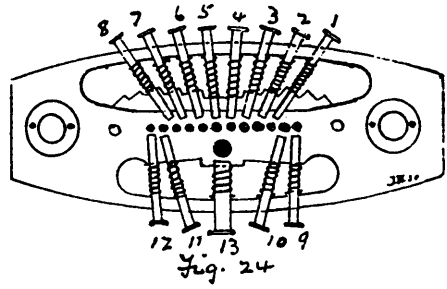
22 Card Cutting. A card cutting machine is used for perforating the cards in the order of the filled in squares on design paper. In a 400 jacquard a card with 50 rows of holes, 8 holes in a row is required to correspond with the 50 rows of needles in the machine. Figs 23 illustrate the principal parts of a card cutting machine. Fig 24 shows a plan of the punch box, the spring punches numbered 1 to 8 are used to cover 8 cutting punches, this corresponds to one row of holes in the card, and represents the 8 squares between the thick lines on a piece of "point" or design paper; 13 is the larger punch for cutting the peg holes at the beginning and end of a card, 9, 10, 11 and 12 are used when cutting a card 12 holes wide, as in a 600 jacquard with 12 needles in a row. Fig. 23 gives a side elevation of the machine, 1 is the carriage for holding the card and drawing it beneath the punches for perforation, 2 and 3 is the card clip, 4, is 50 small pins fixed to the carriage, they are the same distance apart as the rows of needles in a jacquard machine; 5, is a regulating slide which allows the carriage to move a distance of one pin at each movement; 6 is the punch box connected to lever 7 with fulcrum at 8, it is free to rise and fall with the upward and downward movement of 7; 9, are two perforated plates between which the blank card is drawn, in the upper of the two plates are the cutting punches; 10, weight attached to the carriage; 11 and 12 foot treadles for working the machine; 11 through the connecting rod 13 pulls down 14 and operates the slide 5, this allows the carriage to move a distance equal to one pin, it also lifts the punch block 6; the punches 1 to 8 are pushed in as required to suit the pattern, 12 is then pressed down and through the connecting levers 15 to 16 brings down 6 and punches the card. 17 is the upright table for holding the point paper.

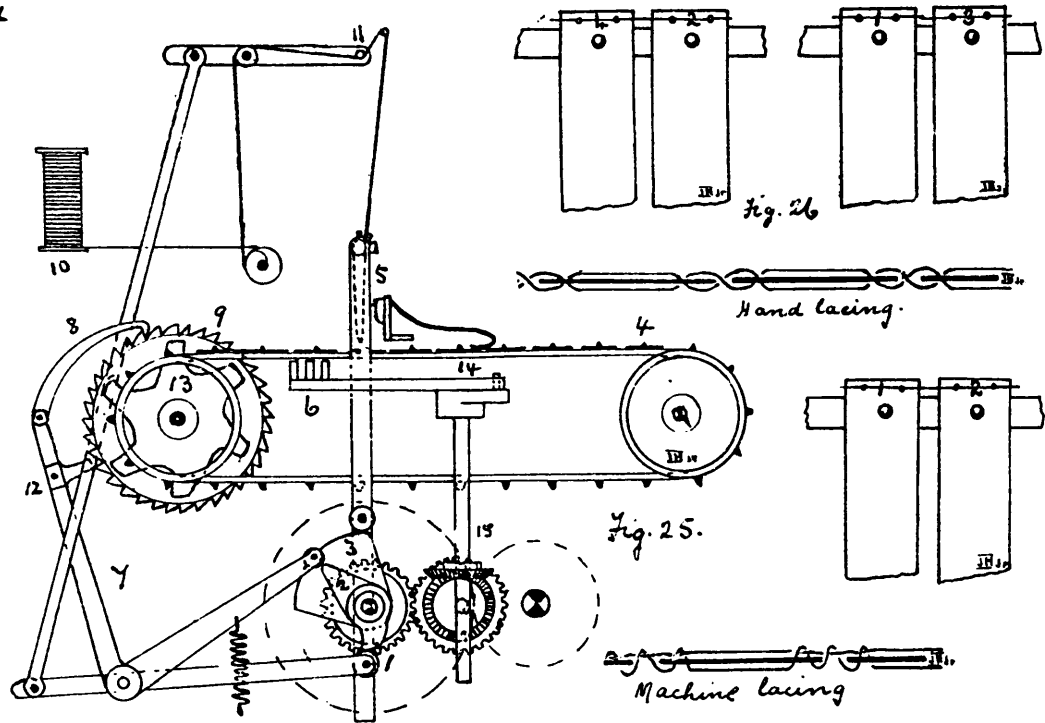



Card lacing by hand is shown in Fig. 26. Lacing by machinery is illustrated in Fig. 25. The machine consists of an endless belt 4 on to which the cards to be laced are fed, a lacing needle 5 and a shuttle holder 6, which are worked by suitable mechanism. The cam 3 gives the lacing needle a up and down movement and the cam 2 operates the bell crank lever 7 to which is attached a hawl 8, which pulls round the toothed disc 9 to which the card belt is attached and feeds the cards. The lacing twine is taken from the bobbin 10 to the lacing needle, the twine passing over the tensioning bar 11 which is operated by the cam 1 allowing the thread to go slack when required. Owing to the distance between the lace holes being varied  it is necessary that a variable motion should be given to the belt, this is done by the pin 12 and the star wheel 13, for a short movement the pin is brought against one of the teeth, for the larger distance it is allowed to go into the hollow and take more teeth of the ratchet wheel. The shuttle holder 6 is reciprocated by the crank and arm 14 driven from cam shaft 15.
G. Paulick, Patent.

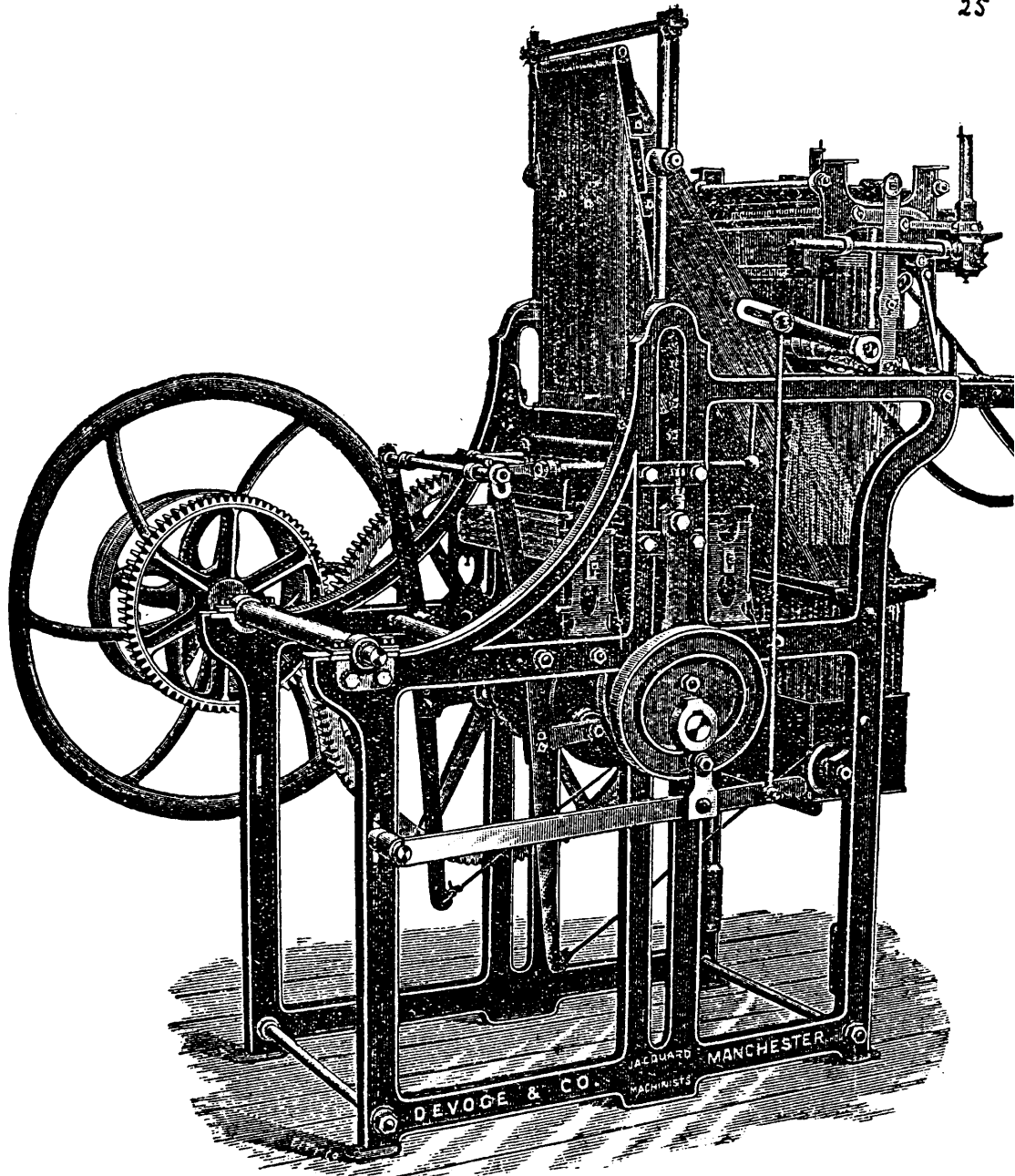

Fig. 24.

26. Card Repeating Machines. After a set of cards have cut from the design at the Piano Card cutting machine and laced together in the usual way, if a duplicate set is required, which is the case when many looms are weaving the same design at the same time, it is usual to duplicate the set of cards on a Repeating Machine, and, for that purpose a jacquard machine is the means whereby the set of cards are duplicated, the different machines in use perform the work in much the same way differing in detail only. Fig. 27 gives an illustration of the Duvoy Repeater and Fig. 28 a detail sketch a 400 or 600 single lift jacquard is mounted on a framing, the hooks 2 operate harness 3 to which heavy lingoes 4 are attached, cords 5 attached to harness pass over guide heddles 6. at the other end of cords are punches 7; 400 punches are arranged in rows of 8 in a row, 50 rows in all, over a perforated plate 8. The set of cards to be repeated are passed over the cylinder 9. the holes in the card select the hooks and through the cords 5 the punches 7 are lowered, the lowered punches are locked in position, the plate 8 rises and the punches pass through the card. The locking of the punches is shown in detail in Fig. 29

In the McHardy Repeater Fig. 30 the wire connection between the hooks and the punches is made up of two parts, 1. 2 with a spring embracing one of them to keep the wires apart. When a set of cards is passed over the cylinder 3 of the jacquard, the punches will rise and fall, with this difference, the hooks being turned the opposite way a blank indicates a rising hook and a hole a hook and therefore a punch left down, the punches are locked by means of a sliding comb, the teeth of the comb slides into the upper slot of the punches left down and into the lower slot of the lifted punches, the blank card is placed in position the punches descend and pass through the card.

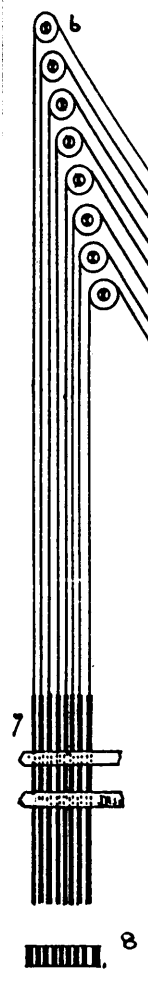

Fig. 27

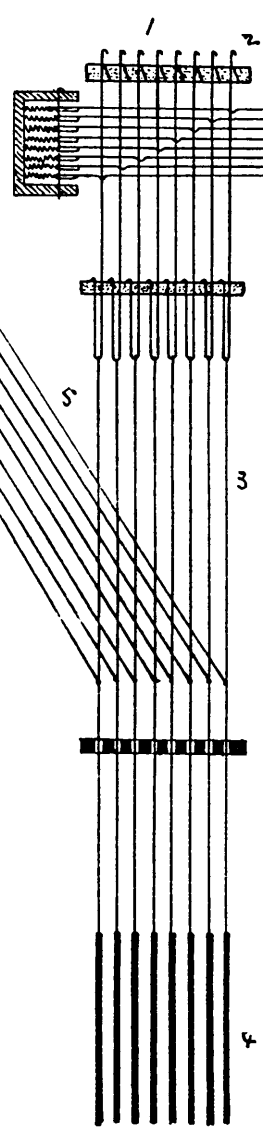

Fig. 28

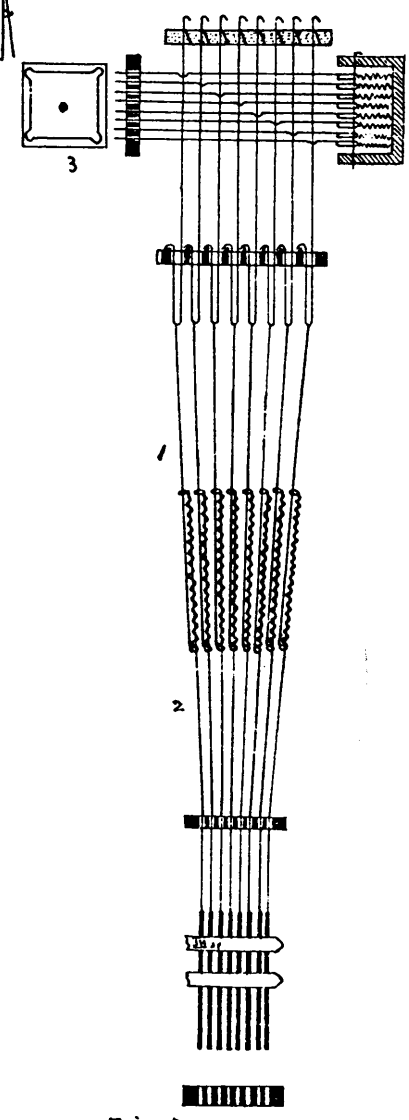

Fig. 30

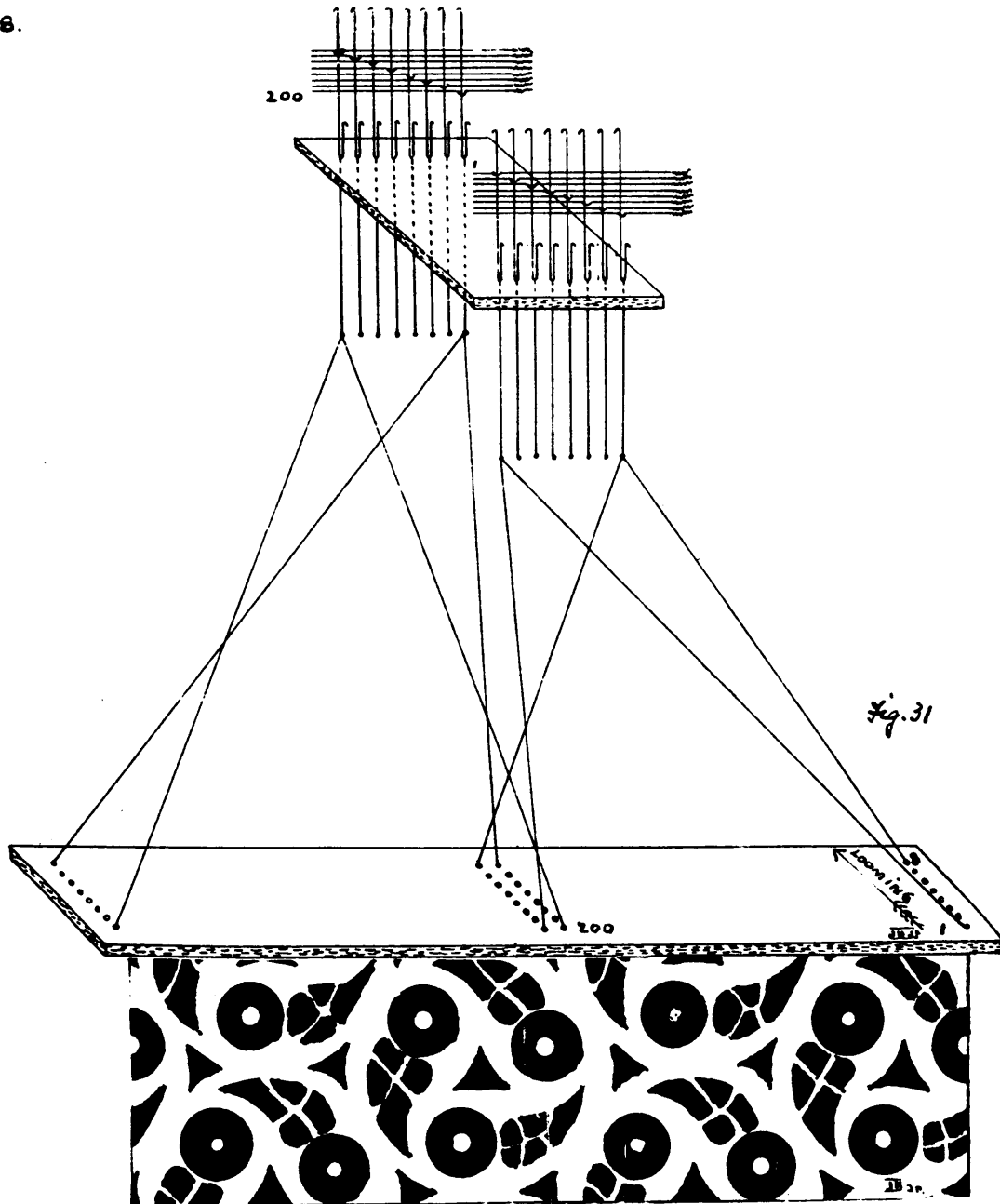

Fig. 31 illustrates the straight tie with the cards at the side of the loom (Random tie) with a crossed hammers. The 1st and 2nd hooks and the direction of looming are shown. Norwich tie page 5 Fig. 3.

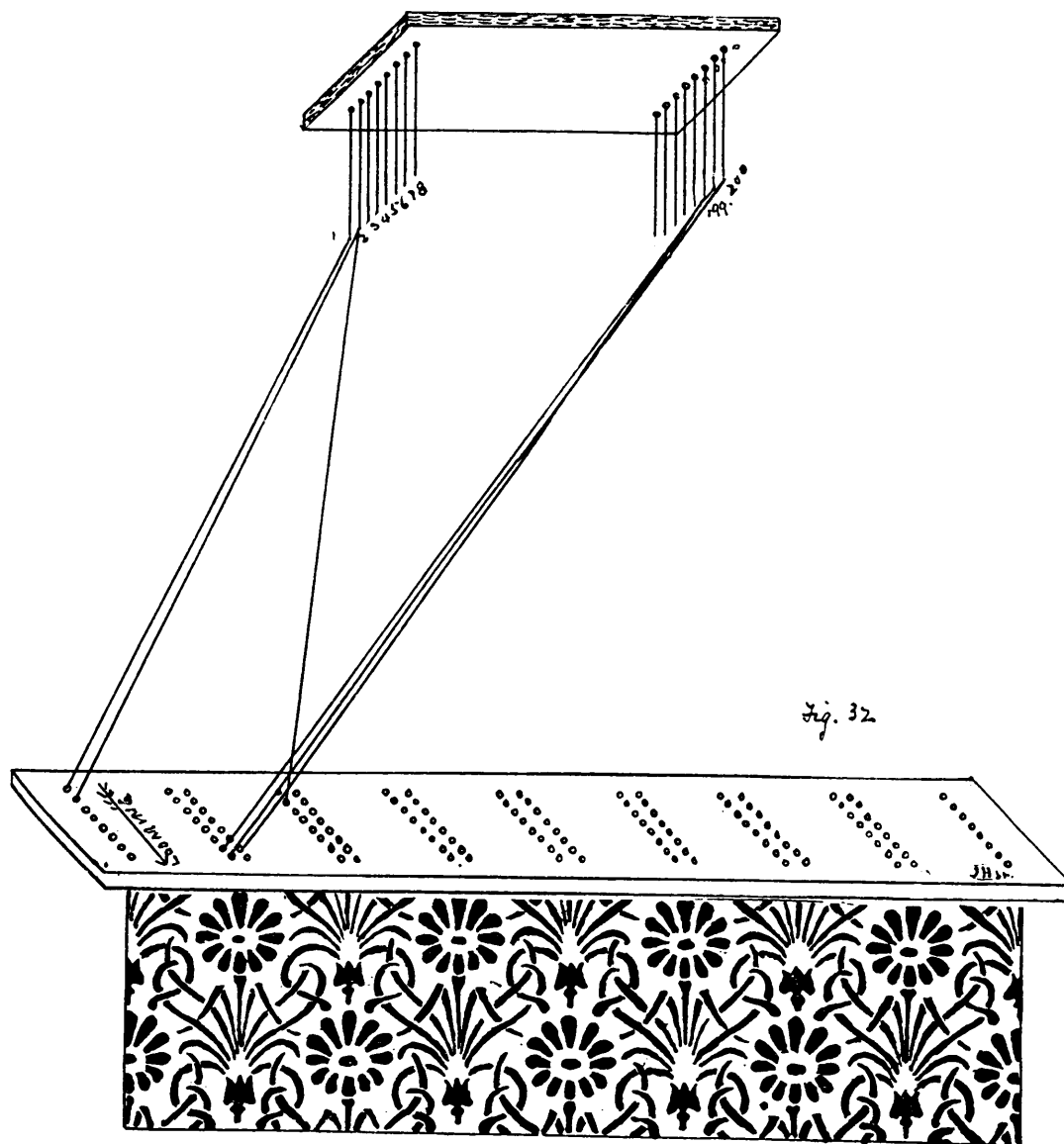

Fig. 32

Centre tie. Fig 32 illustrates this form of tie-up. A Jacquard of 200 hooks is tied up in the harness to weave a pattern standing on 398 ends in one repeat, the 1st and 200th hooks operate one end each in one repeat, all the other hooks work two end each. The direction of arrows indicate loomings.

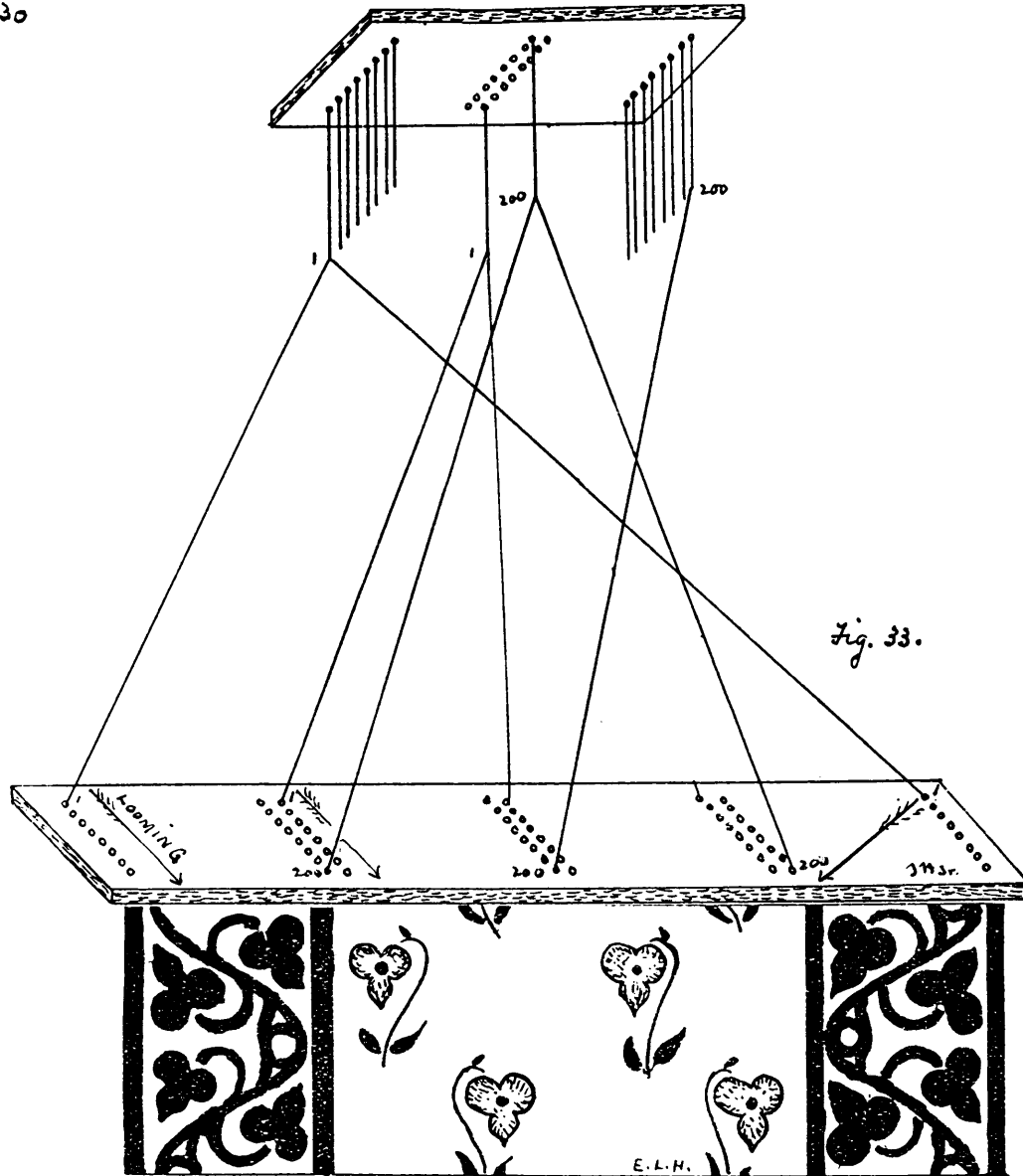

Fig. 33.

Border-tie. Fig 33. illustrates this form of tie-up. a 400 Jacquard is divided into two parts, 200 hooks are set apart for the border and 200 hooks for the body of cloth pattern. The arrows indicate the direction of loaming.

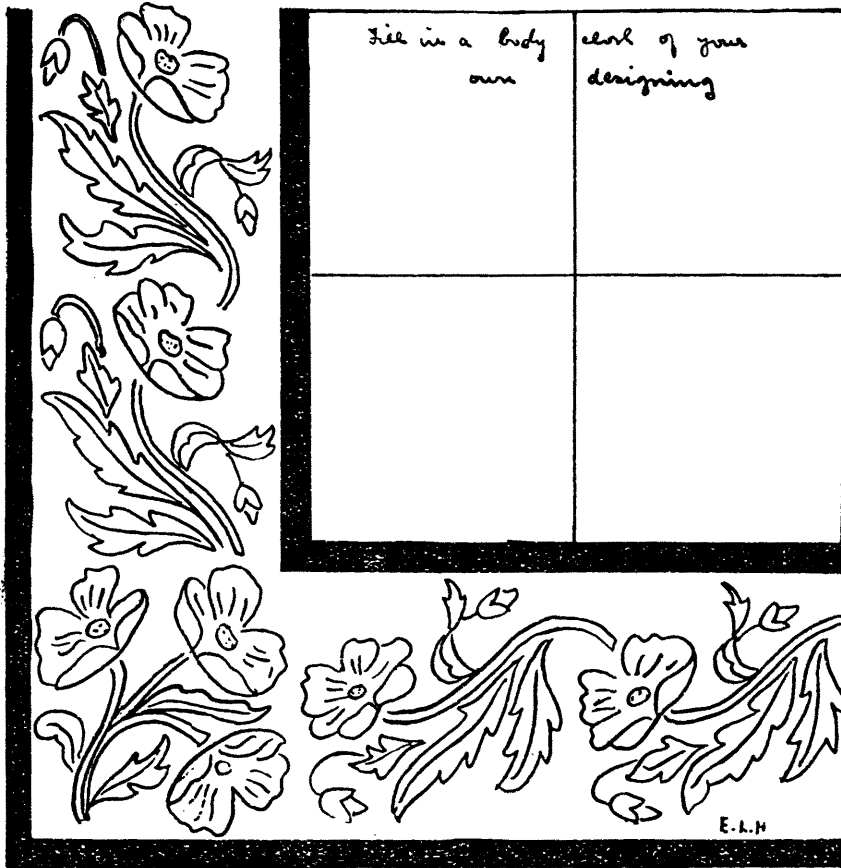

Fig. 34

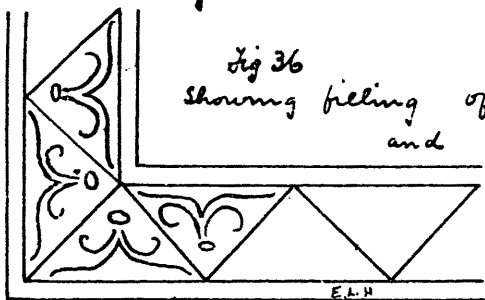

Fig 36
Showing filling of
and

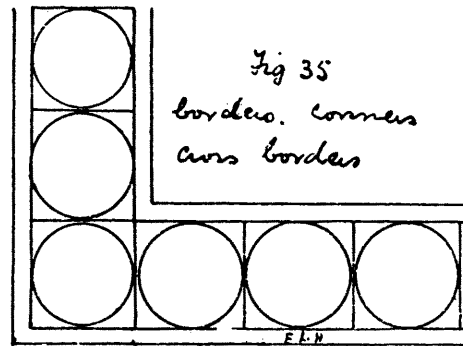

Fig 35
border. corner
and border

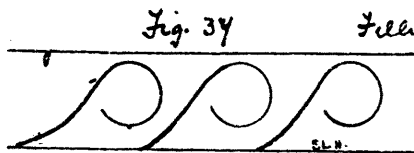

Fig. 37

Filling



Fig 38.

32 Cross Border Jacquard Tie-up. A form of tie up used for Towels, Rugs, Handkerchieves, mufflers and Table covers is shown in Fig . A 400 Jacquard is selected for the example, it is divided into two equal parts, allowing 200 hooks for the middle of the cloth and 200 hooks for the border. The border hooks have two leashes tied to each hook, this allows the 200 border hooks to work the patterns for both side borders, the side border is usually the same pattern as the Cross border, a separate pattern is designed for the corner, it must be of such a character that it is common to both borders. The spaces A, A, C, D gives one repeat of the pattern for the side border and middle (centre) the side being cut on one half of the card and the body pattern on the other half. A separate pattern D, E, F, G is designed for the corner, the side border is then taken and placed in position E, C, F, G, another set of cards is now cut, the pattern D, E, F, G being cut on the border hooks, the pattern E, C, F, G being cut on the body hooks. In weaving a handkerchief for which it is assumed this pattern is suitable, the Cross border cards are first put up at the Jacquard and one repeat only is woven, these cards are taken out of action and the side border and body cloth set of cards are put up, and about a yard of cloth is woven, or whatever length desired, these cards are then put out of action and the cards for the Cross border brought into play, the direction of motion of the cylinder is reversed and one repeat only of the pattern is woven, and the handkerchief is complete.

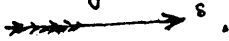
The method of tying up the harness is shown, by dividing the comb board into sections as before stated, 200 hooks are used for border and 200 hooks for body of cloth, the directions for drawing the ends through the harness is indicated by .

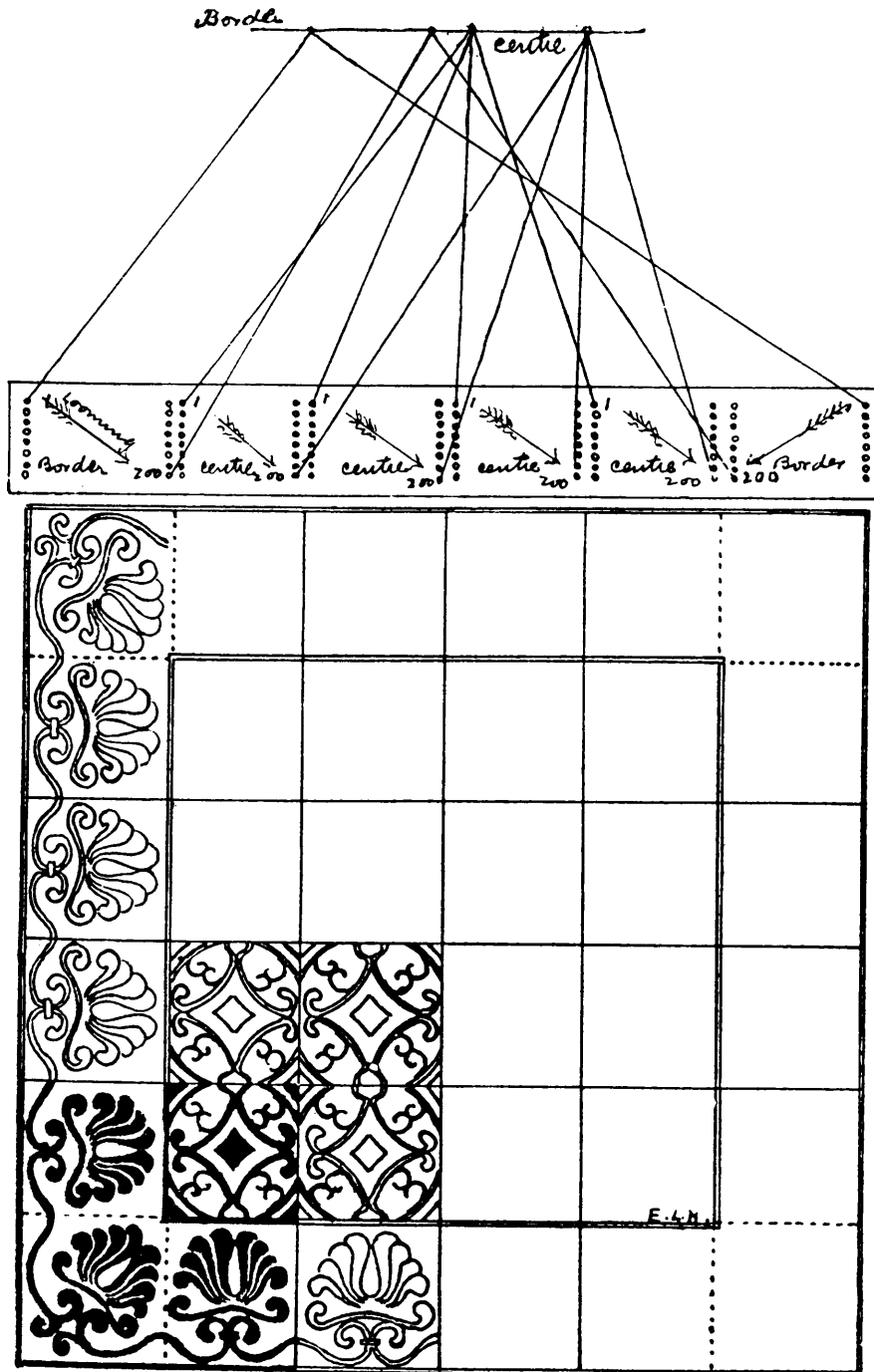
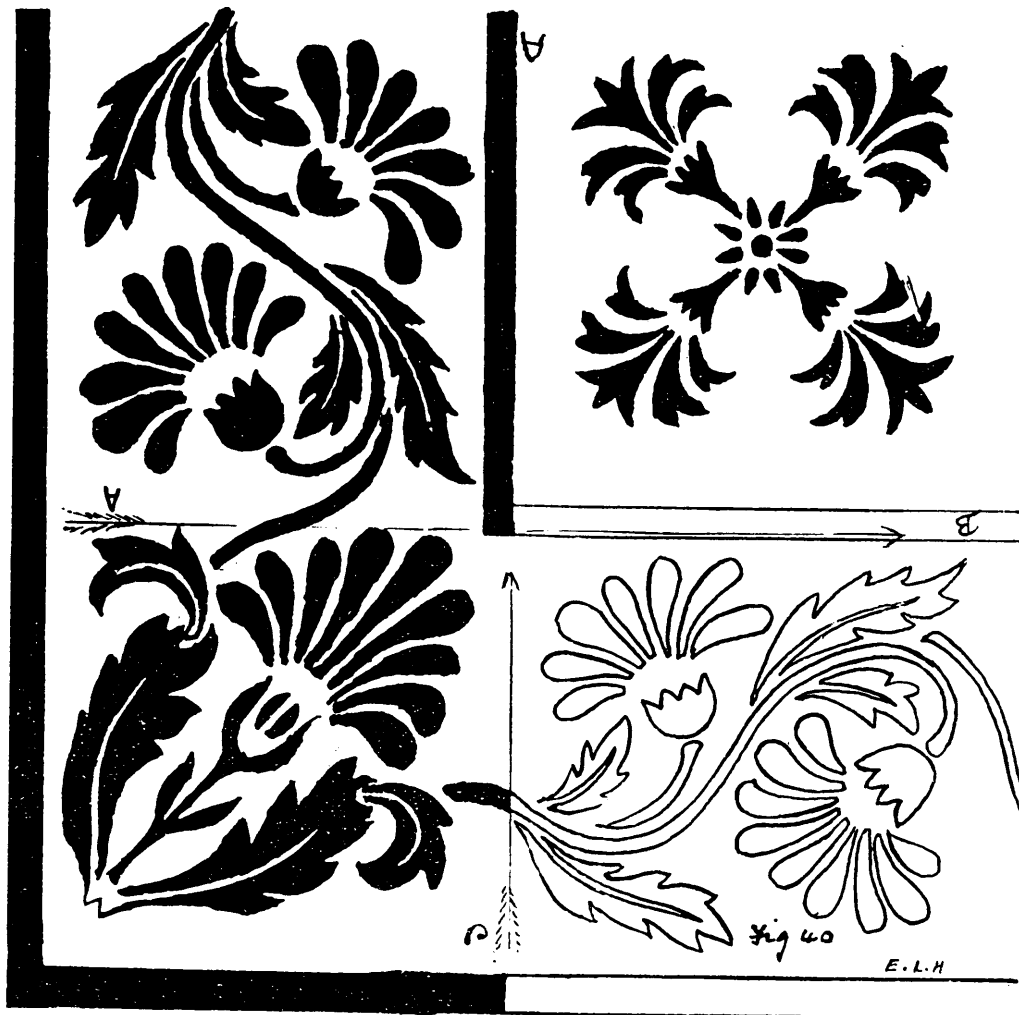

Fig 39.



Sketch for a Cross Border Design. Fig 40 gives a prepared sketch, cloth size. 80 Reed. 200 hooks for border and 200 hooks for body of cloth. The part in solid is enlarged and painted up on point paper. In card cutting, the border is cut on the 1st 200 hooks, for the body of cloth set of cards cut on line A. B in the directions shown, for the border set of cards, cut on the line C. D in the directions shown.

Tackling Jacquards.

Timing and setting. The machine is mounted above the loom, with the centre of the machine over the centre of the loom, with the mail eyes of the hammers on a level with a straight steel ruler lying flat and level with the race board when the reed is to the harness as shown in Fig. 41

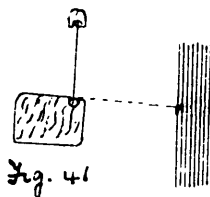

the distance from the reed to the middle of the hammers being from 3 to 4 inches.

The top levers are set level at the time that the giffes are passing each other, the cylinder level is also level at the same time, the crank of the loom at this moment being on the top centre.

Fig. 42 illustrates the setting of the cranks or eccentrics for a two cylinder double lift Jacquard. Fig. 43 illustrates the setting of the cranks and eccentrics of a double lift single cylinder Jacquard.

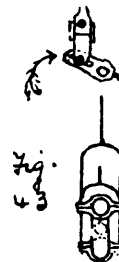
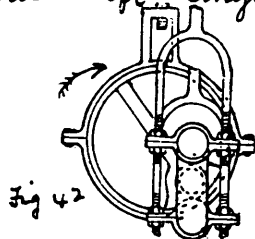

Note that the crank or eccentric of the cylinder is set just a little later than the cranks of the rods for the lifting giffes. whenever a giffie is at the bottom making a selection of hooks, there must be a clearance of the of from $\frac{1}{4}$ inch to $\frac{1}{2}$ inch.

If the hooks do not get knocked off the gaffe it will probably be due to the cylinder not getting close enough to the needles.

In any of the common faults such as mis-lifting and cards jumping off the cylinders may be found out by a careful examination of the cards, whenever any of these defects occur, the needle points must be blackened with black oil or grease, and the card on the cylinder brought carefully to the needle points and allowed to remain for a few moments, then the cylinder is reversed and a careful examination of the card made, where if any of the following defects are found, the results will be as indicated, and the cylinder regulated accordingly. Figs 44.

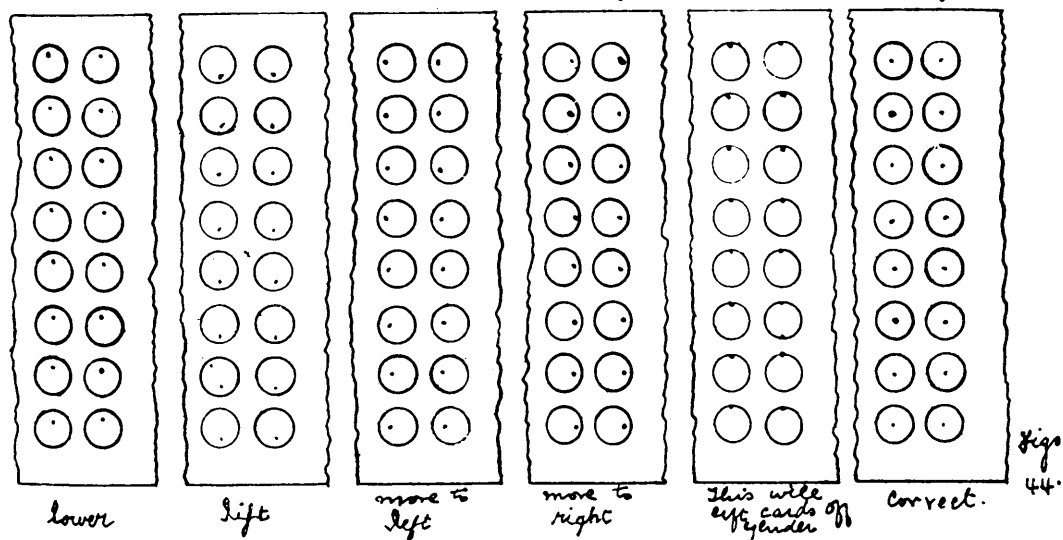

Regulating screws are provided in all Jacquards for raising or lowering or moving the cylinder to the right or left. an examination of the card will indicate what must be done.

To prevent cards wrapping the cylinder a cord is passed over the cylinder and the roller as shown in Fig. 45.

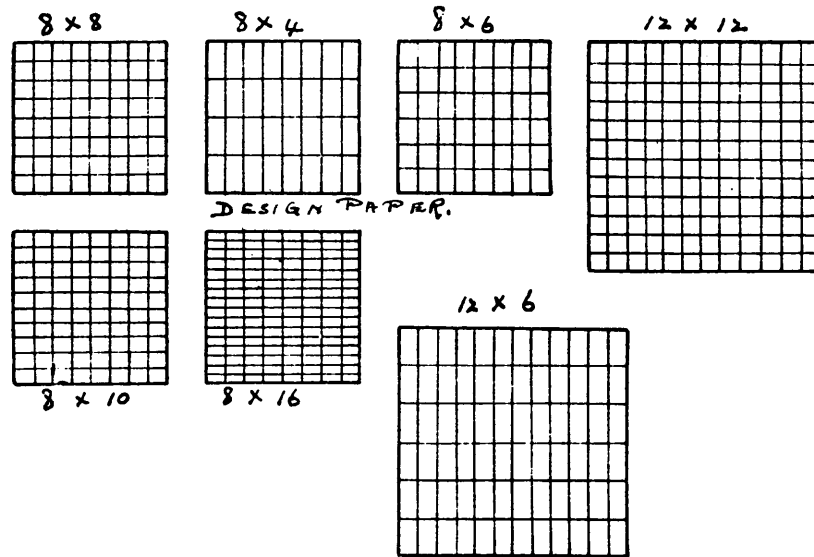

Fig. 45.

Design or Point paper is ruled in squares in proportion to the ends and picks in the woven design, the ruling threads way, will be the same number of squares between the thick lines, as there are needles in one row of the Jacquard used. In weaving a cloth on a 400 Jacquard with 8 needles in a row, and 100 ends and picks per inch in the cloth, the design must be painted up on "point" paper 8 by 8. So that the pattern will be in proportion, when 400 picks have been inserted a pattern four inches long and four inches wide will have been woven. If on the other hand a cloth with 100 ends and 50 picks per inch is required, the design must be painted up square on design paper 8 by 4 and the full width of 400 ends on design paper will be the same as 200 picks on design paper, when 200 picks have been inserted a pattern of cloth four inches square will have been woven, so that in selecting the design paper for a Jacquard 8 needles in a row, the reed may be said to equal 8, namely the number of squares between the thick lines (bars) threads way of the design paper and the rulings picks way will be in proportion to the picks, thus a cloth is required 100 ends and 50 picks per inch, the design paper to use will be $100 \div 8$ therefore 50 equals $\frac{8 \times 50}{100} = 4$, therefore paper to use 8 by 4. If a cloth is required 70 ends and 60 picks per inch:

$70 \div 8$ therefore 60 $\div \frac{8 \times 60}{70} = 7$ nearly, paper to use 8 by 7.
 In a cloth 80 ends and 60 picks per inch, $80 \div 8$, therefore $6 \div \frac{8 \times 60}{80} = 6$ paper to use 8 by 6.

In a 600 Jacquard with 12 needles in a row, design paper 12 by 12 must be used for a cloth with the same number of ends and picks per inch, with more or less picks the ruling must be in proportion.



Casting out. If a pattern is woven in a jacquard tied up to a 100 need and it is required to weave the same cloth in a 80 need and the pattern to come out square, then a portion of the harness must be cast. To find the number of hooks to use $\frac{400 \times 80}{100} = 320$, therefore $400 - 320 = 80$ hooks to cast out. The design will therefore be painted up on 320 ends and 320 picks on design paper. As 80 hooks have to be cast out, this equals 10 rows of 8 needles in a row, a selecting card is made with the following rows of 8 holes in a row cut. 3.8. 13. 18. 23. 28. 33. 38. 43. 48. This card is put up at the jacquard and the portion of harness is lifted as indicated by the holes, the warp is then cut out of the lifted harness and the rest of the warp "sleyed" into a 80 need. The selecting card is then put up at the Card cutting machine along with the design and as the knot travels over the card, the card cutter misses the rows of holes so that the design is cut only for those hooks which are working the harness.

Structure of Diapers, Damasks and Brocades, with designs.







Diaper Patterns are designs with a twill or satin basis, and are generally woven on a few number of healds compared with the number of ends and picks in one repeat of the pattern, the increased size of pattern being obtained by the method of drawing the ends through the healds. Twill diapers are such as have a three and one twill basis and as illustrated in Figs. 46 . 47. an example of a satin diaper is given in Fig. 48 and in all these and similar examples a filled in square of the warp weave must come opposite to a blank square of a weft weave, this gives a clear line of demarcation and shows the two weaves up to the best advantage; Figs 49 . 50 gives the block plans for Figs 47 . 48. respectively. in these block plans each filled in square represents one repeat of the weave thus  represents  or  and  represents  or 

Fig. 51 gives a block weave for a bordered serviette, work the same up on design paper in a five end satin weave. These cloths are woven in cotton and linen to varied particulars say

64 Reed 64 picks per 1" 20^s warp 20^s weft.

Damasks are cloths with a satin basis the figure may be in warp or weft satin weave and the ground in the opposite weave, thus a warp satin figure may be developed on a weft satin ground and vice versa. Fig. 52 gives a design suitable for the border of a tablecloth and Fig. 53 shows the same worked up on design paper just sufficient of the work being done to show how the full design may be completed.

Damask cloths with an equal number of ends and picks per inch and made from the counts and materials in warp and weft are reversible. In one sided damasks the quality of one of the fibres is better than the other thus a cotton warp ground and a weft linen figure, or any inferior kind of material for the warp to that of the weft as worsted or silk weft and a cotton warp or wool weft and linen warp. The particulars are varied but for a good ordinary linen table cloth say 72 Reed 72 Picks per 1" warp 36^s weft 16^s
 = cotton counts. Cotton counts.

A low quality of damask table cloths are often woven entirely of cotton, both in grey and colour. The length of staple in the fibre easily determines whether the material is linen or cotton.

Brocades. The term brocade when applied to cotton fabrics is generally understood to be a figured cloth with one warp and one weft; the difference between Damasks and Brocades is that in damasks the figure and ground is in opposite satin weaves, whereas in brocades the figure may be developed in a variety of weaves, and the ground may be plain, twill satin, mock leno or any small weave which repeats into the number of ends and picks in one repeat of the pattern. Fig. 54 gives a suitable brocade design and Fig. 55 shows a portion of it worked up on design paper. The particulars for a brocade are

100 Reed 100 Picks per 1" 80^s warp 80^s weft

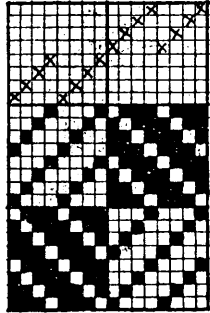

Fig. 46

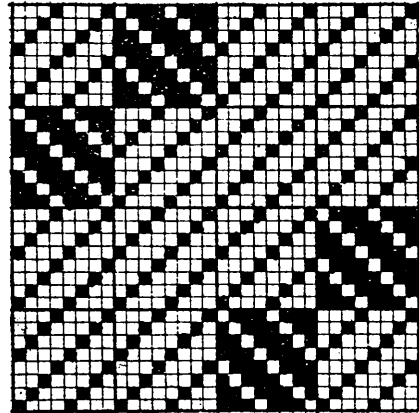

Fig. 47

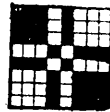

Fig. 50

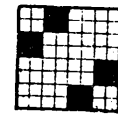
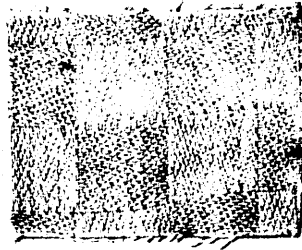

Fig. 49

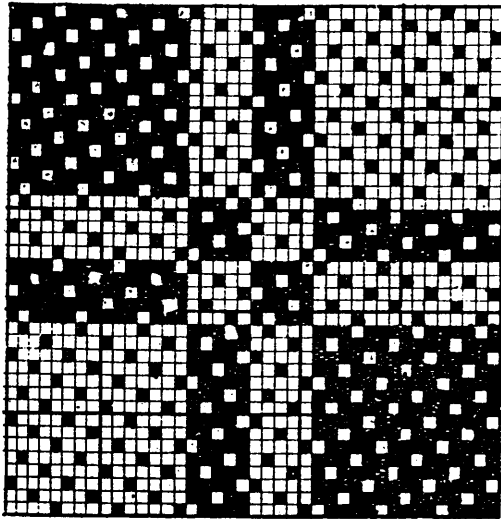

Fig. 48

JRJE

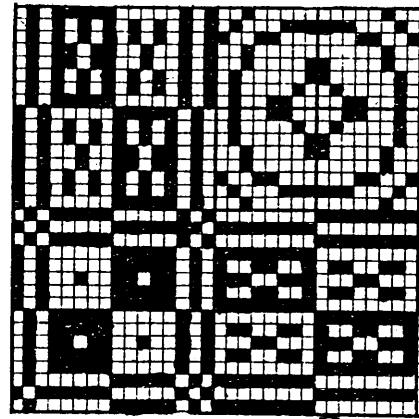

Fig. 51

SB.11

42

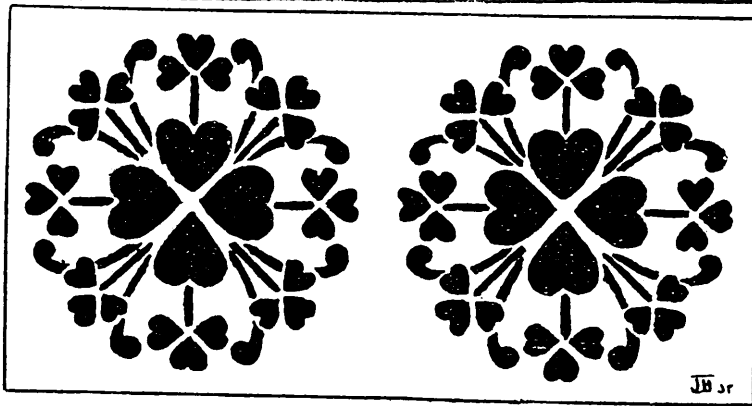

Fig. 53

Fig. 52

JB sr

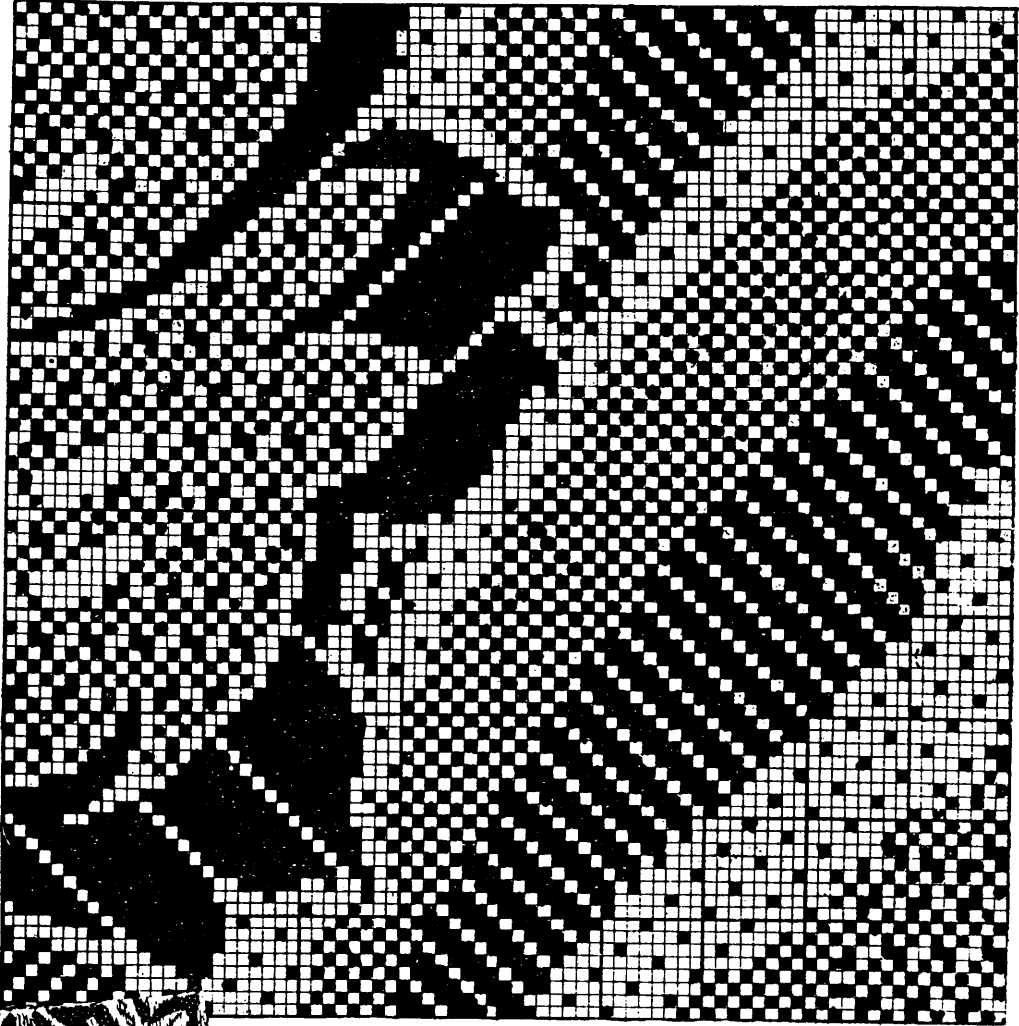

Fig. 55

Fig. 54



Jacquards for Special purposes.

Bannister or Split harness. Fig. 56

The object of this tie-up is to increase the pattern producing power of the Jacquard, with a 200 machine a pattern can be made which will repeat on 400 ends. The tie-up is straight with this addition, there are 16 holes in one row of the comb board, the harness passing through 1 and 2 are tied together a few inches above the comb board, there is a loop through each lease of the harness and passing through these loops are 16 thin staves of wood or metal about $\frac{1}{8}$ " inch thick and $\frac{1}{2}$ ins. deep. The staves are connected to 16 spare hooks of the Jacquard, any pattern of a small figuring effect can be woven for ground, so that it does not interfere with the lifting of the binding for figure, for when one of the staves is lifted $\frac{1}{16}$ " of the warp is lifted, if the rest of the cards are cut for figure, the hooks operated by that portion of the card work the figure and the staves the ground weave, mails B.C shows harness lifted by Jacquard hook for figure and mails D.E lifted by staves for ground. Special care is required in designing the ground weave, so that when the staves lift in the figure part of the design they will not lift ends which are being left down for binding. In Figs 57, 58 filled in squares represent ground weave and the X's indicate possible binding points where the warp may be left down to bind figure, this is shown in Fig. 59 which represents the weave in the cloth and the figure weave moving in steps of two. Fig 60 illustrates how Fig. 59 is placed on design paper for Card Cutter.

Pressure Harness. Fig. 61.

The capacity of a 400 Jacquard, straight tie, is limited to a pattern which stands on 400 ends in one repeat, by the aid of pressure harness the pattern may be increased to

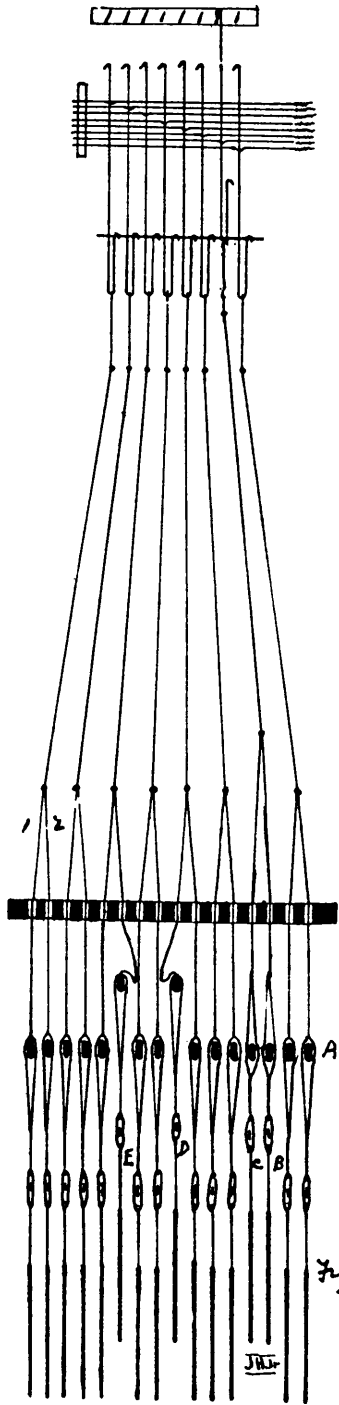

Fig. 56

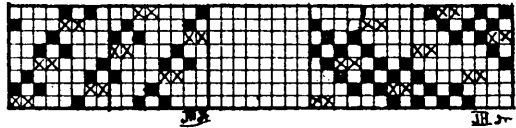

Fig. 58

Fig. 57

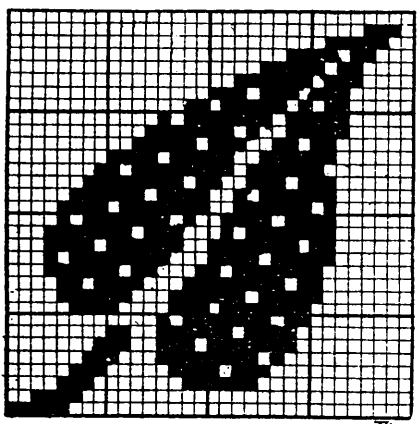

Fig. 60

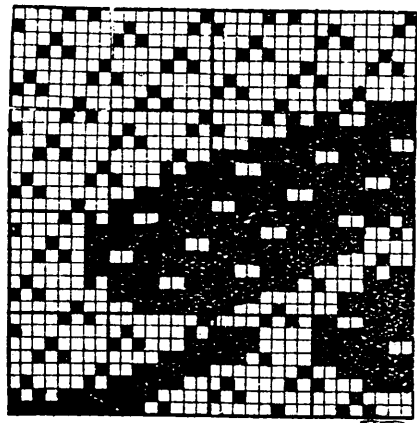

Fig. 59

46.

2000 ends and more. The class of cloths woven on these machines are known as Damasks, they generally have a warp satin figure and a weft satin ground or vice versa. The figure may be either twill or satin, but the ground will be in the same class of weave, say the ground is in weft satin the figure will be in warp satin. Healds are placed in front of the harness; if a pattern is required with a five end satin ground, 5 healds will be used, these healds have mail eyes about $2\frac{1}{2}$ ins. long; the ends are drawn through the harness 5 ends through one mail, these are then drawn through the healds single, one end through each of the eyes of the separate healds. The pattern is painted up solid with no ground weave Fig. 62. The healds are worked over in satin order and in the working they assume three different positions.

1st when they are stationary A, with the eyes in a position so that a shed can be formed by the Jacquard. 2nd when they are down B with the top of the eye on a line with the bottom shed. 3rd C, when they are up with the bottom of the eye on a line with the top shed. When using 5 healds three of them are always in the first position, when a mail eye of the Jacquard harness goes up to form figure, one of the five threads is brought to the bottom by the healds and a warp satin cloth is the result, if all the harness is left down on each pick, one thread out of each 5 is taken up by the healds and a weft satin cloth is produced; so that by lifting the harness to produce a figure, a warp satin figure is produced by the harness and healds combined and that part of the warp left down by the harness one fifth of it is lifted by the healds on each pick producing a weft satin ground. Fig 63 shows a part of Fig. 62 as it appears in the cloth it will be seen to go in steps of five. Fig. 64 shows binding points x^s heald down for binding figure and ■^s a heald up for binding ground.

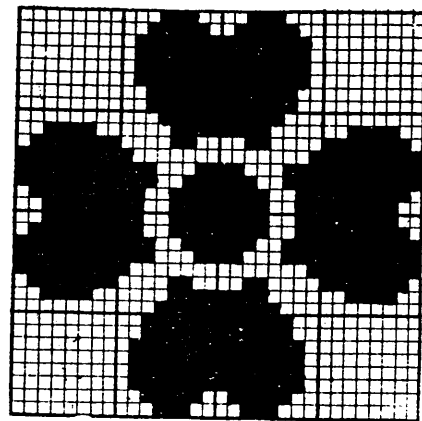
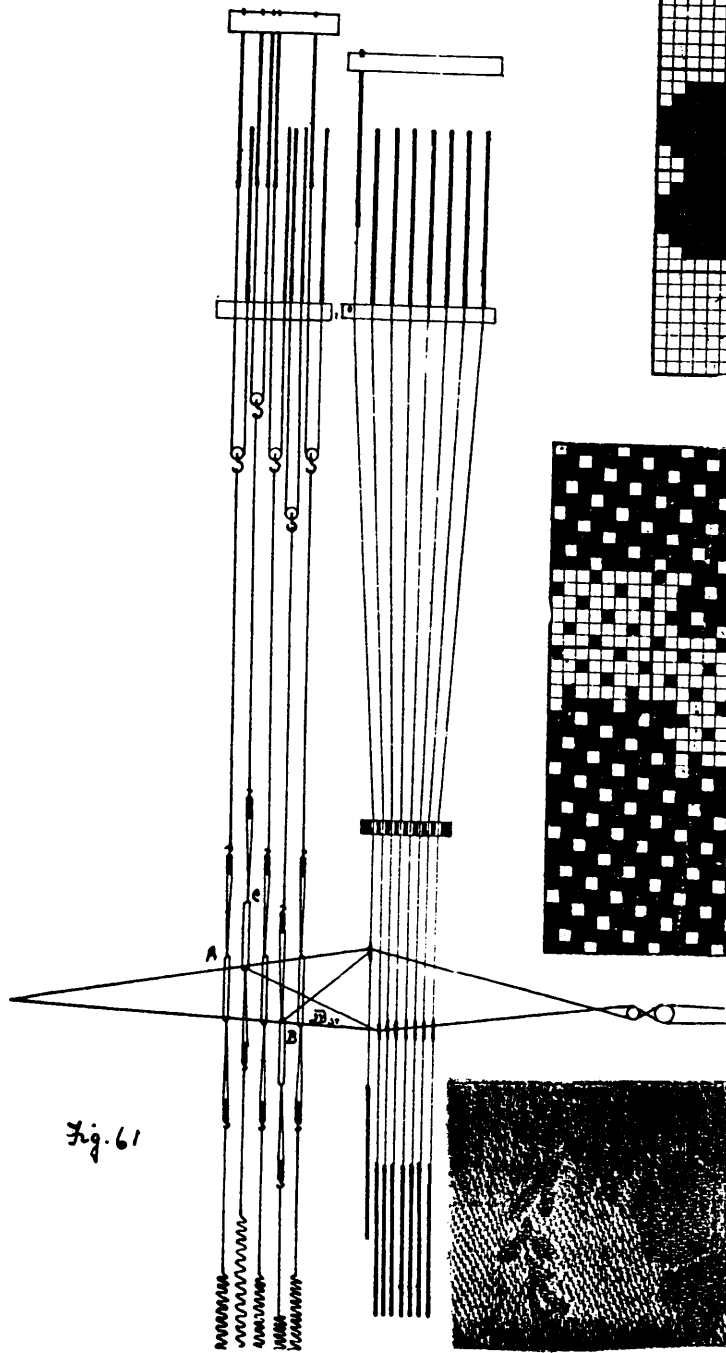

Fig. 62

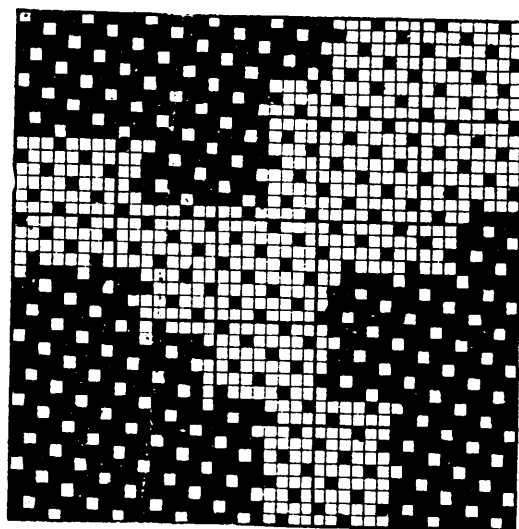

Fig. 63



Fig. 64

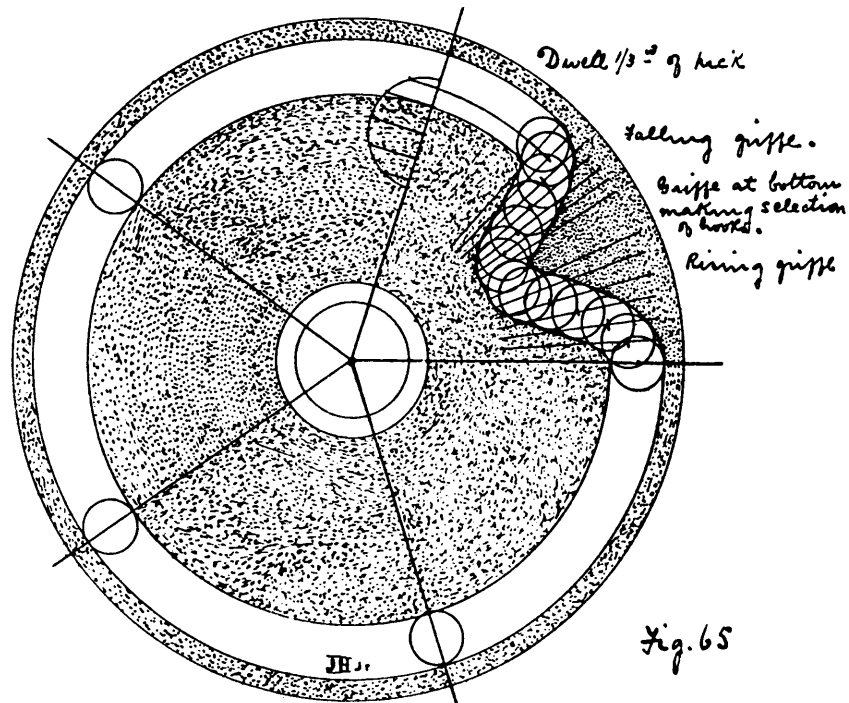

Fig. 65

Machine lift. In the weaving of Damasks where one card serves for five picks, the healds being worked over in satin order before another shed is made by the Jacquard, a special form of tappet, either positive or negative, to work the giffe of the Jacquard is required. Fig. 65 illustrates the construction of a tappet to work the giffe of a Jacquard to remain up for 5 picks, to the following particulars and scale given. nearest point of contact 4 ins. stroke 3 ins, treadle bowl $\frac{1}{2}$ ins diameter, dwell $\frac{1}{3}$ rd of a pick. Make the usual circles as in a shedding tappet, take $\frac{2}{3}$ rd of a pick for change and divide it into 12 parts, take 6 of these for the rising giffe, 2 parts for dwell at the bottom to make a fresh selection of hooks, and 4 parts for the falling giffe, divide space A.B into 6 parts for the falling giffe, divide C.D into 6 parts for rising giffe, divide these lines by arcs of circles and place treadle bowls at points of intersection, the inner lines gives the shape of the tappet, the outer line makes the tappet positive

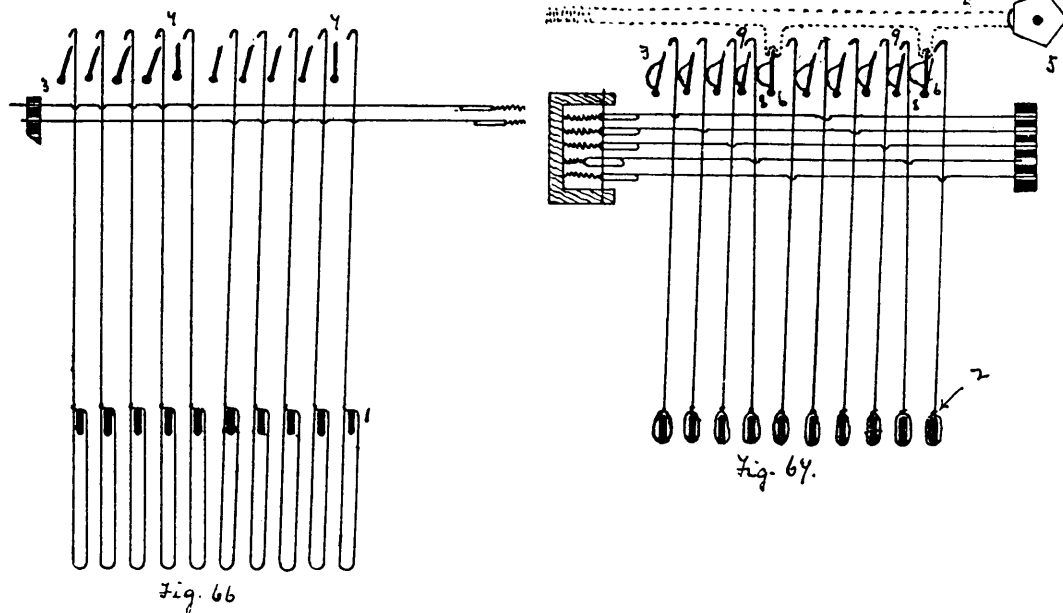
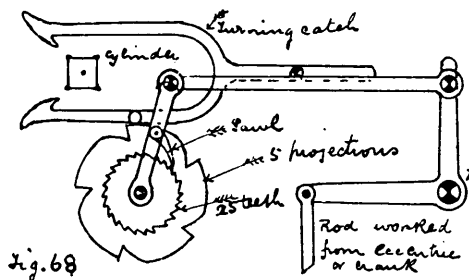

Fig. 66

Fig. 67.

Twilling Jacquard. The disadvantages of Pressure harness is the crossing of the yarn between the heads and the harness, this action puts strain on the warp ends, to overcome the difficulty two or three machines have been introduced which dispense with the heads, and perform the work by aid of the Jacquard hooks only, the principle underlying these machines, is that one needle controls 2, 3, 4 or 5 hooks, depending upon the ground weave pattern. Figs 66 and 67 illustrates the principle of working of the Beesbrook Twilling Jacquard, 5 hooks are shown controlled by one needle, each row of hooks rest on a bar 1, which extends from one side of the machine to the other, the ends of the bars at each side rest in the loops of very strong hooks 2, the griffe bars 3 are movable on a fulcrum, resting over the griffe are a number of flat rods 4 with notches on the underside, the griffe bars fit into these notches, resting

50 against one end of the flat rods is a cylinder 5 provided with projections to push back the flat rods, a strong spring and collar on the end of the rod presses it back when the projection on the cylinder ceases to act. when one of the flat rods is pushed back as shown in Fig 64 the gripe bars 6 and 6 are placed in a vertical position and leaves down rows of hooks 7 and 7 Fig. 66 which would otherwise have been lifted, and the full side 8 of the gripe 8 pushes on to the gripe in front the strong hooks 9 which otherwise would have been left down, this hook and a similar one at the other side of the machine are taken up by the gripe and a row of hooks are lifted which otherwise would have been left down.



The pattern is painted up solid without binding or ground weave the same as in Pressure harness, and one card serves for five picks for a 5 end satin figure and ground. Fig. 68 illustrates the method used, to allow the top catch to drop down and engage with the cylinder every five picks.

Brocade harness arranged to increase the size of the pattern. Fig. 69 illustrates the method of tying up the harness of an ordinary double lift Jacquard whereby the size of the pattern is doubled. In the ordinary double lift machine the two hooks controlled by the same needle are joined by a neck cord, in this case each hook is attached to a separate harness thread and controls one end

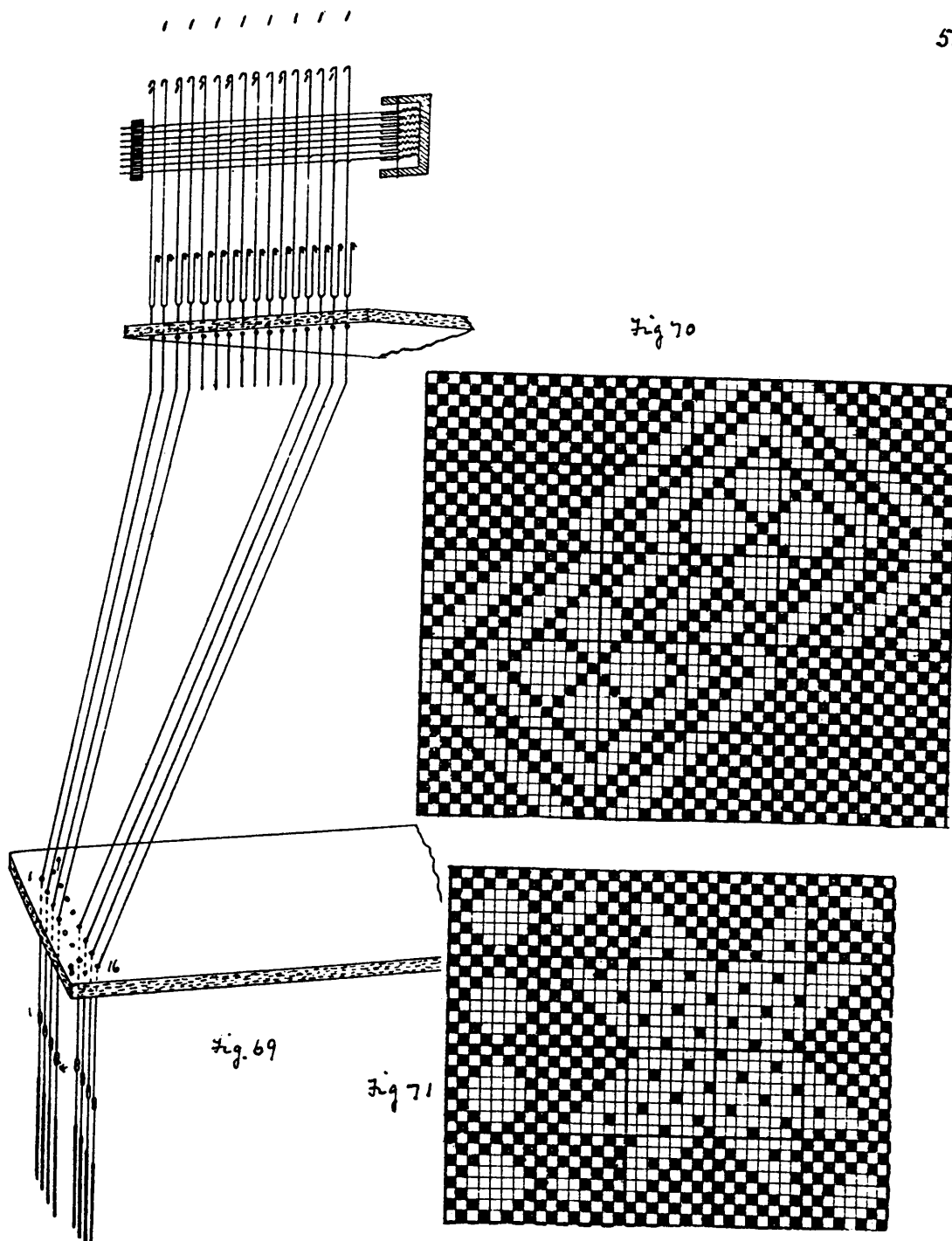

Fig 70

Fig. 69

Fig 71

by this means a 400 machine controls 800 ends. If cards are put up with all the holes cut, every other end will be lifted each pick and plain cloth woven. The figure is developed in weft by leaving hooks down. Fig. 70 gives a prepared design, everything must be painted on the tab i.e. plain order as two consecutive ends cannot be lifted on the same pick, and an end cannot be lifted for two picks in succession. The card cutter's instructions will be on odd picks deal with odd numbered ends, on even picks deal with even numbered ends, to keep the cutter to do this, the design is divided into squares of 16 to the bar, the reading of the first pick for the design Fig. 70 commencing at the right hand side will be. cut 4. Miss 1. cut 2. Miss 1. cut 5. cut 8. Fig. 71 gives another design.

Setting out, building and dressing Jacquard harnesses.

Fig. 72 gives a sketch of a complete leash of a Jacquard harness from the hook to the lingot and a 400 Jacquard tied up straight tie will consist of 400 similar leashes attached to the 400 hooks of the Jacquard, one leash to each hook respectively. If the harness is tied up to suit a 30 reed and weaving cloth 30 inches wide in the reed, there will be 2400 ends and 2400 divided by 400 hooks gives six complete patterns in the width, there will therefore be six leashes tied to each hook.

Before commencing to build the Jacquard, the top couplings are attached to the mail eyes, as also are the bottom couplings and lingots. This work of preparing the couplings is shown in Fig. 73. a number of mails are threaded on to a thin wire, the waxed end of the turnie from the bobbin is passed through the holes in the lower part of the mails, and also through the holes in the top of the mails, the ends of the turnie are then fastened to the pegs 11. and 2 respectively, then by means of

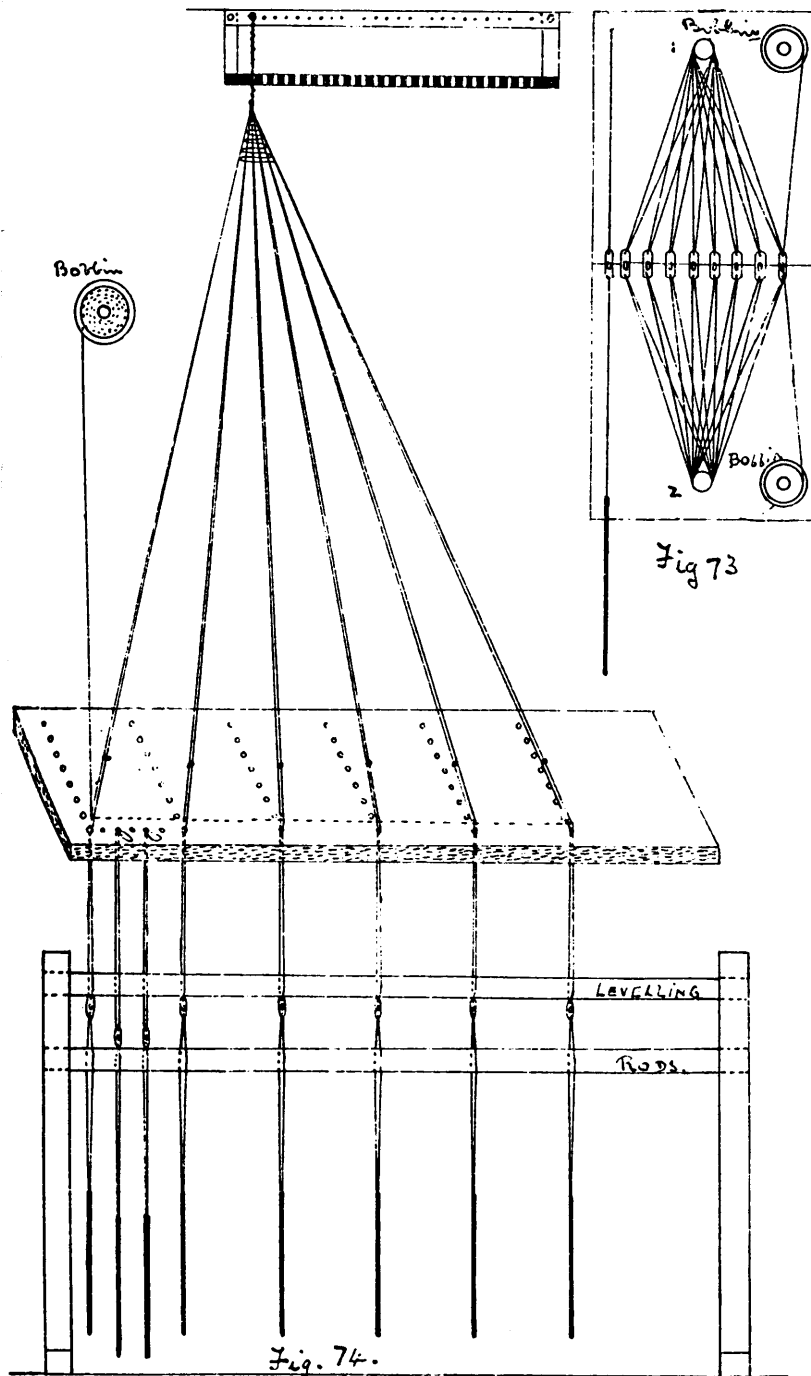

Fig. 74.

Fig. 72

Fig. 73

54.

a small hook, the turn between one mail and the next is looped over the pegs, commencing at a point farthest from the bobbin in each case, the yarn is then cut at the pegs and a knot tied at the end of each pair of threads, in the lower coupling the lings is threaded on before tying. These couplings are then threaded on iron levelling bars and fixed in the harness building frame Fig. 74 the bars are levelled so as to have all the mail eyes on the same straight line, the top couplings are then drawn through the holes in the comb board, the turn from the bobbin is passed through all the couplings required for the same hook and the loops between the couplings are taken up to the same pin and tied up as one and this lot of leashes are tied up to one hook of the Jacquard, in a 400 Jacquard 400 similar harness cords will be required one lot for each hook, these leashes of harness are then tied up to the neck cords which are attached to the hooks of the Jacquard, taking care that the same tension is maintained throughout so as to keep all the eyes level. Sometimes the lower couplings are tumbled before varnishing, in that case they are damped by a cloth dipped in water, and as they dry they take on a spiral twist, after each coupling has been separated from its fellow the harness receives two or more coats of varnish and after drying it is ready for the loom. Another system is to use a wire heald in the lower coupling, many firms are now doing this and they find it, in every way satisfactory.

Warp and Weft backed Cloths. Fabrics are sometimes backed with warp or weft, a separate weave being used for face and a separate weave for the back, the object of this arrangement in many cases is to make the cloth reversible as in heavy Tapestry hangings or for the purpose of serving as a lining, or a foundation upon which

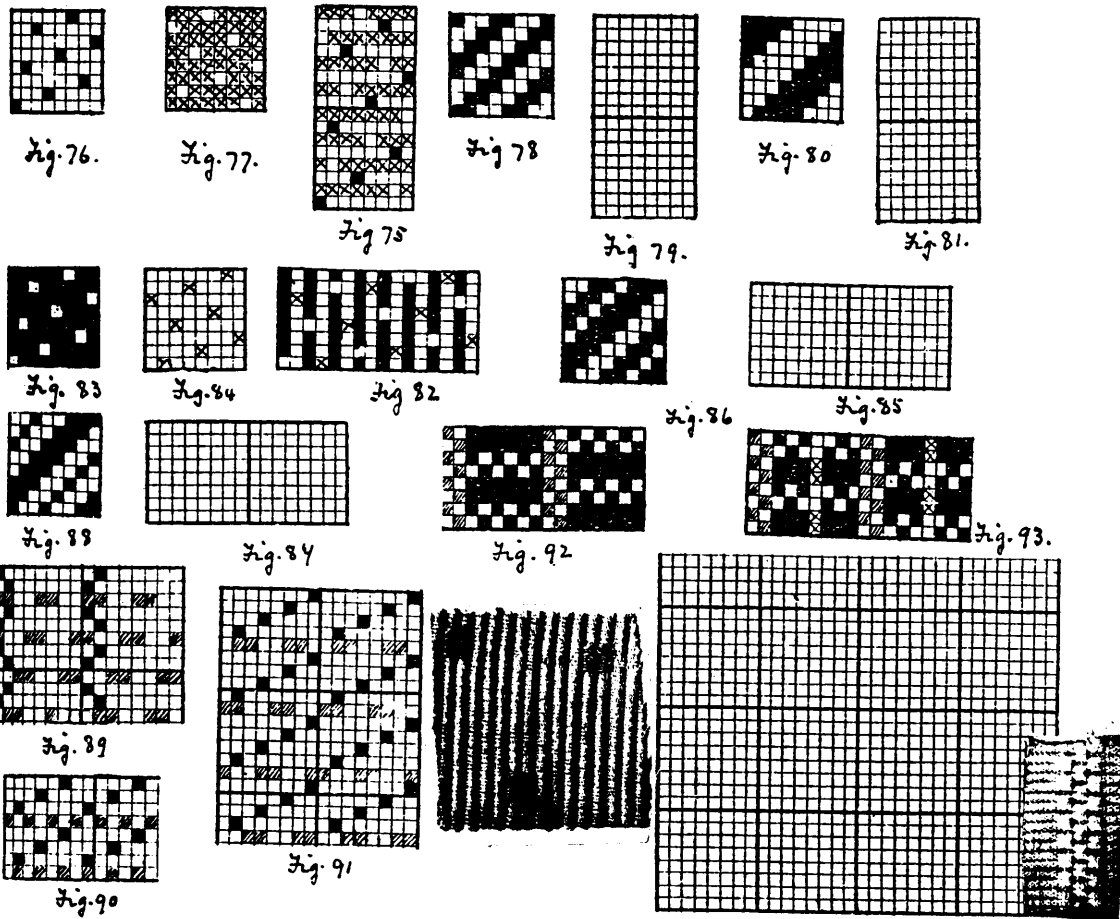

another cloth can be made as Trouserings, Vestings, Piques, Fustrans and Velvets. Bedford cords may also be included. Fig. 75 gives a pattern for a weft faced satin cloth, backed with a weft satin back. Fig. 76 and Fig. 77 gives the face and back weaves respectively. In placing the patterns on design paper, the face weave is filled in on alternate picks the intervening picks being afterwards filled in with the back weave. Take Fig. 78 and place it on design paper Fig. 79 and back it with an 8 end satin. Take Fig. 80 and back it with a 8 end twill on space Fig. 81. Warp backed Cloths are somewhat similar in construction to weft backed cloths, the threads being arranged end and end

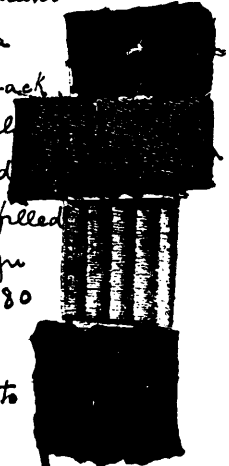

56 instead of the picks. Fig. 82 gives a warp satin face pattern backed with a warp satin weave, Fig. 83 being the face and Fig. 84 the back weave. On the space Fig. 85 place the pattern Fig. 86 and back it with an eight end twill 7 and 1. On the space Fig. 87 place the pattern Fig. 88 and back it with an 8 end satin. Fig. 89 gives an example of a Fustian pattern with a 2 and 2 twill back, with two pile picks to one back pick. Fig. 90 gives a 5 weft float velvet with a plain back and Fig. 91 gives a 7 weft float velvet with a 2 and 2 twill back. Fig. 92 gives the design for a Bedford cord without hudding ends and Fig. 93 gives the design for a Bedford cord with hudding ends.

Piques These cloths are made with a plain face weave and the figured effect of the pattern is produced by using a back warp and bringing it up into the face cloth for figuring only the back warp is on a separate beam and being heavily weighted, it tends to pull down the face cloth, producing a figure on the face of the cloth in the order that the back ends have been lifted. The effect is somewhat similar to what would be produced by using a needle and thread and tightly stitching the cloth to suit some figured effect. The cloths are generally made 2 face ends to 1 back end. Fig. 94 gives the motive or the effect it is desired to produce in a pattern. Fig. 95 shows the same pattern, each end being lifted for two picks in succession and Fig. 96 shows the pattern as it would be in the cloth, arranged two face ends \square weaving beam and one back end, the \circ^s indicate wadding picks, the insertion of which, between the face cloth and the back warp makes the figure stand out more prominent.

Another type of pique is when the wadding picks are not pulled out of the straight but interweave on some picks with the back warp such an example is given in Fig. 97 the arrangement

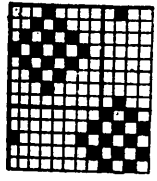

Fig. 94

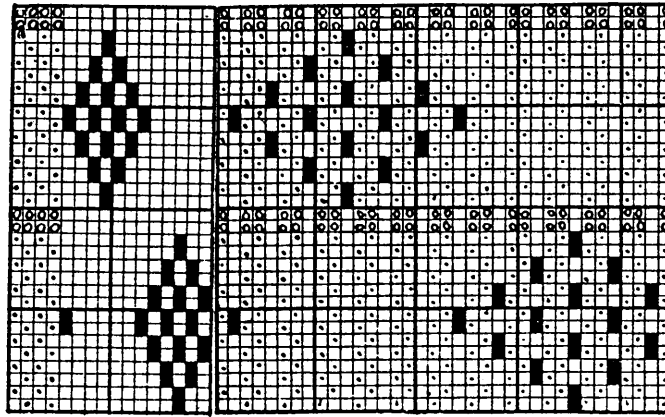

Fig. 95

Fig. 96

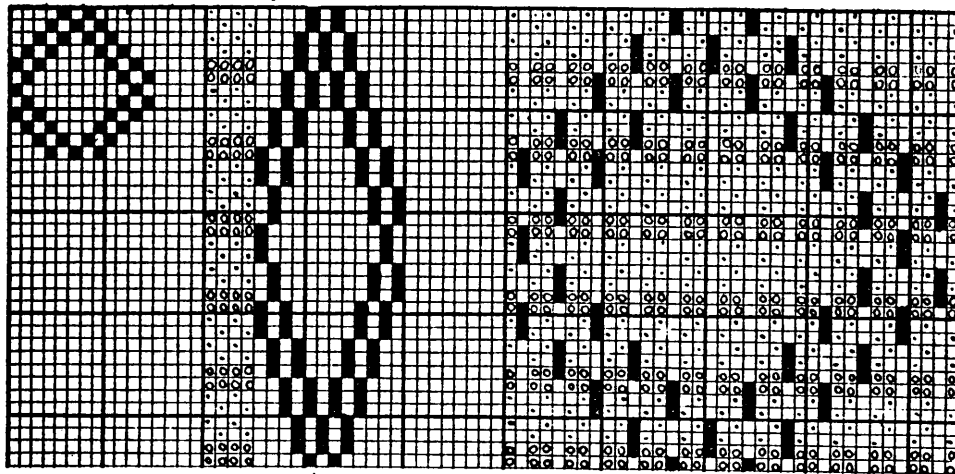
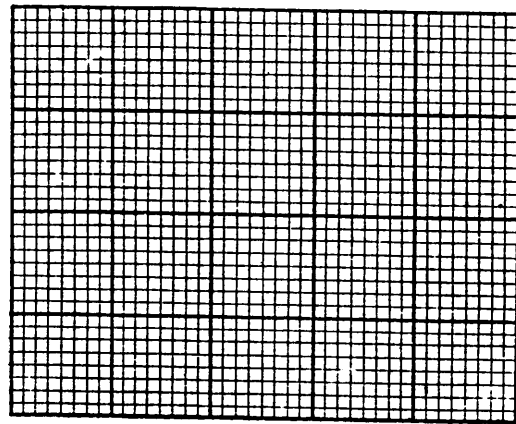
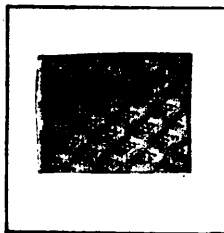

Fig. 97



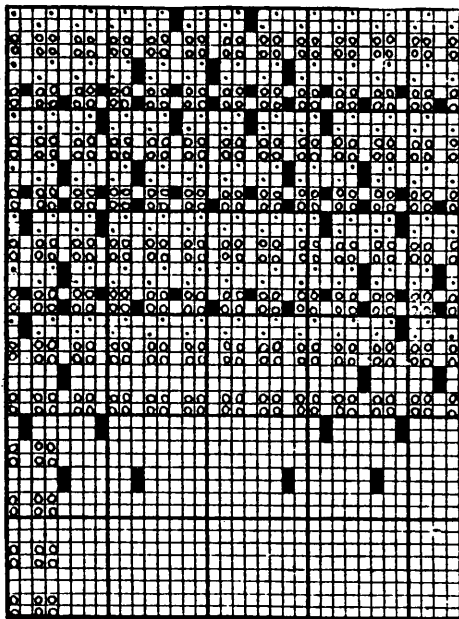

Fig. 98

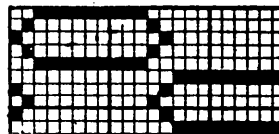

Fig 99

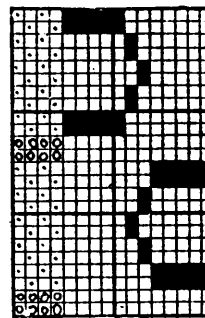

Fig 100

being four face picks two wadding picks, the back warp when not used for figuring is floating loosely behind the cloth and is known as a loose back hique. Fig. 98 shows the same design arranged in picks 2 face 2 wadding, 2 face 2 back, it will be seen that on back picks, the face warp is lifted and that the back ends are weaving in plain order with the back weft, which may be the same counts as the face weft, the wadding weft will probably be of coarser counts.

A number of peg plans and loomings drafts are given suitable for a 16 shaft dobby, with four heads for weaving plain and twelve heads for back warp Figs to Fig.

Fig. 99 is the motive for Fig. 100. Fig. 101 is the motive for Fig. 102. Fig. 103 is the motive for Fig. 104. The warp for the plain cloth is drawn on the front four shafts and the back warp on the twelve shafts behind. Fig. 105 gives the loomings of back warp to suit peg plan 102 and Fig. 106 gives the loomings for the back warp for the peg plan 100. and 104 for 103. The back ends

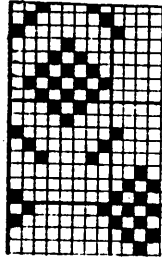

Fig. 101.

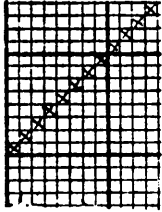

Fig. 105

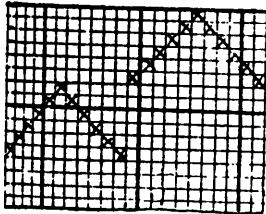

Fig. 106

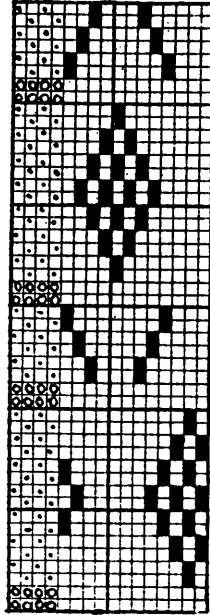

Fig. 102

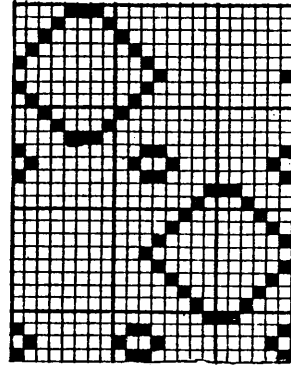

Fig. 103

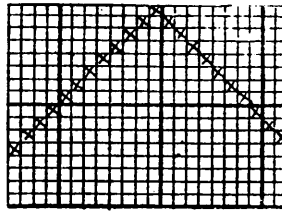

Fig. 104

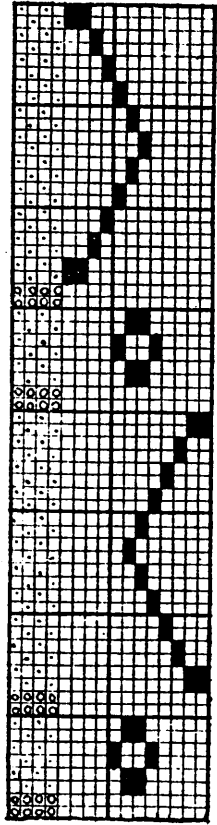
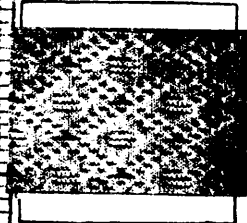
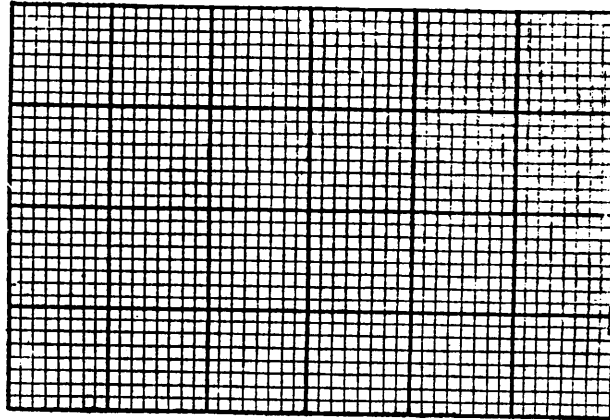
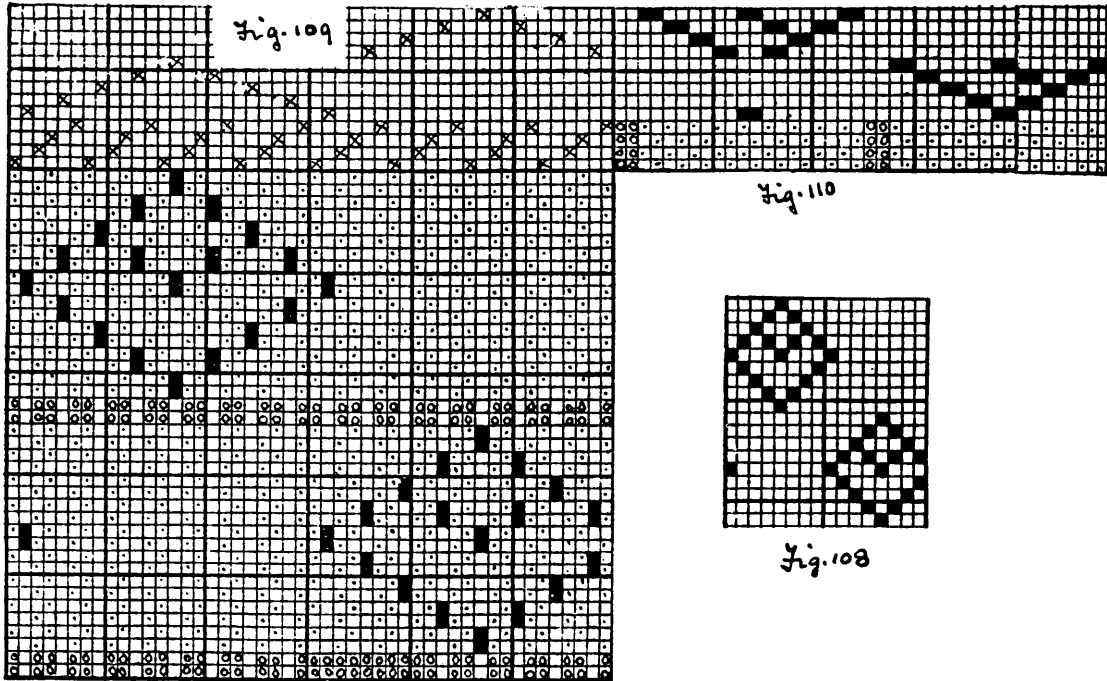

Fig. 104



alternate with the ends from the front four beads wearing plain in the order of 2 face ends to 1 back with three ends in one dent, and the back end in the middle of two face ends.



Figs 108, 109 and 110 gives the motive, design and loomings, and heq plan respectively for a piece cloth.

Jacquard for weaving Toilet Cloths Fig. 111 illustrates the tie-up of a Jacquard, with four healds placed in front of the hammers, the tie up is suitable for the style of pattern given in Fig 94 where the face ends are weaving plain by the healds and lifted on wadding picks; the back ends are lifted into the face by the Jacquard, the loomings draft being one end back through harness and two ends face, through healds. It will be seen that the back warp when not lifted into the face cloth floats loosely behind and in large patterns this would be a great drawback, to meet the difficulty the back warp is allowed to weave in plain order as shown in Fig. to enable this to be done the comber board is made in two parts with the harness knotted above the comber board, shown in section Fig. 98 by lifting the whole of the face warp by the healds and

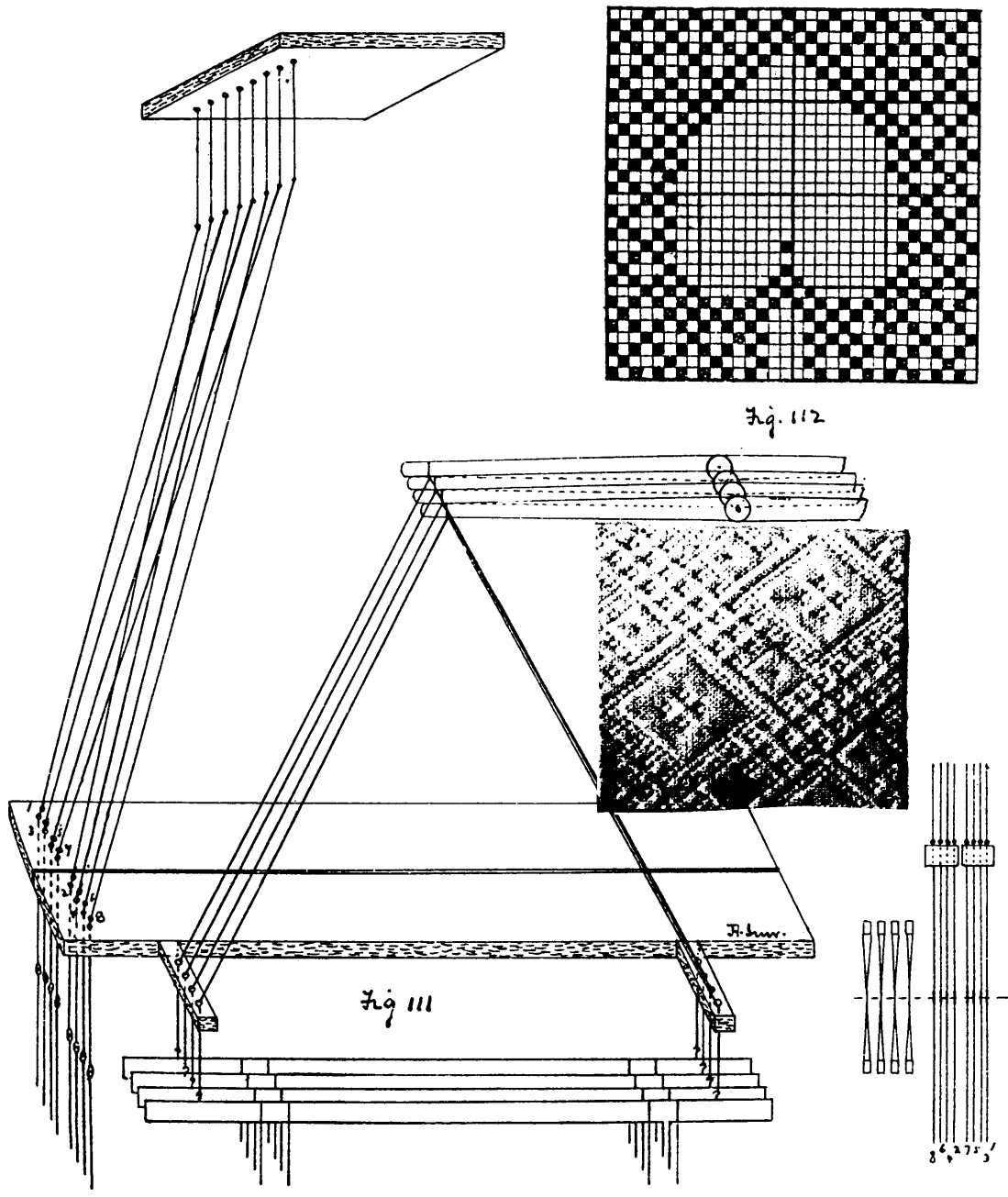

A small portion of a Jacquard pattern painted up on design paper, ready for the card cutter is shown in Fig. 112 it will be seen that all round the outline of the figure the ends lift in plain order, and that the whole of the design is developed on the plain weave. Each card serves for two or more picks depending upon whether the cloth is a loose back as in Fig. 97 or a fast back as in Fig. 98

When Wadding picks are used this yarn is usually of coarser counts than the weft for the face cloth, a changing shuttle box motion will therefore be required, for a heavy cloth of this character the Ecceles Drop Box Motion (Bowburn's & Peck's patent) is suitable and as it is a four shuttle box motion extra coloured weft can be introduced. This is a positive drop box motion capable of moving the boxes from 1 to 2; 1 to 3 or 1 to 4, it is worked on the principle of a double eccentric and a crank. Fig. 113 illustrates the principle parts of the motion. 1 is the bottom shaft of the loom; 2 a tappet fixed to the end of 1; 3, 4 a short arm fixed to 2; 5 a rod connected to 3, 4, the other end of which is connected to the end of the upright rack 6, it is also connected with the lever 7 with its fulcrum at 8, at the other end of 8 is a short arm 9 provided with a pin or stud which engages with the notches in the star wheel 10 and turns the card cylinder 11; 12 is a small pinion fixed to one of two discs; 13 a catch which engages with the notches in the disc when the boxes are stationary; 13 a rod connected with the discs; the lever 14 and the upright rod 15 connect 13 with the boxes. There are three needles or feelers 16 situated one behind the other, one for each of the two upright racks 6 and one for the catch 13. The tappet 2 moves the cylinder 11 to the needles 16 once every two picks, if there are perforations in the card for the points of the three needles to pass through the racks 6 fall

Cowburn & Pecks Drop Skip-Box Motion.

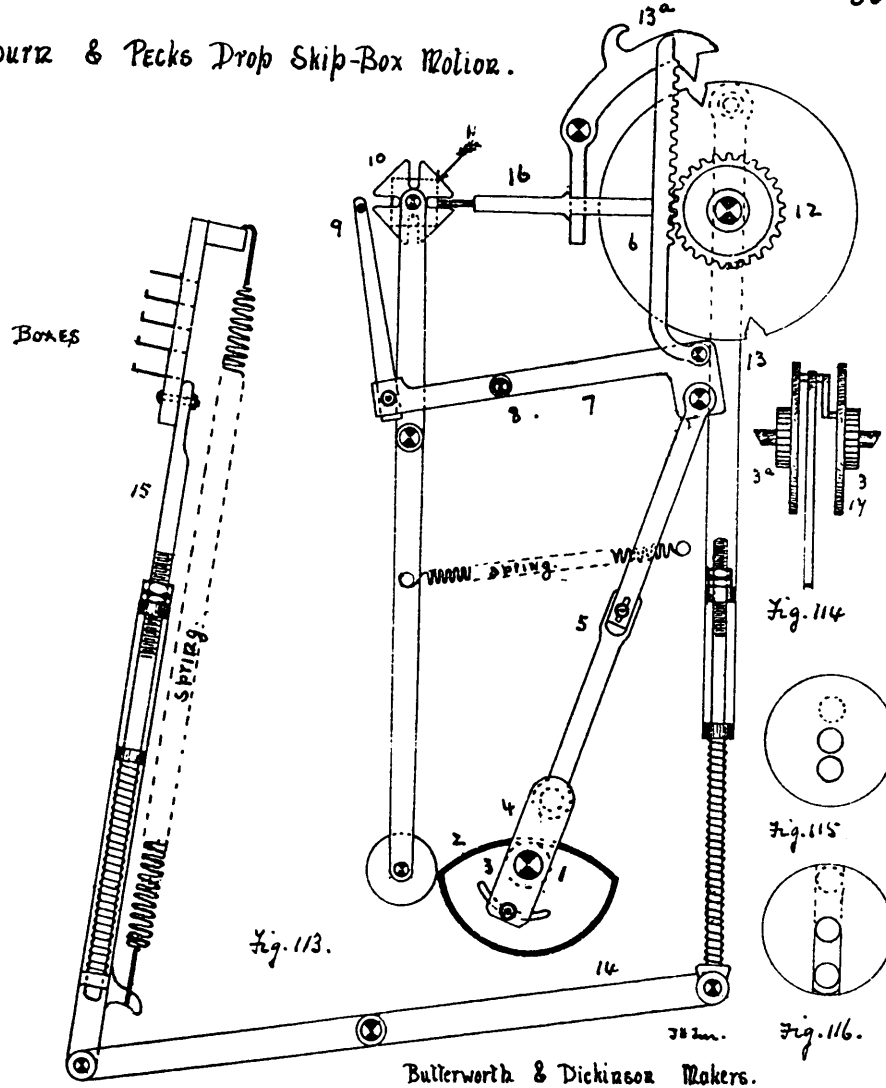

Fig. 113.

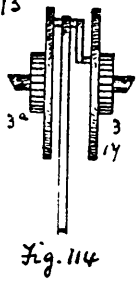

Fig. 114.

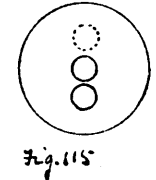

Fig. 115.

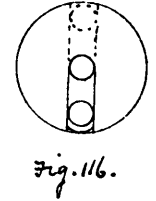

Fig. 116.

Butterworth & Dickinson Makers.

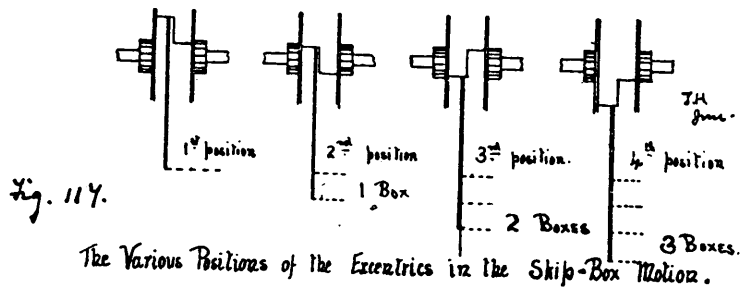

Fig. 117.

The Various Positions of the Eccentrics in the Skip-Box Motion.

6 4 away from the pinion by their own weight and no changes takes place, but if there are two blanks and one perforation, the catch 13 will be lifted by one of the feelers forcing it back, 6 will be pressed into gear with pinion 12 by another of the feelers, then the downward movement of the arm 3. 4 due to the revolving of 1 will bring down the rod 5 and the rack 6 which turns the disc 14, bringing down the rod 13 and lifting the boxes. Fig 114 gives an end view of the discs and rod 13 when the disc 14 is turned by the pinion 3. 13 is lowered to the extent of 2 boxes, when 14^a is turned by 3^a the rod 13 is lowered to the extent of 1 box. Figs 115 or 116 gives views of the two discs, and Fig 117 shows the various positions of the discs and eccentric when moving from the 1st to the 4th box.

Double Cloths. In the making of double cloths, two separate warps and two separate wefts are used, they may be of two different colours, each colour of warp interweaving with its own colour of weft or they may be the same colour. If two colours of weft are used, a changing shuttle box is required, if only one colour of weft is used an ordinary one shuttle loom will suffice. The two cloths may be the same or different weaves, they may be each separate from the other, binding only at the selvege, they may be bound at each selvege and form a tube or bag, or they may be bound together all over the fabric and form one solid cloth with the same or different patterns for the face and back. In placing the pattern on design paper, put down each pattern separately, namely, the weaves for the face and back cloths respectively; the patterns may then be combined together for the production of a double cloth, by keeping strictly to the following rules.

- ① Place the pattern for the face cloth on its own ends and picks ■.
- ② Place the pattern for the back cloth on its own ends and picks ▣.
- ③ Lift all face ends when a back pick goes in ▢



Fig. 124



Fig. 125



Fig. 118



Fig. 119



Fig. 121



Fig. 122

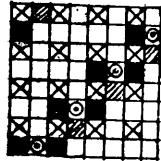

Fig. 126

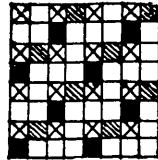

Fig. 120

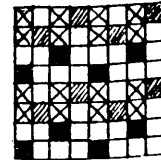

Fig. 123

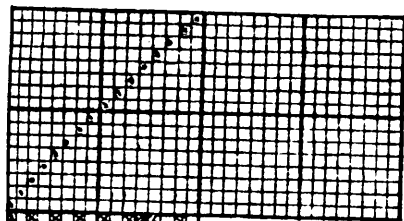
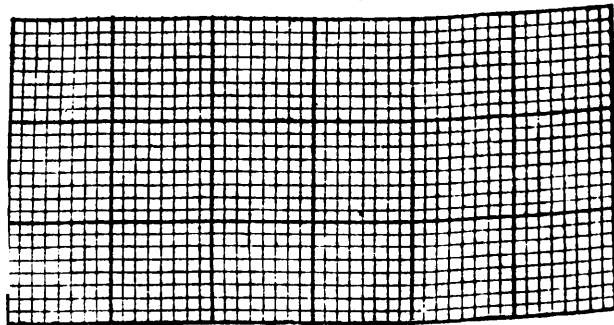
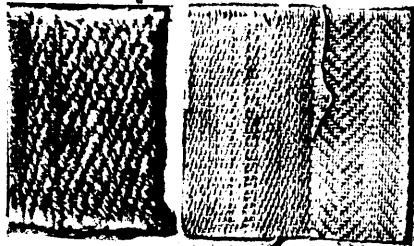

Fig. 130

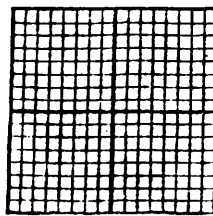

Fig. 136

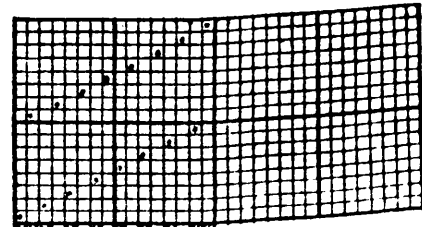

Fig. 133



Fig. 128

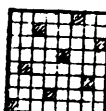

Fig. 129

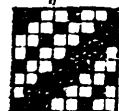

Fig. 134



Fig. 131

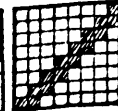

Fig. 132

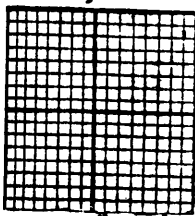

Fig. 139

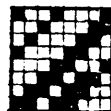

Fig. 137

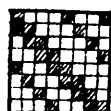

Fig. 138

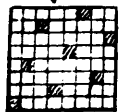

Fig. 135

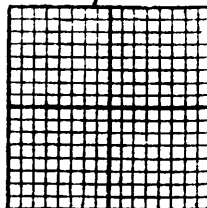

Fig. 142



Fig. 140



Fig. 141

④ If the two cloths have to be bound together, lift up a back end into a face pick, on end in such a position, that the threads situated on each side of it, and belonging to the face cloth are lifted at the same time, also if possible, let the back end be lifted immediately before or after the same end has been lifted to form the back cloth \odot - back ends into face cloth. Fig. 118 gives a pattern for a face cloth, Fig. 119 gives a pattern for the back cloth, Fig. 120 gives the two patterns combined 1 face 1 back in ends and picks, the resultant pattern is a double cloth in the form of a bag, binding at both selveges. Figs 121 & 122 give face and back cloths respectively, Fig. 123 shows the two cloths combined 1 end face 1 end back and 2 face 2 back in picks, the result is a double cloth to open out to double the width binding at one selvege only. Figs 124 and 125 gives face and back cloths respectively Fig. 126 shows the same combined 1 face 1 back in both ends and picks, the \odot 's indicate back ends lifted into the face cloth and binding the two cloths together to make a solid fabric.

Fig 128 and 129 gives face and back patterns respectively, Fig 130 shows the same combined, with looming on 16 shafts straight draft, give the peg plan. Figs. 131 and 132 gives face and back patterns respectively Fig. 133 shows the same combined, the looming is given the 1st 8 shafts for face and the back 8 shafts for the back cloth, give the peg plan. From Figs 134 & 135 make a bag on Fig. 136. From Figs 137 & 138 make a cloth (139) to open out to double width. From Figs 140 & 141 make a double cloth and bind together to form a solid fabric (142)

The terms two, three or four ply are often used to denote that two, three or four cloths are woven superimposed one upon the other Fig. 143 gives an example of a two ply cloth the number 1 being the upper and number 2 the lower cloth, the woven fabric will be in the form of a long tube

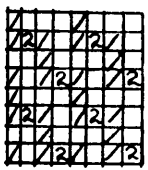

Fig. 143.

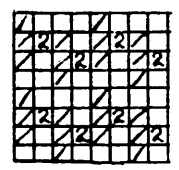

Fig. 144.

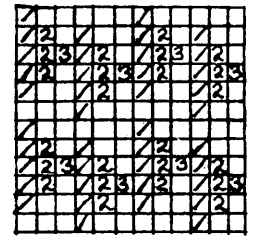

Fig. 145

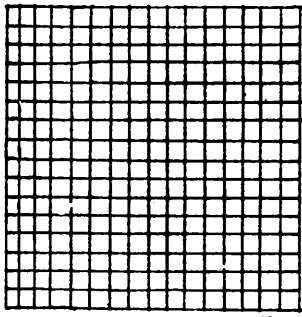
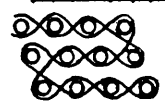

Fig. 146

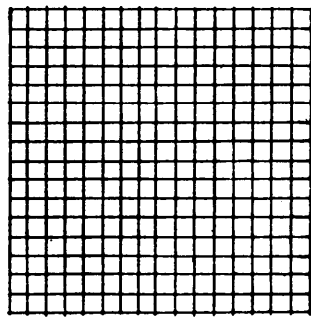

Fig. 147

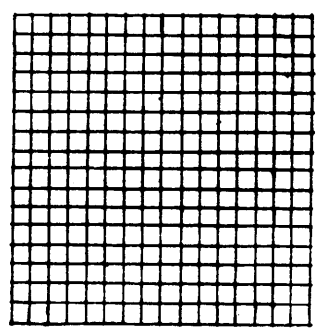
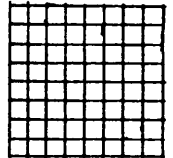
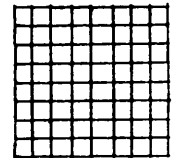

Fig. 148



Face



Face

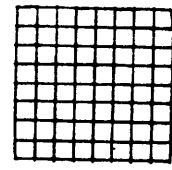

Face

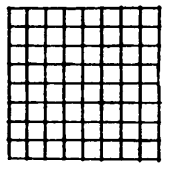

Back

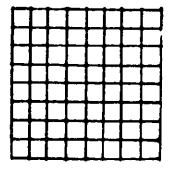

Back

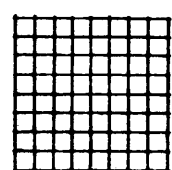

Back

but by allowing the ends to weave in plain order at intervals the result would be a bag. Fig. 144 gives an example of a cloth to open out to double the width. Fig. 145 illustrates the principle of construction of a cloth to open out to three times the width. Sections of the respective cloths are also given. Make designs of your own on the spaces provided and weave them.





Double Plain Cloth patterns are made by arranging the ends of the warp, 1 end one colour and 1 end another colour and using two colours of weft, by a method of designing two plain cloths can be made, and by allowing the two cloths to exchange places figured effects can be developed in double plain weave. Fig. 149 gives an example which may be woven on a 16 shaft dobby, loomed straight draft with a one colour warp and two colours of weft, a two colour warp would be better, but this example will explain all that is required if pegged and woven. Assuming that two colours of warp and weft are used, arrange the pattern on design paper 1 end white  1 end black , 2 picks white , 2 picks black , each cloth on its own ends and picks, then lift all black warp on white picks where white is required to show on the face to suit the pattern, and, lift all white on black picks where white is required to show on the face to suit the pattern.

Fig. 150 gives part of a Jacquard pattern developed in double plain to be cut in the ordinary way and woven with one warp and two wefts (two picks of one colour and two picks of another colour) on an ordinary Jacquard tied up straight tie.

Special Jacquards for Double Plain Cloth are made as shown in Fig 151 the object of which is to save time in designing and also to save cards. Each needle controls two hooks 1. 2. with their snook ends turned in opposite directions, two giffes are used, one for each lot of hooks, the hooks 1 with their snook towards the cylinder work the harness for the black warp, the hooks 2 with their snook ends turned away from the cylinder operates the white warp. The comb board is divided into four longitudinal slips, with the harness knotted above, the 1st and 2nd slips for the black warp and the 3rd and 4th for the white warp, the ends are drawn

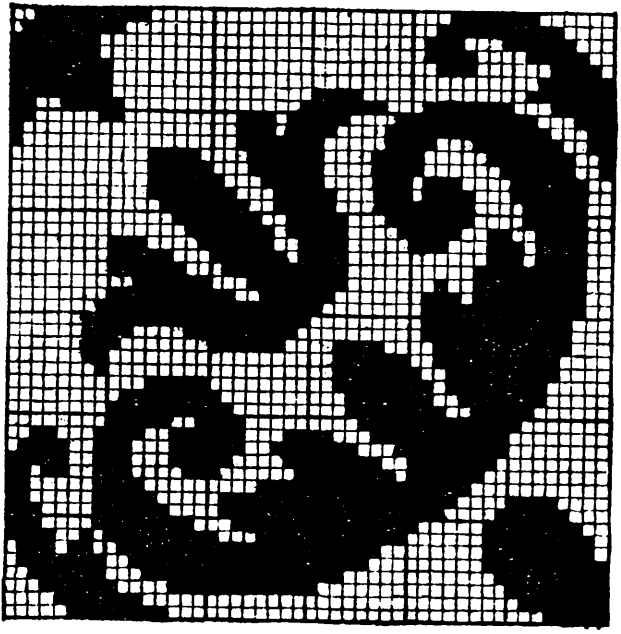
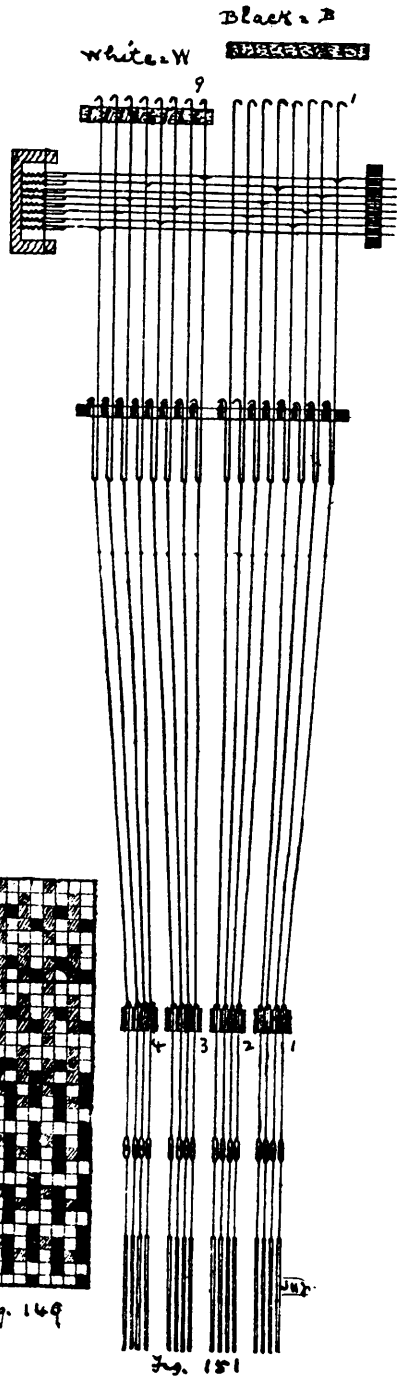

Fig 152

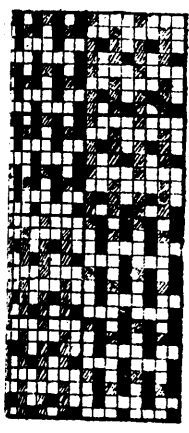

Fig. 149

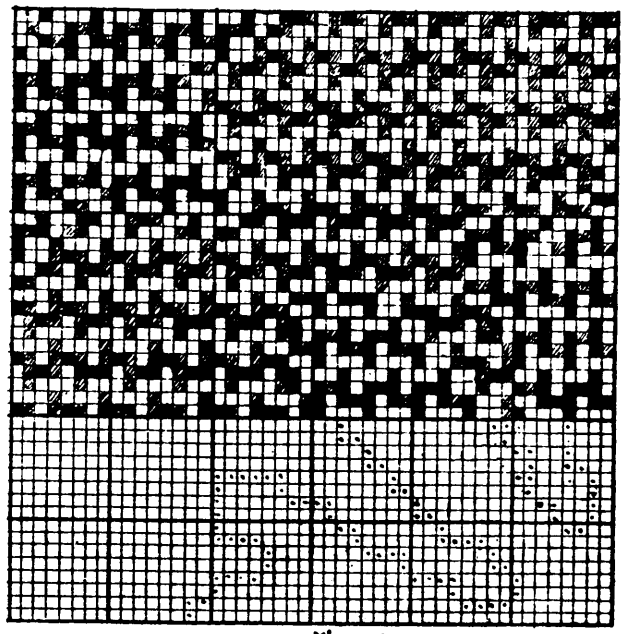
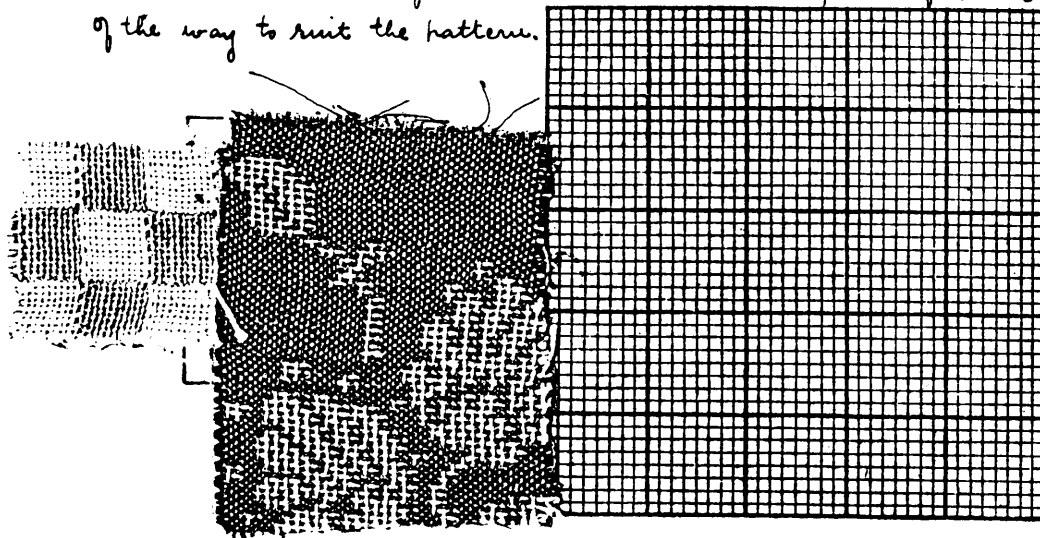

Fig 150

Fig. 151

40 in 1st end black, 2nd white 3rd black and 4th white and so on alternating all the way across the warp. The pattern is painted up solid as shown in Fig. 15² and cut on the cards as painted. Each card serves for two picks, on the 1st pick the holes in the card which have been cut to suit the pattern operate the black hooks which are then taken up by the gripper B and the white comber boards are separated and a white pick goes in (the black warp has been lifted out of the way where black is required to show on the face to suit the pattern; on the 2nd pick with the same card in action the white hooks are operated upon by the blank portions of the card and are taken by the gripper W. the black slips of the comber board are separated and a black pick goes in (the white warp has been lifted out of the way where white is required to show on the face to suit the pattern). The comber boards are worked by tappets fixed at side of the loom, and their function is to make plain cloth. The work of the Jacquard is to lift the warp of the opposite colour to be kept out of the way, namely, when a white pick goes in all the black warp is lifted out of the way to suit the pattern, when a black pick goes in all the white warp is lifted out of the way to suit the pattern.



In making a double plain cloth with two wefts a changing shuttle box loom will be required either a Drop box or a Circular box loom will do the work.

Some modifications will also be required in the working of the Jacquard, as the description just given applies to a loom where 1st a black and then a white pick is put in, and a pick and pick loom would be required, when it is desired to work with an ordinary box loom to change shuttles every two picks the order of working will be

no. 1 card { 1st pick Black gaffe lifting, white comber boards separate and a white pick goes in
 2nd pick white gaffe lifted, black comber boards separate and a black pick goes in.

The card cylinder then turns to

no. 2 card { 3rd pick white gaffe lifted, black comber boards separate and a black pick goes in.
 4th pick black gaffe lifted, white comber boards separate and a white pick goes in.

The sketch below will make the matter clear.

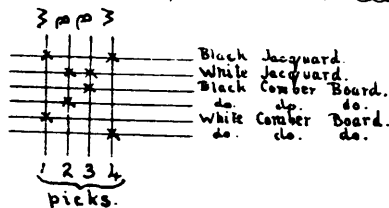

Fig. 153 illustrates the principle of working of a

Circular Box Loom. Fixed to one end of the slay is a circular box 1, consisting of six chambers for six separate shuttles, fixed to the box end is a plate 2 provided with six short pins, two upright catches 3 and 4 are placed one on each side, the ends are fixed to two levers 5 and 6 respectively, both these levers have a common fulcrum 7, at the other ends of these levers are upright catches 8 and 9, one for 3 and one for 4; in close contact with the upper parts of

42

8. 9 is the free end of the lever 10 with fulcrum at 11; at the other end of 10 and fixed to it is a pin 12 which rests on the top card of a series of flat steel cards carried by the cylinder 13. A pawl 14 on the lever engages with the cylinder 13 and rotates it every two picks. On the bottom shaft of the loom is a tappet 15 which lifts the lever 16 once every two picks. The other tappet 14 lifts the upright rod 18 and through the connection shown the lever 11. The change in the lozes is brought about by cards perforated or left blank to suit the pattern, these cards are laced together and are passed each in their turn over the cylinder 13. Assuming that there is a hole in the card over which the pin 12 is resting, the pin will fall through and that end of the lever will be lowered, working on the fulcrum 11 the other end comes into contact with B and pushes it over a knife edge stud fixed to 16, on 16 being lifted by the tappet. B is also lifted, assuming that B is connected to 3 the lozes will be turned to the left, if the pin belonging to the other lever drops through a hole in the card 4 is pulled down and the lozes turn to the right. Catches 14 and 14^a lock the lozes. 18, 19 and 20 prevent breakages in event the lozes get blocked and cannot turn. 21 is connected to the finger and stops the card cylinder when the weft breaks.

Gauze and Leno Weaving.

In this class of weaving the pattern is produced by some of the threads of warp twisting around other threads to accomplish this a special kind of heald is used, termed a Doup heald as shown in Fig. 154 it consists of an ordinary heald B and a loose half of a heald A Fig. 155 illustrates the crossing of the ends in a simple gauze example and Figs. 156 and 157 show the arrangement of healds and method of working to produce the cloth; the letters indicate the same parts in both

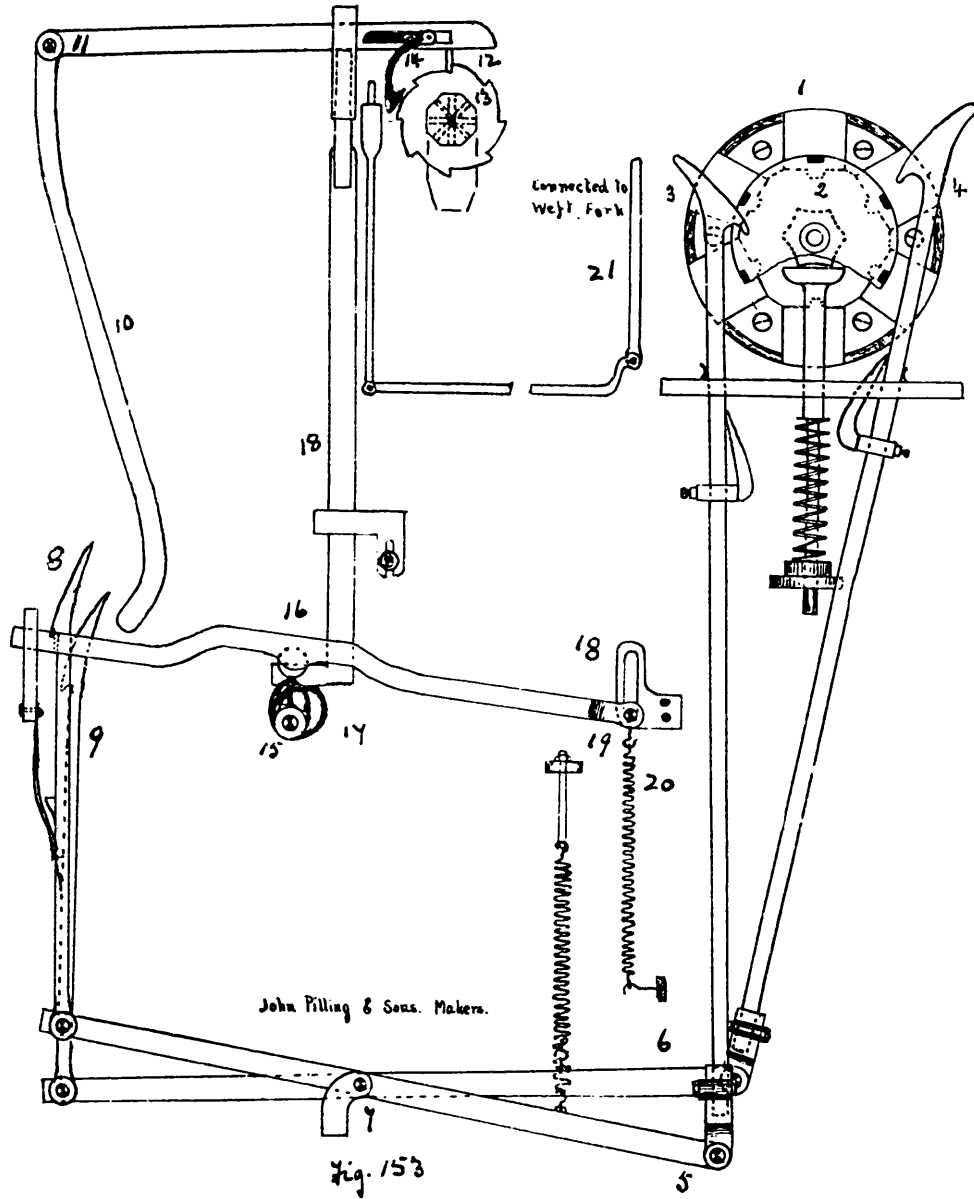

74 sketches. A: loose slip, B: doup, C: standard or the heald through which the doup end is drawn in addition to being drawn through the loose slip of the doup, D is the heald through which the crossed end is drawn, in this example it never lifts, the doup end being lifted first on one side and then the other of the stationary end. In Fig. 156 the standard and loose slip are lifted bringing up the thread on the near side and giving the open shed crossing. In Fig. 157 the standard C remains down, the doup A.B is lifted and takes up the doup thread on the far side of the stationary end and makes the crossed shed. To prevent a breakage of the yarn by a crossing of the ends in the shed, all the doup ends are drawn over a "slackener bar" which is released by one of the jacks of the dobby and allows the doup ends to give way. Fig. 158 illustrates the looming and peg plan, the horizontal lines represent the healds and the X's the healds through which the respective ends are drawn, the numbers 1, 2, 3, 4 on the lines at right angles to the healds indicate the picks, the \circ^s indicate the lifting of the healds on the respective picks. Fig. 160 shows Fig. 159 on design paper with looming and peg plan, this method is a preferable one, as it enables the work to be done more quickly, the X's indicate the lifting of the standard and the \circ^s the lifting of the doup. In filling in the looming and peg plan the following rules will be found useful.

- ① The slackeners are placed behind all the healds.
- ② The loose slip is placed in front immediately followed by the doup.
- ③ In putting down the peg plan, first put down the lifting

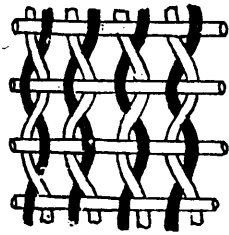

Fig 155

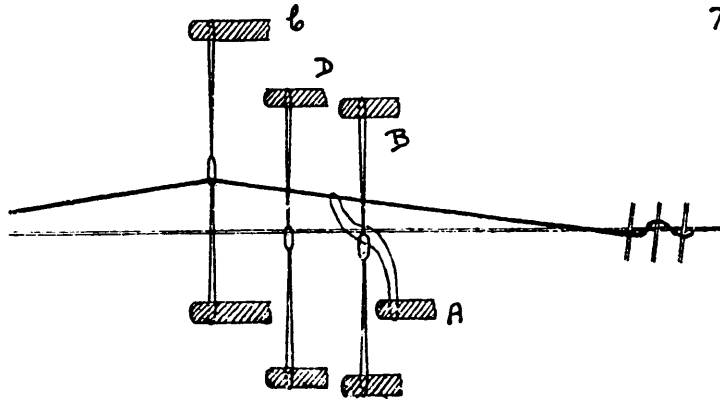

Fig. 156

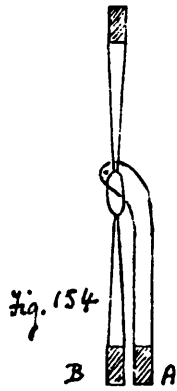

Fig. 154

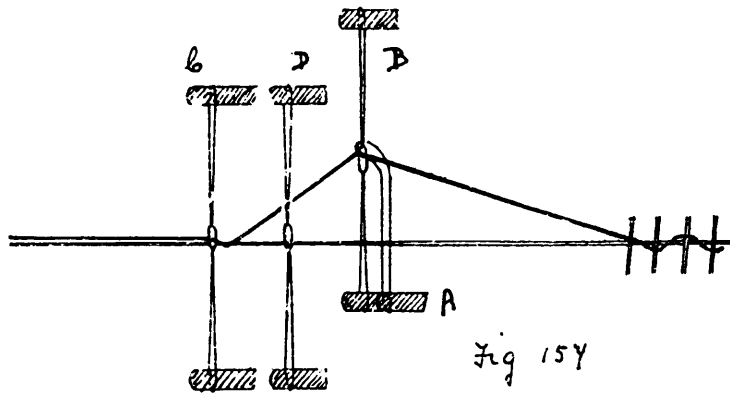

Fig 157

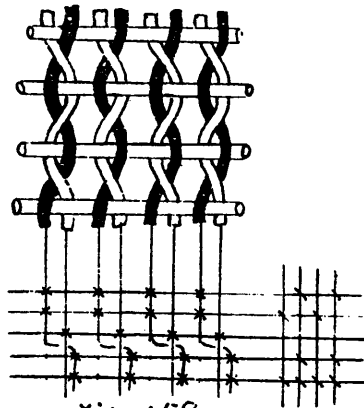
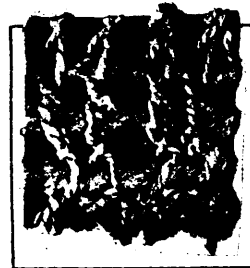

Fig 158

Stacker.
Standard.
Crossed end.
Deep.
Loose slip.



of the ordinary healds omitting the doups, loose slips and slackeners.

④ Put down the lifting for the doup and lift the slackener and the loose slip belonging to it at the same time.

⑤ Put down the lifting of the standard and lift the loose slip belonging to it at the same time.

Fig. 161 gives a plan of the cloth and Fig. 162 show the same on design paper with loomings and peg plan.

Fig. 163 shows one thread crossing three threads and Fig. 164 gives the same on design paper.

Fig 165 gives a plan of a cloth for a two doups pattern and Fig. 166 shows the same on design paper, it

can be seen that the doup end can be crossed over to the right or to the left in the loomings at the wish of the designer and

also that the standard heald may be placed in front or behind the healds carrying the crossed ends, in this example the standards are in the front position.

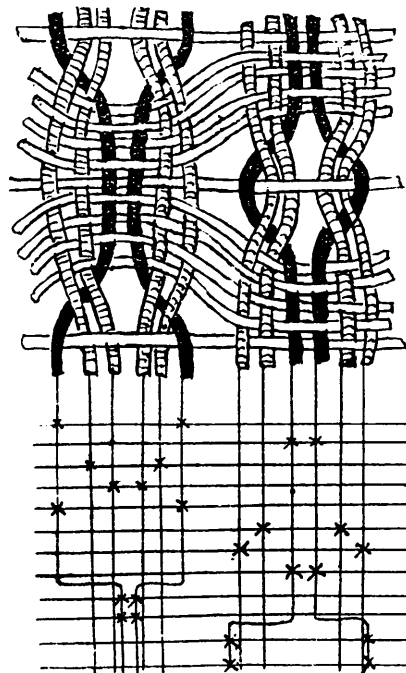

Fig. 165

- Slackner.
- crossed end.
- Standard.
- crossed end.
- Standard.
- Doup
- Loose slip
- Doup
- Loose slip.

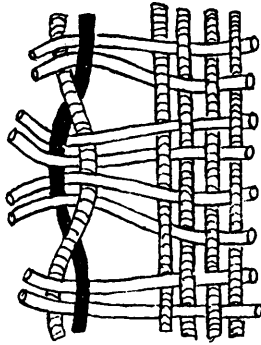

Fig. 159

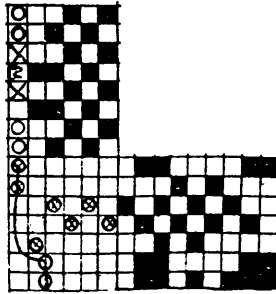

Fig. 160

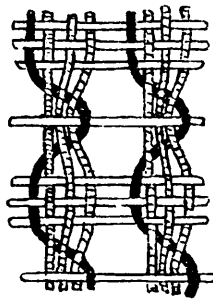
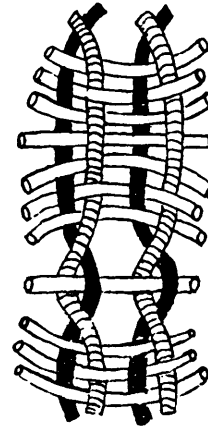

Fig. 163

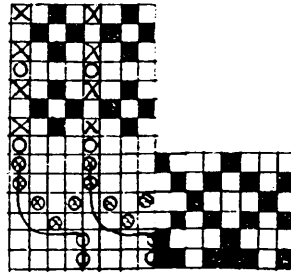

Fig. 164

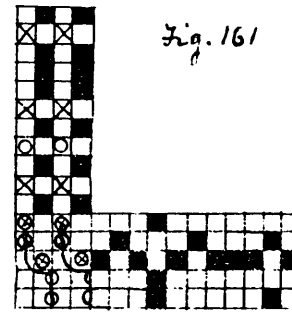

Fig. 161

Fig. 162

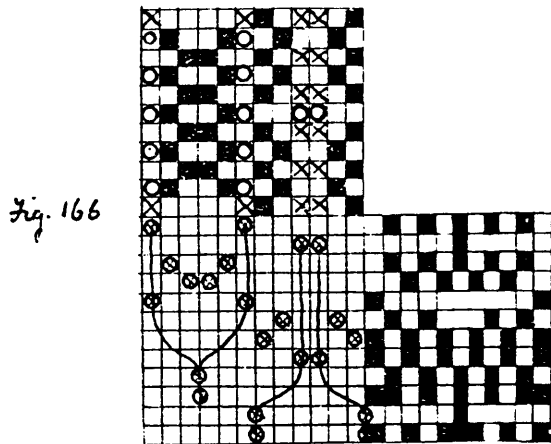

Fig. 166

Slackner.
 crossed end.
 Standard.
 crossed end.
 Standard.
 Deep.
 loose slip.
 Deep.
 loose slip.

28 Fig. 167 gives another example of a plan of a cloth requiring two doups and Fig. 58 gives the same on design paper with the doup ends crossing to the centre in each case. A number of cloths must be selected and examined from the wrong side of the cloth and the pattern put down on design paper, showing loomings and peg plan in each case, for this purpose different colours must be used, namely separate colours for the doups, standard and crossed ends.

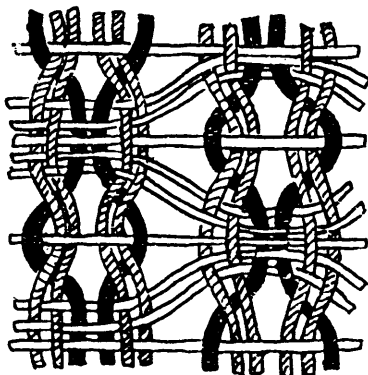

Fig. 167

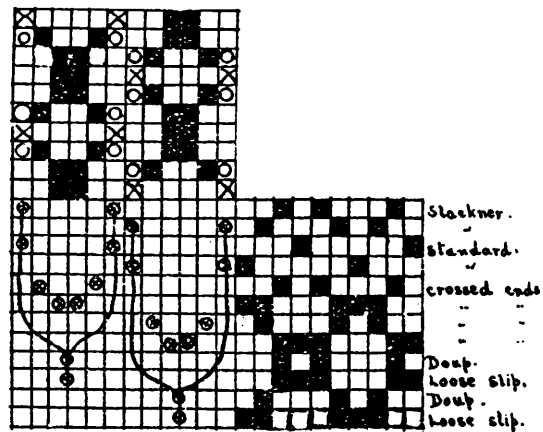
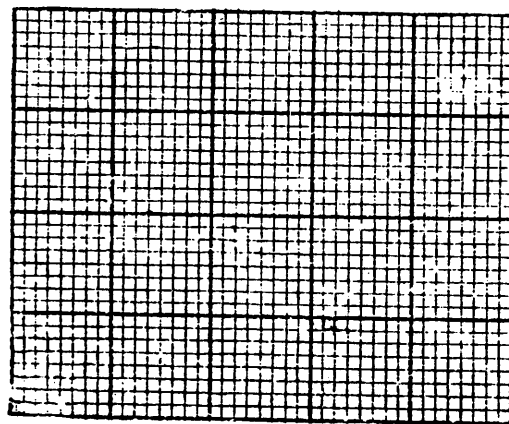
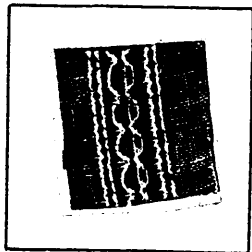
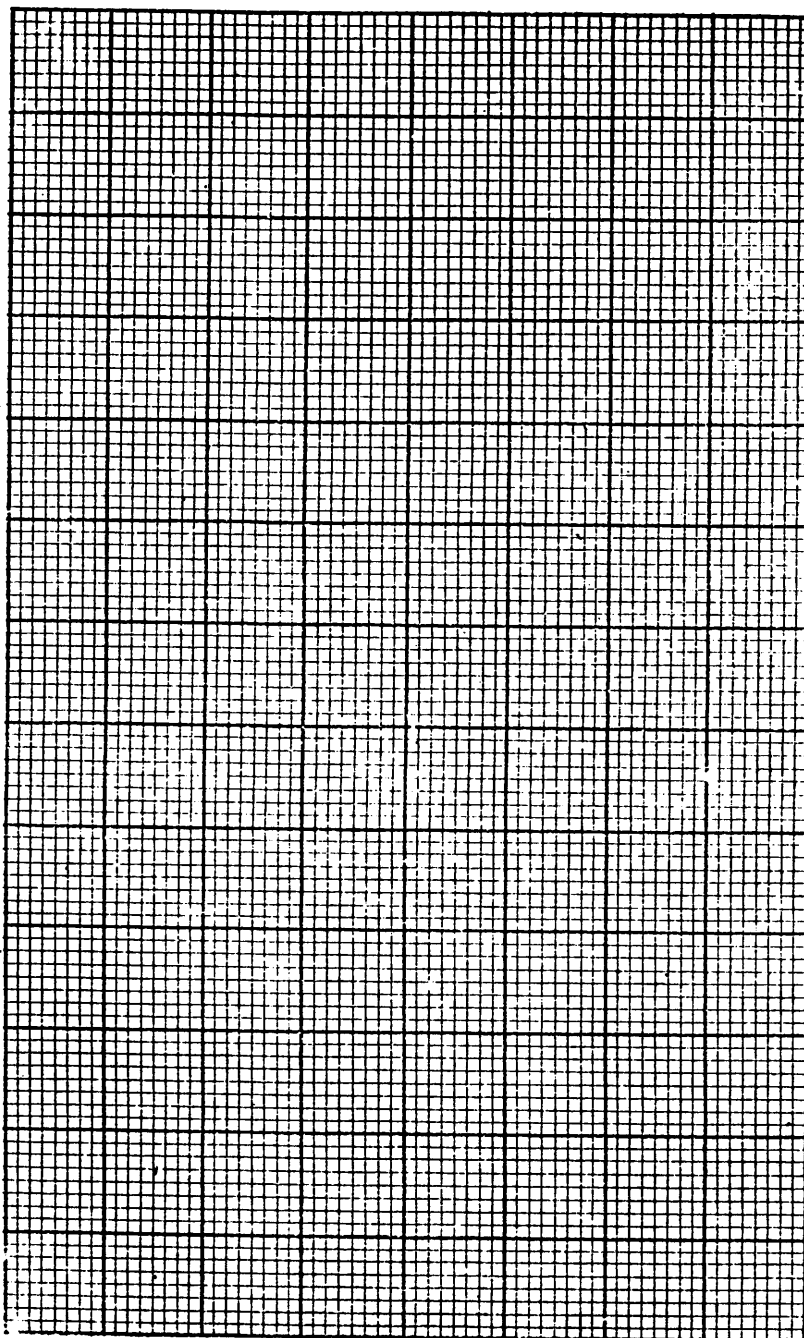
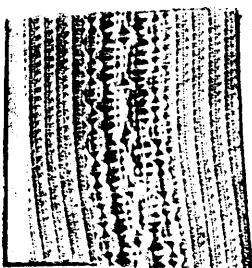
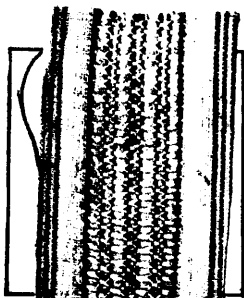
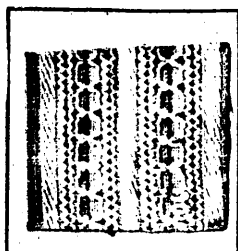

Fig. 168





80 In Fig. 169 is shown the arrangement of a Leno pattern using two doups; a pattern plan of the cloth is shown and above the pattern is the looming, to the left of the looming is the arrangement of the healds and beams and to the right the peg plan for both bottom and top doups. Leaving out the healds and the beams this system affords a quick and ready method of placing patterns on paper, it is also useful in making original designs as the effect produced is more easily followed than is the case when patterns are placed on design paper.

Top Doups In Fig. 169 the difference in the peg plans for bottom and top doups is that in top doups the blanks become filled in squares throughout except the slackeners which remain the same. Weaving with top doups have many advantages over weaving with bottom doups namely.

① The pattern is on the face of the cloth, therefore any imperfections can be more readily seen. ② Top doups are in a more convenient position for repairing. ③ Shakers contrivances can be more readily adopted and become more direct in their action, this is more especially so, in the case of using tappets for Leno Weaving.

Tappets Fig 170 illustrates the arrangement when weaving a Gauze cloth with tappets, Fig. 171 shows the pattern of cloth produced. In Fig. 170 1. is the loose slip connected by a spring to the fixed arm 10. 2. is the doup heald connected to the top roller and also to the slackener lever 5 with its fulcrum at F, the other end 6 is connected by 7 and 8 to the slackener rod 9 over which the doup warp passes, only one beam is required. 3 is the heald for the crossed end and 4 the standard which is lifted on every pick, the tappets 12 and 14 work healds 2, 3 also not the loose slip. Smaller tappets 13, 13 work heald 4, pulling it down a half lift just previous to crossing taking place.

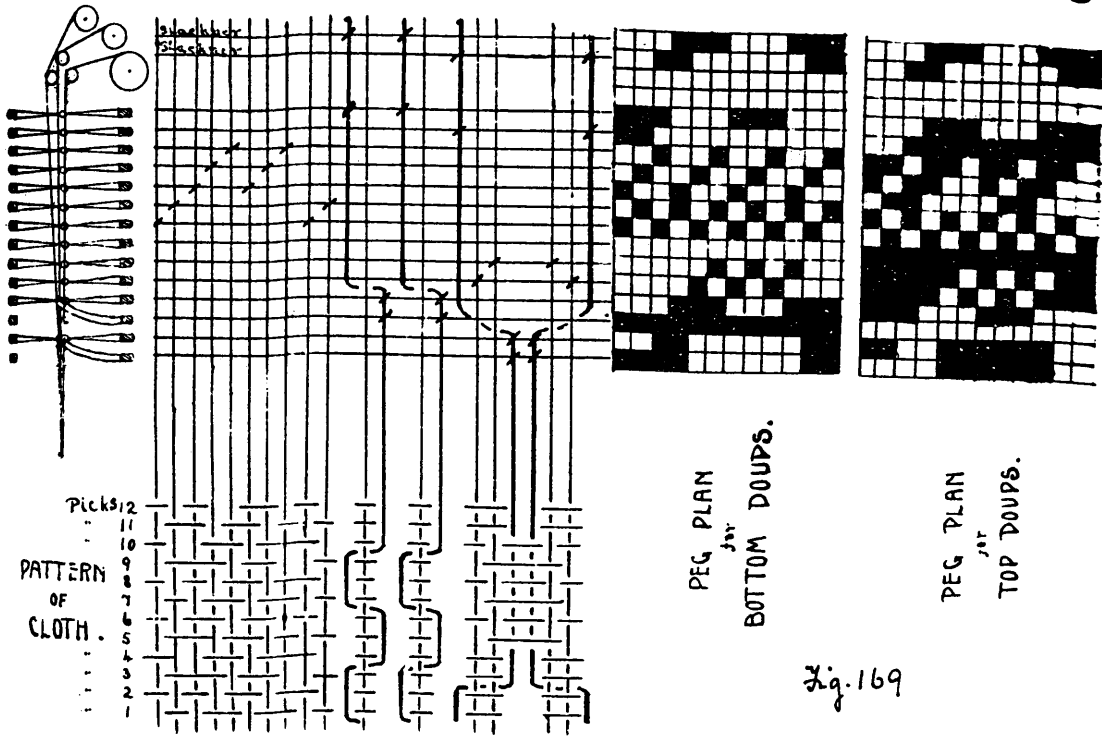

PEG PLAN
FOR
BOTTOM DOUPS.

PEG PLAN
FOR
TOP DOUPS.

Fig. 169

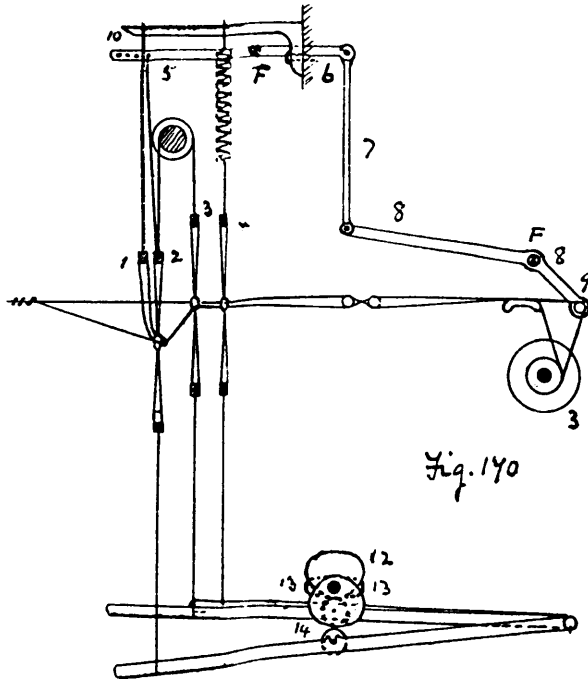

Fig. 170

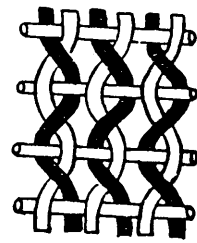
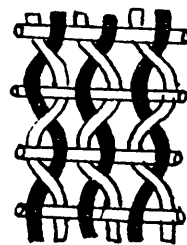

Fig. 171



Shaker Motions are used when a half lift is required to be given to a crossed end to enable a doup end to cross underneath. A consideration of the action taking place in the weaving of a hure gauge cloth will make the matter clear: in Fig. 172 the crossed end is lifted on every pick, the crossed end B is never lifted; on the 1st pick A is lifted by the standard, on the 2nd pick by the doup and as the end B never lifts, it will be difficult for the end A to pass underneath it, that is, if the cloth is to be woven with a double lift dobby, an arrangement has been introduced by Lupton & Place Pat. no. 4, 1908 and applied to double lift dobbies to overcome the difficulty Fig. 173 it consists of a crank fixed to the end of the crank shaft which works a rod 1 which is connected to a lever 2 fixed on the top of the dobby, the oscillation of lever 2 revolves a roller 3 a spring 4 acting in the contrary direction to the lever, to this roller the jacks of the dobby shown in 5 and 6 are attached and give to the healds a half lift. Another arrangement is to connect the crank arm by means of a short rod 1 Fig. 174 to a lever 2 fixed on the top of the loom, all healds required to give a half lift are attached to this rod. In a single lift centre shed dobby is used as shown in Fig. 175 shaker motions are not required as all the healds come to a centre shed on each pick, the fulcrums of levers are shown by the letter F, the rod 1 is worked from an eccentric fixed on the end of the crank shaft, the bottom board 2 falls as the gripper 3 rises and every pick all the hooks are brought level.

Fig. 176 shows a tappet constructed for a side tappet loom to give a full for one pick and a half lift for two picks when such an arrangement is required in lens weaving.

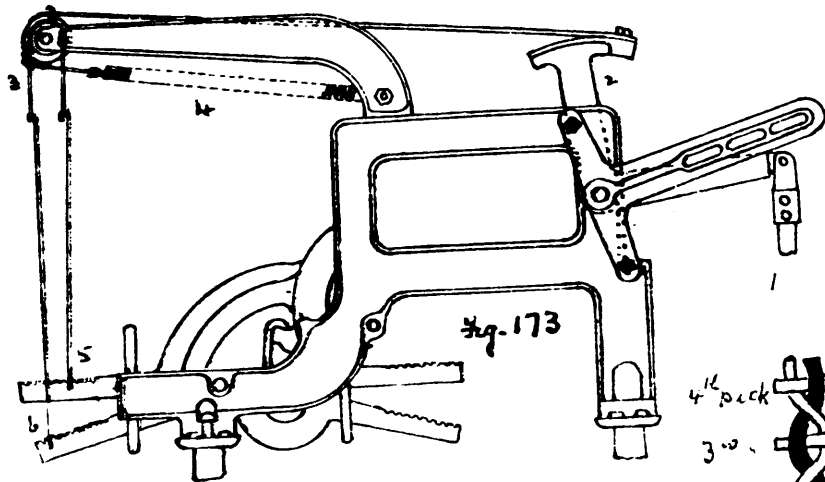

Fig. 173

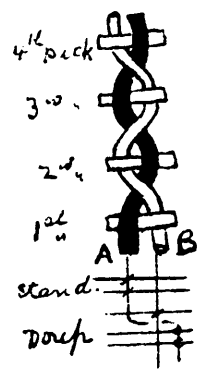

Fig. 172

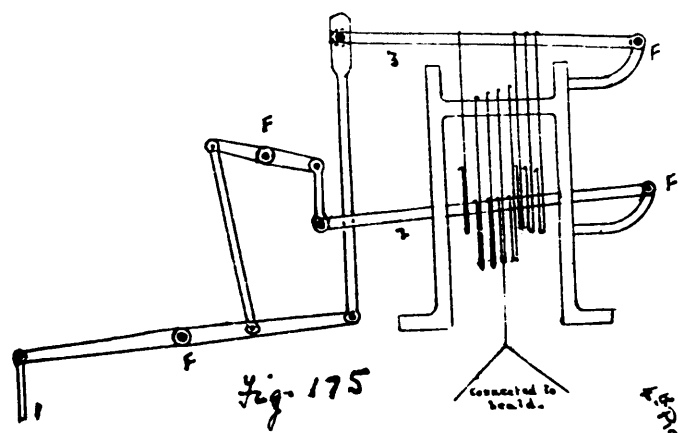

Fig. 175

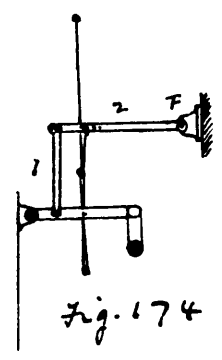

Fig. 174

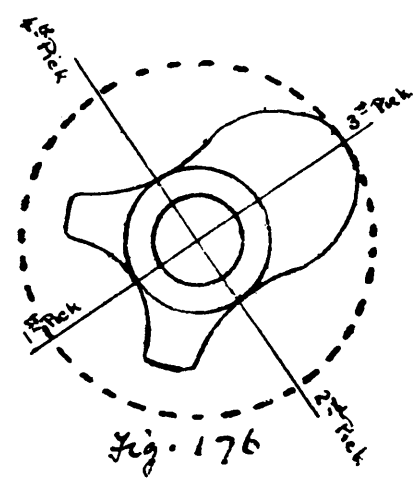

Fig. 176

Leno Jacquards are machines used for weaving Gauge patterns which are out of the range of a Dobby, the whole of the harness is douped throughout, generally two ends crossing two, by this means an almost endless variety of patterns can be woven of gauge and figure weaving combined. Fig. 177 A complete douped harness required a large number of slackeners, in a 200 machine with two ends crossing two, 50 slackeners will be required, instead of having bars for the purpose as in Dobby lenos, the harness is used for the purpose, in the sketch there are 12 rows of hooks and 10 rows of needles, the middle 8 hooks work the ordinary harness and the two outside rows on each side of the 8 work the slackeners and the doup harness, the needle controlling a doup hook controls the corresponding slackener hook, two separate lifting giffes are used, the giffe for the slackener receives only half the lift of the ordinary giffe. All the loose slips from the Doup harness are fixed to a heald stave, and this is connected to the lifting giffe by means of a cord and as the machines are always single lift, the loose slip is lifted on every pick. Fig. 180 which is a design for a block leno check shows very clearly how the ends are drawn in.

In designing for these cloths bold designs must be the rule with not much details, the figures must be surrounded with plain weave before commencing to weave gauge, also it is best to have a wett figure; the figures may be developed in gauge weave if required and surrounded with plain weave.

Fig. 178 and Fig. 179 gives suitable examples for Jacquard leno weaving.

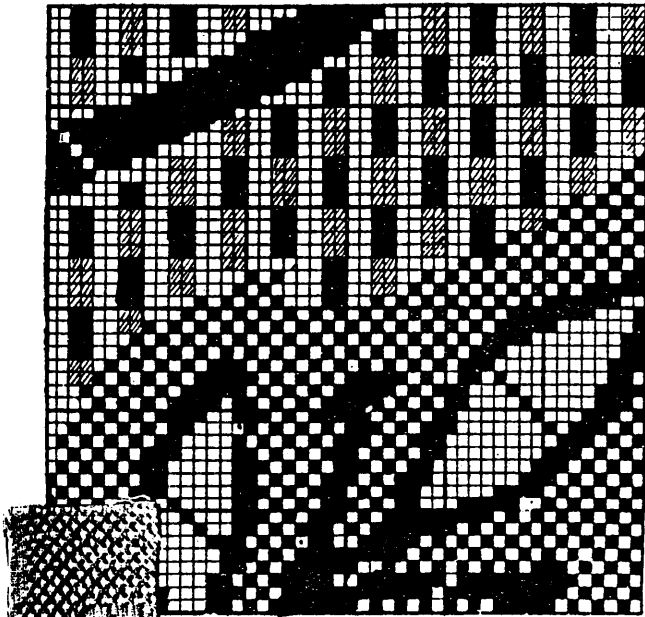

Fig. 178

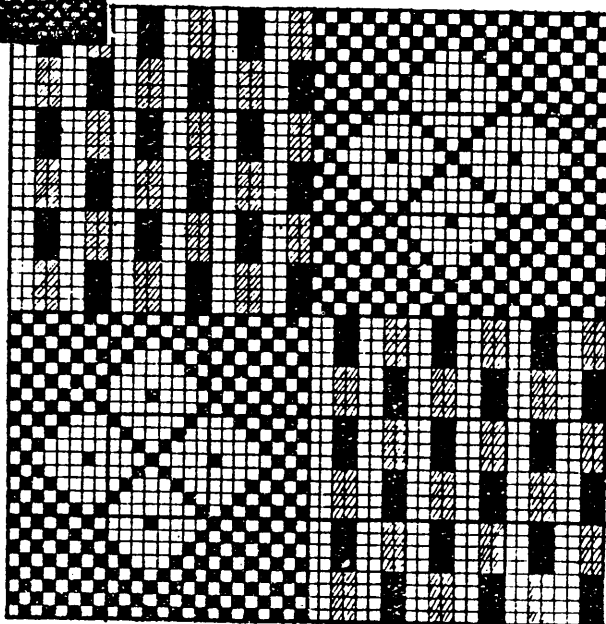

Fig. 179.

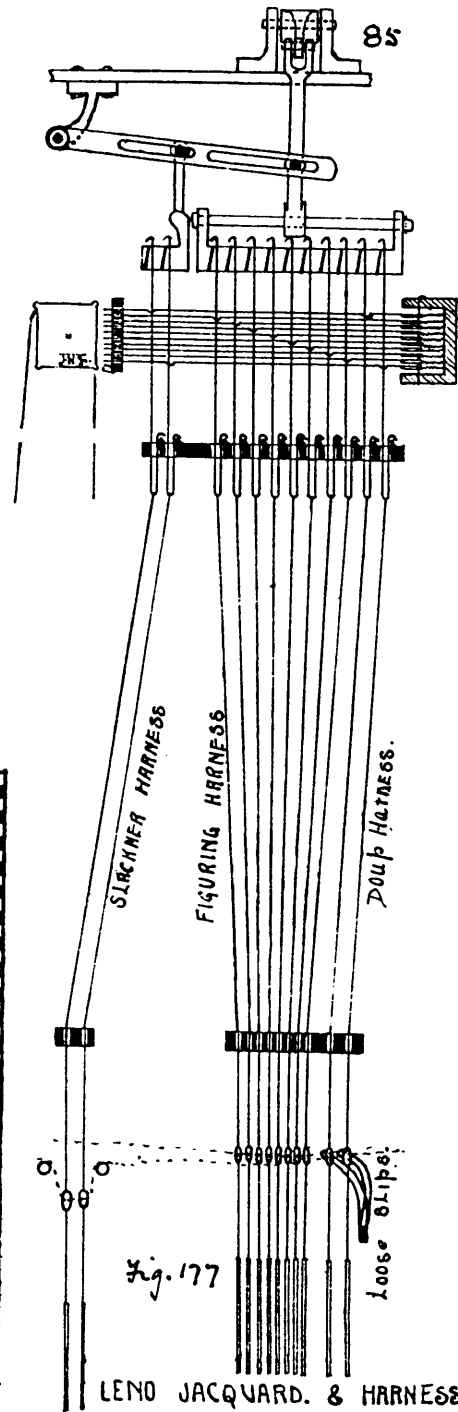
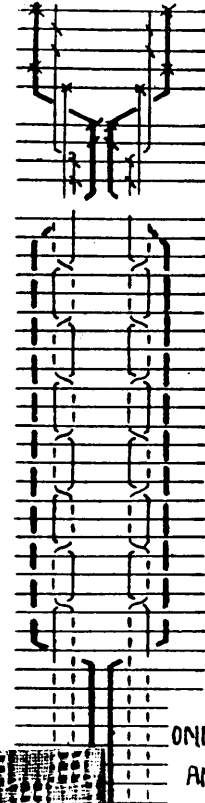
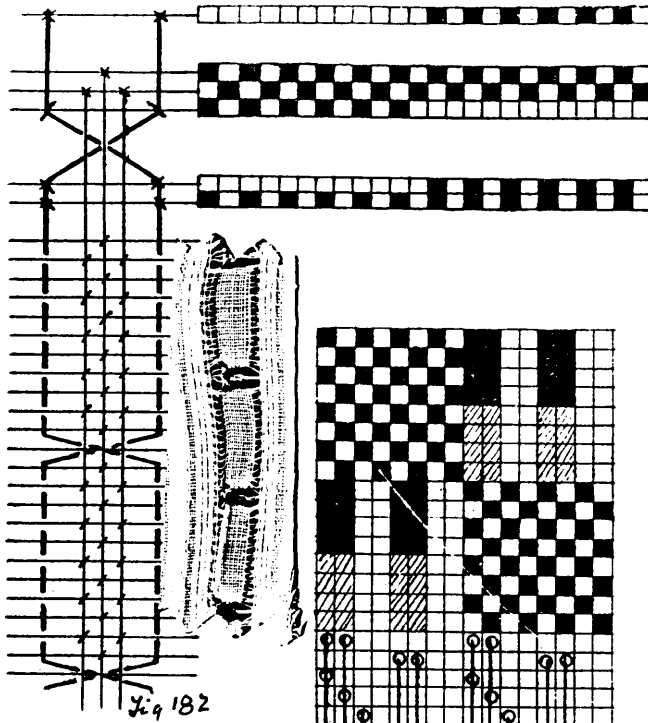
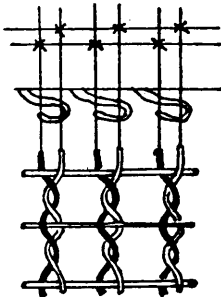

Fig. 177

LENO JACQUARD. & HARNESS.



COMPLETE CROSS OVER.



CAT GUT CROSS .

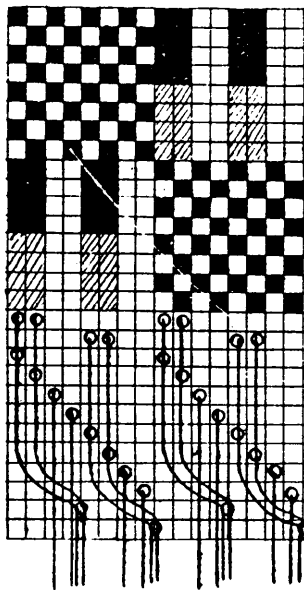

BLOCK LENO CHECK

Fig. 180

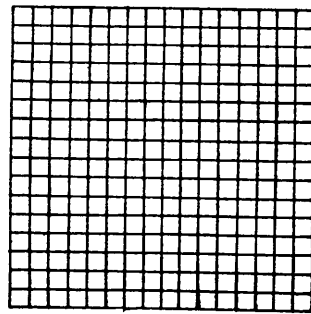

GIVE DESIGN FOR FIG 183.

ONE DOUP. CROSSING ANOTHER DOUP.

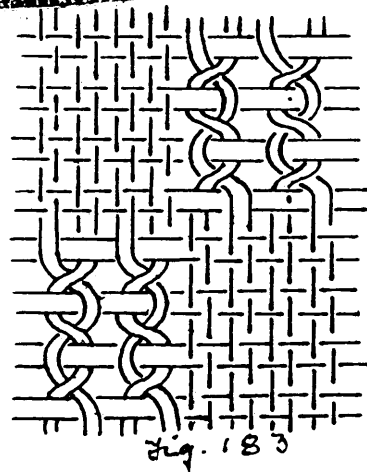
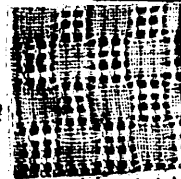

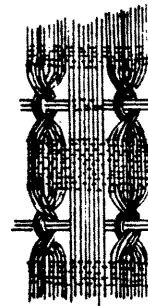
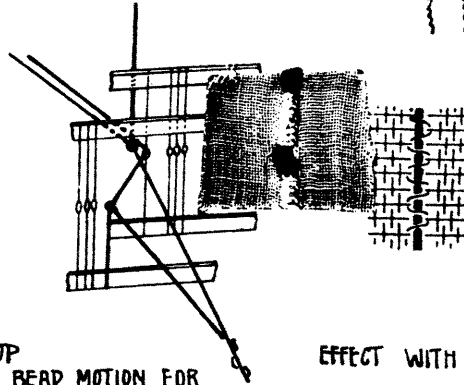
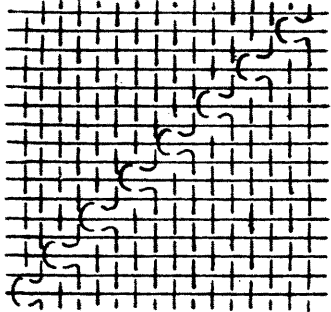
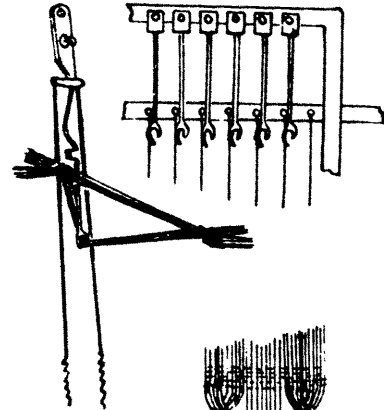
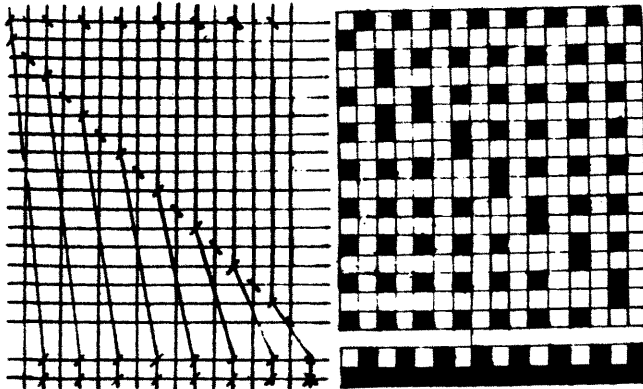

HINGES. PAT. 15844 - 1907
 - - 14279 - 1908

ENLARGED PATTERN WITH ONE DOUP
 BEAD MOTION FOR
 CENTRE SELVEGES.

EFFECT WITH BEAD MOTION.

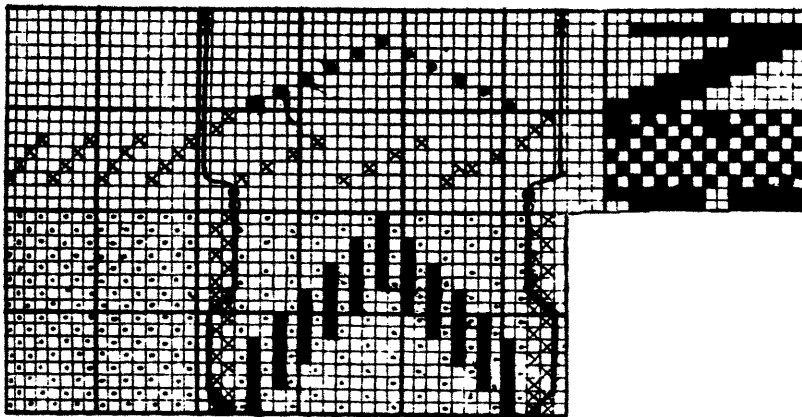

Slackner.
 Standard.
 Extra Warp.
 Crossed Ends.
 Plain.
 Deep.
 Loose Slip.



DESIGN, LOOMING & PEG PLAN FOR LENO WITH EXTRA WARP EFFECT. TOP DOUPS.

Madras Muslins are a type of cloth with extra weft effects in coarse material developed on a gauze ground. On examination of a piece of Madras muslin cloth, it will be seen that the gauze cloth is being woven on alternate picks with fine weft and on other alternate picks the figure is woven with coarse weft; so that if gauze is woven on the first pick and fine weft inserted and the Jacquard lifts the warp for the second pick according to the order of the figure required and coarse weft inserted the result will be as per sample of cloth. A gauze reed Figs 181 and 182 is used for weaving the gauze, it consists of a reed provided with half dents and ordinary dents, the reed is fixed between the ordinary reed and the front of the harness, it is lifted every second pick and takes up the doup ends, by shifting the harness horizontally too and fro, the doup ends are lifted to the right and left of the ends drawn through the harness of the Jacquard and produces gauze weave. The cloths are woven with the face figure on the underside and the loose floating weft is afterwards cut away.

In some arrangements, instead of the harness having a horizontal movement, the reed moves too and fro Figs 183 and 184 illustrate the mechanism required. Fig 183 shows a side view of the mechanism required to weave the gauze ground, also the two shuttle box motion which is employed, an eccentric 1 driven at half the speed of the crank shaft rocks an arm 2 which communicates its motion to a revolving arm 3 the forked end of which moves the arm 4 turning the tappet 5 and thus depressing 6 which is secured to lever 7, this action lifts the gauze reed 8 on alternate picks as will be seen from Fig 184 each time lever 7 is worked, a

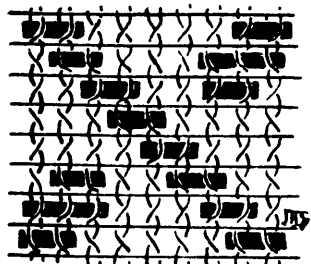

Plan of MADRAS MUSLIN.

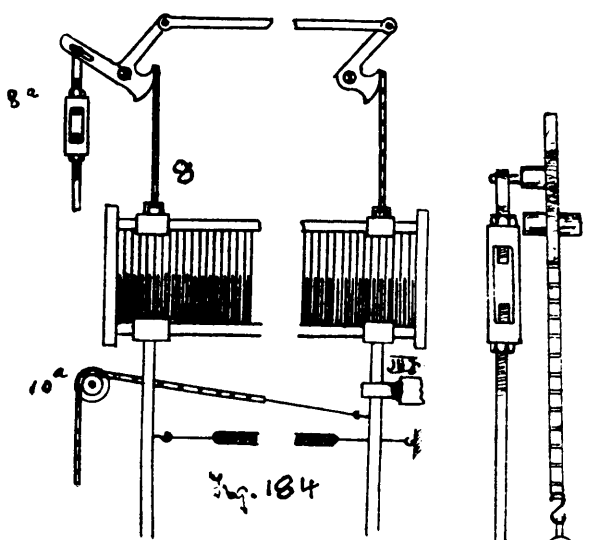
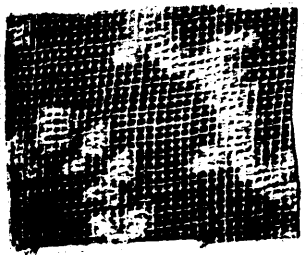

Fig. 184

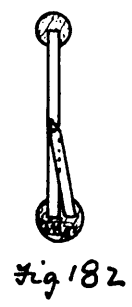

Fig. 182

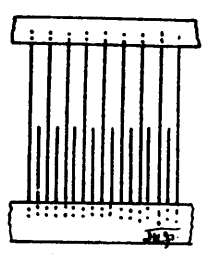

Fig. 181

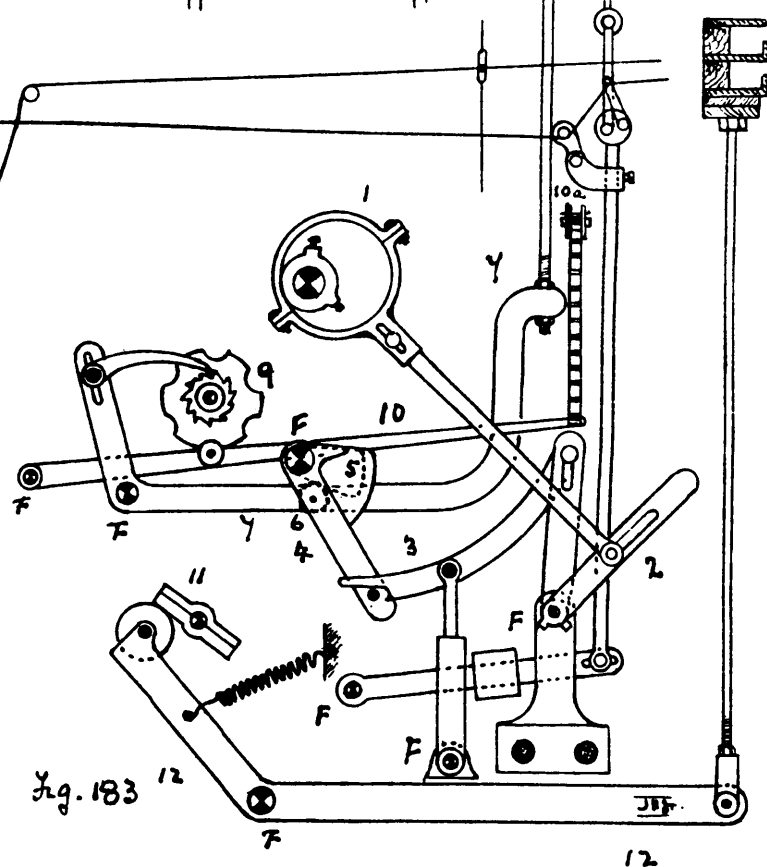

Fig. 183

12

star wheel 9 is turned and the projections and hollows work the lever 10, thus giving the gauge reed 8 the necessary too and fro motion on the gauge picks as shown in Fig 184. The box motion is worked by the tappet 11 and lever 12. The letter F equals fulcrums throughout.

Pick and Pick Looms. These looms are made with a number of boxes on each side of the loom, and a shuttle can be changed for single picks as required, in Madras muslins. There are many arrangements for doing the work. Fig. 185 gives an Overpick arrangement, the principle of which is, that by using picking tappets with a double nose bit and allowing the picking bowl to be fast or loose on the upright shaft any order of picking may be obtained, the whole arrangement is worked from an eccentric wheel and card motion, the movement of the rods and levers in the direction of arrows shown will explain the working.

Fig. 186 illustrates an Underpick pick and pick, an iron shoe 4 and 4^a is made to slide on and off the wood lever at the side of the loom, the movement is under the control of a chain made up of two sizes of links, and is worked through a star wheel 5 and a peg wheel 6 from the bottom shaft of the loom, in the sketch a large link is in action and picking is taking place from the left hand side of the loom, when a smaller link comes under lever 1, 2 is hest into action and 3 out of action. F equal fulcrums of levers.

Fig. 187 gives another Underpick pick and pick, it is worked on the principle of the Knowles motion and is applied to their type of loom where the shedding, boxes and picking are controlled from the same source. In the sketch it will be seen that as the wheel 1 is turned to the left or right the picking tappets are pushed in and out of action.

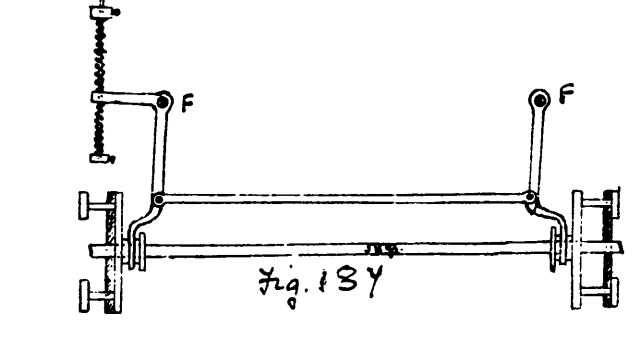
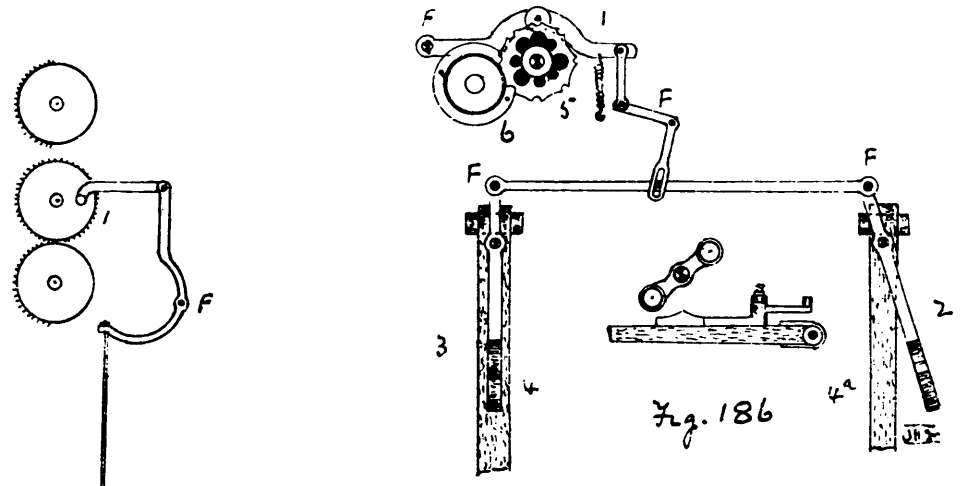
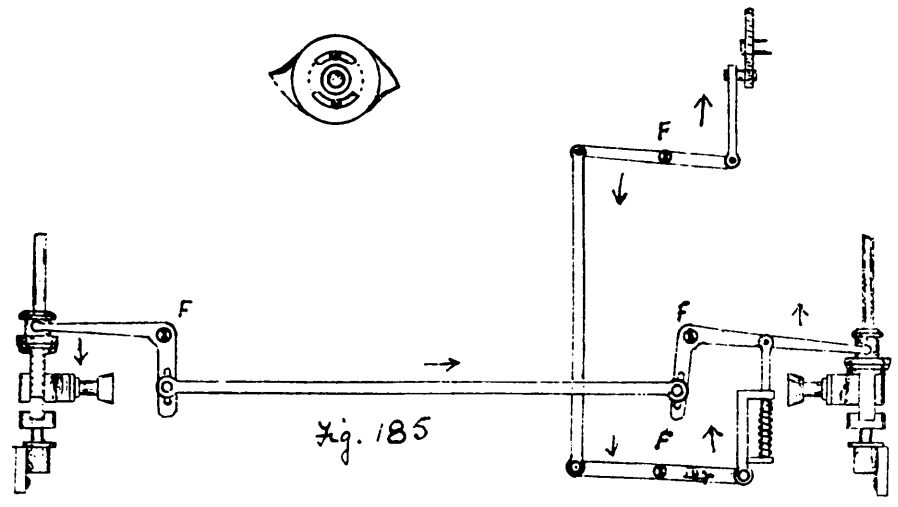

Patent Satin Quilting, the leading feature of this type of cloth is a figure in coarse weft developed on a ground of solid colour. The Jacquard used for the purpose is an ordinary single lift machine with the comber board divided into two parts and the harness knotted above the comber board with the addition of two healds in front of the harness. Two warps are used one heavily the other lightly weighted, the harness is tied up as shown in Fig. 188 the looming is two ends through harness and one end through healds with 3 ends in a dent Fig. 189 and the lifting is
 no. 1 Pick. heald 1 on comb. board 2. no. 2 Pick. heald 2 on C.B. 1.
 no. 3 Pick heald 2 on Jacquard. no. 4 Pick heald 1 on Jacquard.
 with 4 Picks to one card i.e. on the fine picks the ground warp weaves plain with the comber board and the binding warp weaves plain with the healds and on the figuring picks the Jacquard lifts the ground warp for figuring purposes and the healds weave plain cloth to bind the floating weft.

The Jacquard shown contains 12 needles in a row and is a 600 machine, but as there are two harness leashes tied to each hook its capacity is increased to 1200 ends in one repeat of the pattern. The pattern to be woven is painted up in solid colour and is so cut on the cards, the weave and structure of the cloth being brought about by the combined lifting of the healds, comber board and Jacquard combined as previously indicated. The Jacquard is worked by a machine lift to allow the gippe to remain up for two picks and positive tappets of the Woodcroft type are fixed at the side of the loom to work the healds and comber boards. Fig. 190 shows a sketch design with a portion of it painted up on design paper Fig. 192 and Fig. 191 shows a portion of the figure showing the structure of the cloth, examined from the figure side of the cloth.

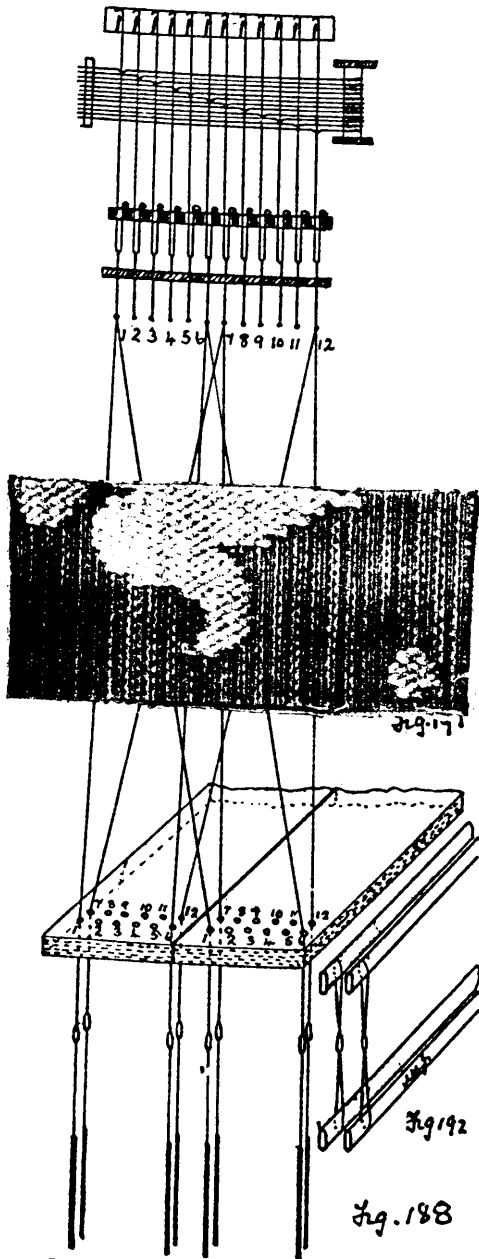

ARRANGEMENT OF HEALDS, HARNESS & JACQUARD FOR PATENT SATIN.

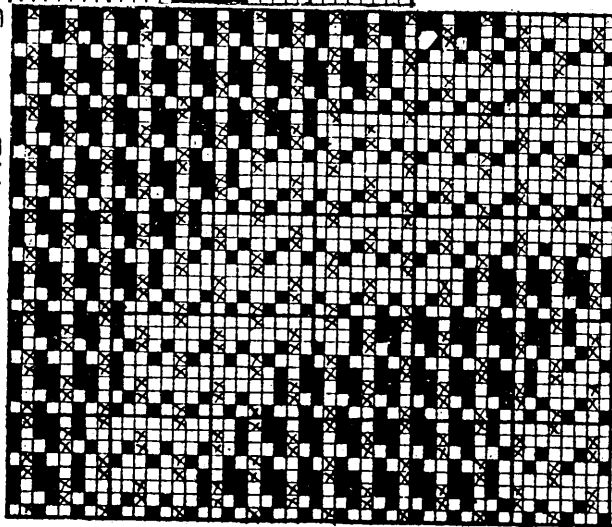
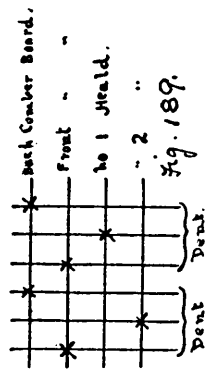
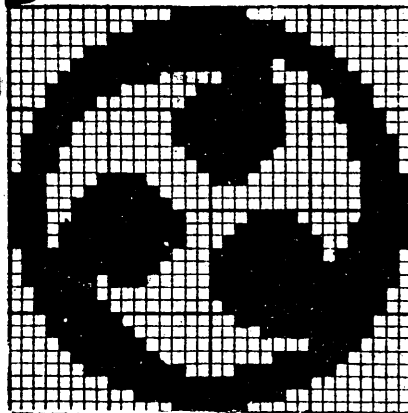
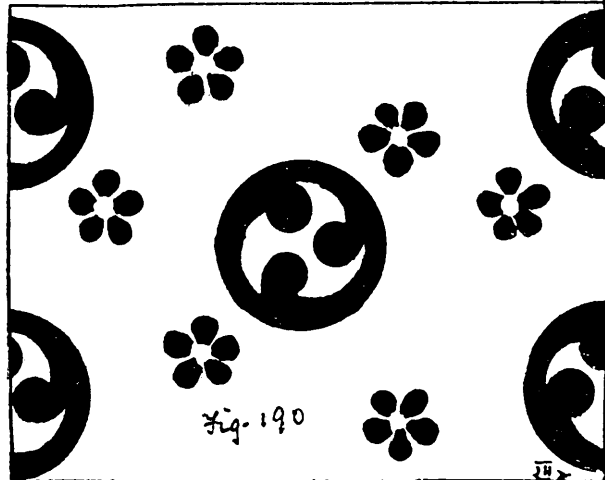

94 Figured Repps. Plain repps are made by using two warps one heavy and the other lightly weighted and two different counts of weft and warp; or by using a fine warp and reed or a coarse weft with a few picks per inch. In a plain figured repp, the same statement holds good except that a warp figure is developed on a repp ground, the figuring warp may be coarser than the ground warp or two ends may be weaving as one. There are several methods employed in weaving these cloths, one of which is to have healds placed in front of the harness, the figure is made by floating the coarse warp on the surface of the cloth, the ends are drawn in one end fine through healds one end coarse through harness, the pattern is painted up solid on design paper with not too long floats, and the card cutting is:-
1st pick, a card cut for the figure (figuring card) to lift the coarse warp in the order of the figure desired and a shed is also made by the healds (worked by tappets for the fine warp, and a fine pick inserted).
2nd pick, the healds remain down, and a card cut solid is presented to the needles of the Jacquard with the result that all the coarse warp is lifted and a coarse pick is inserted (this makes the thick rib across the piece). The cards are laced together one figuring card, one card cut solid. A saving of one half of the cards is effected by allowing the card cylinder to be presented to the needles of the Jacquard only every two picks, the lifting of the whole of the harness on the intermediate pick for the coarse weft being done without a card, or, by using a double lift two cylinder Jacquard, one cylinder may carry the figuring cards and the other cylinder carry four cards cut solid for the coarse weft picks, a saving of one half of the cards is effected. In more elaborate kinds of repps, where various materials are used as wool, worsted, silk and cotton different combined working of the healds and harness may be employed, as the healds lifted and the harness left down with the weft inserted between the two warps, the healds and harness working in combination on both fine and coarse picks.

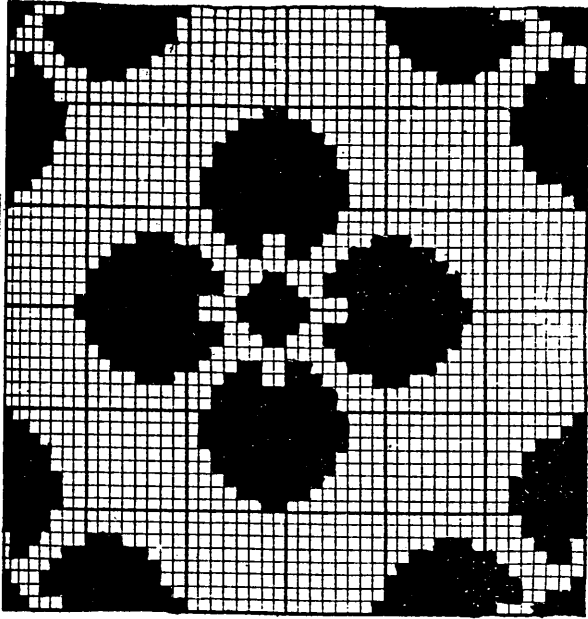

Fig. 194.

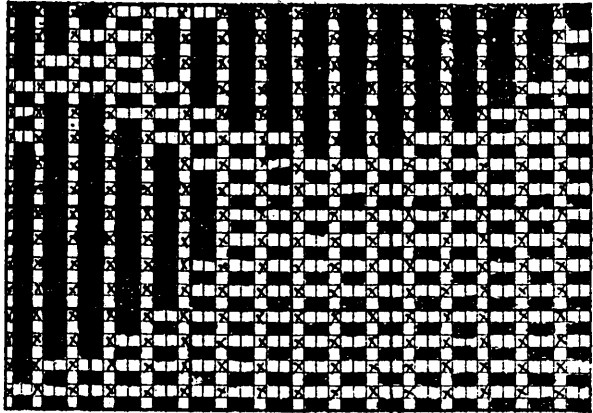

Fig. 195.
 A Small Portion of Fig 194
 as it appears in the Cloth,
 with Two Ends weaving as
 one in the Figure.

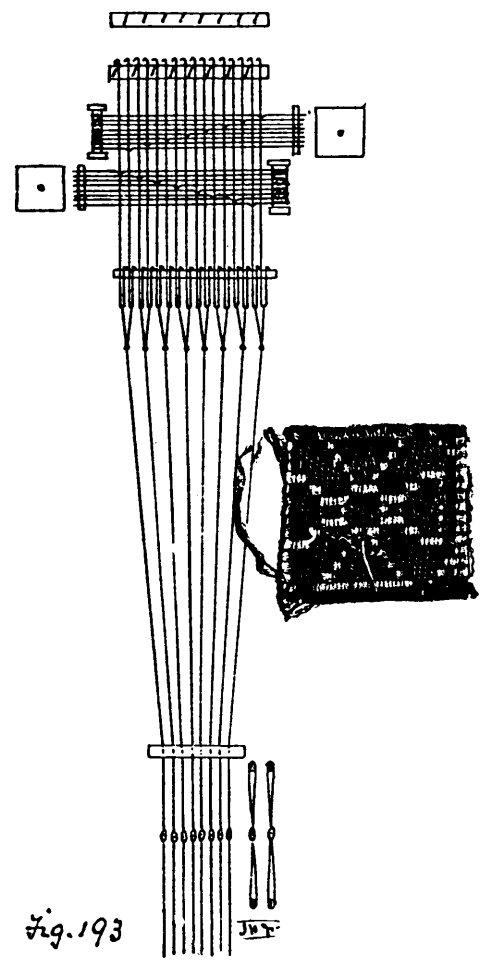
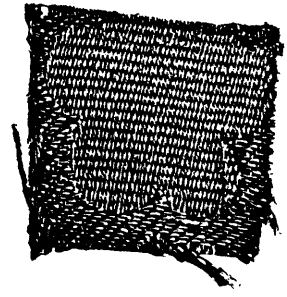

Fig. 193

Jacquard for Figured Repps.



96

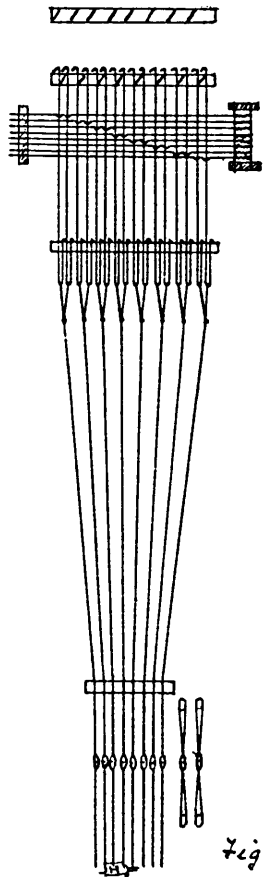

Fig. 196

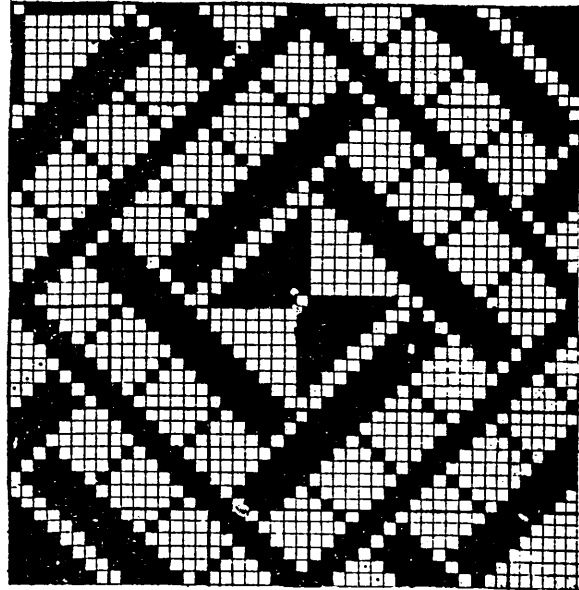
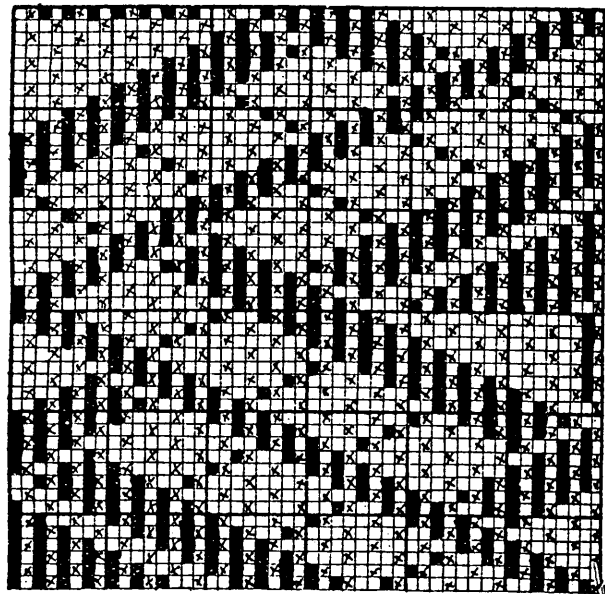

Fig. 194

Jacquard for Alhambra Quilting.



Fig. 198



Alhambra Quiltings are a simple cloth with two warps, ground warp plain coarse reed and thick weft, the Jacq. weaves the extra warp. Fig. 194 gives a design & Fig. 198 Shows Structure.

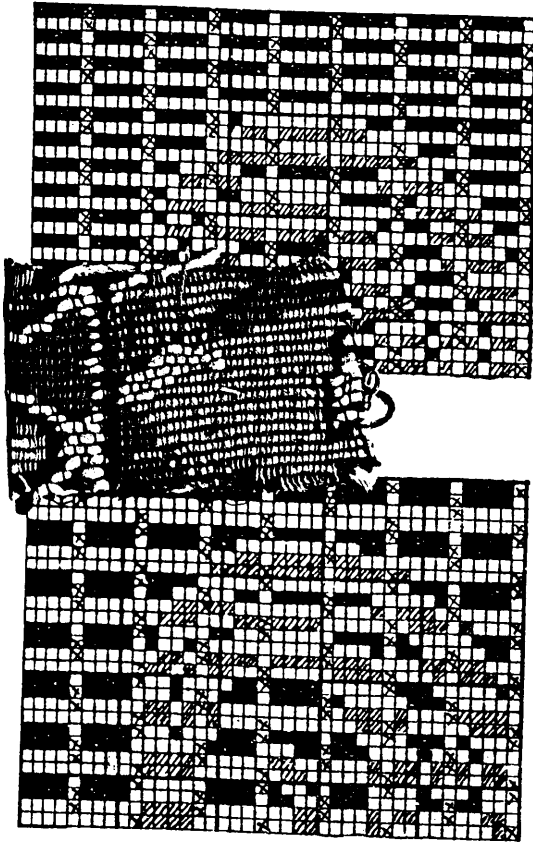

Fig. 200

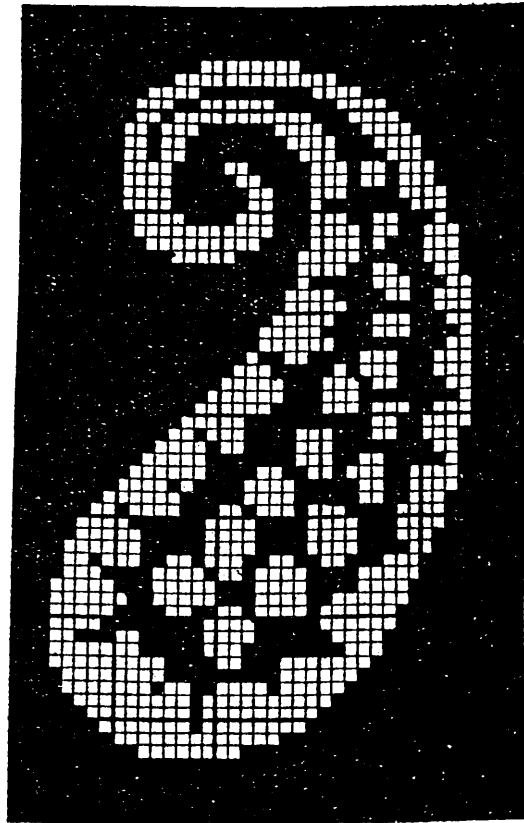

Fig. 198

Weft Tapestries In a two loom Tapestry the pattern is painted up in two colours solid as shown in Fig. 198 assuming the two wefts to be black and white, each pick on design paper will equal two picks in the cloth, therefore each pick is cut twice thus. Fig 199

Card 1a, Black pick, cut all white

Card 1b, white pick, cut all black.

One half the cards may be saved by using a Jace as shown in Fig 201 each card then serves for two picks. A binder warp worked by healds prevents long floats of weft, shown as x^3 in Fig 199 or 200. Fig 200 is arranged 2 and 2 picks.

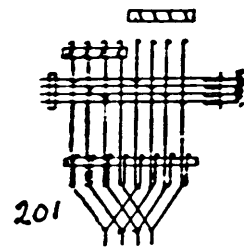

201

98 Two Warps and one Weft Tapestry. Fig. 202 illustrates the type of Jacquard to use, the harness is tied up in two sections, each section working its own colour of warp. the comb board is divided into two parts longitudinally, the harness from the 1st 200 hooks passes through the front part of the comb board and the harness from hooks 201 to 400 passes through the back part of the comb board. Assuming that the two warps are red and green respectively, with one colour of weft, the warp will be dressed on the weavers beam one thread green, one thread red, and will be drawn through the harness, one green, one red, each colour being kept to its own part of the machine. The pattern is painted on design paper in two colours Fig. 203 in the order these colours are required to show in the design and the blanks will serve for white weft. The card cutters instructions will be; Each colour is cut on its own part of the card, assuming that hooks 1 to 200 operate the green warp, these colours are selected from the design and cut on the front part of the card, and by the time half way of the card is reached, half way of the 400 card is reached the 200th end of the design will be reached, therefore, commence again along the same pick and cut the red filled in squares on the second part of the card, and as the weft is to show in the design as well as the warps, the blanks on the design are left blank on the cards. When this card is brought to the needles, it selects the hooks required to lift the respective coloured warps in their proper places to suit the design.

If no binder warp is used it will be necessary to bind the long floats of warp and weft, for that purpose the two coloured warps are brought up into the ground to bind the floats of weft, and on the red figure the red is left down for binding the face and the green lifted for binding the back, on the green figure,

Fig. 203

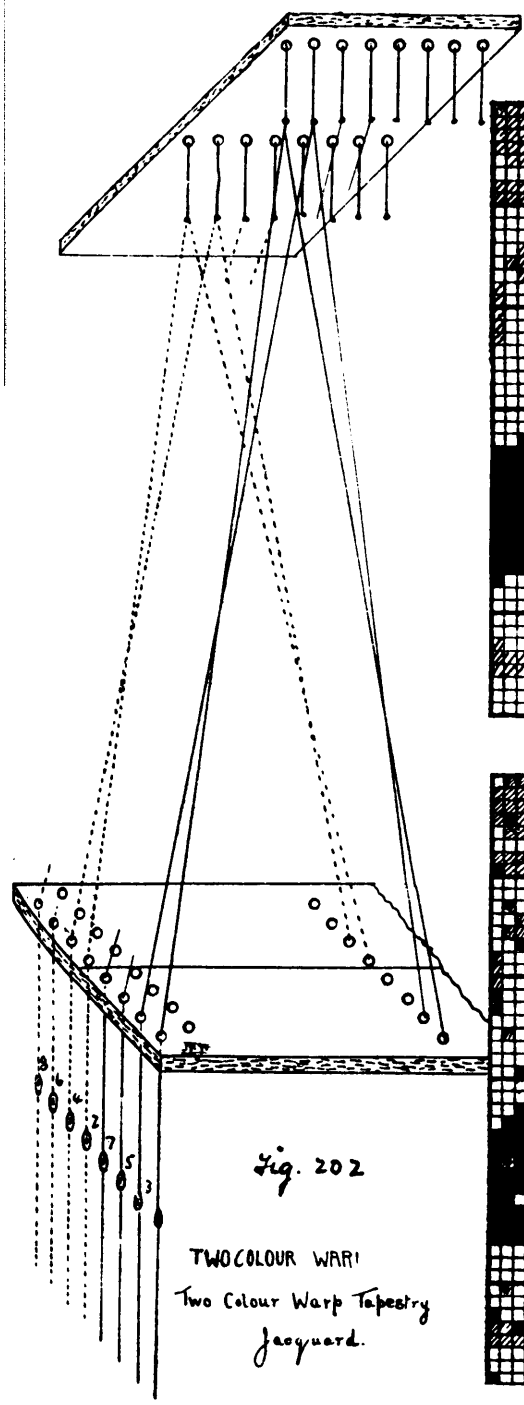
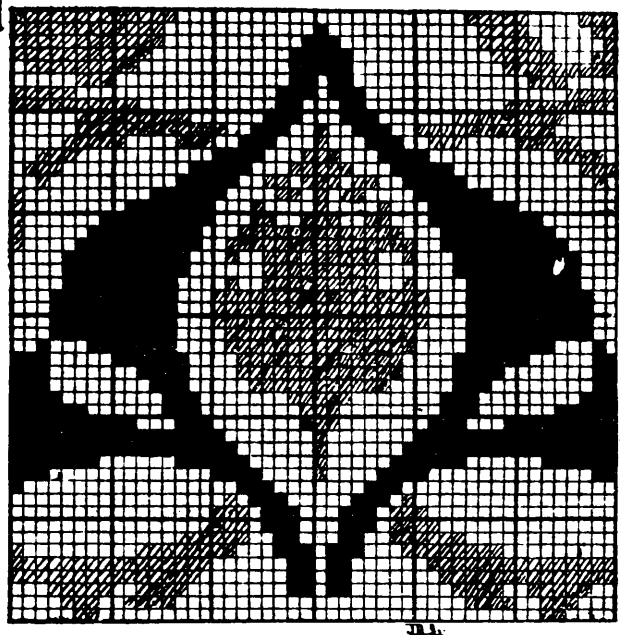

Fig. 202

TWOCOLOUR WARP
Two Colour Warp Tapestry
Jacquard.

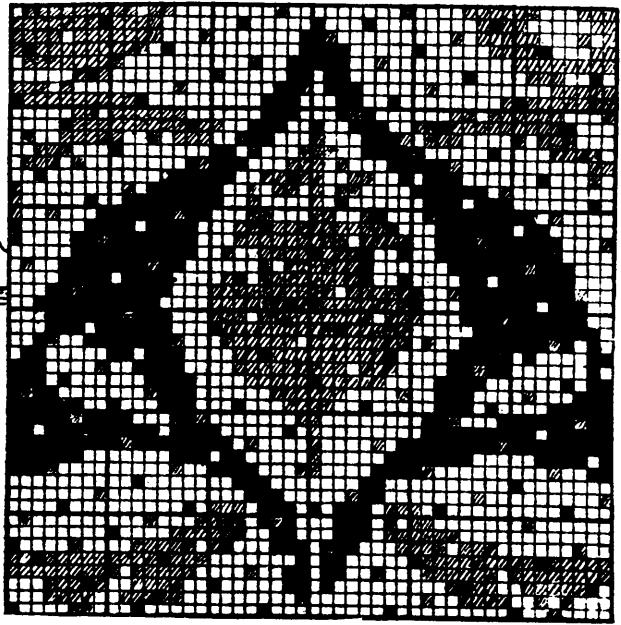

Fig. 204

100 green is left down for binding face and red lifted for binding back.
See Fig 204.

Two Warp and Two Weft Tapestry. Sometimes two warps and two wefts are used, each colour taking its part in the making of the pattern, in this case the pattern is painted up in four colours, two warps and two wefts as shown in Fig. 205 assuming that the two colours of warp are Brown \square and Blue \blacksquare and the two coloured wefts Sky \boxtimes and Red \square . A Jacquard tied up in two sections will be used.

The Brown warp to be worked by the first 200 hooks.

The Blue warp to be worked by the second 200 hooks.

The pattern on design paper will be 200 ends wide and each pick will be cut twice, once for the Sky pick and once for the Red pick. Turning the two parts of the machine the Brown machine and the red machine respectively, the card cutting will be

Sky pick no. 1a card, on the 1st part of card (Brown machine) cut brown and red. On second part of card (Blue machine) cut blue and red.

Red pick no. 1b. Card, on the 1st part of card (Brown machine) cut brown and Sky. On second part of card (Blue machine) cut blue and Sky.

It is advisable to use a binder warp worked by heads when using two or more coloured wefts.

Sometimes a binder weft is used along with a binder warp to bind the warp and weft floats, these garnes are very fine so that they do not interfere with the general design. In making coloured Tapestries, the Jacquard is divided into as many sections as coloured warps used, and each pick on design paper cut as many times as there are coloured wefts used.

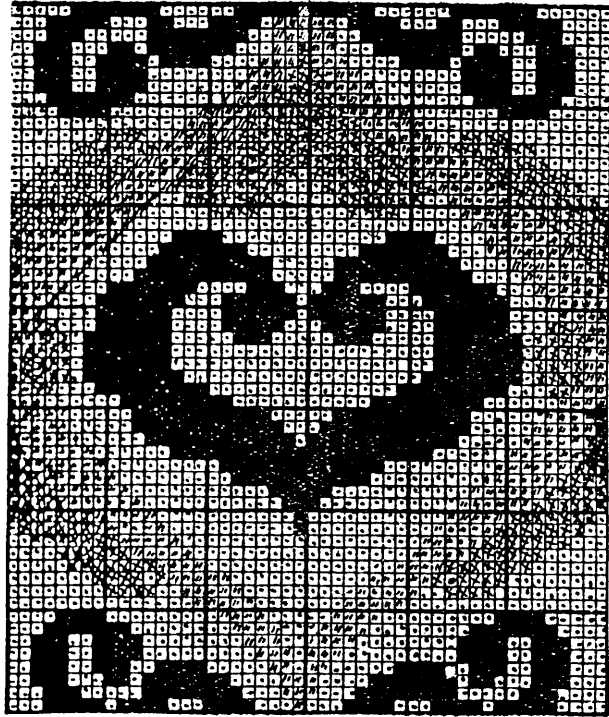
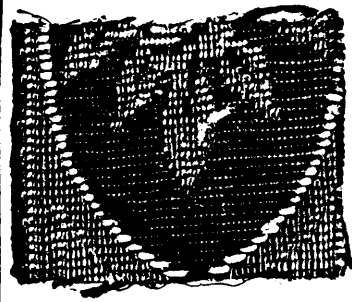

Fig. 205

101



Paint up Figs. 205 and 206
as 4 Colour Tapestries
2 Warp and 2 Weft.

Fig. 206

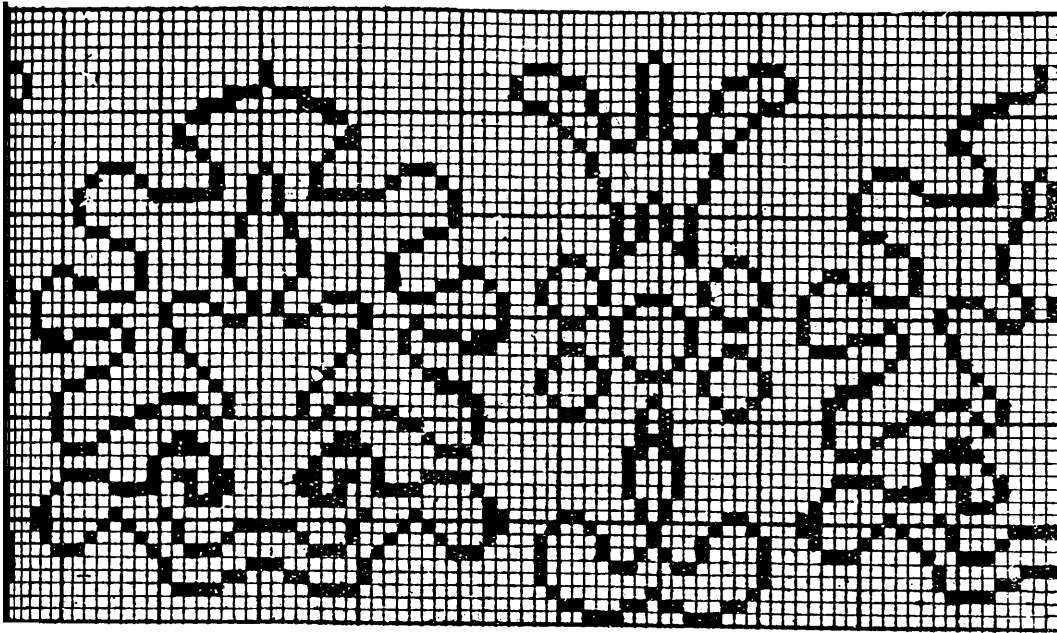

Six Shuttles Drop Skip - Box Motion.

In the making of heavy Tapestries and when using many different colours of weft, a strong shuttle box motion and a fast reed loom will be required. A suitable motion for the purpose is illustrated in Fig. 204, it consists of an arrangement of boxes 15 for six shuttles, any of the boxes can be brought on a line with the picker. A card cylinder 16 carrying flat steel cards, with blanks and perforations is brought to the feelers 3, an eccentric 4 fixed on the end of the bottom shaft of the loom works the upright rack 5 from the lever 6 with 7 as fulcrum; the card cylinder receives its motion from the tappet 8 and lever 9 with its fulcrum at 10. The lever 11 fulcrumed at 12 connects the upright rod 13 with the boxes and also through the rod 14 with the three eccentrics see Fig 208 and 209 1, 2, and 2^a. If the eccentric 1 receives a half turn the boxes are move one box, if 2 or 2^a receive a half turn the boxes move two. By arranging the cards to move the eccentrics singly or in combination the boxes may be made to move 1, 2, 3, 4 or 5 boxes as desired, the sketches below show the position of eccentrics and rod for bringing this about.

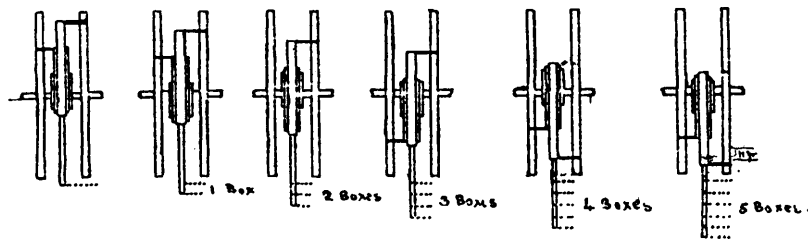

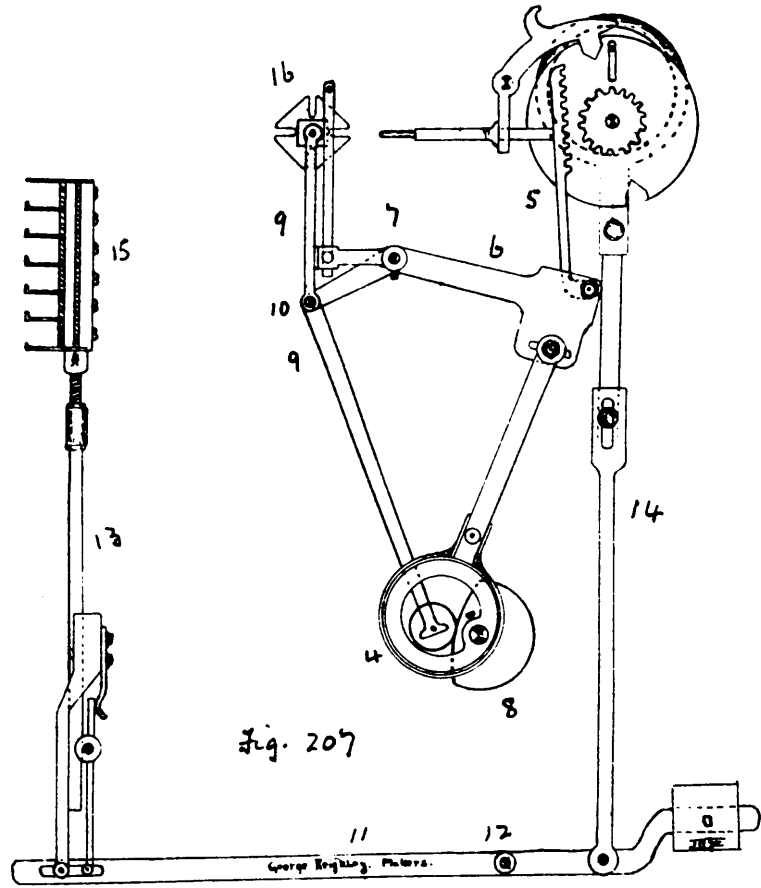

Fig. 207

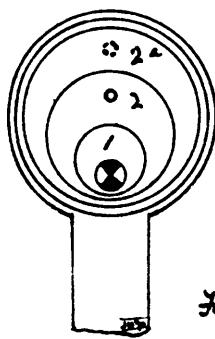

Fig. 209

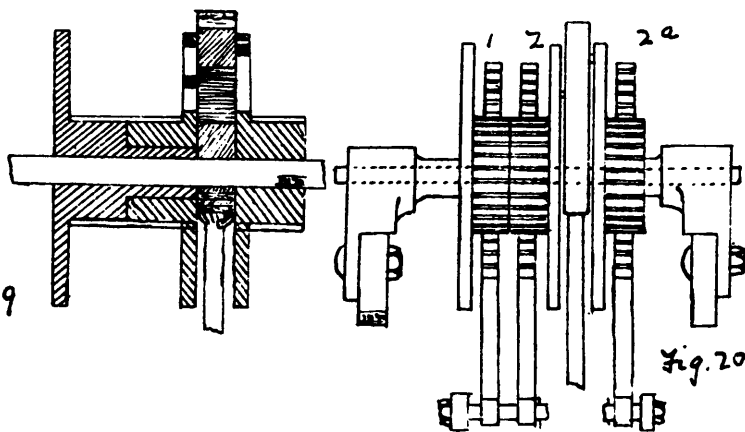

Fig. 208

Knowles chain Drop Skip Boxes. In this motion one box can be moved at a time or a box can be skipped as desired. In Fig. 210 two segment toothed wheels 1, 2 are driven by means of an upright shaft and bevel wheels, from the bottom shaft of the loom. The movable wheel 3 is under the control of a lever 4 and a pattern chain 5; the pin 6, fixed to 3 connects 7 with the lever 8 and 8 is connected with a chain 9 to the shuttle boxes; another movable wheel situated behind 3 is connected through 10 to the lever 11. To the other end of 11 is fixed a grooved pulley 12 over which the chain from the boxes pass. By moving the levers 8 and 11 in and out through the connections 7 and 10 and the pins on the movable wheels, any desired change of boxes may be obtained, this is illustrated by the diagrams Figs 211

Another Drop Skip box motion worked on the eccentric wheel principle is illustrated in Figs 212 and 213. wheels 1 and 2 are constantly revolving in the direction shown being driven from the crank shaft; a third wheel 3 fixed to a lever 4 with its fulcrum at 6 can be moved into gear with 1 or 2 when a change of boxes is desired by means of levers worked from the card cylinder 5; gearing with wheel 3 is another wheel 6' carrying studs to which the arms 7 are connected, these arms 7 are secured to a compound lever 8 with fulcrums at 9 and 10. to move one box the arm 7' Fig 213 works the lever about the fulcrum 10 and to move two boxes arm 7 works the lever about the fulcrum 9; to move three boxes 7 and 7' work together. The link and lever, 11 and 12 connect the compound lever to the boxes. As will be seen Fig. 213 there are two compound levers each with two sets of arms, one working the boxes on the right side of the loom and the other working the boxes on the left side of the loom, through the shaft 14 which goes across the loom.

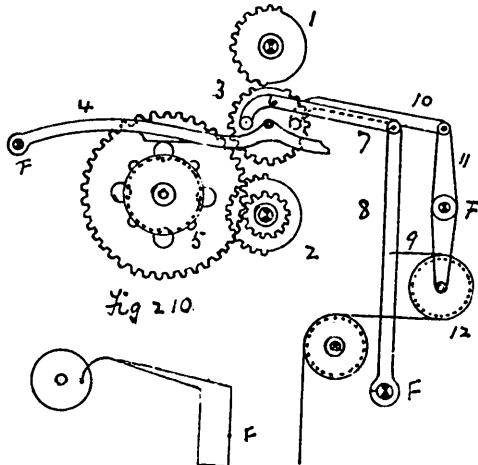

Fig. 210

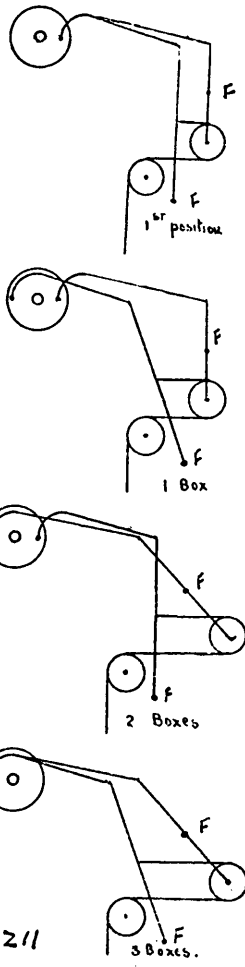

Fig. 211

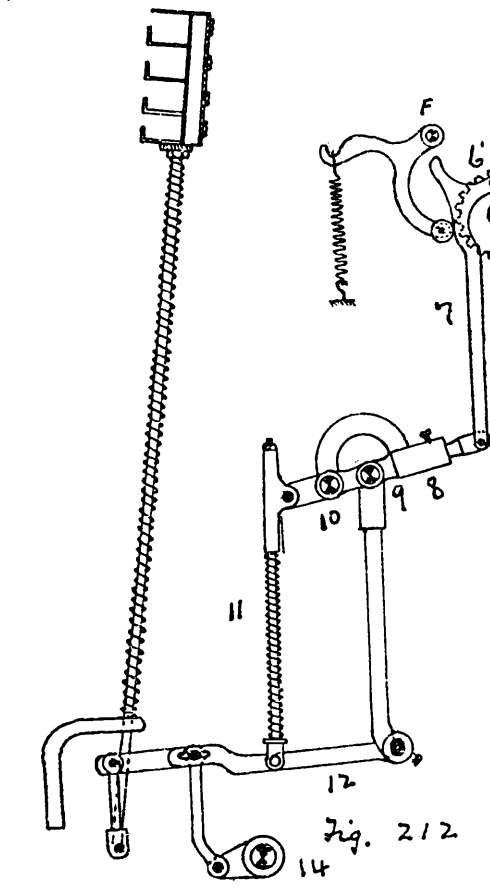

Fig. 212

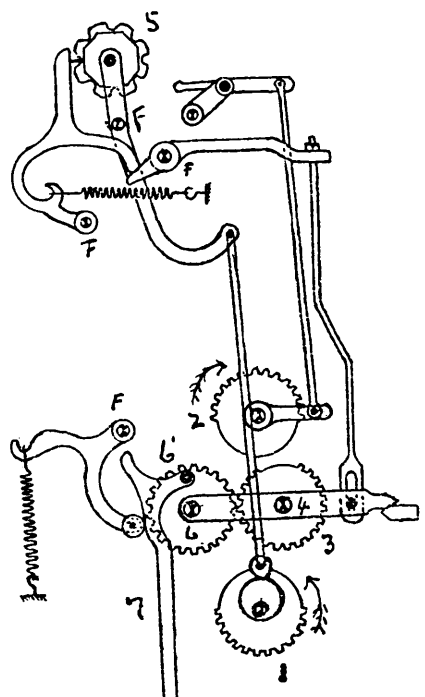

Fig. 213

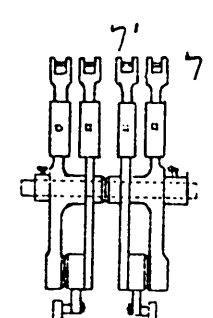

Fig. 214

Cross Border and Card Saving Motions applied to Box Looms.

In the Circular skip box loom there are two card cylinders, one of which carries the cards for the body of cloth and the other for the cross border Fig. 214. In addition to the usual levers for revolving the shuttle boxes the following parts are added as shown in Fig. 214 for addition to the two cylinders there is a smaller cylinder B. this cylinder carries a pegged lattice, a peg lifts the lever 7 and through the connections 6, 5 and 4 pulls the rod 3 backward, which action is the means of taking the haul which turns cylinder B out of action and permits haul which turns cylinder A to go into action. A blank on 8 lowers 7 and through the connections shown pushes rod 3 forward, this action takes the haul out of gear with cylinder B and at the same time allows the haul of cylinder A to come into action, so that blanks and pegs on cylinder B determines which of the two cylinders shall be working, by this means one cylinder can be kept in action for any number of picks

"Eccles" or Cowburn & Peck's "Card Saver" and Reversing Motion"
 Figs. 215 and 216 this attachment is applied to the box motion Fig. 113 page 63. An extra card cylinder is added which carries a lattice of blanks and pegs; two star wheels 1 and 2 are used for turning the ordinary card cylinder 3; by means of pegs and blanks acting on the bell crank lever 4, 5 the turning pins can gear with 1 or 2; in the sketch pin 6 is turning cylinder, a peg on A will put 7 into action with 2 and reverse the motion of the cylinder 3. A slightly thicker lag on A will put both pins out of action with 1 and 2 and allow a card on 3 to act for any number of picks.

108 Centre Weft Fork Motions. These motions are applied to pick and kick looms when single picks of coloured weft are inserted; the fork is fixed to the sley in the middle of the loom and moves too and fro along with it. In Fig. 217 when the sley is to the heads the slide 1 is pulled in the direction shown, this brings the two inclines 2 and 3 underneath the projections 4 and 5 on the weft fork and so lifts the fork into the shed. If the fork is then held up by the weft the loom goes on weaving, but if the weft is absent the projection 4 falls into the hollow of the incline 2 and locks the slide, the end of the rod 6 is pushed through its bearings and acting on a lever stops the loom. Another type is illustrated in Fig. 218. 1 is the shuttle race of the loom, 2 the prongs of the fork with fulcrum at 3. 4 is a slide for the slider 5; as the sley moves backward and forward it lowers and lifts the prongs of the weft fork owing to the piece 8 resting on it Fig. 219. This piece only just rests on 8, so that if 8 is lifted or kept up by the weft then 10 falls forward and the loom goes on running; if 10 is kept in its place however by the weft fork falling due to the lack of weft then the projection 11 on 10 comes against the bar 12 and turns the rod 13 which through the action of the lever 14 knocks the starting handle 15 out of position and stops the loom.

Another type showing end elevation is illustrated in Figs. 220, 221, 222 it consists of a sliding piece 1 which terminates in a rod 2 the end of which passes through a swivel bracket 3 fixed to the cross rail of the loom; when the sley is thrown back 1 passes beneath the fork holder 4 and lifts up the fork 5. If the weft is present as in Figs. 220 and 221 the fork is held up by the weft and the loom runs, if the weft is absent the fork falls down and 1 and 4 become locked Fig. 222 and the projection 6 strikes 7 which knocks the starting handle out of position and the loom stops.

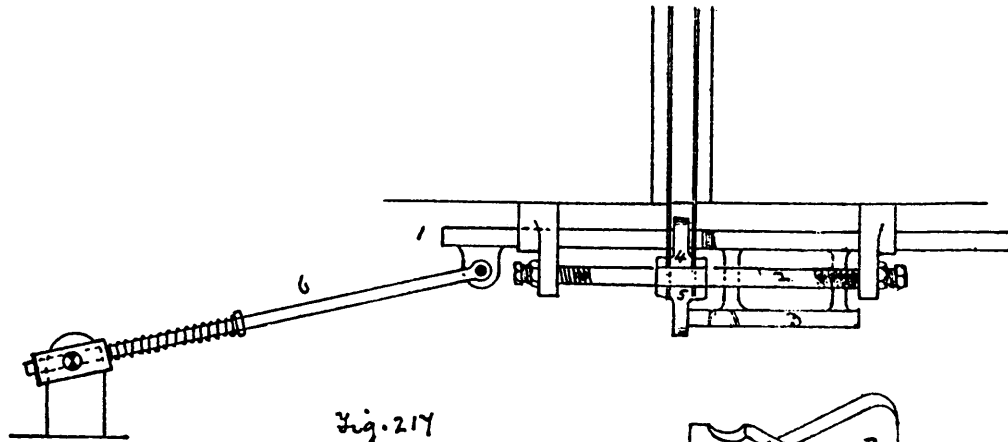

Fig. 217

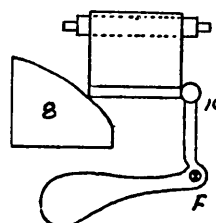
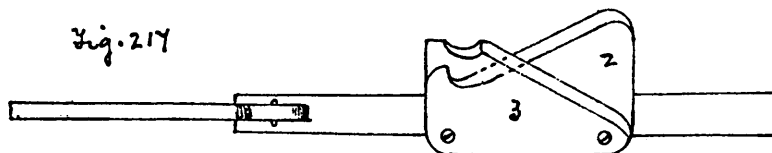

Fig. 219

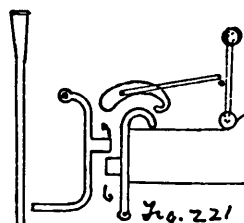

Fig. 220

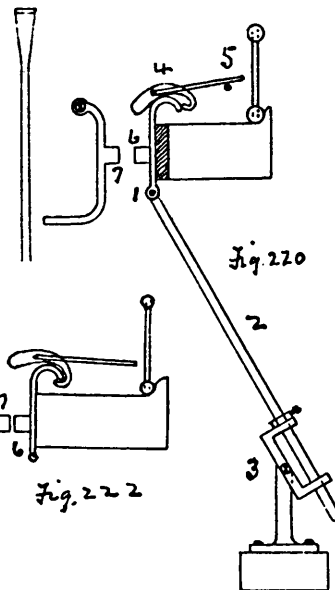

Fig. 221

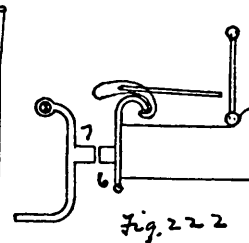

Fig. 222

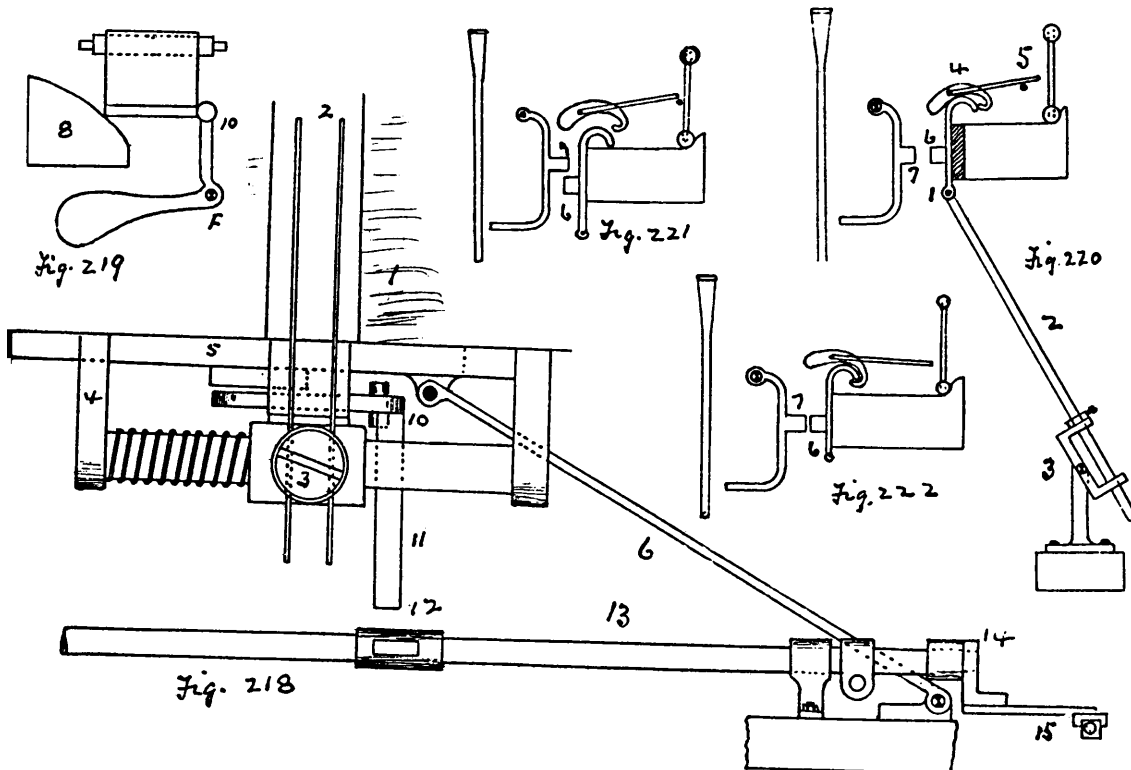

Fig. 218

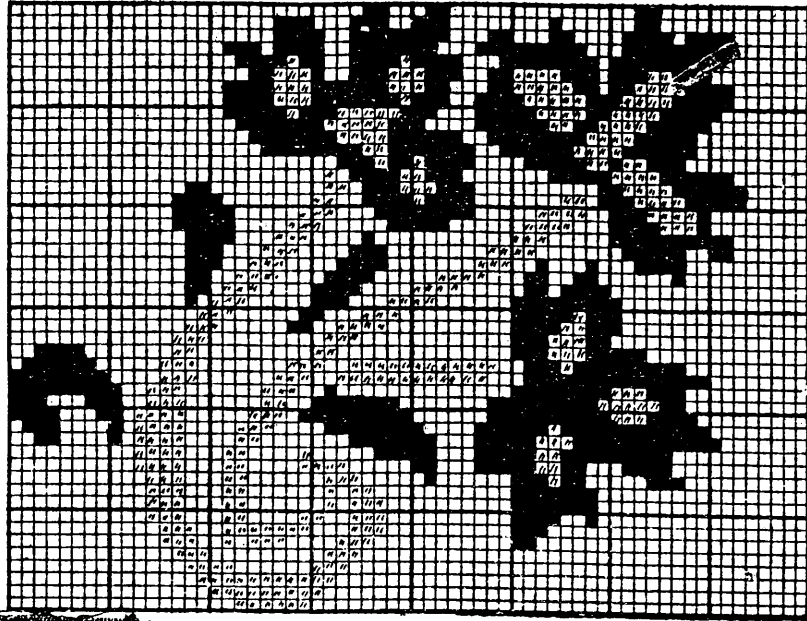
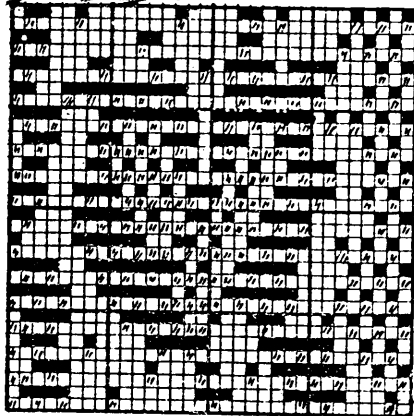
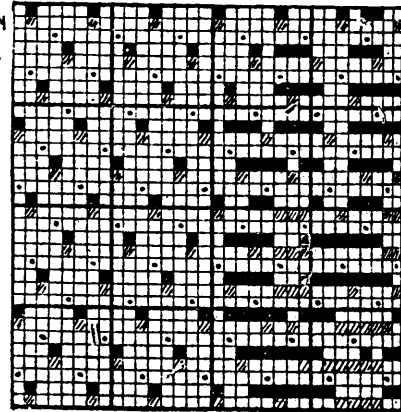

Fig. 223

225 SATIN
GROUND.224 SATIN
& REPP GROUND

Two and three weft Brocades made with one warp and two or three wefts in silk, artificial silk, wool, mercerized cotton or cotton, with one warp. Fig. 223 gives a pattern with white weft ■ dark green weft, with light green warp. Fig. 224 shows same developed in two weft one warp. Fig. 225 shows a portion in three weft, each example being pick and pick. Cut blanks in each case.

Wool Pile Fabrics, Figured Velvets. The Jacquard used for this type of cloth is of the ordinary construction namely. Double lift, one or two cylinders, straight or centre tie. The figure is developed in wool pile, and the wool when not wearing pile is floating loosely behind, or, a better plan is to weave it into the back in the opposite weave to the face. Fig. 226 shows both methods

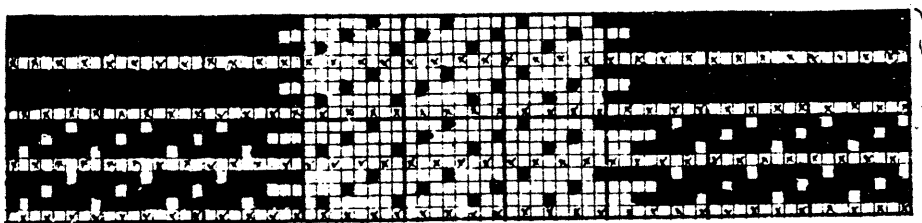

Fig 226

Another point to observe is, that at the margin of the figure the length of the wool float, must be sufficient to allow the cutters knife to enter, for that purpose the ^{float is} lengthened or shortened to suit this as shown in Figs. 226 to 229

In preparing a Jacquard design, one of the difficulties, is the proper ruling of design paper to use, as these cloths are made with many more picks than ends per inch; for example in a cloth with 80 ends and 320 picks per inch, the ruling of the design paper would be 8 by 32, but as this ruling would be too fine for practical use, some other method must be adopted. In Fig. 224 it is desired to develop the figure in velvet pile with 3 pile picks to one ground pick with a wool float of 5 and a plain ground, each square \square represents a tuft of pile and as the weave for 4 picks and 6 ends represent 3 tufts of pile it follows that one square \square represents 2 ends and 4 picks; a block design is therefore made on paper to suit this;



112

80 ends divided by 2 = 40; 320 picks divided by 4 = 80, the design paper to use for the block design will be as 40 is to 80, and as the ruling threads way must be in 8^o the ruling self way will be $8 \times 80 \div 40 = 16$, a portion of the figure is shown in outline on this ruling of design paper in Fig. 228 This pattern is now transferred to design paper ruled 8 by 8 and each small square on the block design represents 2 ends and 4 picks, a portion of the design so transferred is shown in Fig. 229

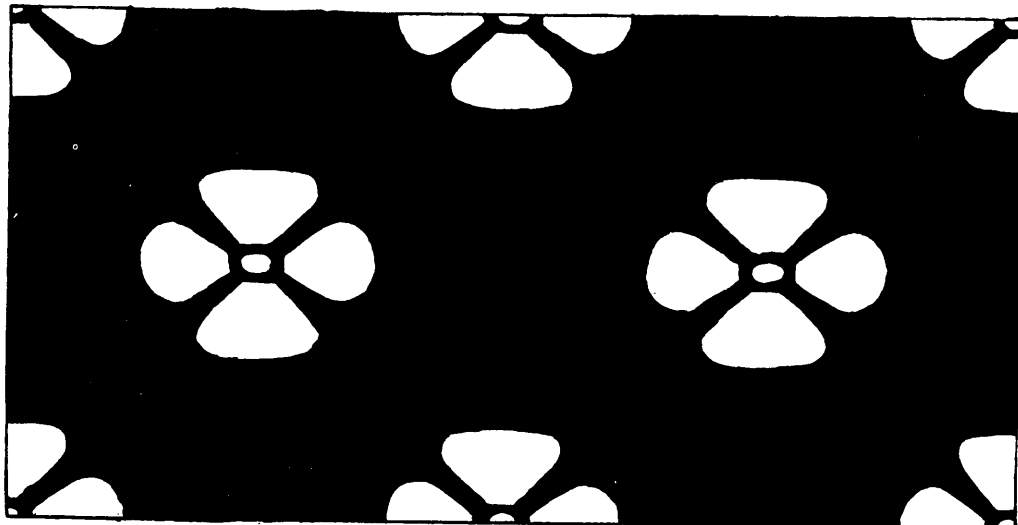
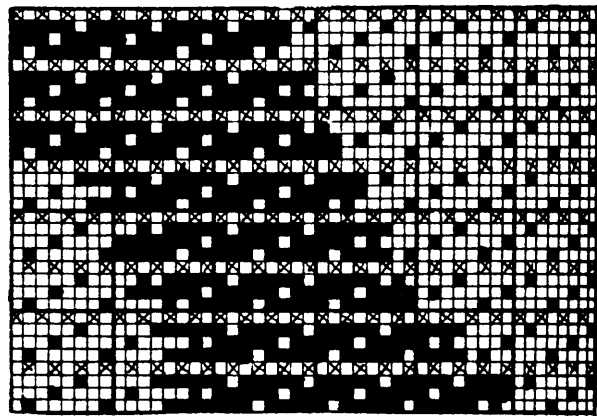
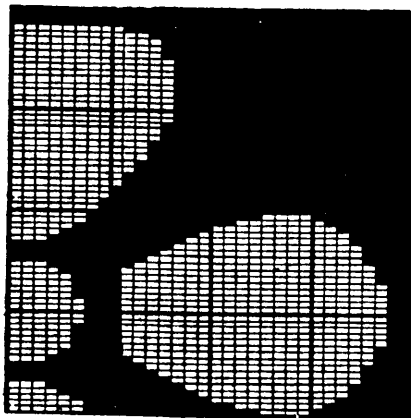
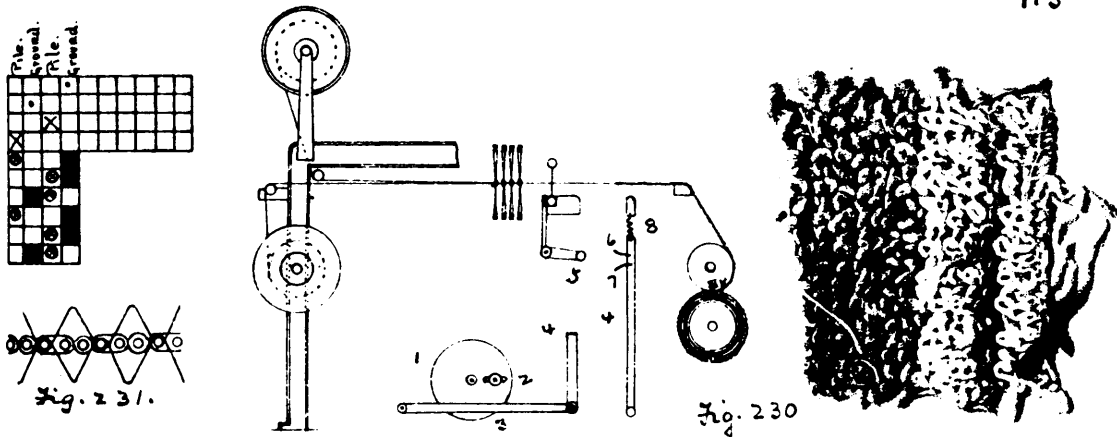

fig. 227

228

229





Ferry Weaving. Turkish Towels.

These cloths are well and largely used for towels on account of their spongy nature. A portion of the warp is brought to the face and back in the form of loops. It is a pile cloth made without the aid of wires, two warps are used Fig. 230 the pile warp is placed above the loom and is held quite slack, the ground warp is placed in the usual position and is held tight. The pile is made by allowing the reed to give way for two picks, on the third pick it is held firm as in a fast reed loom and brings up the pile warp in the form of loops on one or both sides of the cloth, four healds are used and the ends are drawn in as in Fig. 231 the front two healds for the pile and the back two healds for the ground.

The mechanism for working the reed motion is shown in Fig. 230 A plate wheel 1 carrying a bowl 2 acts on a lever 3 every third pick and pulls down the rod 4 and the bowl 5 passing between 6 and 7 holds the reed firm, on the two intermediate picks spring 8 acts and lifts 4 and as the bowl enters between 6 and 7 the reed is forced out of position.

114 Another arrangement for working the reed motion when using a dobby is shown in Fig. 232. A spare jack 1 of the dobby is set apart for the purpose, the mechanism is very simple and self contained; a bell crank lever 2 with its fulcrum at 3 is fixed to the loom side and near to the front of the loom, a tappet 4 with a bowl 5 affixed is fixed to the sley sword and moves too and fro along with it. a lever 6 with fulcrum at 7 is also fixed to the sley sword, the upper end of 6 holds the reed in position, with the parts in the positions as shown in the sketch the reed is held firm, but when beating-up takes place the bowl 5 moves up the incline of 2 and the tappet 4 is forced into position as shown by the dotted lines 8 and the reed gives way, this action takes place for two picks, on the third pick a jack 1 of the dobby lifts cord 9 and places 2 in the position 10, shown in dotted lines, the bowl 5 then passes beneath 2 and holds the reed firm for the fast pick.

Another reed motion is shown in Fig. 233. 1 is the reed which is held fast and loose by the lifting of the dobby jack 3; when the parts are in the position shown the feeler 4 comes into contact with 5 when the sley is thrown back and the reed is held firm, the lever 4, 9 and 10 is fixed to the loom side, the bracket 7 which carries lever 5, 6 with fulcrum at 8 is fixed to the sley sword and moves too and fro along with it; when the rod 2 connected with jack 3 is lifted, working on the fulcrum 9 4 is pulled back and 10 pushed forward with the result that the end of it comes into contact with 6 and places the end 5 in a vertical position with the curved part under the pin 13 fixed to bracket 14, when the sley comes forward to

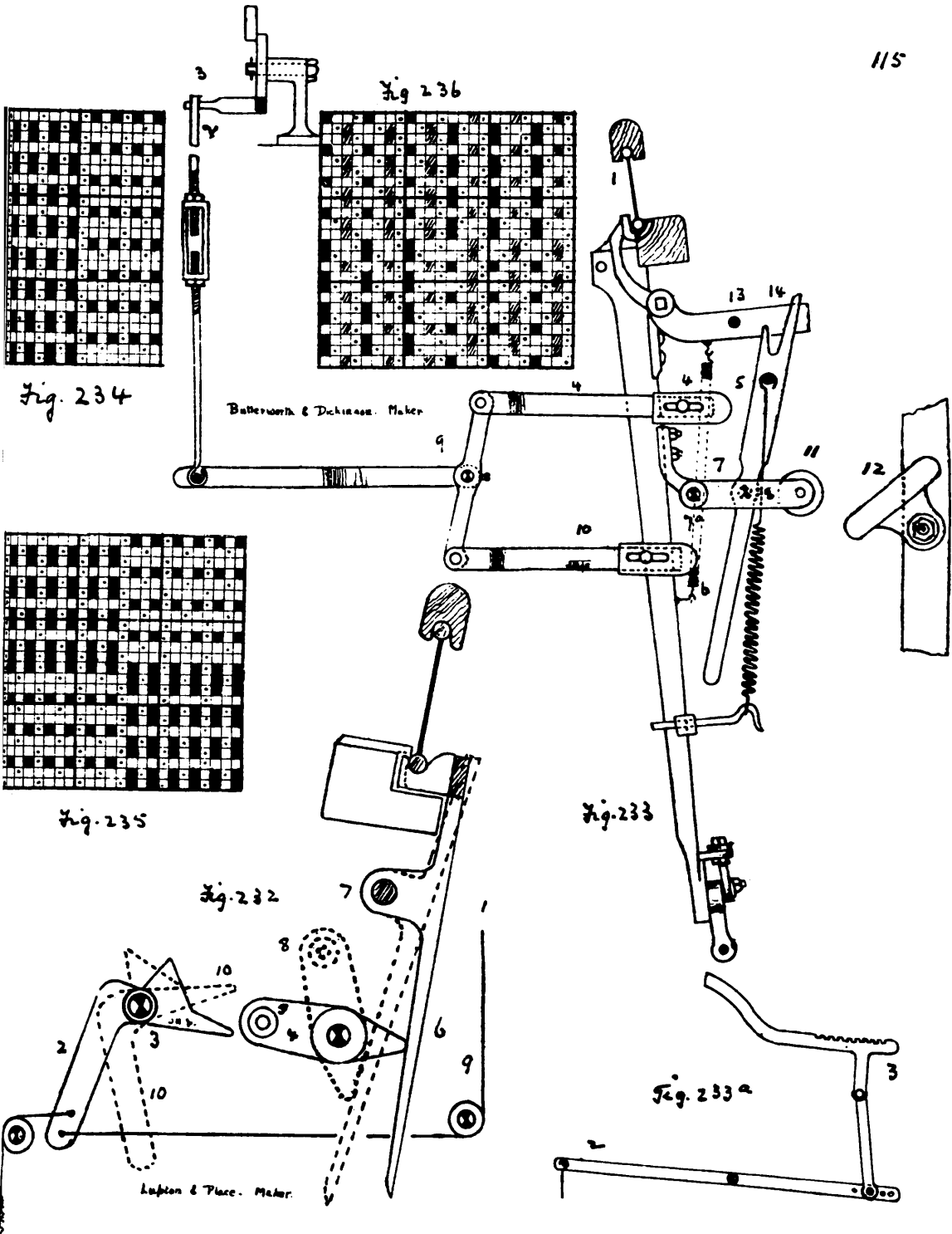

116 beat up the weft the bowl 11 travels up the inclined bracket 12
piced to the front of the loom and lifts the lever 5, 6 fulcrum
at 7^m and the pin and bracket 13, 14 forces the reed out
of position, this action takes place for two picks in succession

Fig. 234 gives a design for a stripe effect with terry on
face and back on alternate stripes. Fig. 235 gives a check
effect with terry on alternate checks.

Sometimes check effects are made with two colours of terry
warp say white and fawn and each check shows terry in
checks of white and fawn alternate, giving an all over
terry weave on both sides of the cloth. the ends are
arranged 1 ground 1 terry white 1 terry fawn and the design
is as shown in Fig. 236.

When these cloths are woven on a Jacquard, elaborate figuring
effects can be produced. Fig. 237 gives a design it is desired
to produce on a plain ground, the figure to be in terry weave,
the ground weave is woven by tappets and the pattern is
hainted up and cut on the cards as shown in Fig. 238 which
is a small portion of Fig. 237 where the weave is 2 up 1 down
the pile is showing on the face, when 2 down 1 up the pile
is showing on the back of the cloth.

When weaving a terry figure in one colour of warp and a
terry ground in another colour as in Fig. 236 by using a
Special Jacquards Fig. 239 a considerable saving of cards can
be made, the design is hainted up solid as in Fig. 240 and
one card serves for one complete terry weave of 3 picks. The
inventor W. Myers. Patent 28020. 1897 says Jacquards for weaving
figured reversible terry fabrics are so arranged that one needle,
such as N¹ controls two warp pile threads or sets of threads such as
P¹, W¹, and one Jacquard card controls one complete terry weave,
whether it be for 3, 4, 5 or 6 picks to the round. In the machine
shown each needle operates for hooks h¹, h², h³, h⁴ and the giffes

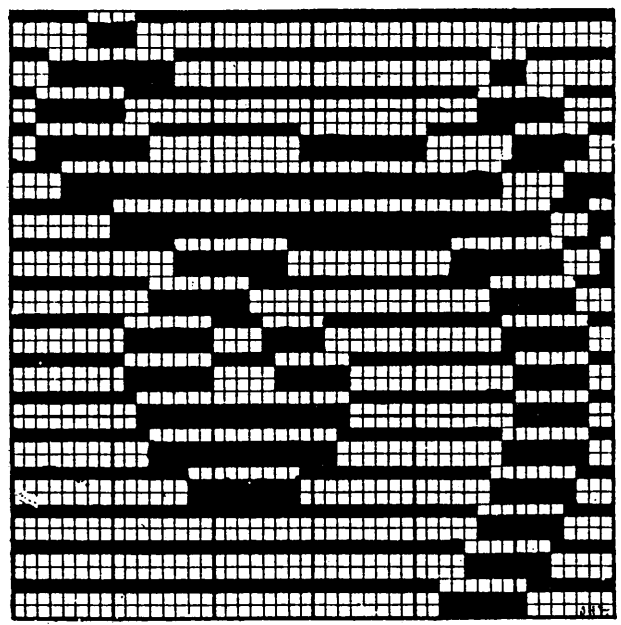
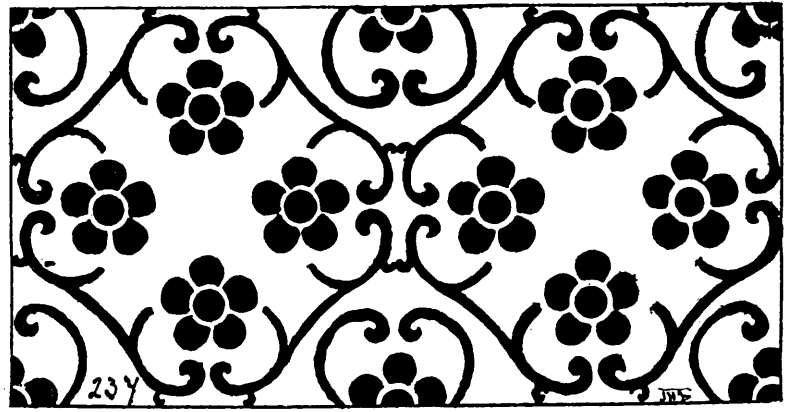
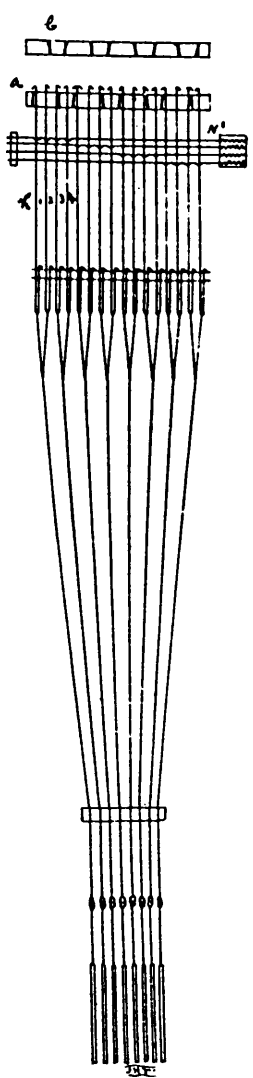
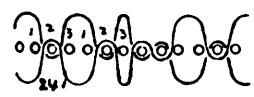

Fig. 240

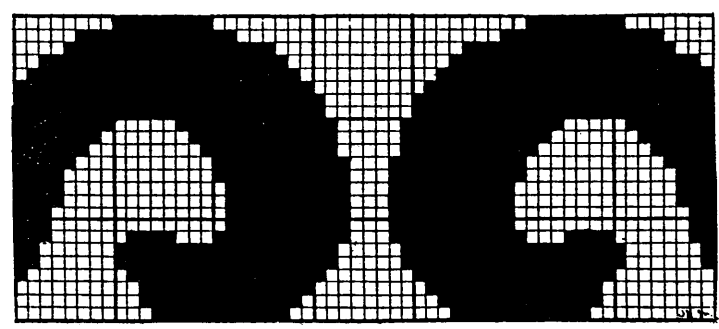



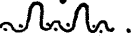
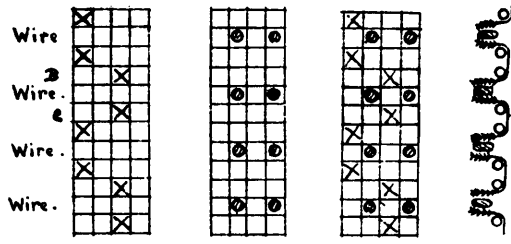

Fig. 239

118 a, b are so operated that when a is up b is down and vice versa.
If there is a blank in the card opposite the needle n' the giffle a will lift the warp thread w' on picks 1 and 3, and the giffle b will lift the warp thread w' on pick 2. This produces the fabric shown in the diagram Fig. 241 and a hole in the card causes the threads w, w' to change sides and produce the fabric shown in Fig. 241.

Warp Pile Cloths

Warp Pile Cloths. In these cloths the pile is made by the warp. the brush like appearance on the surface of the cloth is due to the insertion of a wire instead of a pick of weft there wires when cut out leaves the warp yarn standing erect on the face of the cloth, if the wires are withdrawn without cutting the warp loops are formed in the place of cut pile, the ground weave of many of these cloths is plain, but as seen from the back of the cloth  the reason for this is, for two picks the ground warp weaves plain cloth Fig. 242 the next two picks B. C. are alike, but a wire picks, occurs between these two picks the pile warp only being lifted and a wire inserted as shown at D; the pressure of the two picks upon the pile warp forces the wire to the surface of the cloth and causes the pile to stand more erect. A pattern for a pile cloth 1 pile end 1 ground end is shown in Fig. 243 in this example all the pile warp is lifted on each pick and the form of binding of the pile warp to the cloth is shown thus . It is not always advisable to lift all the pile warp on each pick, but to lift half the pile on alternate picks and secure the pile to the cloth by a loop  an example of such a cloth with a plain back is shown in Fig. 243 a section of this cloth is shown in Fig. 244 The non-cutting wires are of this shape  and when withdrawn make loop pile . In hand looms the cutting wires are made with a small



242^a 242^b 242^c

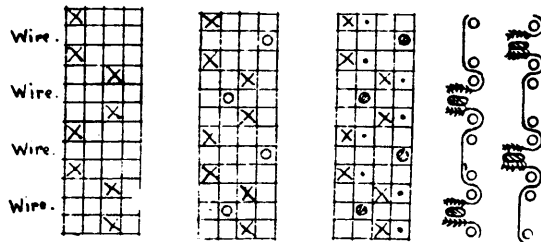

243^a 243^b 243^c

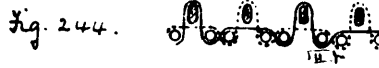
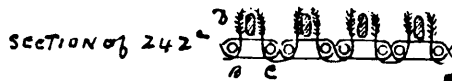

248 Part of 246 worked up
up Cut Pile Figure on
Plain Grad.

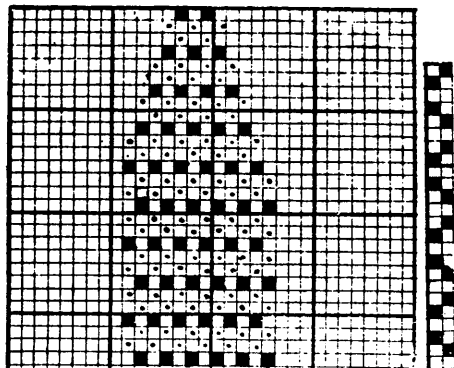

GROUND WAVE.

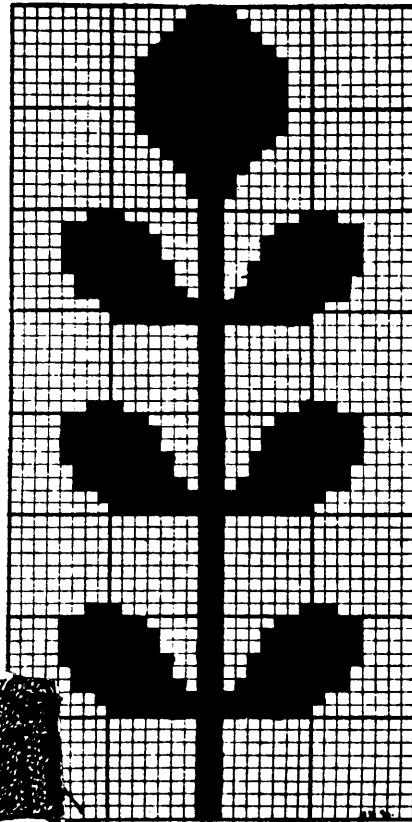

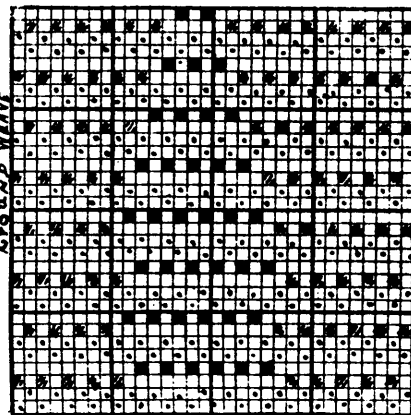

246 Warp Pile Design.



GROUND WAVE.

247. Part of 246 worked
up in Loop Pile Figure
and Cut Pile Grad.

groove along the top  or in two pieces  soldered together at the ends. These wires are cut out by running a small knife along the groove. When a Jacquard is used a great variety of patterns can be made by allowing the Jacquard to operate the pile warp and a set of healds the ground warp, different thicknesses of wire can be used to develop the figure in high and low pile, or by using cutting and not cutting wires in combination with each other, or by the development of pile figures on a plain, twill, satin or gauze ground, the pile warp when not figuring on the face is floating loosely behind the cloth, or it may be allowed to weave in some simple weave and when the cloth is taken out of the loom the loose material is easily pulled away as waste. Another fruitful source of design is the making of patterns in loop and cut pile, where the figure in loop and cut pile appears to be continuous across the piece, to produce this effect the wires are inserted as follows; part of the pile warp is lifted to produce the figure in loop pile and a non-cutting wire inserted, the shed is then closed and the rest of the pile warp lifted for the next pick and a cutting wire inserted with no ground pick of weft between the two wires, when the two wires are withdrawn after being woven into the cloth a line of cut and uncut pile will appear across the piece as in Fig. 245

In weaving figured pile on power looms, each pile end is wound on a separate bobbin and the same are arranged in a bed creel, the ends from the bobbins are drawn through the hammers of the Jacquard and the ground warp, which is on a separate beam, is drawn through the healds, both the healds and the Jacquard are worked by positive tappets. A wire motion Fig. 246 is used for inserting and withdrawing the wires on pile picks, the wires are inserted at the same time as a pick of

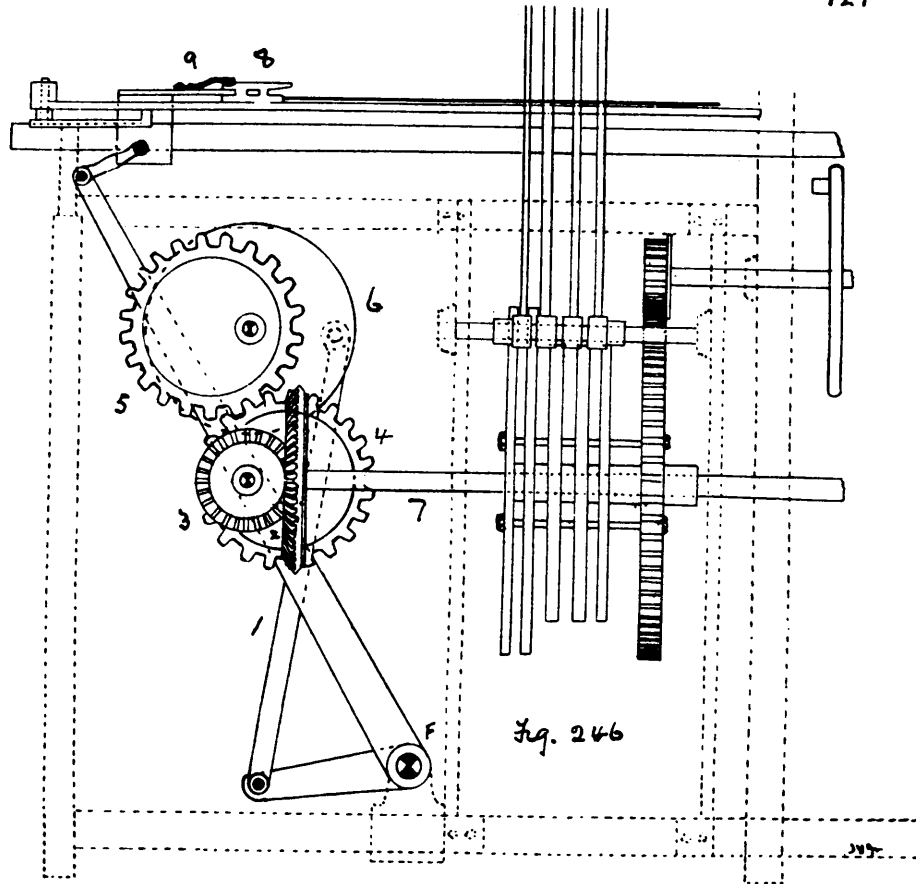
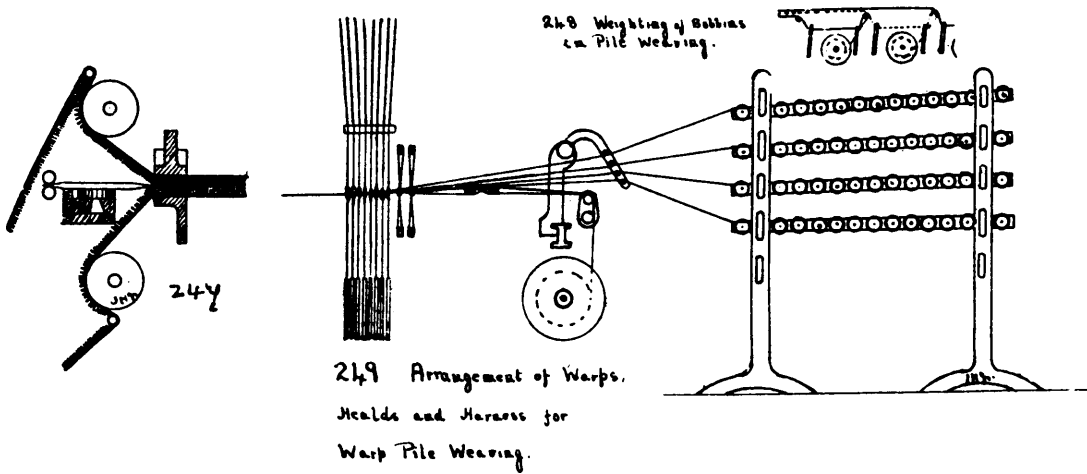
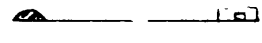

Fig. 246



248 Weighing of Bobbins on Pile Weaving.

249 Arrangement of Warps. Healds and Harness for Warp Pile Weaving.

weft, two sheds being formed for the purpose, the Jacquard giving a much greater lift than the ground healds. The wires are inserted by a moving arm worked by a train of wheels 2, 3, 4, 5 and plate wheel 6 from the bottom shaft 7 of the loom; each wire is provided with a head 8 and the arm with a projection 9 which seizes the wire and pushes it into the shed and as it returns it brings one of the previously inserted wires back again. As before stated the wires are of two kinds those for making cut pile having a small cutting knife at the end  and those for loop pile without a knife. In placing the patterns on design paper, the ground weave is not put in but only the pattern for the pile warp is painted, there are two weavers employed depending upon whether the pile is required to be cut or loop pile, this is shown on design paper.

Another method of making loop pile fabrics is to weave two cloths face to face as shown in section Fig. 247. A positive uniform let-off for the warp pile must be maintained to keep the length of pile uniform throughout, the pile is cut in the loom Fig. by giving to a long sharp knife suitably and rigidly mounted a slight to and fro movement, as the knife loses its cutting edge it is changed for a sharper one.

Carpets. Tapestry carpets are loop pile fabrics of a simple weave woven by healds, the ornamentation being obtained by printing the patterns required on the warp, making due allowance for the amount of take up required by the wires. The patterns are liable to be somewhat blurred and not very distinct in outline.

In Brussels Carpets the design is developed in loop pile in different coloured warp threads, these threads when not on the face weaving figure are running straightwise in the cloth and acting as padding or stuffing. The irregular

take up of the different pile threads require that each pile end shall be wound on a separate bobbin, there is usually a separate frame for each colour of pile end, and a 5 colour carpet is spoken of as a 5 frame carpet. In addition to the pile warp there is also a ground warp and a stuffing warp each wound on to separate beams and controlled by tappets. The Jacquard controls the pile warp, and as this warp is required to serve as a stuffing warp when not figuring, it must always lie on the top of the ground warp or at least between the ground warp and the pile; on wire hicks therefore the pile warp is lifted on a line with the top shed of the ground weave by the bottom board or by means of knotted harness and a lift or comb board, and the hooks required to be lifted for the wire hick receive a further lift by the Jacquard gripper and the weft hick for the ground and the wire hick are inserted simultaneously but in different sheds. In designing, the pattern is painted up on design paper in the colours of the warp and the Jacquard is divided into as many parts as there are colours, each colour is cut on its own part of the card, by this means the colours are brought up into the warp in the order of the colours to suit the pattern. No ground or stuffing warp is shown on design paper. Other types of carpets are woven after the style two or three ply cloths with stuffing or hadding warps and wefts. The Kidderminster or Scotch or Ingrain Carpet is a two or three ply carpet with different colours of warp and weft.

Amminster Carpets are pile carpets but the pile is made by using chenille weft, which is wool weft prepared by weaving wool weft in a loom with hair of fine cotton ends weaving hure gauze and afterwards cutting into lengths fig. 252 and using it for weft, a rather expensive process.



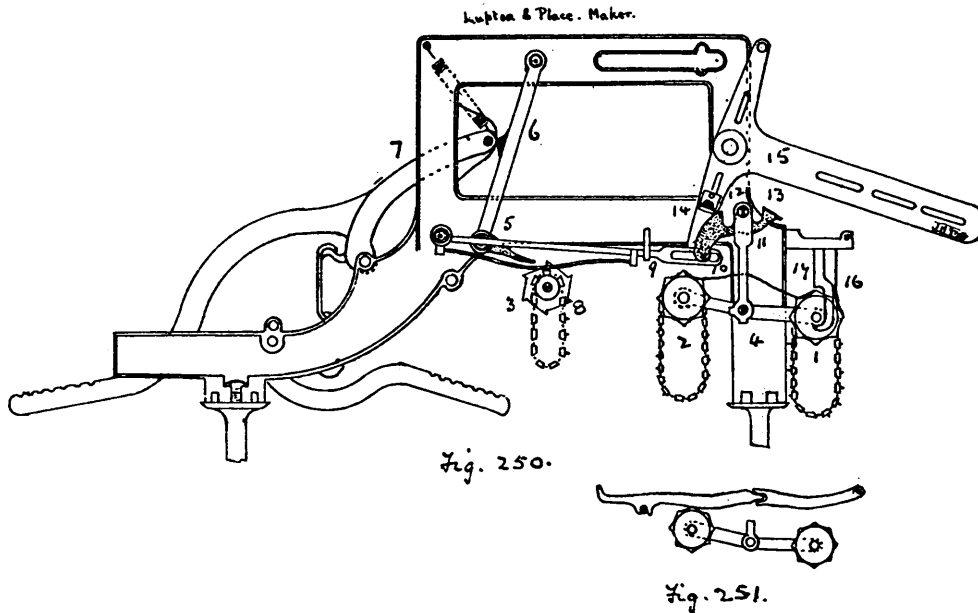

Cross Border Dobby. In weaving Terry towels, Cross borders for squares and cloths of similiar character, the Cross Border motion invented by R. H. Place, is both simple and efficient. Fig. 250 "It consists of two hattern cylinders 1 & 2 mounted upon the oscillating **T** lever 4 there are brought into action alternately by a third hattern cylinder 3, which is operated by a pawl 5 on a spring lever 6 under the control of the end baulk 7 of the doily. The hattern chain 8 by means of a spring operates a lever 9 which has a slotted end 10 to actuate a tumbler lever 11 and bring either of its catches 12 and 13 into engagement with a lug 14 on the ordinary **T** lever 15. The lever 4 is held in its two positions by springs 16 and the extent of its movement is limited by a bracket 17". 251 Shows 1 & 2 working the levers.

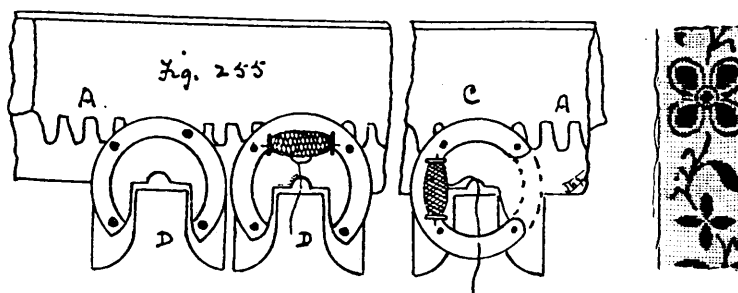
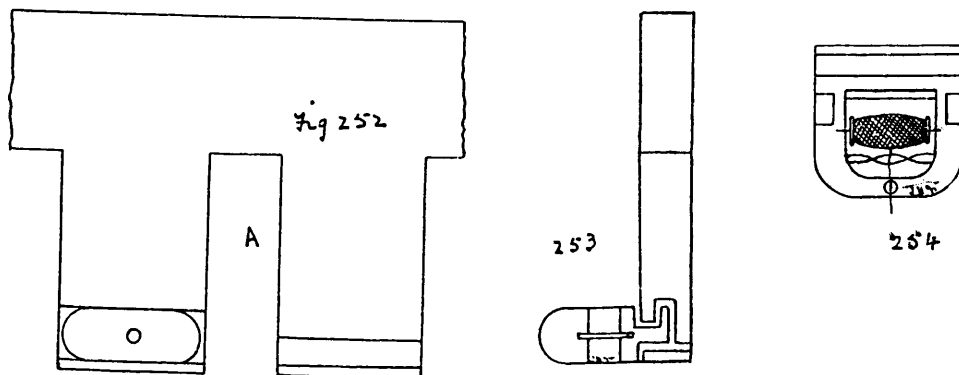

Swivel Weaving. Extra weft shot figures are often made in an ordinary circular or Drop box loom, but this method causes considerable waste of material, as when the extra weft is not forming figure it is floating loosely behind the cloth and must afterwards be cut away by a shearing process, when using expensive wefts as silk a much better arrangement is to use Swivel shuttles, these are small shuttles fitted in a movable frame and the whole arrangement connected to the Sley cap of the loom, in using these shuttles very little more weft is taken up than what is actually required to produce the figure. Figs. 252. 253. 254 illustrates the shuttle, which is about 3" long, and the method of mounting it when applied to Handlooms Fig. 252 a front view. Fig. 253 a side view. Fig. 254 a plan of the shuttle; when a shed is formed for the extra weft figure, the threads are lifted into the opening A (Fig. 252) and the shuttle is

slid across the opening beneath the lifted threads. The space that each shuttle occupies determines the distance the figures must be apart, as there can only be an extra spot opposite to each opening A. By using Circular Swivel shuttles the figures may be set closer together, the shape of the shuttles and their action may be explained by Fig. 255 the threads are lifted into the opening D and by means of a toothed rack A the shuttles are turned completely round, the weft bobbin passing underneath the lifted ends. C shows the shuttle in the act of turning.

Figs. 256 to 259 illustrate the arrangement when swivel shuttles are applied to power looms Rirchenough and wood-katantees. Fig. 256 shows the arrangement of the shuttles in the lay; it consists of a sliding rack 9 fixed to a frame which can be raised and lowered as required, a reciprocating motion is given to the rack, the teeth of which engage with a small pinion 2, the movement of the pinions are transmitted to the shuttles 3, moving them across the opening 4, the pinions are never out of gear with the shuttles this ensures a positive motion. A roller shaft 6 Figs. 256-257 is fixed to the sley sword of the loom, connected to the rollers are straps 7 and 7^a these pass over guide pulleys 8 and 8^a and are attached to the rack 9; the roller 6 is given a rotary motion, first in one direction and then the other, the same movement as that given to the top roller motion for healds in a plain loom, this is brought about by a pair of tappets 10, 11 fixed to a counter shaft 12; the revolving of tappets gives the required reciprocating motion to the rack.

The raising and lowering of the rack is also worked through a tappet and lever from the counter shaft; the tappet 13 acting on the lever 14 Fig. 257 pulls down the rod 15, the rack 9 then falls with its own weight allowing the swivel shuttles to fall into a working position, when the tappet ceases to act

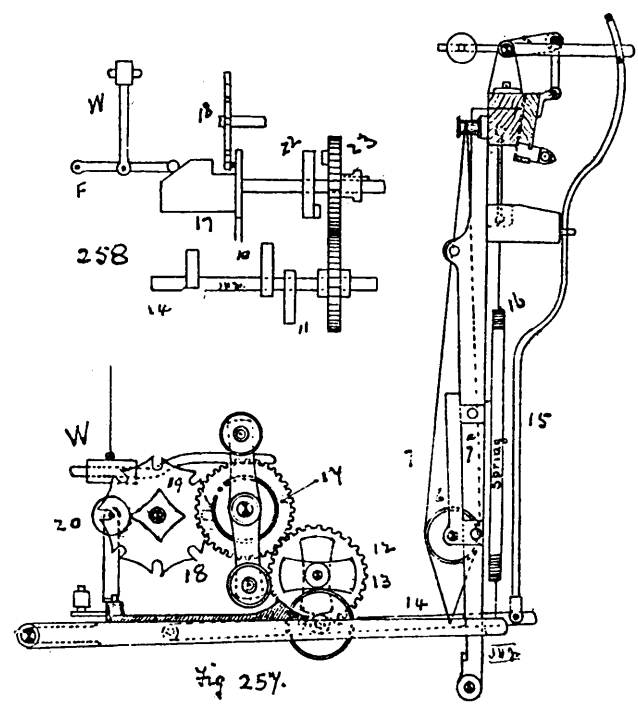

Fig. 254.

For the purpose of setting the Swivel motion in action a weighted lever W Fig 258 is connected to a spare hook of the Jacquard, when the lever is lifted the other end presses against a face cam surface of a slide peg wheel 17 and hits it out of action with the star wheel¹⁸ and the picking strikes at an empty box, this sliding of the peg wheel along the shaft puts a sliding bar²² with projections on its face into action with the wheel 23 this wheel gears with a similar wheel on the counter shaft which carries the tappets^{10, 11} for giving a reciprocating motion to the rack also for raising and lowering the rack.

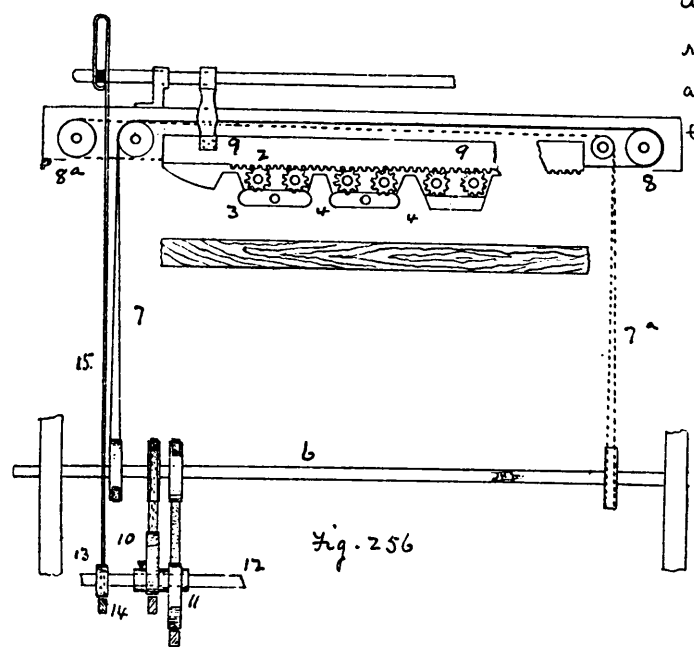

Fig. 256

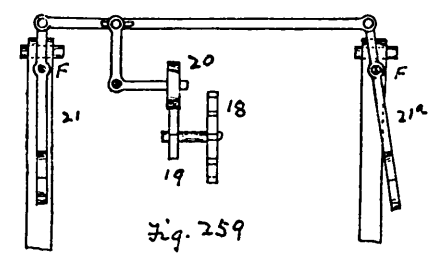
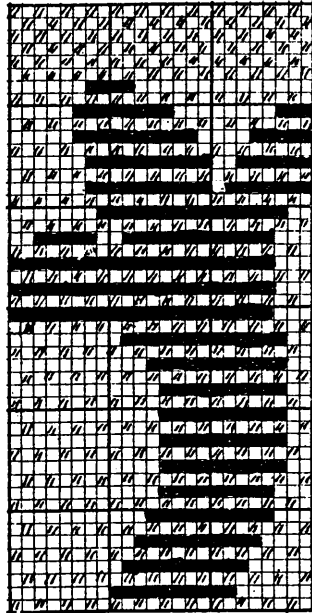

Fig. 259

the spring 16 lifts up the lever and consequently the racks with the swivel shuttles out of the way for the ground shuttles to work.

The picking of the ordinary ground shuttle is controlled by an Underpick Pick and Pick motion; on the bottom shaft of the loom is a slide peg wheel 17 engages with a star wheel 18. a pin on 17 engages with 18 and gives it an intermittent motion, on the same stud as 18 is a square boss 19, pressing against 19 and kept in contact with it by a spring is a bowl 20 fixed on the end of a bell crank lever (Fig. 259) the revolving of the star wheel is the means of hitting the picking saddles 21. 21^a alternately in position, say, when the corner of the square acts on the bowl, the picking takes place from the left hand side, when the flat side of the square acts on the bowl picking takes place from the right hand side.



261 A Part of 260 placed on Design Paper.

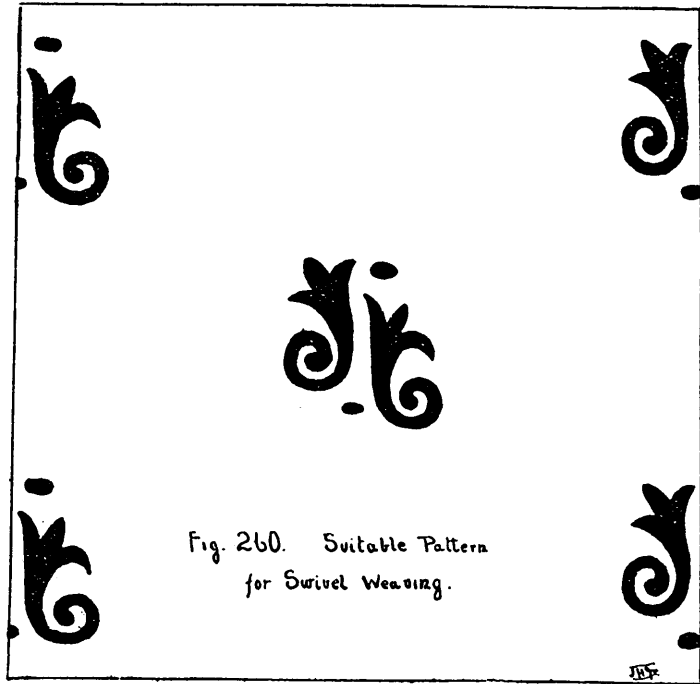
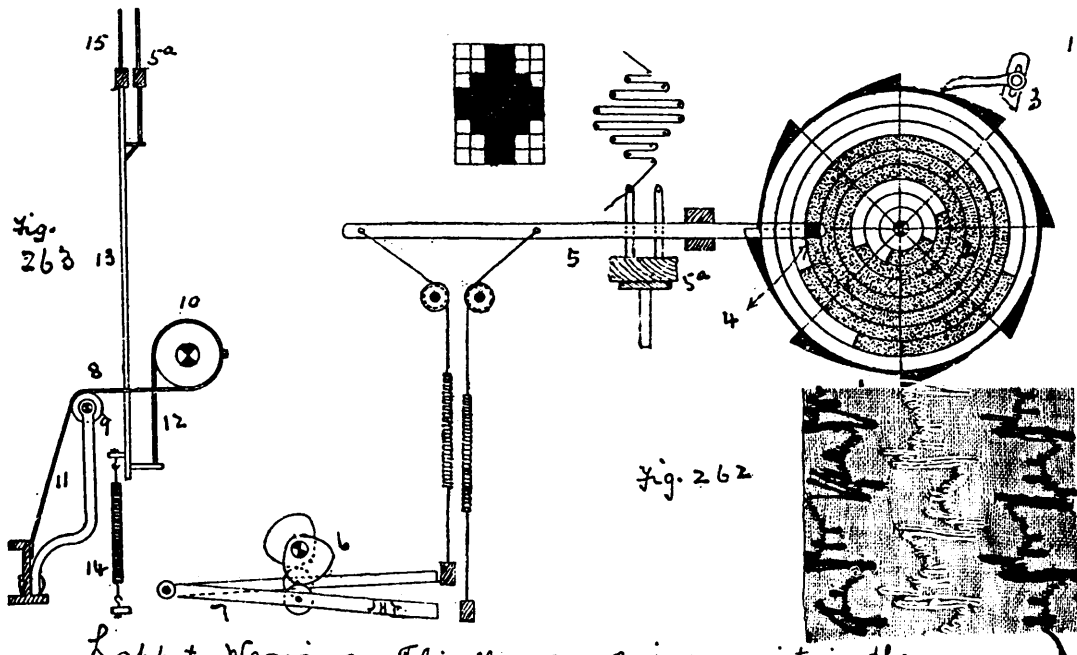

Fig. 260. Suitable Pattern for Swivel Weaving.



Lappet Weaving This class of weaving consists in the ornamentation of fabrics by means of extra warp, the extra warp being used for figuring only. The mechanism consists of a needle frame situated in front of the reed, it can be raised and lowered into the shed, it is provided with pins having a small eye at the top through which the extra warp is drawn, this frame is capable of being moved from side to side, the distance it can move in any direction determines the size and shape of the figure. The oldest system is known as the Scotch system illustrated in Figs. 262 & 263. A large wood wheel 1 (Fig. 262) is fixed to the sley at one side of the loom, a groove 2 is cut out of the face of the wheel; the wheel is driven by a hawl 3 one tooth every two picks, the pin 4 fixed to the needle frame 5 is moved from one side to the other of the groove; 5 receives a backward and forward horizontal motion from the tappets and treadles 6, 7. Fig. 263 shows the method of lifting the needle frame 5^a into the shed, 8 is a leather strap fixed to the front of the loom, it passes over a guide pulley 9 it is connected to a roller 10 fixed to the sley bar, a strap 11 passes around 12 in the opposite direction and is connected to the rod 13 which supports the needle frames when

130 the sley is thrown back the roller 10 is turned round due to the pull of the strap 11, this action winds up the strap 12 and lifts the needle frame 5^a into the shed; when the sley comes forward to beat up the weft the spring 14 comes into action and pulls down the needle frame. 15 is a row of pins or false reed against which the shuttle runs as it moves across the loom.

Fig. 267 shows the construction of a tappet wheel for the pattern Fig. 268, the wheel is divided into as many circles as there are ends in the pattern plus four for the fin and into as many teeth as there are picks in the pattern on design paper, then make the width of the groove opposite to each tooth equal to the number of ends in the pattern plus four extra for the fin.

Figs. 264, 265, 266 illustrates the mechanism for working the needle frame in Galloways motion, where the movement of the needle frame is determined by 36 different sizes of pegs, increasing in size from $\frac{3}{8}$ to $\frac{1}{2}$ in steps of $\frac{1}{32}$ rd part of an inch. In Fig. 264 is shown the barrel 1 which carries the pegged lattice it is fixed to the sley sword of the loom, a haul 2 fixed to the front of the loom pushes forward the barrel one tooth for each pick.

Fig. 265 gives a side elevation of four needle frames 1 and the bar 2 which serves as a false reed, it is fixed to an upright rod 3 which carries a pin 4 working in a grooved bracket 5 fixed to the cross rail of the loom, when the sley is thrown back the pin 4 moves up the slot and lifts the false reed and needle frames into the shed. Fig. 266 gives a front elevation of barrel 1 with the pegged lattice 2, a bell crank lever 3, 4 is fixed to the needle frame 5 it is moved too and fro by the different height of pegs which are brought underneath the end 6 of lever 3, 4. Fig. 269 gives the peg plan for the pattern Fig. 268 and the numbers along the top the different sizes of pegs to use on the respective picks to which they are opposite.

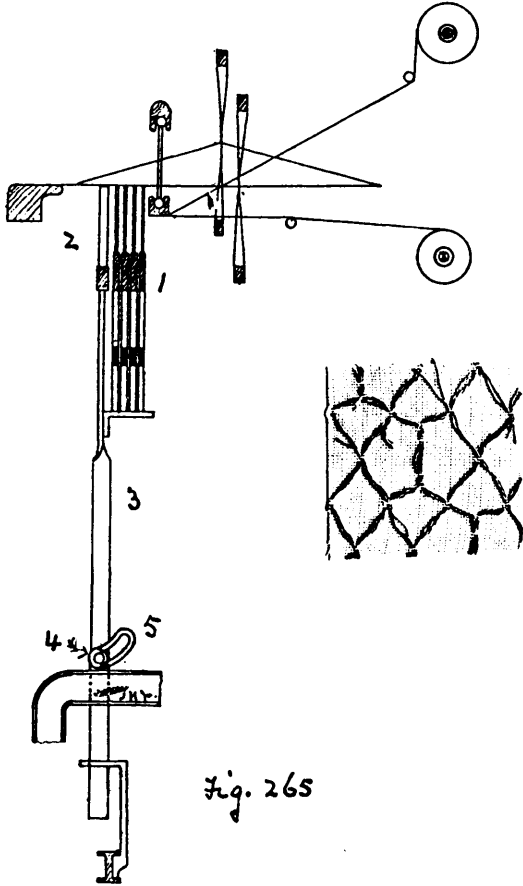

Fig. 265

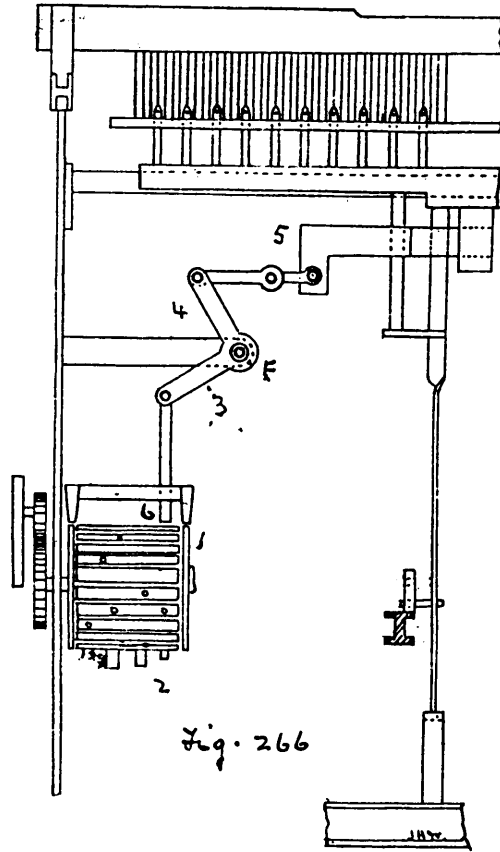

Fig. 266

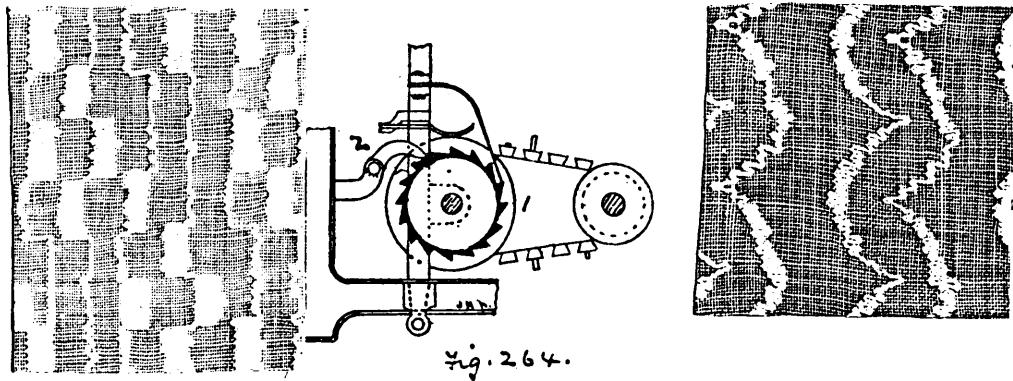

Fig. 264.

132

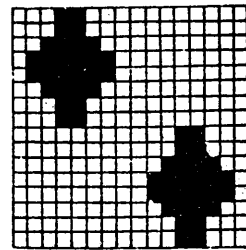
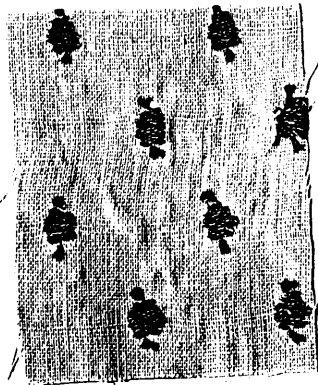
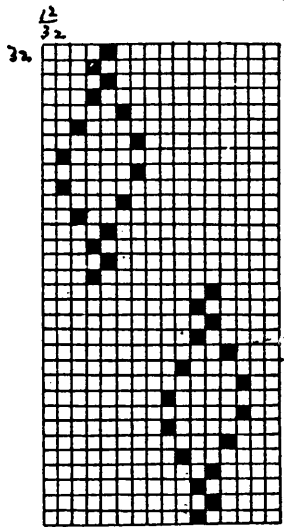
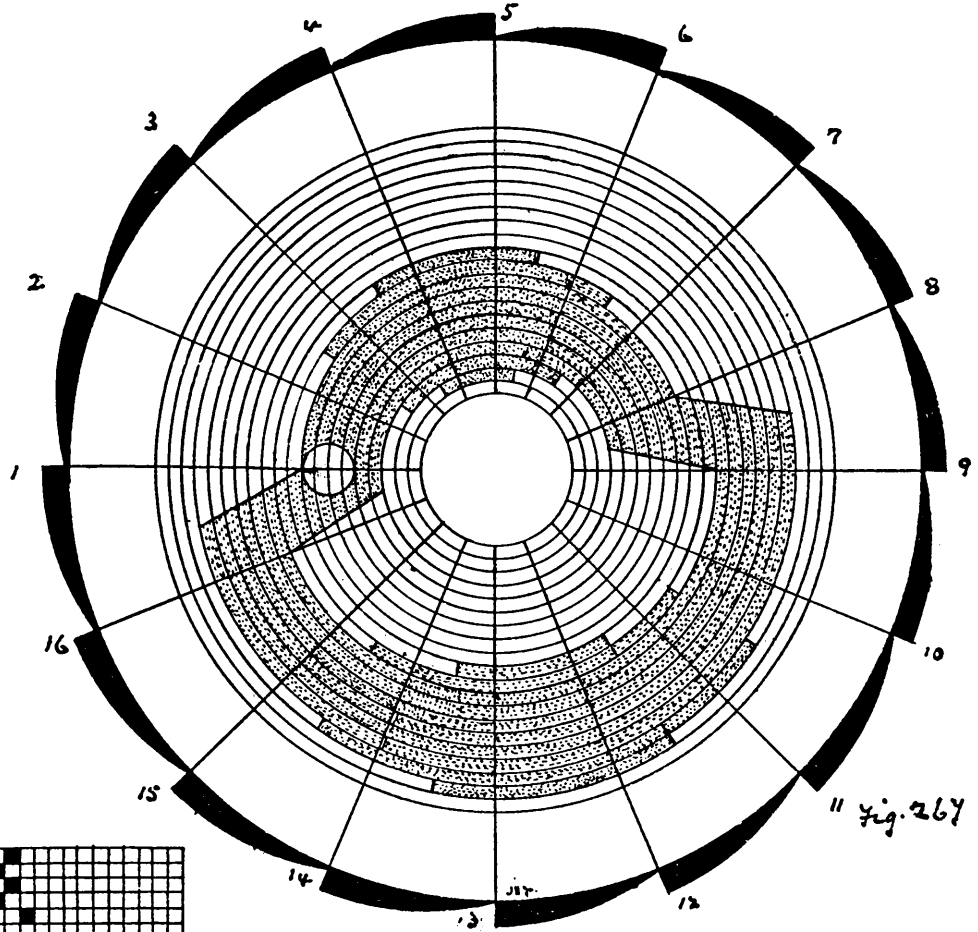

Fig. 268

Automatic Looms are of several types namely shuttle 133
changers and cop changers, also a type which run at full
speed during the change, others that slow down and others that
stop for a moment during change. So far as the mechanical
part is concerned there are a large number of looms of different
inventors which have solved the problem, it is now more a
question of cost, labour and production; almost in every
town in Lancashire where weaving is extensively carried on
inventors have been at work devising a loom to automatically
change the shuttle or the cop as the loom runs, and every
loom maker has one or more patents of their own for doing
the work.

In the Northrop Automatic loom the cop is changed with the
loom running at full speed, for that purpose the cops are
placed on shuttle pegs Fig. 270 the pegs have a round end of
wood covered with two or three coils of wire, this enables the
weaver to firmly grip the peg when skewering the cop. The Cop
changing mechanism consists of a large circular hopper,
fixed to the front of the loom (not to the Sley) capable of holding
28 cops, the skewered cops are placed in the hopper and held in
position by spring clips, the only motion of the hopper is circular
and each time that the weft is beaten up to the fell of the cloth, the
shuttle box is brought directly underneath the lowest cop in the
hopper. The action of the weft fork brings the change mechanism
into action as shown in Figs 271 and 272 connected to the weft
fork holder is a lever 1 this lever is fixed to a rod 2 which
extends across the front of the loom, at the other end of the rod
is a short arm 3 the turning of which places the spring piece 4
in a position to be struck by a stud 5 fixed to the shuttle
box front, when no change is required 4 is dropped down,
as in the sketch, 4 is connected and forms part of a bell.

134

crank lever 6.7 with its fulcrum at 8 the other end rests above the bottom cop 9 in the hopper, the above mentioned parts are fixed to the breast beam of the loom, 10 is the shuttle box and 11 the crank arm of the loom, when the weft fork acts and indicates that the weft is broken or finished the weft fork remains down and is pulled forward by the hammer lever 12 this pulling forward of the weft fork operates the lever 1 and turns rod 2 part way round and lifts up the short lever 3 so that when the key comes forward to beat up, the stud 5 fixed to the box front strikes 4 and operates the bell crank lever, 6.7 (the bottom cop in the hopper is at this moment directly over the cop in the shuttle) forcing the cop out of the hopper into the shuttle to take the place of the spent cop, the latter falling through the bottom of the box into a can standing at the side of the loom.

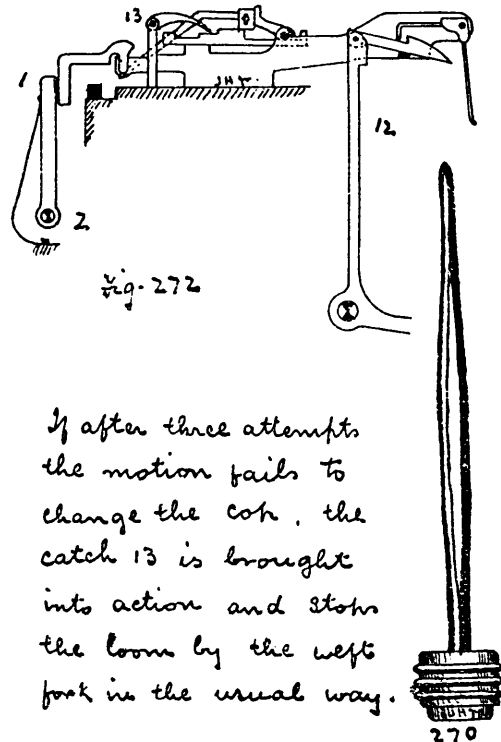
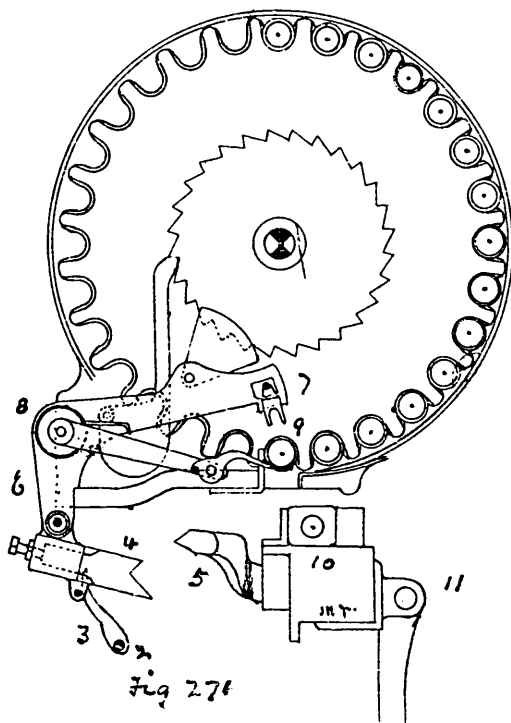

If after three attempts the motion fails to change the cop, the catch 13 is brought into action and stops the loom by the weft fork in the usual way.

270

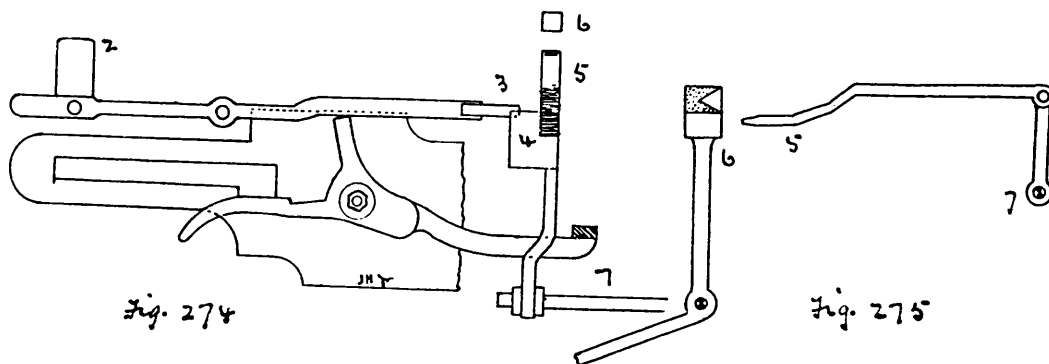
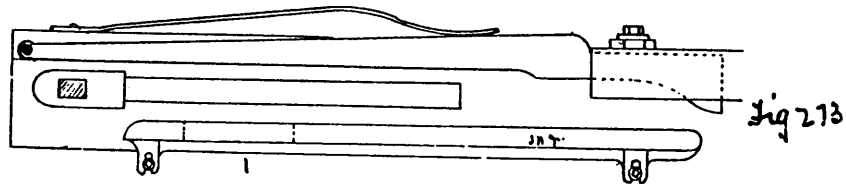

Feeler motion, when it is required that there shall be no broken picks in the cloth, then the automatic change by the weft fork is put out of action and the feeler motion Figs. 273, 274, 275 is employed which changes the weft when the cop is nearly spent. In the side of the shuttle box is a slot through which the feeler goes when the sley comes forward; if the cop is full then 2 is pushed back and no action takes place, if however the cop is spent the feeler remains as it is and the other end goes under a faller 4 on which is a tongue 5 and when the weft hammer is lifted a projection 6 catches the tongue pushing it back and turning the rod 7 which extends across the loom and forms part of the change mechanism. Fig. 275 shows a side view of the tongue and weft hammer, when 5 is held up it is caught by the shaded part, at other times it falls and passes underneath the shaded part.

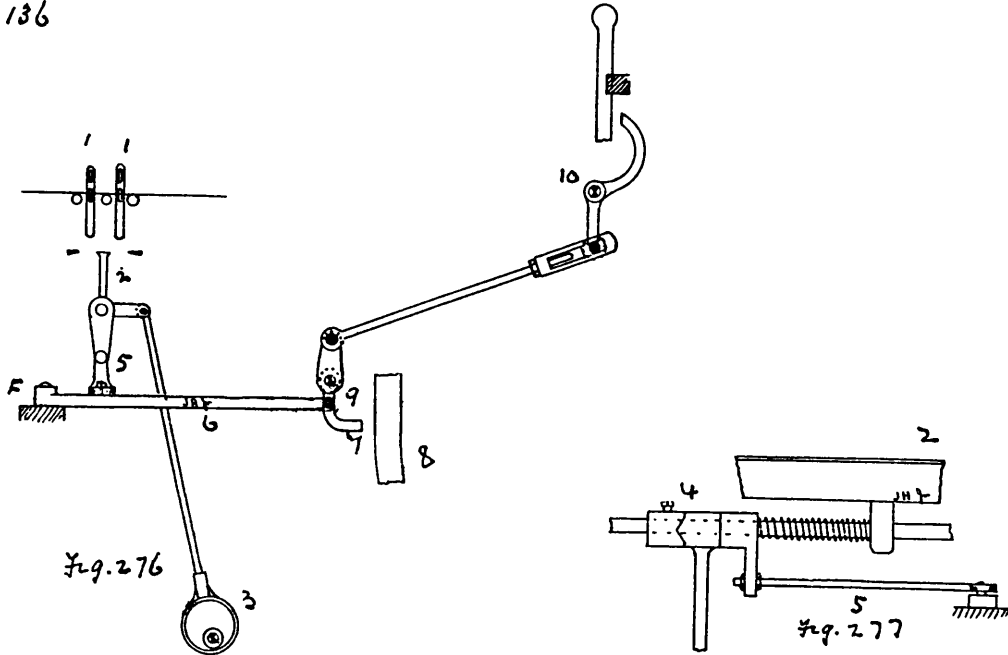

Warp Stop Motion. The object of this motion is to stop the loom when an end breaks. To accomplish this; each thread supports a light metal pin 1, underneath these pins is a vibrating toothed bar 2 which receives its motion from the eccentric 3, the effect of a thread breaking is to drop the pin between the bar and a fixed piece and stop the loom. Fig. 276 this action causes a break in the joint 4 Fig. and move the bar 5 forward turning 6 on the fulcrum F the effect of this is to move a stud 7 into the path of the sley sword 8 and this pushes the stud back and working on the fulcrum 9 and 10 knocks the starting handle out of position and stops the loom.

Positive Let-off Motion. Fig. 278 this arrangement depends upon the tension of the warp as it passes over the back rest, the pull of the warp depresses the back rest, thus moving the bell crank lever and spring rod 2. this movement is

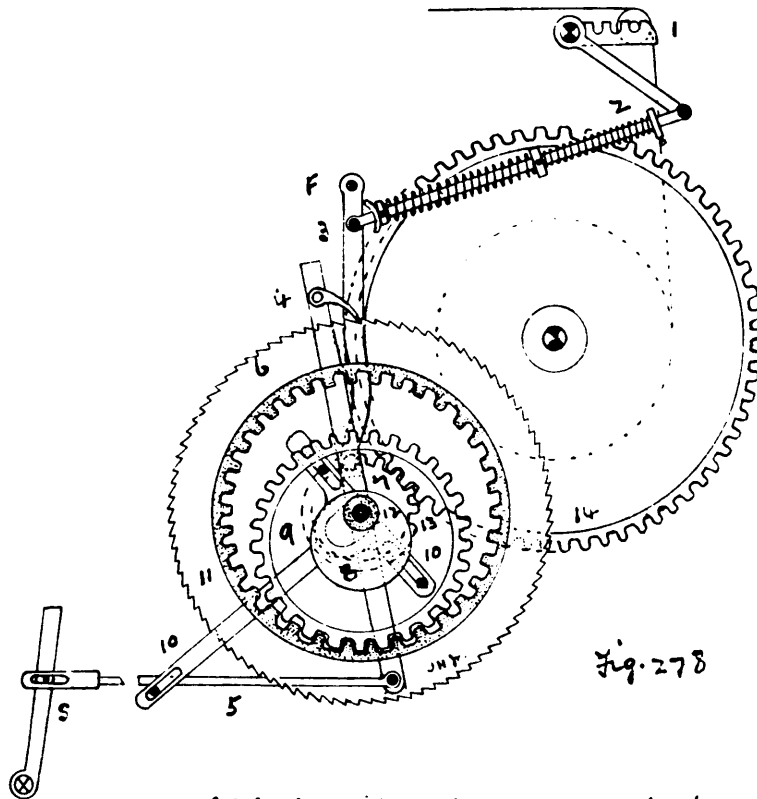

Fig. 278

given to lever 3 which has its fulcrum F at the top; the movement is then conveyed to the lever 4 which moves the haul P backward and with the connection at the other end moves the rod 5 so that the stud on the slay sword 5 pulls the rod forward and thus turns the wheel 6; this wheel however is not connected direct to the beam as the movement requires to be reduced, the wheel 6 is fast on the hollow shaft 7 (shaded) and this turns the cam 8, on this cam is a wheel 9 which is, by the action of the cam moved bodily round, but is prevented from turning on its axis by studs which are held by the bar 10, this movement of 9 moving round in the internal wheel 11 gives a rotary movement to 11 and as 11 is fast on the shaft 12 (black) on the other end of which is a small wheel 13 gearing with the wheel 14 which forms part of the flange of the weaver's beam.

138 Novelties and Special effects produced in fabrics.

From time to time cloths out of the ordinary run of weaves, or cloths which originally required to be made on Handlooms are made on power looms, especially is this the case in fancy lenos.

W. J. Riley invented and introduced the idea of having two cord ends, if desired of different colours passing through the same dent, either may be lifted as desired to produce fancy effects. He also introduced a special reed for making leno effects in imitation of hoppel weaving, the reed consists of a series of long and short dents Fig 279, the latter being bridged over by bent dents 1 the special warp threads for producing the hoppel effect are traversed by a sliding comb 2 actuated by a dobby or Jacquard, they are drawn down by doups to be woven in by the weft at one extremity of the lateral motion and are operated by the standard or other head at the other extremity of the motion.

Another fancy cloth is produced by using a reed made up of a series of inclined dents Fig. 280 by slowly raising and lowering the reed during weaving, wavy effects are produced by the warp threads in the cloth. W. J. Riley's patent for raising and lowering the reed is illustrated in Fig 281 by means of an eccentric or crank 1 and ratchet wheel 2 operated by a haul 3 fixed to the framing of the loom; or, the reed may be raised and lowered through a train of wheels and a crank or eccentric operated from the dobby as shown in Fig. 280 and as invented by R. Foulds.

For producing wavy effects west way W. J. Riley's patent Fig 282 consists of passing a series of warp ends over a bar 1 and another series of warp ends over another bar 2 the levers and to which the bars are fixed are operated by cams 3, 4 fixed to a shaft on the end of which is a ratchet wheel 5 operated from the dobby, the Jacquard or the take up motion of the loom.

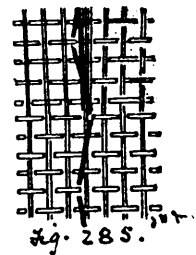
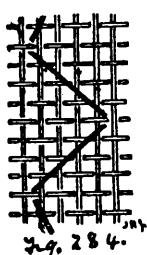
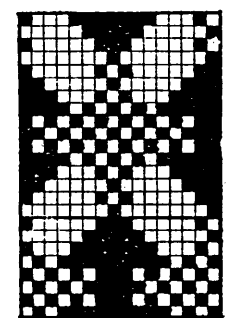
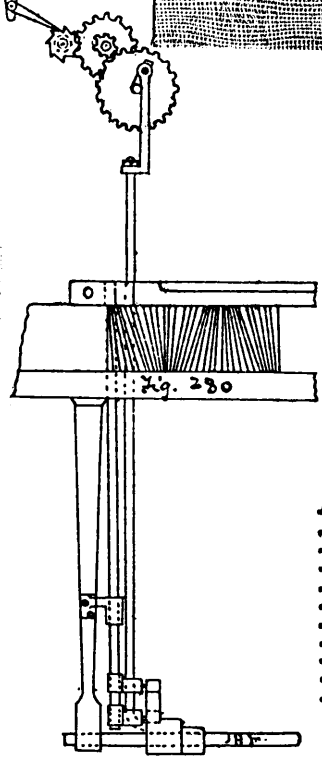
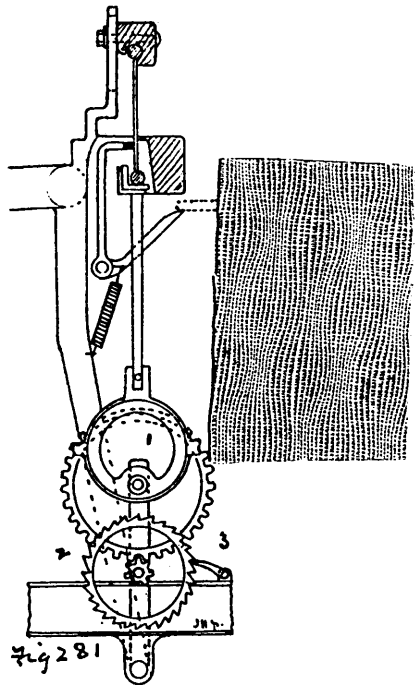
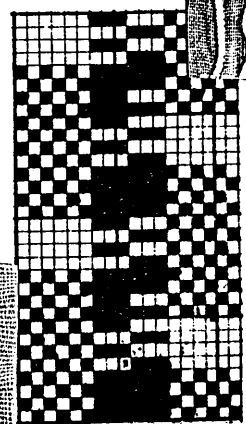
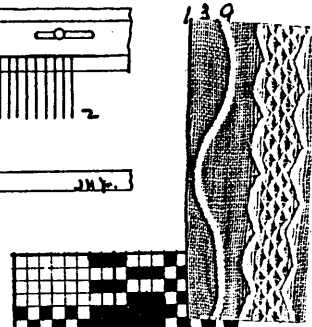
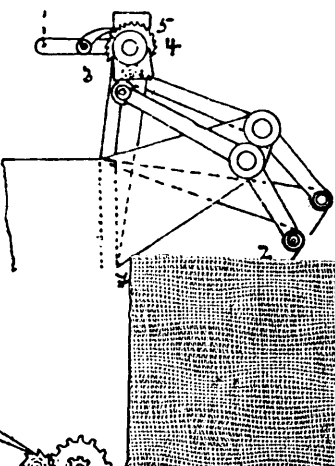
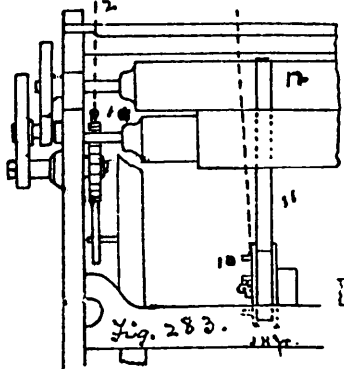
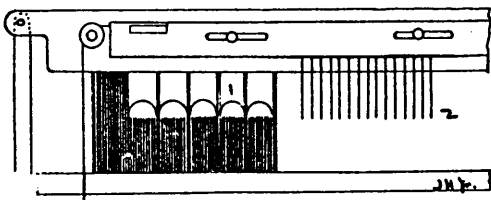
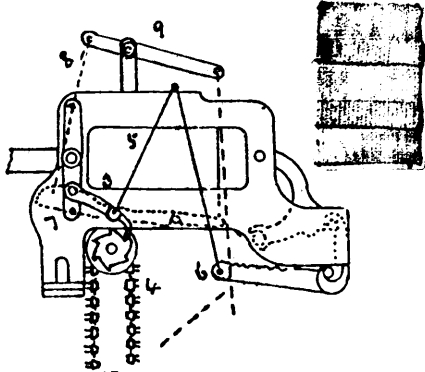

The weaving of tucks across the piece wft way is shown in the invention of S. H. Burrow and illustrated in Fig. 283. The tubular pleats or tucks across the piece are made by weaving at intervals with only part of the warp, the take-up catch 1 being put out of action by connection 2 from the dolly, the pushing haul 3 of the hatterm chain 4 for weaving pleats is put into action by a connection 5 from another jack 6, the feeler 7 of which is operated by a cord 8 and lever 9 from a peg wheel 10 driven by a band 11 from the take up roller 12 the catch 3 is lifted out of gear by a missing peg on one of the lags, allowing the jack 6 to fall in the usual way, the lag of the hatterm chain which is at the top when the catch 3 is raised is pegged to keep on shedding all the warps alternately so as to make plain cloth between the pleats.

Tucks or pleats warp way are shown in the invention of Desfandre & Bastien Fig. 284 weaving along with the ordinary warp ends 1 is a thick doup end, 2 at the end of each piece which must be of short length the thread 2 is drawn tight and the fabric becomes rucked or pleated as shown in Fig. 285. Another method is to cram a number of ends into one dent and allow them to weave plain cloth, in the same dent are one or two doup ends heavily weighted, at intervals these doup ends cross and draw the ends weaving plain cloth together forming pleats or tucks.

Imitation lens effects warp way are made by using a cord thread and by means of a close and open weave on each side of it to force the cord thread out of the straight line making a wave cord effect down the piece Fig. 286 gives an example. Fig. 287 gives an effective wave across the piece if thick cord wft is put in on picks 9, 10, and 19, 20.

JONES BROS BLACKBURN

Grooved Lags

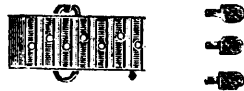

Plain Lags.



Slide Lags.



Selvage Healds and Harness.

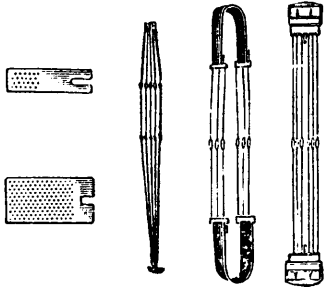

Slider Healds.

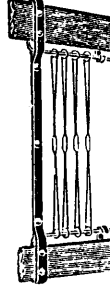

Plain Healds.

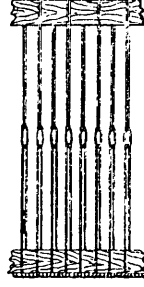

Mail Healds.

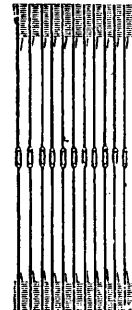

Wire Healds.

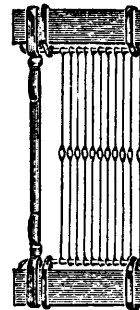

Twisted Healds for Canvas, etc.

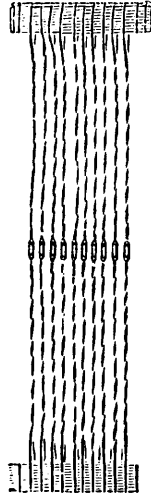

Reeds.

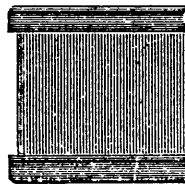

Combs.

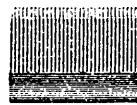

Perforated Strip.

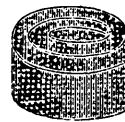

Shed Rods.

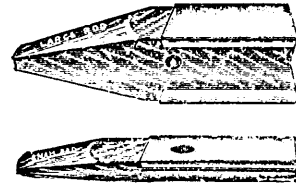

Split Chains.

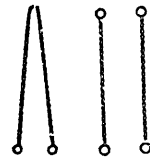

Split Cutter.

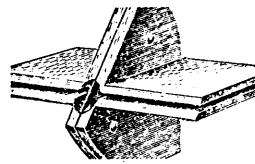

Steel Cards.

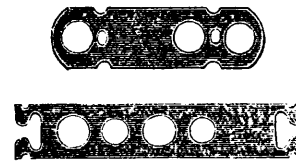

Established 40 years.

Gold Medallists.

Write for Catalogue.

WILSON BROS. BOBBIN CO. Ltd.

GARSTON, LIVERPOOL.

Telegrams : "Nugget, Liverpool."
Telephone No. : 90, Garston.

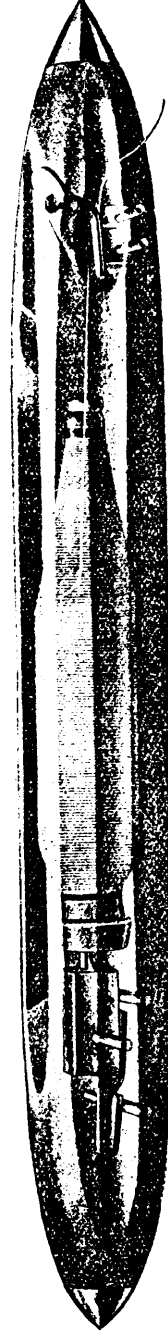

W.B. Patent Hand-threading Shuttle—"AMERIK."

BOBBINS and SHUTTLES.



W.B. Patent "COMPACT" No. 2.

Manchester Exchange :—Tuesdays and Fridays, No. 14 Pillar.
Manchester Office and Showroom :—19, Old Millgate.

WILSON BROS. BOBBIN CO.,
LIMITED,
GARSTON, LIVERPOOL.

BOBBINS & SHUTTLES.

GRAND PRIX,
BRUSSELS, 1910.



GRAND PRIX,
JAPAN-BRITISH,
1910.



GRAND PRIX,
IMPERIAL
EXHIBITION,
LONDON, 1911.

SHUTTLES

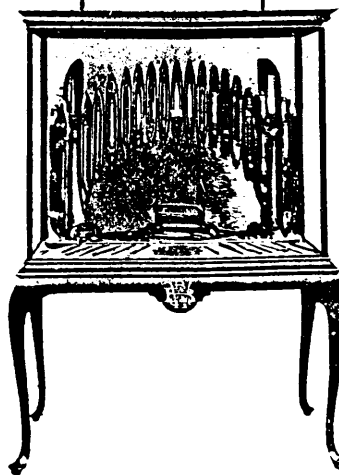

GRAND PRIX,
ROUBAIX, 1911.



GRAND PRIX,
TURIN, 1911.
(Bobbins & Shuttles).



GRAND PRIX,
TURIN, 1911.
(Chemicals).

67 Highest Awards and Diplomas 67

(Including 6 Grands Prix).

Telephone : 90, Garston.

Telegrams : "Nugget," Liverpool.

TELEGRAMS: "GLOBE, ACCRINGTON."

TELEPHONE NO. 8. (4 LINES.)

MANCHESTER ROOMS: 61, DEANSGATE ARCADE (TUESDAY AND FRIDAY).

HOWARD & BULLOUGH, Ltd.,

ACCRINGTON,

MAKERS OF

Opening Scutching, Carding, Combing,
Preparing, Spinning & Doubling Machinery

FOR

COTTON.

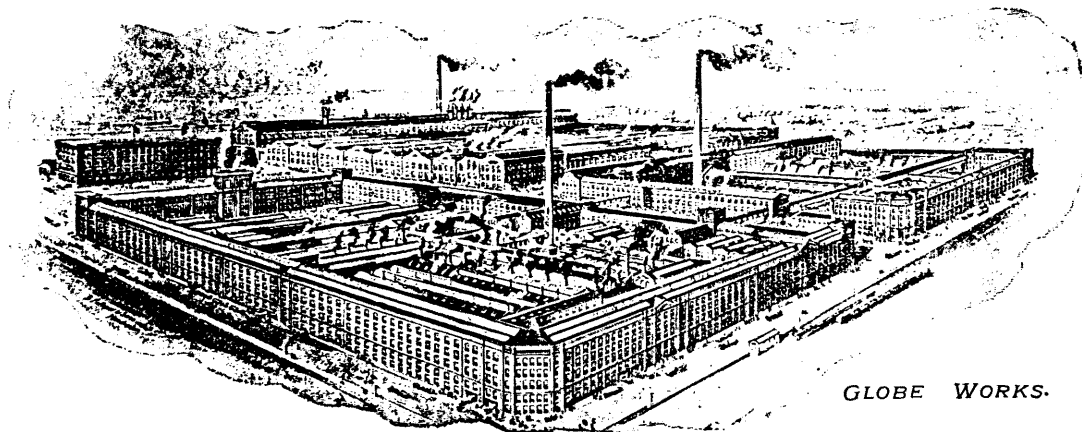

GLOBE WORKS.

ALSO OF

Winding, Beaming & Sizing Machines,

WITH LATEST IMPROVEMENTS.

All Communications to be addressed to the Firm.

Telegraphic Address
TRAGASOL, LITTLE SUTTON
MANCHESTER ROYAL EXCHANGE. ■
TUESDAYS and FRIDAYS.

Telephone N^o 27,
HOOTON EXCHANGE.



The **SIZE** used on your Yarn, controls
the **SIZE** of your Loom production,
the **SIZE** of your Cloth Sales, and ultimately
the **SIZE** of your profits.

ONE-FIFTH of the World's Power-Looms are running with WARPS SIZED
by the help of

GUM TRAGASOL

The remainder are coming along.

HIGHEST RESULTS : More Elasticity! More Strength!
Less Dust! Greater Production! Superior Cloth.

Also for Calico-Printers, Dyers, Finishers, Bleachers, Lace Dressers,
etc.

TRY IT! Write for Samples and Particulars to—

The Gum Tragasol Supply Co., Ltd.,
HOOTON, by Chester.

Telegraphic Address
for Holland:

"Tattersall, Enschede."

Telegraphic Address
for Germany:

"Tattersall, Gronau, I/W."

Telegraphic Address
for England:

"Holdsworth. Burnley."

TATTERSALL & HOLDSWORTH'S

GLOBE WORKS & STORES,

Enschede & Rotterdam, Holland; Burnley, England;
and Gronau, i/Westphalia.

MAKERS of all kinds of
MACHINERY

USED IN
SIZING, DYEING, WASHING,
FINISHING & DRYING.

Also Makers of all kinds of
TIN, COPPER, & BRASS
GOODS used in the
Textile Trades including
STEAM & WATER
FITTINGS, TAPS,
VALVES, PUMPS,
FANS, &c., &c.

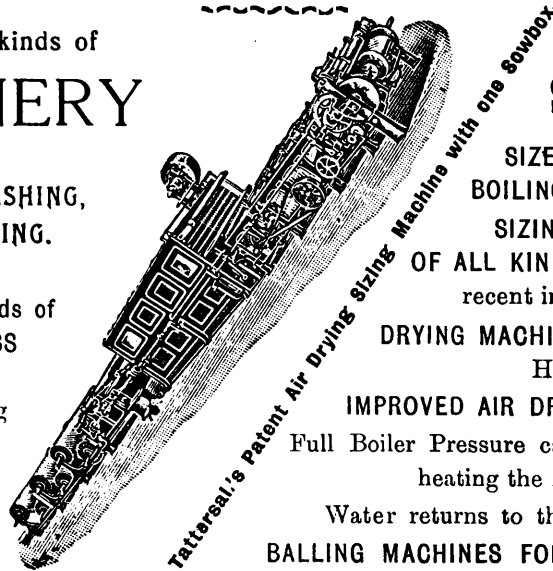

SPECIALITIES :

SIZE MIXING AND
BOILING APPARATUS.

SIZING MACHINES
OF ALL KINDS, with the most
recent improvements.

DRYING MACHINES, Vertical and
Horizontal

IMPROVED AIR DRYING MACHINES
Full Boiler Pressure can be used for
heating the Air.

Water returns to the boiler easily.

BALLING MACHINES FOR SIZED WARPS.

All kinds of VALVES, TAPS, & GUN METAL FITTINGS.

All kinds of PUMPS FOR SIZE & WATER.

CENTRIFUGAL PUMPS FOR WATER, ACID, OIL, &c. SPECIAL OIL PUMPS.

COPPER & TIN DRYING CYLINDERS.

TIN, COPPER, & BRASS GOODS used in Cotton, Woollen, Flax and Jute Mills,
and Print and Dye Works.

SELF-LANDING CRANES.

PLANS & ESTIMATES submitted for the complete Equipment of Mills & Works.

C. COOPER & SONS, Ltd.

MACHINISTS,

Seed Street Ironworks,

Late Thomas Street Works, **RADCLIFFE.**

TELEPHONE No. 3.

NEAR MANCHESTER.

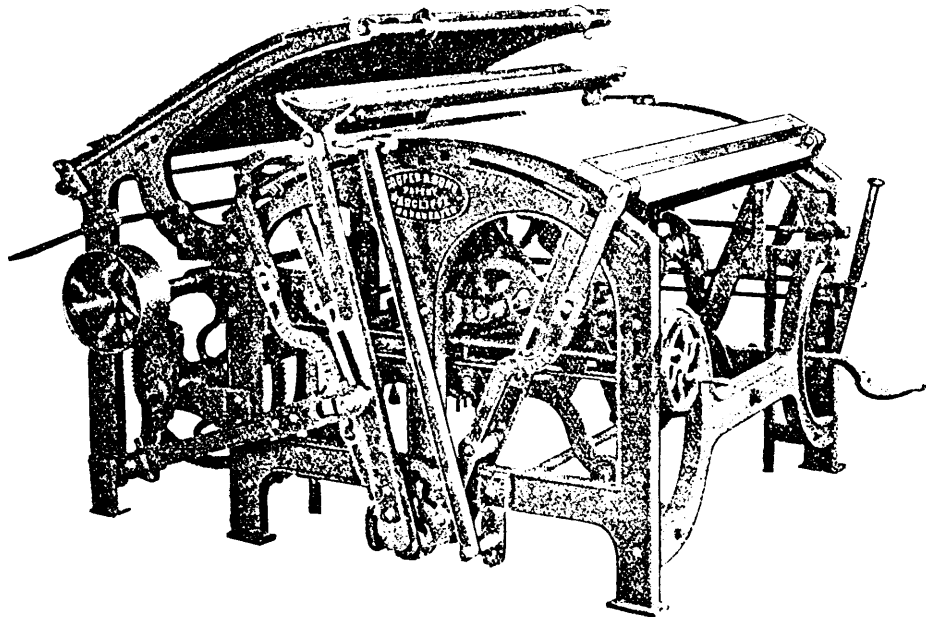

PATENT FOLDING AND MEASURING MACHINE,

With Coopers' Patent Silent Positive Swivel Grip (No Springs) Balance, Table and Regulating Motion .

PLEASE NOTE.—That all bearings are bushed, all motions positive, and that the machine can be run at a quicker rate, with less power to drive with either electricity, hand, or any other power.

Warranted to fold any kind of Woven and Finished Fabrics without damage or marks.

**PATENT REGULATING MOTIONS FOR LONG OR SHORT PLAITS.
THE SIMPLEST AND BEST MACHINE IN THE TRADE.**

Special kinds of Cards or Rubber Grip Rails for any kind of finished fabrics.

The Patent Grip and Table Motions can be attached to other Machines at a small cost.

ALSO MAKERS OF

C. COOPER & SONS' Patent Lapping, Rolling and Measuring Machine, with Coopers' Patent Expanding Swords, Spring Catch and Measuring Motion.

THOMAS HOLT, Limited, ROCHDALE.

SOLE MAKERS FOR GREAT BRITAIN.

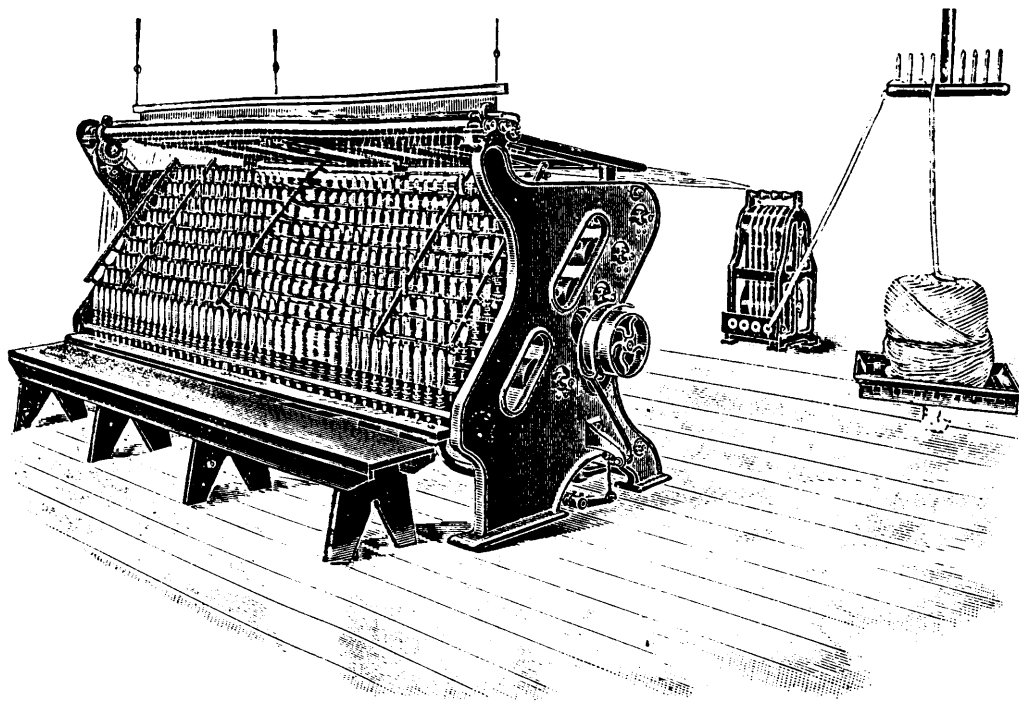

TO MAKE GOODS LOOK BRIGHTER & BETTER, USE THE

THE WARP PINNING MACHINE

FOR WINDING YARN FROM THE BALL, WARP, BEAM OR CHEESE,
ON TO PAPER OR WOOD PIRNS.

Cost of Production reduced **70%**.

REVOLUTION IN DYEING.

BEAM DYEING

(Brandwood's Patents, protected by numerous patents in all
Industrial Countries.)

Dyeing at one operation One to Twelve Beams
all the fastest known colours, including Indigo, Hydron, Indanthrene,
and other Oxidation colours. This system is destined to revolutionise
yarn dyeing by enabling coloured manufacturers to dye and size their
own yarn on the beam, thus dispensing with warp and chain dyeing and
dressing, and all its attendant evils.

The great advantages of this system of Beam Dyeing are :—

- (1) The most economical way of dyeing in existence. The full set
of beams required are dyed at one operation, thus ensuring one
uniform shade at the minimum cost. The dyehouse labour
cost is reduced to a very low figure, together with some saving
in dyeing materials and floor space.
- (2) The beaming and dressing costs are saved altogether.
- (3) An average of 10% greater production from the loom because
all the elasticity and stretch is preserved in the yarn.

The dyeing is guaranteed even and level, and suitable for solid cloths
of all descriptions, and Plants are already at work and on order capable
of dyeing one million pounds weight of yarn weekly.

Beam Dyeing is of no service to the small manufacturer, or where
the weights to a shade are small and varied.

For full particulars and estimates, apply—

The ELTON COP DYEING Co. Ltd.,
BURY

WAKE UP !

DYEING & BLEACHING YARNS
ON BACK BEAM.

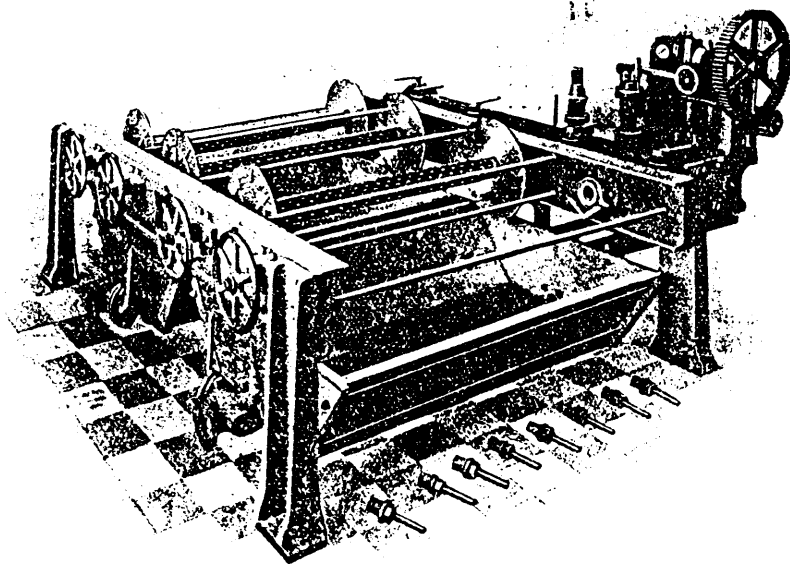

Now working in the Large Mills of England, India,
Russia, Spain, and the Phillipines, &c.

WRITE FOR SPECIAL PAMPHLET TO SOLE MAKERS & PATENTEES—

Baldwin & Heap L^{td.},

Tel. 154. **BURNLEY, ENGLAND.**

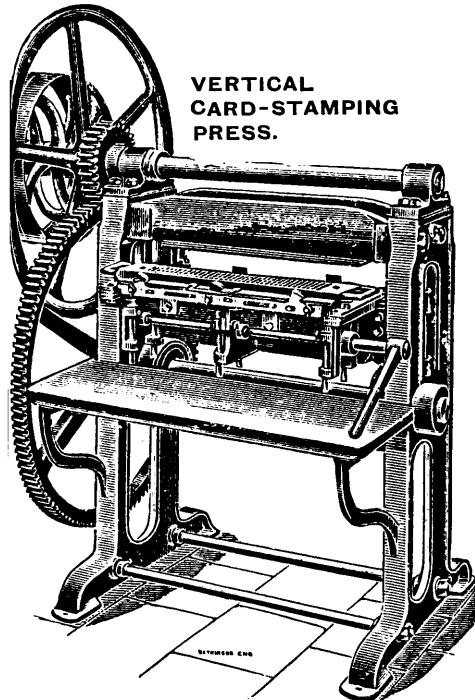

**VERTICAL
CARD-STAMPING
PRESS.**

Robt. Fielding & Son,

TELEPHONE
5600 CITY.

Sycamore Street,
MANCHESTER.

Designers & Card Cutters,

for all kinds of JACQUARD WORK, in Silk,
Cotton, Woollen, Linen, etc., for

| | | | |
|-------------|------------------|---------------|--------------|
| Damasks | Lenos | Table Covers | Quilts |
| Brocades | Poplins | Handkerchiefs | Counterpanes |
| Zephyrs | Dhooties | Shawls | Tapestries |
| Dress Goods | Terry Clothes | Rugs | Carpets |
| Velvets | Napkins | Blankets | Furnitures |
| | Coat Labels, &c. | | |

Laced Blank Cards ready for repeating. Cards cut from
Manufacturers' and Students' designs.

SKETCHES in LATEST STYLES from Stock or to Order.

REPEATING EXECUTED PROMPTLY, by two of
DEVOGE'S SELF-ACTING REPEATERS.

DESIGNS & CARDS sent Laced and Wired ready
for Weaving.

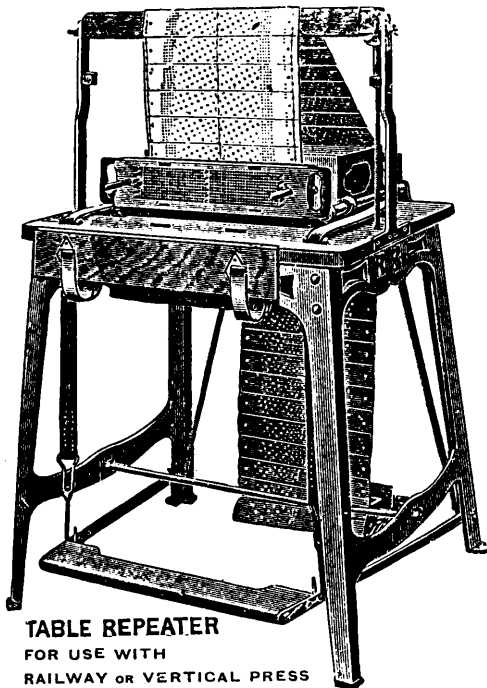
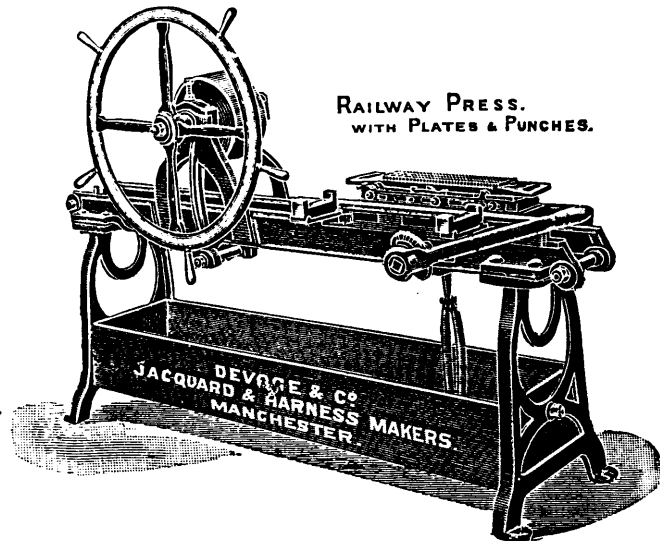

TABLE REPEATER
FOR USE WITH
RAILWAY OR VERTICAL PRESS



RAILWAY PRESS.
WITH PLATES & PUNCHES.

The OLDEST JACQUARD MACHINISTS in the WORLD.

DEVOGE & CO., Ash and Sycamore Streets, MANCHESTER.

TELEPHONE :
5600 CITY.

MAKERS OF

High-class Jacquard Machines, Harnesses,
Card Cutting Machinery,

And all Accessories and Appliances for Fancy Weaving.

Single-Lift Jacquards
Double-Lift Jacquards
Double-Cylinder Jacquards
Patent Leno-Jacquards
Rise and Fall Jacquards
Cross-Border Jacquards
Carpet Jacquards

Glass, Brass, and Steel Mails
Comberboard Slips
Solid Comberboards
Dhooty Comberboards
Hooks, Needles, and Springs
Wire Linges, Plain
Plated or Japanned

Handloom Jacquards for all kinds of Experimental Jacquards.
Special D.ep-Lift Jacquards for Heavy Goods.

PIANO CARD CUTTING MACHINE

TO CUT CARDS FROM DESIGN.

SELF-ACTING REPEATER to cut 40 cards per minute.

Hand Repeater with Vertical or Railway Press.

CARD NIPPERS for odd holes.

NEW PATENT SECURE GRIP CYLINDER LANTERN.

HARNESS BUILDING A SPECIALITY.

JACQUARD CARDS IN ALL SIZES.

SPECIAL WAXED THREADS FOR CARD WIRES.

Patent Loops and Links for working Double-Lift Jacquards with Single Cords.

Harness Hooks and Cords for Detaching Harness.

SPECIAL QUALITY HARNESS VARNISH.

VARNISHED HARNESS THREAD FOR REPAIRS, etc.

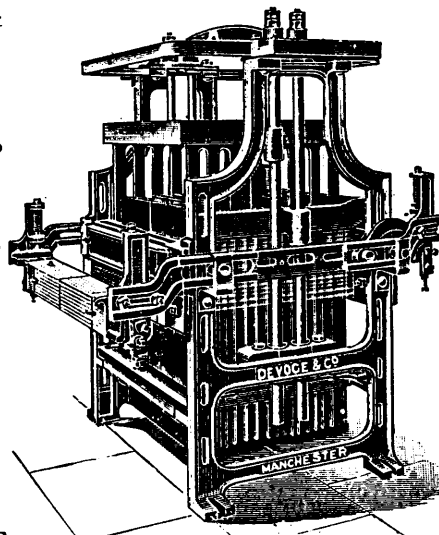

DOUBLE-LIFT
DOUBLE-CYLINDER JACQUARD.
SLIDE MOTION.

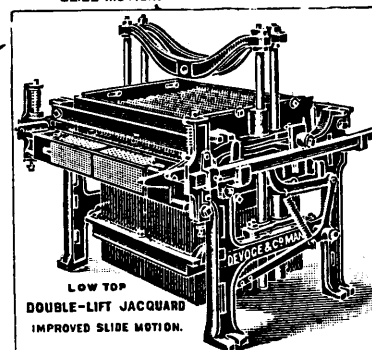

LOW TOP
DOUBLE-LIFT JACQUARD
IMPROVED SLIDE MOTION.

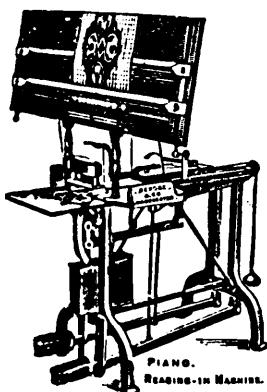

PIANO
READING-IN MACHINE.

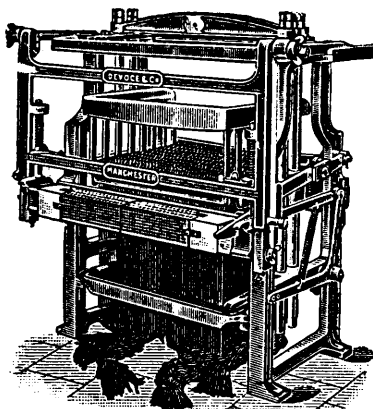

DOUBLE-LIFT MACHINE SWING MOTION.

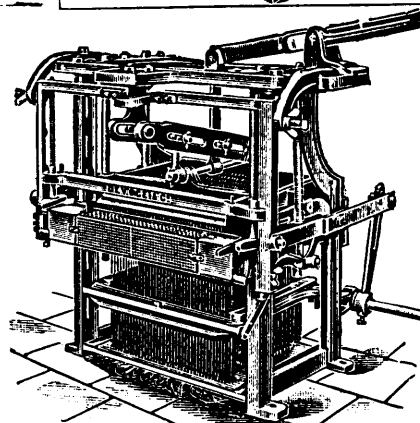

PATENT LENO-JACQUARD.

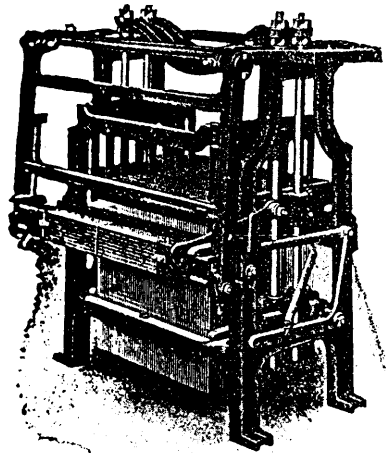

Double-Lift Jacquard,
Single Cylinder (Swing Motion)

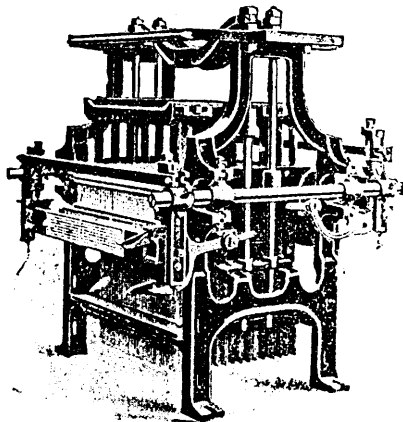

PATENT IMPROVED
DOUBLE-LIFT DOUBLE-CYLINDER JACQUARD
SWIVEL SLIDE MOTION

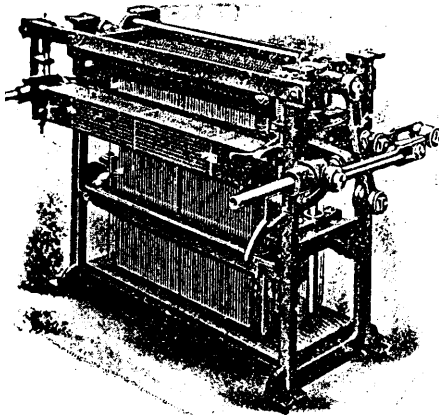

Single-Lift Jacquard Machine,
for Hand or Power Loom.

THE OLDEST JACQUARD MACHINISTS IN THE WORLD.

DEVOGE & CO.,

Ash & Sycamore Streets,
MANCHESTER.

TELEPHONE: 5600 CITY.

JACQUARD MACHINES, HARNESSES, PIANO CARD CUTTING MACHINES,

Automatic and Hand Repeaters.

Specially constructed Machines for Terry, Carpets,
Smallwares, Ribbons, etc

REDUCED PITCH JACQUARDS FOR LARGE DESIGNS.

Jacquard Machines, Harnesses, Healds,
Designs and Cards specially arranged for use
in Technical Schools, and for Experimental Purposes.

Special 100^S Jacquards for Dhooties, Names, etc.

| | | |
|-----------------------------|--------------------------|----------------|
| Hooks, Needles, Springs | Comberboards | Harness Thread |
| Glass, Brass, & Steel Mails | Dhooty Side-border Slips | Waxed Thread |
| Lingoes | Special Harness Varnish | Card Wires |

All Sundries for Dobby and Jacquard Repairs,
and every Requisite and Appliance for Fancy Weaving.

TELEPHONE: 5600 CITY.

R. FIELDING & SON,

Sycamore St., MANCHESTER.

Designers & Card Cutters.

LATEST STYLES FOR

| | | | |
|-----------------------------------|----------|----------------|-------------|
| DAMASKS, | POPLINS, | TABLE-COVERS, | QUILTS, |
| BROCADES, | LENOS, | HANDKERCHIEFS, | TAPESTRIES, |
| DRESS GOODS, | VELVETS, | RUGS, | CARPETS, |
| FURNITURES, SMALLWARES ETC., ETC. | | | |

Cards cut and laced from Manufacturers' and
Students' own designs.

REPEATING PROMPTLY EXECUTED. LACED BLANK CARDS.

GEORGE KEIGHLEY

Limited,

BURNLEY.

Telephone No. 172.

Telegraphic Address: "Keighley, Burnley."

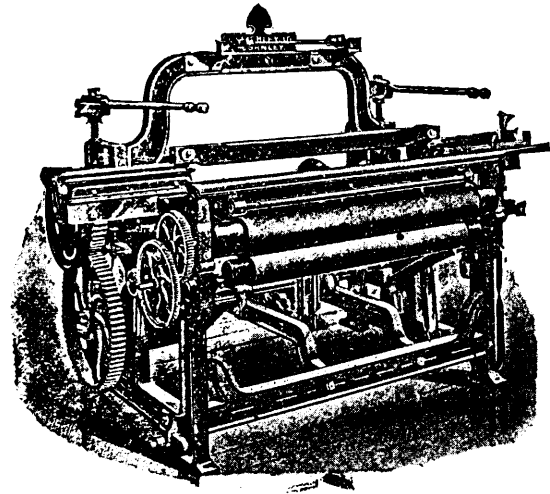

MAKERS
OF
LOOMS

FOR
LIGHT, MEDIUM,
and HEAVY
CALICOES.

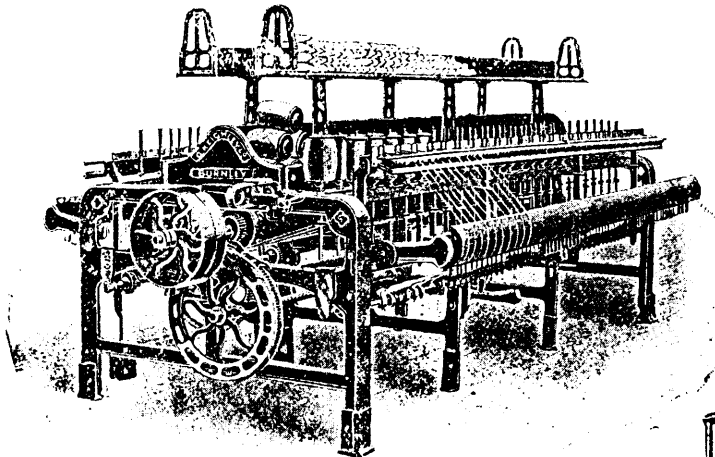

WINDING MACHINES.

WARPING MACHINES.

Slasher Sizing Machines.

Size Mixing Apparatus.

Cloth Folding Machines.

Hydraulic Piece Presses.

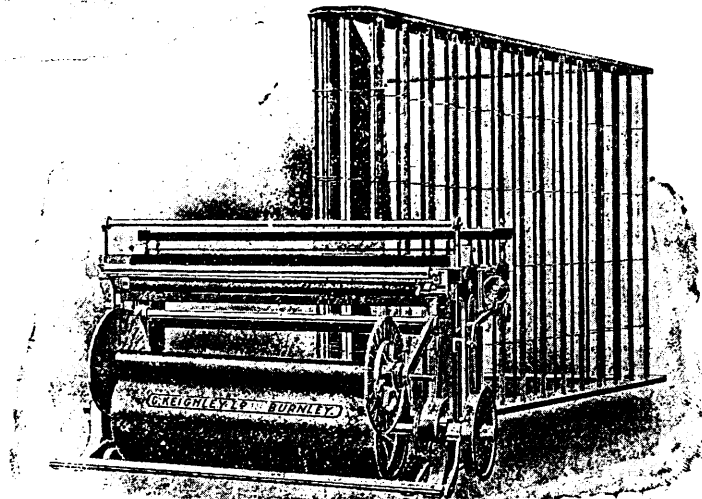

PEMBERTON & CO.,

Loom Makers,

BURNLEY.

HIGH-
SPEED
LOOMS

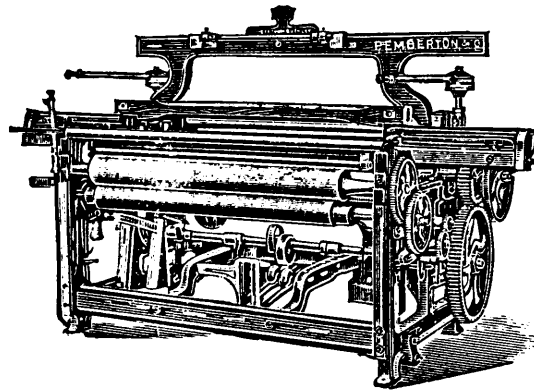

UP-TO-DATE
LATEST
MODELS.

Preparation Machinery.

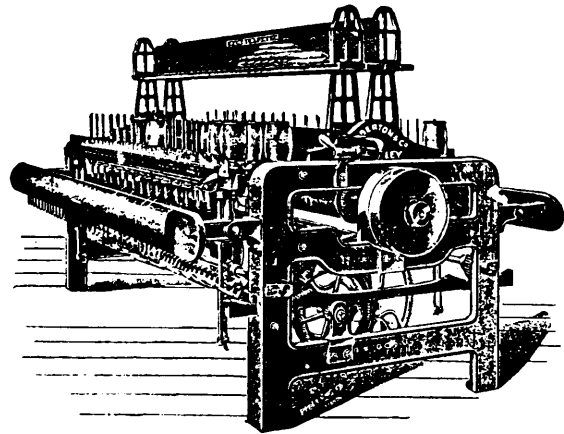
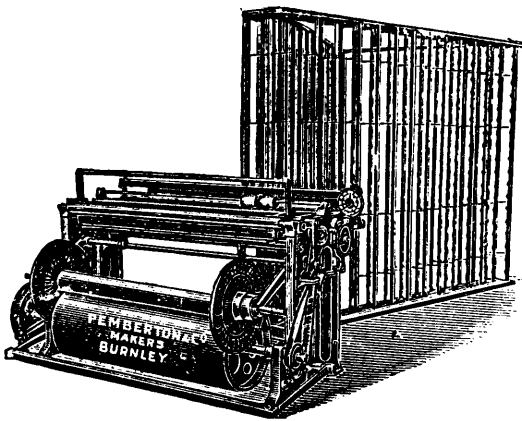

W. B. WHITE & SONS, Ltd.,

LOOM MAKERS, TEXTILE MACHINISTS, COLNE.

White's Patented and Registered "Dreadnought" Dobby.

All parts adjustable, with large round bearings, the full width of the jacks; no teeth or rider or knuckle joints or streamers to the jacks. The JACK LEVERS ARE BALANCED like a WEIGH BAULK and NEED NO LIFTING. This new See-Saw counterpoise movement makes the Dobby the sweetest, easiest and most durable working Dobby on the market; and it also requires less power to drive same. **PLEASE TRY ONE.**

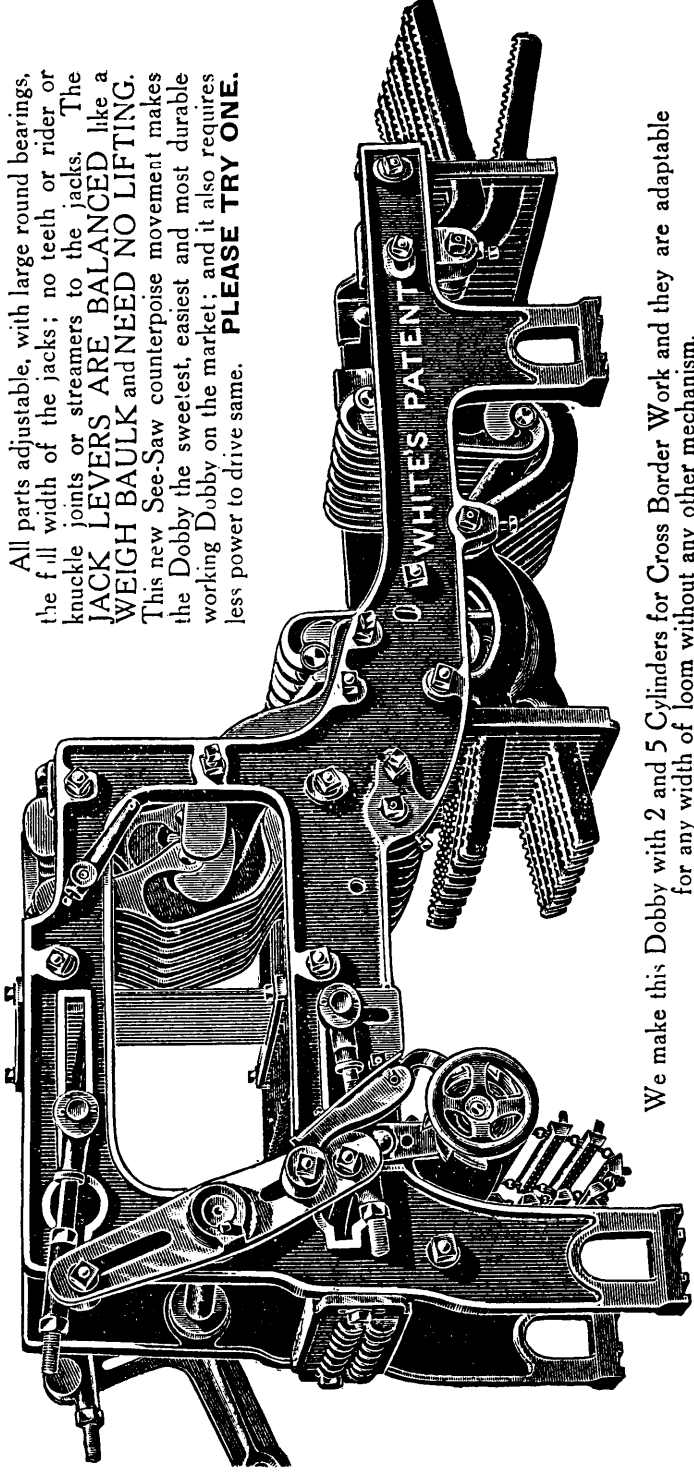

We make this Dobby with 2 and 5 Cylinders for Cross Border Work and they are adaptable for any width of loom without any other mechanism.

Royal Exchange: Tuesday and Friday, P Pillar, 2 to 3. Telephone, 436. Telegrams: "Hacking, Bury."

HACKING & Co., Ltd., BURY,

— FOR —

Up-to-Date Winding, Warping & Sizing Machines.

LOOMS OF ALL DESCRIPTIONS.

CLOTH FOLDING MACHINE, CONCAVE & OVAL TABLES.

HYDRAULIC & GEARED CLOTH PRESSES. CLOTH INSPECTING MACHINES.

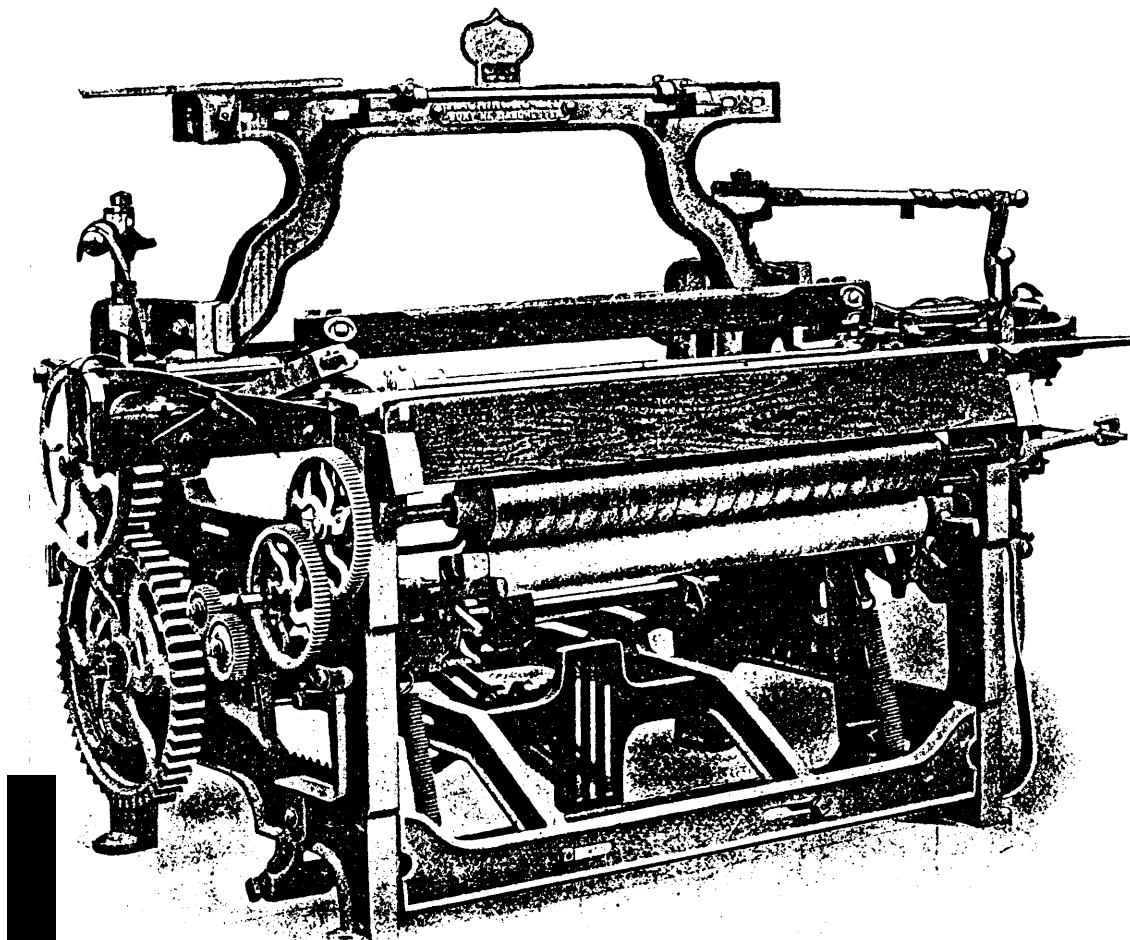

FAST RUNNING CALICO LOOM.

FAIRBURN'S

ESTABLISHED 1864.

IMPROVED PATENT

TELEPHONE 754.

SPLIT MOTION

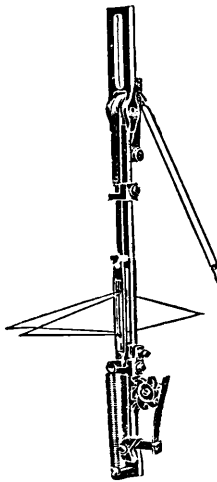

THIS MACHINE IS NOW VERY LARGELY USED
IN ENGLAND AND ON THE CONTINENT.

THE WORKING PARTS HAVE BEEN GREATLY STRENGTHENED
AND IMPROVED IN THE LATEST PATENT.

The object of this Invention is to effect the tying-in of the Warp and Weft Threads, so as to make an imitation selvage, that will not readily give way, nor allow the cloth to fray at the edges when cut.

This apparatus, so compact in itself, and combining great simplicity of parts with general neatness, has the advantage of being easily adapted and worked on any kind of Loom, from a plain to a jacquard.

This machine allows the weft to be beaten up into the cloth before the lock-stitch takes place. There is therefore no friction on either "split ends" or weft, allowing a lower quality of yarn to be woven with better results than with other methods of weaving splits. Makes an even split all through the piece. SAMPLES SENT ON APPROVAL.

Machine-Cut GIB KEYS

for Shell Bosses of Looms made in all Sizes.

These are stocked in sizes varying only $\frac{1}{32}$ inch in thickness between one size and the next, which is a great benefit to Tacklers, no filing or fitting being required. By adopting the use of these Keys Manufacturers will save pounds each year.

MAKER OF HIGH-GRADE SPIRAL SPRINGS, TEMPLES, AND TEMPLE ROLLERS FOR ANY
KIND OF CLOTH. TEMPLE BRACKETS OF ALL DESCRIPTIONS ALWAYS IN STOCK.

SHUTTLE GUARD MAKER.

SHELL BOSSES & SPLIT SHELLS, &c., in Malleable Iron for all makes of Looms.

QUEEN STREET MILL, MEADOWS, BURNLEY.

Manchester Royal Exchange :
Tuesdays & Fridays,
2 to 3 p.m.
No. 12 Pillar.

GEO. KEIGHLEY

Limited,
BURNLEY,

MAKERS of all
classes of

LOOMS

TELEGRAPHIC
ADDRESS:
"Keighley,
Burnley."

TELEPHONE N
172.

Also
DOBBIES,
WINDING
MACHINES,
WARPING
MACHINES,
SLASHER
SIZING MACHINES,
SIZE MIXING APPARATUS,
CLOTH FOLDING MACHINES,
HYDRAULIC PIECE PRESSES,
SECTION WARPING MACHINES,
DRUM & PIRN WINDING MACHINES.

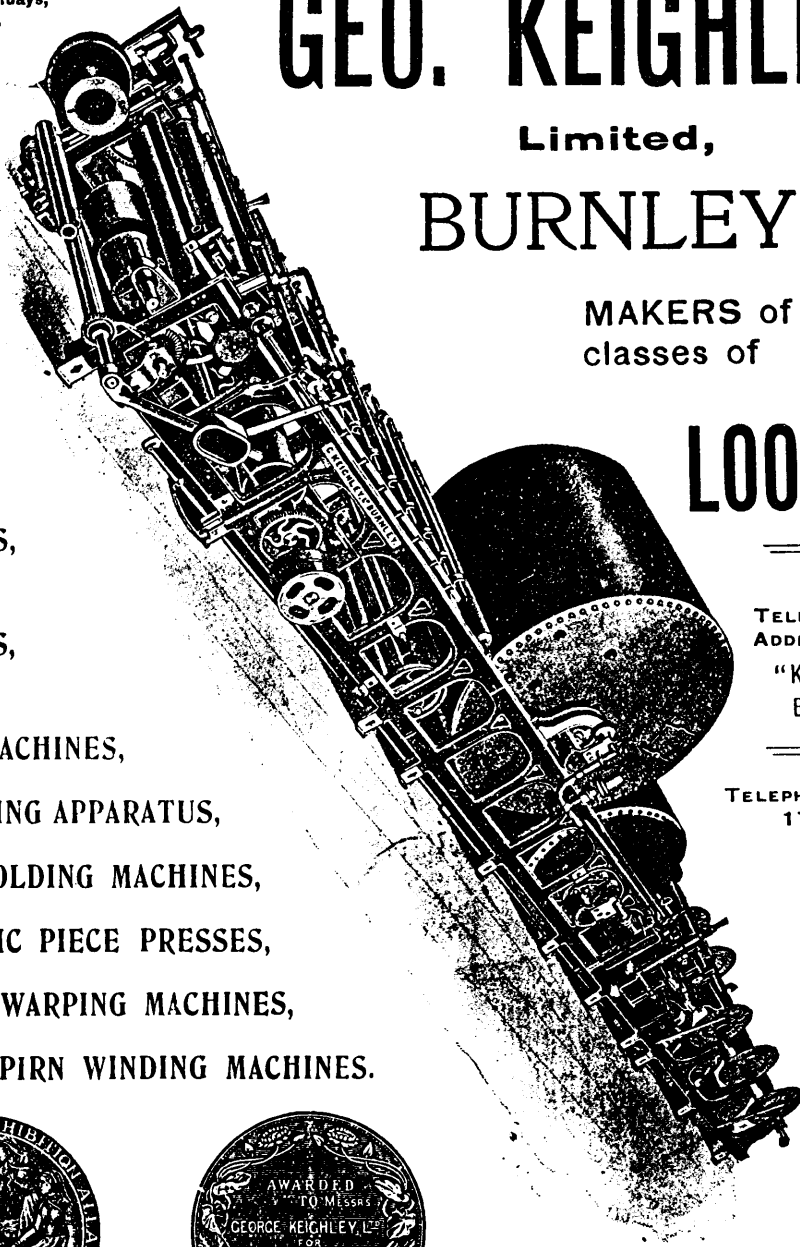

PLATT BROTHERS & Co.

LIMITED,

Hartford Works, OLDHAM, ENGLAND,

ESTABLISHED 1821.

Makers of all kinds of MACHINERY

FOR

GINNING COTTON, OPENING, CARDING, COMBING,
PREPARING, SPINNING, DOUBLING AND REELING,
COTTON, WOOL, WORSTED, WASTE, ASBESTOS, &c.

ALSO

Makers of PREPARING MACHINERY for

WEAVING,

including Winding, Warping, Sizing, Beaming and Dressing,
Machines for Cotton, Linen and Jute Yarns.

Makers of POWER LOOMS

FOR ALL DESCRIPTIONS OF

**PLAIN and FANCY CLOTHS in Cotton, Linen, Woollen,
Worsted and Jute.**

ALSO

Jacquards, Dobbies, Oscillating Tappets, Wood-
crofts' Section Tappets, and Shedding Motions
of every description.

HIGHEST AWARDS AT INTERNATIONAL AND OTHER
EXHIBITIONS FOR TEXTILE MACHINERY.

Telephone No. 26.

Telegrams : "PLATTS, OLDHAM."

John Pilling & Sons, Ltd.,

LOOM MAKERS,

Primet Foundry, COLNE, Lancs.

MANCHESTER EXCHANGE:

No. 12 PILLAR,

Tuesdays and Fridays, 1.30 to 2.30 p.m.

Telegraphic Address: "Pillingsons, Colne."

Nat. Telephone No. 43.

LOOMS

for Weaving Light, Medium,
and Heavy Plain or Fancy
Cotton, Silk, Linen or
Checked Goods.

FULL PARTICULARS
with
PRICES & DRAWINGS
on application.

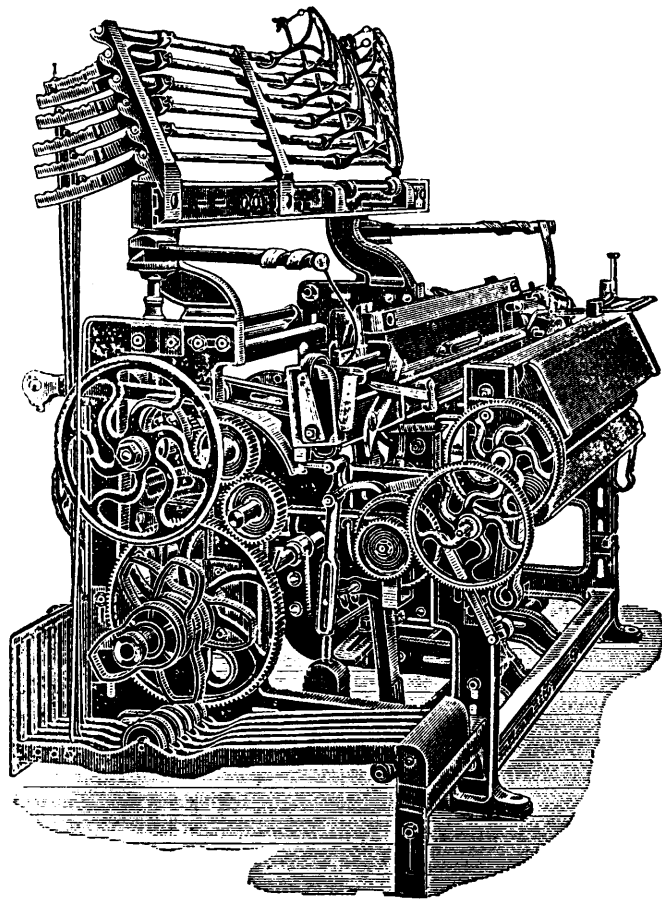

ALSO MAKERS OF

SCOTCH BEAMING MACHINES, DRESSING
FRAMES, HANDKERCHIEF MOTIONS, &c.

BUTTERWORTH & DICKINSON,

LIMITED,
BURNLEY, England.

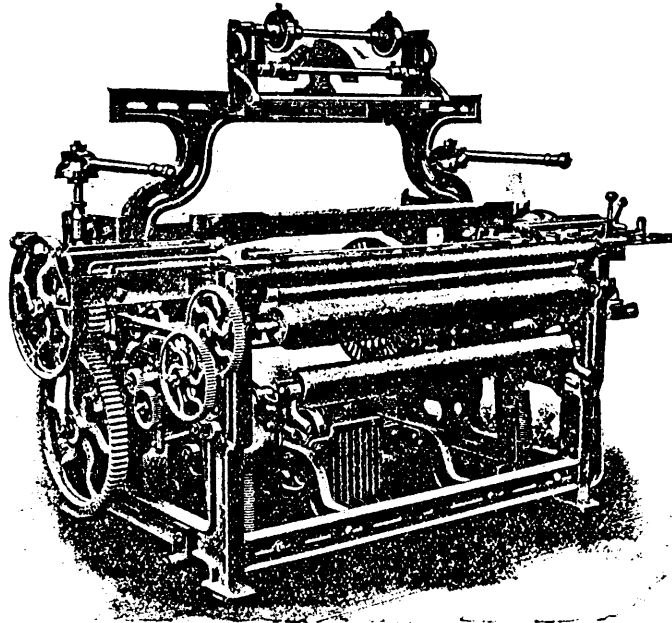

Model No. 5. Strong Calico Loom with inside Treading Motion for 3 and 4 Shafts, with Heald Levelling Arrangement.

Makers of **LOOMS** of all descriptions,

For Weaving Cotton, Linen, Silk, and Worsted Goods,

For 1, 2, 3, 4 or 6 Shuttles, from 24 in., to 160 in. reed-space.

ALSO ALL KINDS OF PREPARATION MACHINERY FOR WEAVING:—Winding, Warping, and Sizing Machines, Beaming and Warp Dressing Machines, Plaiting Machines, Hydraulic Cloth Presses, Dobbies and Accessories.

Cast Steel Flanges for Warpers' and Loom Beams of all sizes.

Specialities:—

Improved Scotch Beaming Frames & Dry Sizing (Winding-on) Machines for Coloured Work. Patent Beam-lowering Arrangement for Warping Machines. Patent Zig-zag Wraithes for Warping and Sizing Machines. Patent Shawl-marking Motion and Patent Circulating Sow Box for Sizing Machines. Slasher Sizing Machines with improved Ball Bearings for Cylinder Shafts. Slasher Sizing Machines with Positive Drive for Cylinders. Looms arranged for Individual Drive from Electric Motors, and fitted with Patent Actuating Gear for Controlling Switch. Terry's Patent "Durable" Dobbies.

Telephone 141.

Cooper Bros. LTD.

BETHESDA STREET
FOUNDRY

BURNLEY

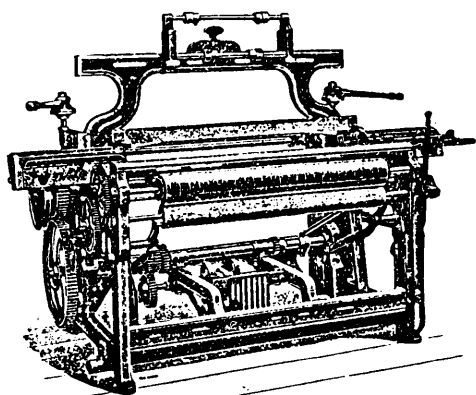
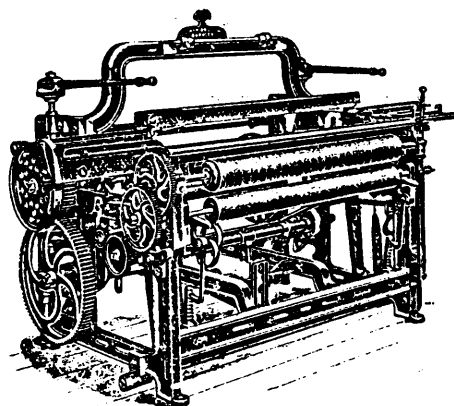

LOOMS

ARE

OUR SPECIALITY

for Weaving Light, Medium
or Heavy Cloths.

Inside Treading Rollers, or
Spring Tops.

Outside Treading Motions with Cross Rods

HIGH SPEED with
efficiency are the
leading features of
our Looms,

and these facts are so acknowledged
by all users.

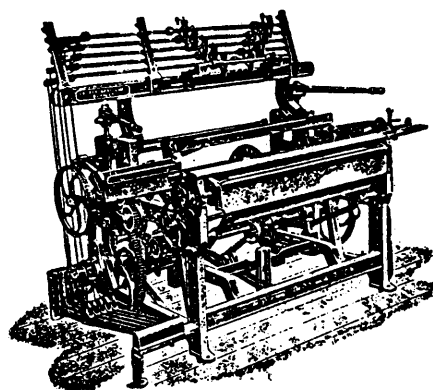

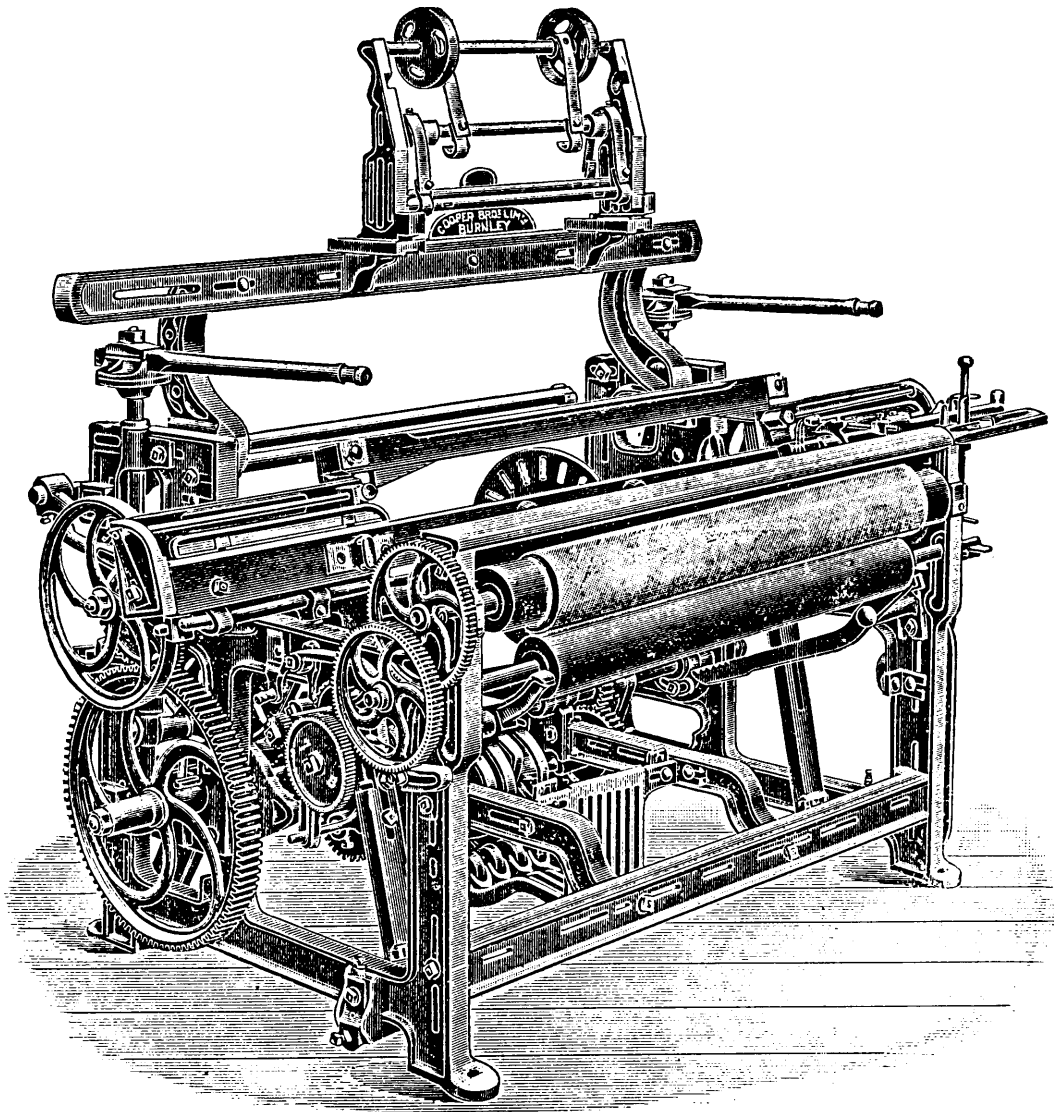

Makers of MODERN HIGH-SPEED LOOMS

For Weaving Light, Medium, or Heavy Cloths. Inside Treading Motions with Roller Tops
or Spring Tops. Outside Treading Motions with Cross Rods.

.....
COOPER BROS., Ltd., Bethesda St. Foundry,
BURNLEY.

ESTABLISHED 1844

HARLING & TODD, Ltd.,

MAKERS OF HIGH-CLASS
WEAVING & PREPARATION MACHINERY.

LOOMS

For Weaving Light, Medium, or Heavy Goods, up to 140 ins. Reed
Space, with inside or outside Treading.

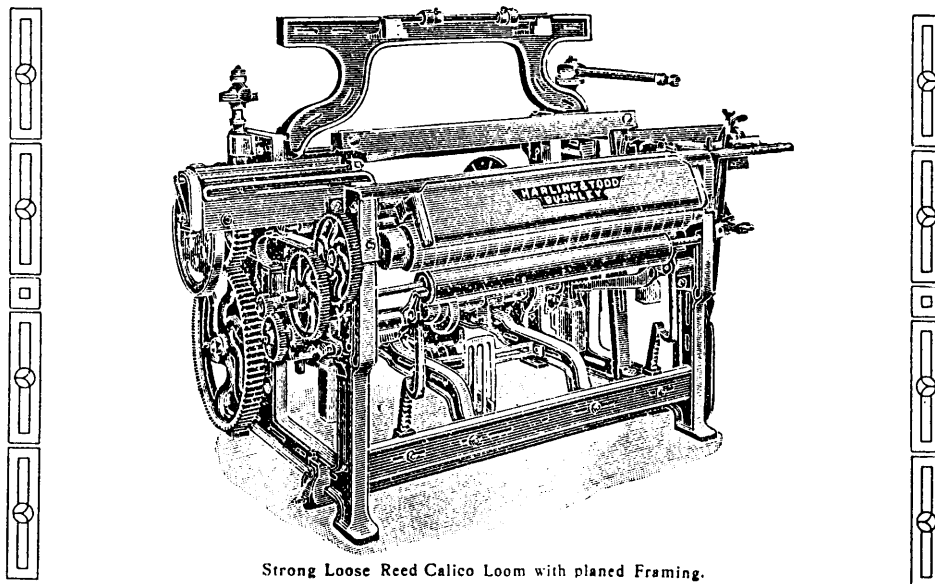

Strong Loose Reed Calico Loom with planed Framing.

DROP BOX AND REVOLVING BOX LOOMS.
SIZING, BEAMING, AND PLAITING MACHINES.
WINDING FRAMES, HYDRAULIC AND GEARED PIECE PRESSES.
THE "HARLING" AUTOMATIC WEFT REPLENISHING LOOM.
SINGLE AND DOUBLE JACK DOBBIES, SPRING TOPS, Etc., Etc.

Manchester Royal
Exchange, Tuesday
and Friday,
2-0 to 3-0 p.m.
Pillar 14.

**ROSEGROVE IRONWORKS,
BURNLEY, ENGLAND.**

'Phone :
190 BURNLEY.
Wires :
'LOOMS' Burnley.
Code : 5th Ed., A.B.C.

OUR SPECIALITY IS
OVERHEAD RUNWAYS

AS APPLIED TO

Mills, Weaving Sheds & Warehouses.

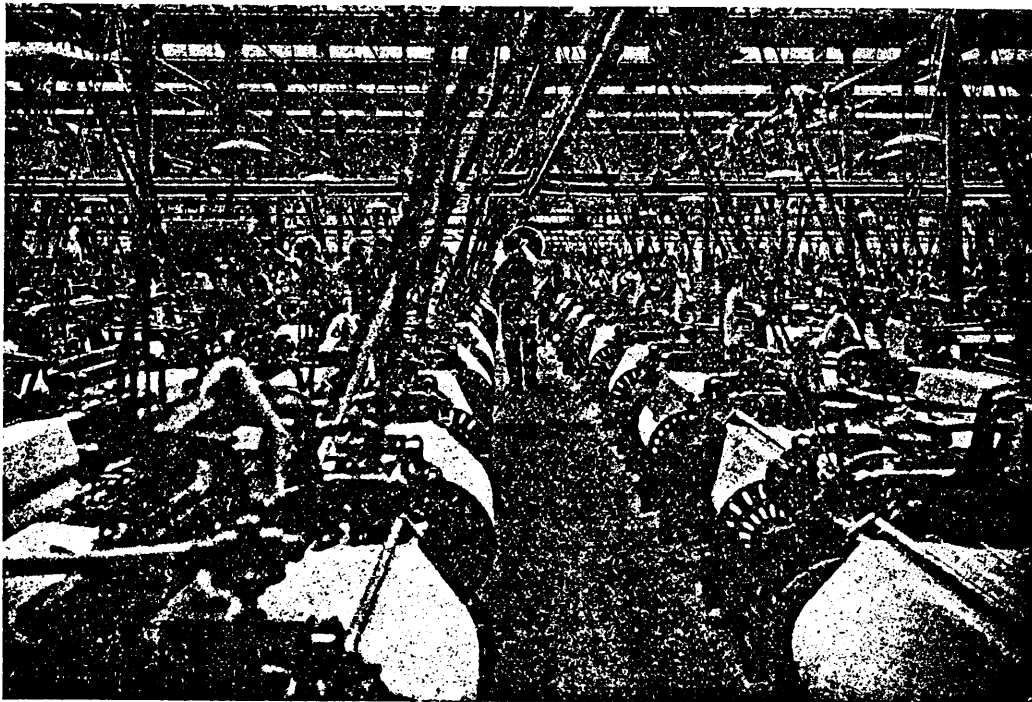

When YOU consider the question of bringing your Mill Up-to-Date, write us.

JAMES SOUTH,

RAKE HEAD IRONWORKS,

Net. Tel. 19. **BURNLEY.**