

COMPENDIOUS HISTORY
OF THE
COTTON-MANUFACTURE;

WITH
A DISPROVAL OF THE CLAIM
OF
SIR RICHARD ARKWRIGHT

TO THE INVENTION OF ITS
INGENIOUS MACHINERY.

BY RICHARD GUEST.

Manchester:
PRINTED BY JOSEPH PRATT, CHAPEL WALKS,
AND SOLD BY
E. THOMSON, MARKET-STREET, AND W. AND W. CLARKE, MARKET-PLACE:
LONGMAN, HURST & Co. AND G. & W. B. WHITTAKER, LONDON.

—
1823.

CONTENTS.



	PAGE.
CHAPTER I.	
<i>National and general Importance of the Cotton Manufacture</i> - - -	3
CHAPTER II.	
<i>Early Modes of Spinning and Weaving</i> - - -	6
CHAPTER III.	
<i>Improved Methods of Management and Disposal of Manufactured Cottons</i> - -	10
CHAPTER IV.	
<i>Invention of the Spinning Jenny</i> - - -	12
CHAPTER V.	
<i>Invention of the Water Frame, or Throstle</i> - - -	16
CHAPTER VI.	
<i>The Carding Engine</i> - - -	18
CHAPTER VII.	
<i>Some Account of the Life of Sir Richard Arkwright</i> - - -	20
CHAPTER VIII.	
<i>Mis-statements of the foregoing Facts</i> - - -	29
CHAPTER IX.	
<i>Invention of the Mule and Exportation of Twist</i> - - -	31
CHAPTER X.	
<i>Change of Character and Manners, in the Population, superinduced by the extension of the Cotton Manufacture</i> - - -	36
CHAPTER XI.	
<i>Moral and Religious Character of Weavers</i> - - -	40
CHAPTER XII.	
<i>The Steam Loom</i> - - -	44
APPENDIX:—	
No. 1. The Statement of Thomas Leather - - -	53
No. 2. Certificate of the Burial of Mary Leather - - -	54
No. 3. Evidence of Thomas Highs - - -	55
No. 4. Evidence of John Kay - - -	62
No. 5. Evidence of Sarah Kay - - -	69

ERRATA.

In Page 20, line 10, for *appaling* read appalling.

In Page 20, line 23, for *Anteus* read Antieus.

In Page 30, line 21, for *Voila ce que l'histoire*, read **Voila** c'est que c'est que l'histoire. This observation is, in the hurry of composition, erroneously attributed to Louis the 14th. It was made by Henry the 4th of France, after the Battle of Aumale, where he was wounded.

In Page 41, line 9, for *exhiling* read exiling.

In Page 11, line 6, for *practise* read practice.

CHAPTER I.

National and General Importance of the Cotton Manufacture.

THE present age is distinguished beyond all others by the rapid progress of human discovery. Man respired the air of his atmosphere for many ages, before he discovered it to be a substance possessing weight and the other properties of material bodies; but it was reserved for our own times to ascertain that it and the other æriform fluids, which from their subtlety and invisibility would seem to elude human scrutiny, were chiefly compound bodies susceptible of Analysis and Classification. The science of Aerostation—the means of enabling miners to work in safety in the midst of an inflammable atmosphere, and the illuminating of our Streets and Houses with subterraneous fire, have followed. Water and Fire have been brought to flow in peaceful association under the feet of the inhabitants of our towns, to administer to their wants and promote their pleasures. The double condensing Steam Engine, and its application to Navigation, may almost claim the merit of original inventions, and will in their consequences to Man, perhaps not be second to the boast of former ages—the discoveries of the Magnet, of Gunpowder, and of Printing. They have subjected to Man a Giant, by whose assistance he can obtain the treasures of mines hitherto unapproachable by reason of subterraneous waters—draw ponderous loads of fuel, limestone or other substances, along rail ways without the help of beasts—set in motion machinery, to which mere human strength was unequal—cross the seas independent, and even in despite of winds and tides, and with a rapidity before unknown. To these might be added the Voltaic Pile, Vaccination and others equally splendid and original.

One, however, which would seem to merit the attention of the Philosopher from its ingenuity, the Englishman from its having brought an immense increase of wealth and population to his territory, and all from its economizing human labour and enabling many articles of clothing to be obtained at a less expensive

rate, has obtained comparatively little attention. While admiration has been unboundedly lavished on other triumphs of the mind, the successive inventions and improvements of the Machinery employed in the Cotton Manufacture, have obtained neither the notice which their own ingenuity, nor their national importance required. They have been the great means of increasing the population of the county of Lancaster, in the first ten years of the present century, from 672,731 to 810,539, and, in the subsequent ten years, from that number to 1,052,859, (a rate of more than doubling itself in half a century,) and of producing a corresponding increase of wealth and intelligence. Under the influence of the manufacture of which they have been the promoters, the town of Manchester has, from an unimportant provincial town, become the second in extent and population in England, and Liverpool has become in opulence, magnitude, elegance and commerce, the second Seaport in Europe. That Liverpool is a consequence of the Cotton Manufacture, and indebted to Manchester and its dependencies for its greatness, is evident on general principles. The origin of a Manufacturing town is this: a Manufactory is established, a number of labourers and artizans are collected—these have wants which must be supplied by the Corn Dealer, the Butcher, the Builder, the Shop-keeper—the latter when added to the Colony have themselves need of the Draper, the Grocer, &c. Fresh multitudes of every various trade and business, whether conducive to the wants or luxury of the inhabitants, are superadded, and thus is the Manufacturing town formed. The causes of its increase and greatness rest within itself—they are primary and original. But the formation and increase of a Seaport town, proceed from secondary causes. A commercial Seaport pre-supposes, that the inhabitants of the interior have wants to be supplied through it, or that they have a superfluity of their own productions to exchange for the commodities of other nations. The Seaport may decline without injuring the Manufacturing town, but if the demand of the Manufacturing town for foreign produce should diminish, or if it should no longer have productions of its own to export, or if that commerce of which it is the cause and the nucleus, should flow into another channel, the business of the Seaport is at an end. These two great Towns, then, which, with their connections and dependencies, are almost an equipoise to the Metropolis, are a consequence of the Cotton Manufacture.

The Machinery employed in the Cotton Manufacture is little known except to the manufacturers themselves, and the History of its progressive improvements, perhaps, scarcely to them. For the greatest improvements we are indebted to a man in humble life, whose poverty and want of patronage prevented him from

either reaping the pecuniary benefit, or establishing his claims to that fame to which his ingenuity entitled him. By borrowing his ingenious inventions the late Sir Richard Arkwright lived to acquire a princely fortune, and died with the reputation of being one of the most eminent of those individuals, who have enlarged the resources of their native country, and made her manufactures and machinery the wonder of surrounding nations; while the man to whose painful labours and ingenious contrivances Sir Richard was indebted for these honours, lived in obscurity, and died in indigence:

Sic vos non vobis mellificatis apes,

Sic vos non vobis fertis aratra boves.—*Virgil.*

To him Sir Richard in his greatness held out no fostering hand—he not only reaped the harvest himself, but assumed the reputation of having sown the grain; and whether from shame, from vanity, or indifference, left the author of his fame to languish in his original poverty.

CHAPTER II.

Early Modes of Spinning and Weaving.

The original Mode of converting the fleecy contents of the fruit of the cotton tree into Thread, for the purpose of being woven into Cloth, was the distaff and spindle, and this mode is still used in Hindostan.* The distaff is a wooden rod, with a bundle or fleece of cotton wool tied loosely round the top of it.

The spinner holds the distaff between the left arm and the body, his left hand is nearer to the distaff than the right, the hands are kept about two inches asunder, and pull from the fleece a continuous lock of cotton wool, the right hand drawing out and twisting so much of the lock as is between it and the left hand into a fine thread, which is farther twisted by a pendent spindle, or bobbin, which is kept constantly twirling round, and on which the thread is afterwards wound. See plate 1.

This tedious process was the one used from the earliest ages, and might be the occupation to which Hector sends Andromache:

Ἄλλ' εἰς οἶκον ἰοῦσα τὰ σαυτῆς ἔργα κόμιζε,
Ἴστόν τ', ἡλακάτην τε, καὶ ἀμφιπόλοισι κέλευε
Ἔργον ἐποίχεσθαι.—*Hom. Il. Lib. vi. 490.*

The general likeness between a mast, which is another sense of Ἴστόν, and the distaff, favours the supposition.†

The state of the Cotton Manufacture in the county of Lancaster, at the commencement of the last century, was as follows: The warp, or longitudinal

* The superiority of texture and the durability of the India Nankeens, and Long Cloths, are owing to this mode of spinning, which disposes the fibres of the cotton more evenly, and twists them more into the body of the thread than the spinning machines do.

† For this criticism, I am indebted to my friend Mr. Littler, Solicitor, Leigh.

threads of the cloth, was linen yarn, imported in the hank or bundle, from Germany. The weaver bought it himself, and prepared it for the Loom by arranging it in parallel lines: this operation, called warping, was done upon pegs fastened into a wall; the warps were from twelve to twenty-five yards long, and were warped or arranged in parallel lines, a single thread at a time, by passing the yarn round the pegs. See plate 2. The threads were also divided into two equal parts, each alternate thread being in the upper half of the warp, and the other threads in the lower half, and this division, called the lesse, was carefully preserved during the weaving, the upper half passing through one heald, and the lower through another. The weft, or transverse threads of the cloth, was made from Cotton, which was also bought by the weaver.

The Cotton was beaten, picked and cleaned from dirt and impurities, and then carded, or brushed with coarse wire brushes. The carding was done by hand cards about twelve inches long, and five inches wide; the carder holding one in each hand. See plate 3, figure. 1. The Cotton, after being picked and cleaned, was spread upon one of these cards, and was brushed, scraped or combed with the other, until the fibres of the cotton were all disposed in one direction; it was then taken off in soft fleecy rolls, about twelve inches long, and three quarters of an inch in diameter. These rolls, called cardings, were converted into a coarse thread or roving, by twisting one end to the spindle of a hand wheel, turning the wheel which moved the spindle with the right hand, and at the same time drawing out the carding horizontally with the left. See plate 3, figure 2. The motion thus communicated to the carding twisted it spirally; when twisted, it was wound upon the spindle, another carding was attached to it, drawn out and twisted: thus was formed a continued coarse thread or roving. The rovings were then taken to the spinner to be converted into weft. The hand wheel was again used for this purpose, and the rovings were drawn out into weft nearly in the same manner as the cardings were made into rovings. See plate 3, figure 3.

The double operations of roving and spinning were requisite, because the cardings could not at once be drawn out into a level and even thread, fine enough for the loom; roving or coarse spinning reduced the carding to the thickness of a quill, and the spinner afterwards drew out and twisted the roving into weft fine enough for the weaver. The warp was placed between two beams about five feet asunder; half way between the beams the warp passed through a framework of looped threads, called healds, each alternate thread of the warp going

through one heald, and the other threads through the other heald. The healds were worked by two treddles, which upon one being put down by the foot, raised one half of the healds and every second thread of the warp; the shuttle which contained the weft was then thrown by the right hand between the threads which were at rest, and the second or alternate threads raised by the treddle and the healds; the shuttle was caught on the other side by the left hand, and the weft thus transversely shot between the threads of the warp was driven by the reed close to the cloth made by former casts of the shuttle. The other treddle was then put down, which raised the other healds and the threads of the warp, which had before been at rest; the shuttle was thrown by the left hand to the right, leaving another transverse thread, which was again driven by the reed close to the former one. See plate 4, fig. 1. In weaving cloth above thirty-six inches broad, two men were required to one loom, because one man could not extend his arms sufficiently to throw the shuttle through the warp from one hand to the other; two were consequently necessary, one on each side of the loom, to receive and throw back the shuttle. The goods thus manufactured were called Fustians, and were sold in the grey by the weavers to the Manchester merchants.

It was not until 1740, that the Manchester merchants began to give out warps and raw cotton to the weavers, receiving them back in cloth, and paying for the carding, roving, spinning and weaving. After the fustians were manufactured the merchants dyed them, and then carried them to the principal towns in the kingdom on pack-horses, opening their packs and selling to the shopkeepers as they went along.

In 1733 a Mr. Wyatt, of Litchfield, invented a machine for spinning cotton, and two factories were built and filled with his machines, one at Birmingham, and one at Northampton. Both these undertakings failed; the machines have long ago perished, and no model or description of them remains. We find no farther attempts to spin by machines until 1764.

In 1738 Mr. John Kay, a native of Bury, in Lancashire, but at that time residing at Colchester, invented a new mode of throwing the shuttle. By this invention the lathe was extended a foot on each side of the warp, in which foot an impetus was given to the shuttle, by means of the picking peg held by the weaver in his right hand, which drove it across the warp and back again, without being thrown by the workman's hands. See plate 4, fig. 2 and 3. This plan of throwing the shuttle, the one now in use, enabled the weaver to make nearly double the quantity of cloth he could have made on the old system,

and enabled one man to weave the widest cloth. Mr. Kay brought this ingenious invention to his native town, and introduced it among the woollen weavers in the same year, but it was not much used among the cotton weavers until 1760. In that year Mr. Robert Kay, of Bury, son of Mr. John Kay, invented the drop box, by means of which the weaver can at pleasure use any one of three shuttles, each containing a different coloured weft, without the trouble of taking them from and replacing them in the lathe. About this time, also, the warping mill was introduced into the cotton manufacture. The warping mill is a prismatic reel about six yards in circumference, and six or seven feet in height. This reel is turned round on a vertical axis by a band, from a pulley or wheel, which is turned by the warper. The bobbins which contain the yarn are placed on a frame a yard or two distant from the reel, and the threads from them pass through a slide which moves perpendicularly up and down an upright piece of wood; this slide is suspended by a cord coiled round the axis of the reel. After dividing, crossing, and wrapping the threads round wooden pins placed at the top of the reel, the reel is turned, the slide descends by the uncoiling of the cord from the axis, and the threads are wound about the reel. When one hundred, or one hundred and twenty yards, according to the length of the warp required, are wound upon the reel, the threads are crossed and wrapped round other wooden pins placed at the bottom of the reel. The reel is then turned the contrary way, the cord coils round the axis, the slide ascends, and the threads are again wound about the reel. These operations are repeated until the requisite number of threads are arranged upon the reel. See plate 5.

CHAPTER III.

Improved Methods of Management and Disposal of Manufactured Goods.

About 1750 there arose a second rate class of merchants, called **Fustian Masters**; these resided in the country and employed the neighbouring weavers, and the mode of conducting the manufacture at that time was as follows:—The master gave out a warp and raw cotton to the weaver, and received them back in cloth, paying the weaver for the weaving and spinning; the weaver, if the spinning was not done by his own family, paid the spinner for the spinning, and the spinner paid the carder and rover.*

* The weft spun in 1760 was of six different qualities, six-penny, eight-penny, ten-penny, fifteen-penny, eighteen-penny, and two shillings, so called from the price per pound paid for the weaving. The six-penny was about five hanks to the pound, the eight-penny about six, and the ten-penny about eight hanks to the pound; the fifteen-penny, eighteen-penny, and two shillings, were about eleven, thirteen and sixteen hanks to the pound. A hank is eight hundred and forty yards. These wefts were made into goods called pillows, chains, thicksetts, barragons and denims.

The weaving of a piece containing twelve pounds of eighteen-penny weft, occupied a weaver about fourteen days, and he received for the weaving	} 18 0
The spinning of the weft at nine-pence per pound, amounted to	- - 9 0
The picking, carding, and roving at nine-pence per pound, amounted to	- - 9 0
	£1 16 0

Thus when the weaver took home the piece, he received thirty-six shillings, out of which he paid the spinner eighteen shillings, the spinner paying nine shillings for the carding and roving. A weaver required three grown persons to supply him with weft. There were also finer qualities of weft spun for cotton velvets, some as fine as forty hanks to the pound. Forty hanks weft sold for six shillings per pound, including carding, roving and spinning.

In 1760, Oats were 2s. per bushel, 45 lbs.
Wheat was 5s. do 70 lbs.
Meal 20s. per load.
Jannock, 15 lbs. for 12d.

The Master attended the weekly market at Manchester, and sold his pieces in the grey to the Merchant, who afterwards dyed and finished them. Instead of travelling with their goods on pack-horses, the Merchants or their Travellers now rode from town to town, carrying with them patterns or samples, and on their return home the goods sold during the journey were forwarded by the carriers' waggons.

This practice, far more commodious than the rude and inconvenient mode of carrying their merchandize from town to town, has become general, not only in this, but in every other business; and it may now be asserted, that the whole of the internal wholesale trade of England is carried on by Commercial Travellers—they pervade every town, village and hamlet in the kingdom, carrying their samples and patterns, and taking orders from the retail tradesmen, and afterwards forwarding the goods by waggons, or canal barges, to their destination;—they form more than one half of the immense number of persons who are constantly travelling through the country in all directions, and are the principal support of our Inns, the neatness and comfort of which are so much celebrated throughout Europe. The commercial travellers are in a great measure the causes of this neatness and comfort, for they soon find out the best houses of entertainment; and, being gregarious, the news is readily communicated, and the best houses of course become more frequented: a circumstance which excites emulation among the Innkeepers. These travellers are a body of men exhibiting intelligence and acuteness, combined, in many instances, with self-conceit and the superficial information acquired by reading newspapers.

Malt, was	23s. per load,
A Goose,	15d.
Cheese,	2¼ per lb.
Beef,	2d. per lb.
A Neck of Mutton,	9d.

Land let for 40s. or 45s. the Cheshire acre, and a weaver's cottage, with a two-loom shop, for 40s. or 50s. per annum.

CHAPTER IV.

Invention of the Spinning Jenny.

About 1760 the Manchester Merchants began also to export Fustians in considerable quantities to Italy, Germany, and the North American Colonies, and the cotton manufacture continued to increase until the spinners were unable to supply the weavers with weft. Those weavers whose families could not furnish the necessary supply of weft, had their spinning done by their neighbours, and were obliged to pay more for the spinning than the price allowed by their masters; and even with this disadvantage, very few could procure weft enough to keep themselves constantly employed. It was no uncommon thing for a weaver to walk three or four miles in a morning, and call on five or six spinners, before he could collect weft to serve him for the remainder of the day; and when he wished to weave a piece in a shorter time than usual, a new ribbon, or gown, was necessary to quicken the exertions of the spinner. It is evident that an important crisis for the Cotton Manufacture of Lancashire was now arrived. It must either receive an extraordinary impulse, or, like most other human affairs, after enjoying a partial prosperity, retrograde. The spinners could not supply weft enough for the weavers. The first consequence of this would be to raise the price of spinning. In the then state of manners and prejudices, when the facilities of communication between places were less, and the population generally possessed with much greater antipathy to leaving their native place than at present, this inducement would have failed to bring together a sufficient number of hand spinners, and a farther rise in the price of spinning must have been the consequence. This would have rendered the price of the manufactured cloth too great to have been purchased for home or foreign consumption, for which its cheapness must of course have been the principal inducement.

In this strait a means of obviating the difficulty was found in a quarter where it could have been least expected. A reed maker, of the name of Thomas Highs, residing in the town of Leigh, in Lancashire, one forenoon in the year 1763 or 4,

being in the house of one of his neighbours, whose son, a weaver, had come home after a long, ineffectual search for weft, was, by the circumstance, roused to consider whether a machine could not be invented to produce a more plentiful supply of weft. He engaged one Kay, a clock maker, to make him the wheels and other apparatus of his machine, and they worked together in a garret in Highs' house. The chamber door was kept locked, and they worked at over hours with great assiduity and perseverance for several months. All their trouble and pains were, however, abortive, and one Sunday evening, in a fit of despondency, they threw the machine through the garret window, into the yard.—During their labours they were often jeered by their neighbours with enquiries for weft, and after the catastrophe of the garret window, the derision broke out without restraint. Kay was asked what wages his master gave him for making spinning wheels, to which he replied, that he had done with spinning; and then joined in the laugh with his neighbours. Highs was not so easily discouraged; his persevering mind, though foiled, was not subdued. He took the broken wheels once more to his garret, and after another effort produced the ingenious machine known by the name of the Spinning Jenny, and which he so called after his daughter, her christian name being Jane. The first Jenny was about a yard square, and worked only six spindles, which he afterwards increased to twenty and twenty-five.

In spinning with the hand wheel, the roving was taken fast hold of betwixt the left fore finger and thumb, at six inches distance from the spindle; the wheel, which by a band gave motion to the spindle, was then turned with the right hand, and at the same time the left hand, holding the roving fast as before-mentioned, was drawn back about half a yard; the roving was thus drawn out into weft, the necessary twist was then given by a few turns of the wheel, and finally the weft was wound upon the spindle. See plate 3. fig. 3. Highs' Jenny performed these operations in the following manner:—The spindles were placed in front, and a string from each spindle went round a wooden drum or cylinder, which turned on a perpendicular axis. The drum was turned by an horizontal handle. The rovings were fixed on skewers at the back of the Jenny, each roving passing through a separate loop of wire placed about eighteen inches higher than the spindles and skewers, and half way betwixt them. At each of the front corners of the Jenny stood an upright post, three feet higher than the spindles; these posts were grooved perpendicularly on the inside from their tops to the level of the spindle. Two flat pieces of wood, made to open and shut something like a parallel ruler, but opening and shutting vertically, and not laterally, went across the front, their ends

fitted into the two grooves, and they were worked perpendicularly from the spindles to the tops of the posts, by a cord which coiled round a moveable bobbin fixed upon the axle of the drum. When the bobbin was on the lower part of the axle, it turned with it, but when lifted nearer the handle, the axle turned and the bobbin remained stationary. When the pieces of wood, called the clove, were raised to the proper height, the bobbin was lifted by a latch, and the clove remained suspended until lowered by the hand of the spinner. From the wire loops the rovings passed between the flat rulers, or clove, to the spindles. After shutting the clove, or in other words, fastening the roving between the two edges of the rulers, he turned the drum, which set the spindles in motion and raised the clove, drawing out the portion of roving between the clove and the spindles. When drawn out, he lifted the bobbin, the clove thus remained stationary while he gave the weft the proper degree of twist by a few turns of the drum. The clove was then lowered, which wound the weft upon the spindles. See plate 6. Some improvements were afterwards made in the structure of the Jenny, by James Hargrave, of Blackburn. These improvements consisted in placing the spindles at the back, and the rovings and the clove at the front. In the improved Jenny the clove moves horizontally from the spindles when drawing out the rovings, and towards them when copping the weft. See plate 7.

The Encyclopædias state that the merit of the invention of the Jenny is due to Hargrave; but he was not the original inventor, for even if he did make a Jenny in 1767, as stated by them, Highs had made Jennies two or three years before: this, however, is evidently a mistake. The fact of Highs having completed the Jenny in 1764, is proved by the statement of Thomas Leather, see Appendix Nos. 1 and 2, where he states that his father, Richard Leather, a wheelwright, took a public house, the Seven Stars, in the Walk, in Leigh, and went to live at it in May, 1763. On the death of his wife he declined selling ale, and he left the house in May, 1766. During the three years that Leather lived in this house, Highs and Kay were his next, and next but one door neighbours, and in the first or second of those years, Highs invented the Jenny.

“The case of Mr. Richard Arkwright and Co.” published in 1781, contains a short account of different inventions for the spinning of Cotton, and says:—“About the year 1767 one Hargrave, of Blackburn, constructed an engine that would at once spin twenty or thirty threads into yarn for the fustian manufacture.” This account has been copied by Dr. Aikin, in his History of Manchester, by the editors of the Encyclopædias, and by other writers. The word “con-

structed" used in Mr. Arkwright's pamphlet, has been changed into "invented," and the merit of the invention erroneously attributed to Hargrave. It was convenient for Mr. Arkwright, and served his purpose, to attribute the invention of the Jenny to Hargrave, because Hargrave was not the inventor of the Water Frame, the talisman of Arkwright's fortune, and which, by his case or memorial, he was then seeking to engross to himself; to have mentioned Highs, the real inventor of the Jenny, might have been a dangerous experiment, because, as Mr. Arkwright well knew, Highs was the inventor of the Water Frame as well as the Jenny.

CHAPTER V.

Invention of the Water Frame, or Throstle.

The Jenny was only applicable to the spinning of the Weft or transverse threads, but having been successful in his first effort, Highs was induced to prosecute his inventions, and endeavour to complete a machine which should spin Cotton to that degree of hardness and fineness required in the yarn for the warp, or longitudinal threads, which hitherto had been made from foreign linen yarn. In this attempt, after much labour and meditation, he was equally successful as in the former instance. He produced a second original machine, unlike to, and uncompounded of, the former one, which equalled its precursor in its great effects, and surpassed it in ingenuity. In this new attempt he placed the rovings on skewers at the back of the machine; from the skewers the rovings passed between two rollers, placed horizontally, the one above the other; the lower roller was furrowed or fluted lengthwise, and the upper one was covered with leather. These rollers, each about an inch in diameter, revolved in close contact, drawing the rovings slowly from the skewers. A similar pair of rollers, but revolving five times whilst the first pair revolved once, were placed nearer the front. The second pair, by turning quicker, pulled at the roving much faster than it was given out by the first pair, and as both pairs pressed it fast between the sharp fluted edges and the leather, this pulling of the second pair drew it out and lengthened it.* The first pair drew the roving from the skewer as the

* Dr. Aikin in his *History of Manchester*, 4to. London, 1795, page 172, describes this machine in the following manner:—"The cotton to be spun is introduced through three sets of rollers, so governed by the clock work, that the set which first receives the cotton makes so many more revolutions than the next in order, and these more than the last which feed the spindles, that it is drawn out considerably in passing through the rollers." The effect of the machine, as described by Aikin, if it could act at all, would be to reduce the roving to its original state.

left hand of the distaff spinner draws it from the distaff, the second pair supplied the place of the right hand and stretched it to the proper fineness. From the second pair the thread passed to a spindle in front of the machine; this twisted the thread and wound it upon a bobbin. The different revolutions of the rollers were regulated by brass wheels or clock-work, and the spindles were turned by strings from a drum. See plates 8 and 9. Highs employed Kay to make this machine, giving him a model in wood, which Kay executed in metal, and soon after it was completed Kay went to live at Warrington, his former place of residence before he lived at Leigh. This second machine, now called the Water Frame, or Throstle, requires considerable power to put it in motion, and can only be worked to advantage in factories, which, before the application of the Steam Engine, as a moving power, were turned by water falls, and hence came the name of Water Frame. The Yarn spun on the Water Frame is much harder twisted than yarn spun on the Jenny, and on that account is more peculiarly adapted for warps. Until the introduction of the Mule, the yarn or twist for warps was spun from cotton in the Water Frame factories, whilst the weft was spun by the families of the weavers, on the Jenny, which requires no power but the hand of the spinner, and which is equally well calculated for the factory or the cottage.

Highs kept the Water Frame as secret as possible; it was his favourite invention, and he promised himself much future advantage from it. The Jenny he made public; but the Roller Spinning he endeavoured to keep to himself, until he could raise money sufficient to establish a factory. In his evidence, given in the Court of King's Bench, in the trial of the King against Arkwright, in June, 1785, he says he did not follow up the invention because he wanted means, being poor and having a large family, but thought to follow it up when he became a little abler, and could get a friend to assist him.

The interview at the Inn, at Manchester, between him and Arkwright, described in his simple and unassuming manner, is highly pathetic and interesting. See Appendix No. 3.

CHAPTER VI.

The Carding Engine.

The invention of the **Jenny and Water Frame** caused an increased demand for cardings and rovings, and the carders were soon unable to furnish the necessary supply. **Stock Cards** were introduced. In this improvement the cards are double the size of hand cards. One is fixed to a stool or stock, and the other combed against it with both hands—but these did not afford an adequate quantity, the difficulty, however, was finally obviated by the invention of the **Carding Engine**.

The **Carding Engine** was not invented at once, nor by any particular individual, but was the result of a succession of improvements, made at various times, and by different persons. In this machine a wooden cylinder, covered with cards, turning on an horizontal axis, revolves immediately under a concave cover; this cover is also lined with cards, and the teeth of the cards on the cylinder and of those on the cover, are nearly in contact. Originally, the cotton was spread upon the cylinder, and the cylinder by its revolutions carded the cotton against the teeth on the cover: the cotton was then taken off the cylinder by hand cards held against it. A great improvement was afterwards made by adding a second cylinder, which took the cotton off the first as fast as it was carded, and a roller, fluted longitudinally, and turning on an horizontal axis, pressed against this second cylinder and rubbed off the carded cotton in stripes. The inventor and improver of this machine are unknown.

In 1772, **John Lees** invented the **Feeder**. In this improvement the cotton is spread upon an endless piece of cloth, stretched upon two rollers; as the rollers revolve the cloth moves nearly in contact with the first cylinder, which takes the cotton from the cloth. Other improvements have been added: the cotton is now taken from the **Feeder** by two small rollers; these pass it to another small

roller, which last delivers it to the cylinder. See plate 10, fig. 2. The fluted roller, in rubbing off the cotton, injured the cards, and was in other respects awkward and inconvenient.

In 1772, James Hargrave, the improver of the Jenny, invented the Crank and Comb, a curious and most ingenious contrivance for taking the cotton off the cylinder. A thin plate of steel, toothed at the edge like a tennant saw, is worked in a perpendicular direction by a crank, and striking at short intervals against the cylinder, shaves off the cotton in fleeces or cardings. See plate 10, figs. 2 and 3. The cards were nailed on both cylinders in longitudinal stripes, each stripe of card being placed parallel to the axis of the cylinder. These stripes were five or six inches broad, and from twelve to twenty inches long, according to the length of the cylinder. In the circumference of the second cylinder there were eight or ten stripes, and as the spaces between these stripes did not act upon the carded cotton, the fleece was broken off at each interstice; these broken fleeces were by the Crank and Comb, divided into four or more cardings, each carding being about an inch in diameter and twelve or twenty inches long.

In 1773, Thomas Highs, and in 1774, a Mr. Wood, obtained a perpetual or endless carding, by nailing the cards on the second cylinder circularly, instead of longitudinally. Highs used two cylinders equal in size; Mr. Wood's second cylinder was smaller than his first. In this improvement the stripes of card go round the cylinder, instead of being placed parallel to its axis, and as there is no break, space, or interstice in the circumference of the second cylinder, it takes the cotton from the first in a uniform and unbroken fleece. See plate 10, figs. 4 and 5. Hargrave's Comb separates this fleece from Mr. Wood's cylinder without destroying its continuity, and it afterwards passes through a funnel, and between two rollers into a tin can. See plate 10, figs. 1, 2 and 3. The cardings are then taken to the Roving Frame; the Roving Frame consists of a system of rollers and spindles similar to those in the Water Frame; the rollers draw the cardings out of the can and lengthen them, and the necessary twist is given by the spindles. See plate 11, figs. 1 and 2.

Mr. Arkwright, in his Roving Frame, used a can revolving on a vertical axis; this can had the same effect as the spindles in twisting the rovings, and was used for that purpose as early as 1759, by Benjamin Butler. See plate 11, fig. 3.

CHAPTER VII.

Some Account of the Life of Sir Richard Arkwright.

Sir Richard Arkwright was a rare instance of one, who from a very inferior situation in life, by dint of indefatigable perseverance, unity of object and able management of the men he had to deal with, amassed a large fortune and raised himself to great eminence. With no original invention to boast of in the department of mechanics, to which he devoted himself, he possessed unwearied zeal and patience in obtaining the discoveries of others, and great skill in combining them and turning them to his own purposes. Whether he had a natural turn for the mechanics, or whether he had sharp sightedness and sagacity enough to discover the land of promise through the haze which surrounded him, and was thus induced to seek after inventions for spinning, does not appear; but he had the same appalling obstacle to surmount which Highs himself had—the *res angusta domi*—nothing could be done by either, without capital. The modest spirit of Highs shrunk from the humiliation of soliciting partnerships or patronage; he was incapable of dressing up his projects and expectations in the pomp of promise and the alluring colours of confident prediction and plausible calculations—a quality much more necessary to a projector than the real merits of his scheme. Highs' proper arena was in his garret, among his wheels and machines; it was here that his peaceful successes were achieved; but the sphere of Arkwright was in the world and amongst men. It was there that his bustling activity was in its proper element, and there that his successes equalled those of Highs in his garret. Arkwright succeeded very unaccountably in finding fresh partnerships, though former ones were dissolved in consequence of their not answering, and he always came richer from the misfortune, like Anteus, who in his falls gained strength from his mother earth.

Richard Arkwright was born at Preston, in the county of Lancaster, on the 23rd of December, 1732.* In the year 1760, he lived at Bolton-le-moors, in the same county. At this time he was a barber, but soon after he travelled through the country buying human hair. He possessed a valuable chemical secret for dying it, and when it was dyed and prepared he sold it to the wig makers. Mr. Richardson, hair dresser, of Leigh, tells me that Arkwright's hair was esteemed the best in the country.

In 1761, Arkwright married Margaret Biggins, of the township of Pennington, and parish and town of Leigh,† and his marriage brought him acquainted with Highs and his inventions. His knowledge of them, however, was not obtained from Highs himself; he went to work in a more crafty and circuitous manner. Having learnt that Kay, who then resided in Warrington, had been Highs' workman, he introduced himself to Kay in the summer of 1767, by employing him to turn some brass, or wheels, and when he had called two or three times on Kay, he took him to a public house and treated him with wine, telling him that he was endeavouring to discover the perpetual motion, and that the turned brass was for a machine on that principle. Kay dissuaded him from the attempt, and advised him to turn his attention to making a machine for spinning cotton. Ah! said Arkwright, that will never be brought to bear; several gentlemen have almost ruined themselves by it. Kay replied he could bring it to bear. This was exactly what Arkwright wanted, and the following morning, early, he went to Kay's bedside, reminded him of their last night's conversation, and eventually succeeded in procuring from him a model of Highs' machine, the Water Frame, or Throstle. In this model Arkwright found the perpetual motion he wanted, as well as the philosopher's stone.

* The following certificate is copied from the Parish Register of Preston Church:—"Christenings in December, 1732. Richard, son of Thomas Arkwright, born 23rd, baptized 31st."

The above is truly copied from the Register of baptisms for the Parish of Preston, for the year 1732. Witness my hand, this seventh day of August, 1823,

Anthony Hammond, Curate.

† The following certificate is copied from the Parish Register of Leigh Church:—"Banns of marriage. Richard Arkwright, of the Parish of Bolton, Barber, and Margaret Biggins, of this Parish of Pennington, Spinster, were married in this Church, by licence, with consent, this twenty-fourth day of March, in the year one thousand seven hundred and sixty-one, by me Ja: Hartley, Curate. This marriage was solemnized between us, Richard Arkwright, Margaret Biggins. In the presence of S. Simpson, Lawrence Brandwood. No. 100."

A true copy, taken from the Parish Register, by me *Samuel Whittle*, Parish Clerk, March 6, 1822.

Arkwright shewed the model to several gentlemen, with the view of procuring pecuniary assistance to enable him to build a factory, and having prevailed on Mr. Smalley, of Preston, to afford that assistance, he returned to Warrington and hired Kay to work for him, securing his secrecy for a certain number of years by a bond. In April, 1768, he took Kay with him to Nottingham, where he built a factory turned by horses. In 1769, July 3rd, he obtained a patent for spinning by rollers. In 1771, he built a second factory, at Cromford, in Derbyshire; this was turned by a water wheel after the manner of Messrs. Lombe's Silk Mill, at Derby. At this time the Jenny Spinners were earnestly employed in improving the machines used for carding and roving, and many ingenious contrivances were found out to shorten those operations. Mr. Arkwright kept an attentive eye on these contrivances, and by combining a number of them in a series of engines, he formed a complete system of carding and roving by machinery, for which he took out a second patent, dated December 16th, 1775. The improvements specified in this patent were not invented by Mr. Arkwright, but were borrowed by him from different spinners. These spinners, and others, continued to use these improvements after the patent was obtained, and in 1781 Mr. Arkwright commenced actions against a number of persons for invading his patent. Only one cause was tried, that against Col. Mordaunt, in the Court of King's Bench, in July, 1781. Col. Mordaunt's defence was, that Mr. Arkwright had not fully communicated his inventions in the specification, as required by law, and that therefore the patent was invalid. Several witnesses proved to the satisfaction of the Judge and Jury, that instead of disclosing his inventions in the specification, he had described them in a confused and unintelligible manner, and a verdict was given against Mr. Arkwright. Soon after this trial Mr. Arkwright published "The Case;" the following are extracts from it.

It begins by stating that Great Britain, from its many natural advantages, is particularly well adapted for a manufacturing country; that the extension of the cotton manufacture depends principally on the being able to spin cheaply and expeditiously, and after mentioning that many unsuccessful attempts had been made to spin by machines, it goes on as follows:—"About the year 1767, one Hargrave, of Blackburn, in Lancashire, constructed an engine that would at once spin twenty or thirty threads of cotton into yarn for the fustian manufacture; but because it was likely to answer in some measure the end proposed, his engines were burnt and destroyed, and himself driven out of Lancashire: he afterwards removed to Nottingham, and obtained a patent for his engine; but he did not even there long continue in the peaceable possession. His patent right was

“invaded, and he found it necessary to commence a prosecution; an association
 “was soon formed against him; and, being unable to contend against the united
 “power of a body of men, he was obliged to give up the unjust and unequal
 “contest. His invention was cruelly wrested from him; and he died in obscu-
 “rity, and great distress.”

“Mr. Arkwright, after many years intense and painful application, invented,
 “about the year 1768, his present method of spinning cotton, but upon very dif-
 “ferent principles from any invention that had gone before it. He was himself
 “a native of Lancashire; but having so recently witnessed the ungenerous treat-
 “ment of poor Hargrave, by the people of that county, he retired to Notting-
 “ham, and obtained a patent in the year 1769, for making cotton, flax, and
 “wool into yarn. But, after some experience, finding that the common method
 “of preparing the materials for spinning (which is essentially necessary to the
 “perfection of good yarn) was very imperfect, tedious, and expensive, he
 “turned his thoughts towards the construction of engines for that purpose;
 “and, in the pursuit, spent several years of intense study and labour, and at
 “last produced an invention for carding and preparing the materials, founded in
 “some measure on the principles of his first machine. These inventions, united,
 “completed his great original plan. But his last machines being very compli-
 “cated, and containing some things materially different in their construction,
 “and some others materially different in their use, from the inventions for which
 “his first patent was obtained, he procured a patent for these also in December,
 “1775.”

“No sooner were the merits of Mr. Arkwright’s inventions fully under-
 “stood, from the great increase of materials produced in a given time, and the
 “superior quality of the goods manufactured; no sooner was it known, that his
 “assiduity and great mechanical abilities were rewarded with success; than the
 “very men, who had before treated him with contempt and derision, began to
 “devise means to rob him of his inventions, and profit by his ingenuity. Every
 “attempt that cunning could suggest for this purpose was made; by the seduc-
 “tion of his servants and workmen, (whom he had with great labour taught
 “the business) a knowledge of his machinery and inventions was fully gained.
 “From that time many persons began to pilfer something from him; and then by
 “adding something else of their own, and by calling similar productions and
 “machines by other names, they hoped to screen themselves from punishment.
 “So many of these artful and designing individuals had at length infringed on

“his patent right, that he found it necessary to prosecute several: but it was not without great difficulty, and considerable expence, that he was able to make any proof against them; conscious that their conduct was unjustifiable, their proceedings were conducted with the utmost caution and secresy. Many of the persons employed by them were sworn to secresy, and their buildings and work-shops were kept locked up, or otherwise secured. This necessary proceeding of Mr. Arkwright, occasioned, as in the case of poor Hargrave, an association against him, of the very persons whom he had served and obliged. Formidable, however, as it was, Mr. Arkwright persevered, trusting that he should obtain in the event, that satisfaction which he appeared to be justly entitled to.

“A trial in Westminster Hall, in July last, at a large expence, was the consequence; when, solely by not describing so fully and accurately the nature of his last complex machines as was strictly by law required, a verdict was found against him. Had he been at all aware of the consequences of such omission, he certainly would have been more careful and circumspect in his description. It cannot be supposed that he meant a fraud on his country: it is on the contrary, most evident that he was anxiously desirous of preserving to his native country the full benefit of his inventions. Yet he cannot but lament, that the advantages resulting from his own exertion and abilities alone, should be wrested from him by those who have no pretension to merit; that they should be permitted to rob him of his inventions before the expiration of the reasonable period of fourteen years, merely because he has unfortunately omitted to point out all the minutiae of his complicated machines.” “In short, Mr. Arkwright has chosen a subject in manufactures (that of spinning) of all others the most general, the most interesting, and the most difficult. He has, after near twenty years unparalleled diligence and application, by the force of natural genius, and an unbounded invention, (excellencies seldom united) brought to perfection machines on principles as new in theory, as they are regular and perfect in practice. He has induced men of property to engage with him to a large amount; from his important inventions united, he has produced better goods, of their different kinds, than were ever before produced in this country; and finally, he has established a business that already employs upwards of five thousand persons, and a capital, on the whole, of not less than £200,000, a business of the utmost importance and benefit to this kingdom.”

The object of this “Case” was to obtain from the Legislature an act of Parliament to guarantee to Mr. Arkwright the patent-right which had been

invalidated and destroyed by the trial in 1781. In this "Case," and the knowledge of the circumstances attending it, the real character of Mr. Arkwright is better shewn than in volumes. The attributing of the invention of the Jenny to Hargrave, who was only an improver of it, and the cautious circumspection shewn in omitting to mention Highs, who had produced entire and perfect, Mr. Arkwright's great possession, the Rollers, or Water Frame, was artful in the extreme. Hargrave was then dead, and could make no claim, nor interfere in anywise with Mr. Arkwright's projects; but it was highly-important to Mr. Arkwright to keep Highs as much as possible in the back ground, and out of sight. The pathetic description of Hargrave's Engines being burnt and himself driven out of Lancashire, was intended to melt the hearts of the members of Parliament. This Mr. Arkwright might as well have done by giving them an extract from *Clarissa Harlowe*—her woes and those of Hargrave being about equally founded in fact. But in representing these misfortunes as having happened to Hargrave, and by shewing that he himself had also left Lancashire, and that both were labourers in the same vineyard, Arkwright was raising an interest for himself in the minds of the members, out of Hargrave's misfortune.

In this "Case," Mr. Arkwright, with all the assurance imaginable, roundly asserts that he invented the Water Frame, or Roller Spinning, in 1768—what effrontery!—Mr. Arkwright was NOT the inventor, as is demonstrable from the documents in the Appendix. His "great mechanical abilities" consisted solely in having cunning enough to pump a secret out of a silly, loquacious clock-maker, and in having sense enough to know when he saw a good invention. When we read in Mr. Arkwright's Case of "his inventions and his machinery "being pilfered from him by artful and designing individuals," we cannot help feeling sorry for him; but when we find that "his inventions" were all pirated from others, and that one of them (the crank and comb) "was cruelly wrested "from *poor Hargrave*," or, in other words, stolen from the man whose hard case he so feelingly deploras, we see the true bent of Mr. Arkwright's "natural genius "and unbounded invention," and feel emotions of a very different description from those he wished to excite. When Mr. Arkwright complains that "by the "seduction of his servants and workmen, a knowledge of his machinery was gained," we are forcibly reminded of the manner in which he procured the model of Highs' Water Frame; and when he says, "the persons employed by "the artful and designing individuals were sworn to secrecy," he brings to our recollection the bond he himself took from Kay.

In February, 1785, nearly four years after the first trial which overturned the patent, a second action was tried in the Court of Common Pleas, in which Mr. Arkwright brought a number of artists to prove that they could make machines from his specification, in consequence of which he obtained a verdict. In June, 1785, that is to say four months after the second trial, in consequence of the conflicting verdicts given in the two preceding trials, and as a great and final setting at rest of the dispute, a process on Scire-facias was brought against Mr. Arkwright in the Court of King's Bench, in which the whole question was brought to issue, not only on the point of the unintelligibility of his specification, but on the less technical and more important ground of not being himself the inventor of the machines for which he had obtained the patent. The ablest Counsel of the time, amongst whom were Mr. Bearcroft, Mr. Serjeant Adair, Baron Wood, the late Mr. Justice Chambre, and Lord Erskine, were arrayed on each side. After a long, minute, and ably-conducted trial, in which the first artists of the time, and also Hargrave's widow and son, Kay and his wife, and Highs himself, were examined, and models of the machines produced and worked in open Court before the Judge and Jury, a verdict was given against Mr. Arkwright, which upon a subsequent motion for a new trial, was held to be perfectly satisfactory by the Court; Mr. Justice Buller, before whom the cause was tried, expressing his opinion that Mr. Arkwright had not a leg to stand upon.

On this last trial it appeared that Mr. Arkwright's specification, dated Dec. 1775, contained ten articles. No. 1. A hammer worked by a cog wheel. On the trial, this was proved to have been described and engraved in Emmer-son's *Mechanics*, in 1773, and moreover, that if any person after the expiration of the patent had attempted to improve his machinery by following the directions given in the specification, he would have gained a loss, to use an Irish phrase, as this article would have utterly spoiled the cotton. No. 2. The witnesses could not tell what this was intended for, one of them, Mr. Samuel Moore, said he believed it was first used together with No. 1, for beating hemp, by Mr. Mc Pharson, and another, Benjamin Pearson, who had worked in Mr. Arkwright's factory seven years after he obtained the patent, deposed that he had never seen it or even heard of it. This useless article only served to render the specification unintelligible. No. 3. The Feeder of the Carding Engine, or cloth which conveys the cotton to the cylinder covered with cards. Henry Marsland proved that he used this Feeder in 1771, and that in 1771 or 1772, Mr. Ark-

wright called at his works and saw it, and John Lees proved that he invented a similar feeder in 1772. In the specification this article was described in a very obscure and confused manner. No. 4. The Crank for taking the carded cotton off the cylinder. This was proved, by Hargrave's Widow and Son, and by George Whitaker and others, to have been invented by James Hargrave, in 1772. No. 5. Filleted Cards on the second cylinder. These were nailed round the cylinder circularly, and took the carded cotton from the first cylinder in one continued fleece. Mr. Pilkington and Mr. Wood proved that these were invented by Mr. Wood, in 1774. No. 6. Two pairs of Rollers, one pair revolving faster than the other. These were proved by John Kay, his Wife, and Thomas Highs, to have been invented by the latter at Leigh, in 1767. See Appendix, Nos. 3, 4 and 5. No. 7. The Roving Can. Benjamin Butler proved that he used this article in 1759, and Betty Kennion and Joseph Woolley, proved that it was used in Mr. Binyon's factory, in 1773, or early in 1774. No. 8. The witnesses could not explain for what use this article was intended, and Mr. Arkwright's Counsel admitted that it was not used for preparing cotton, nor for spinning. No. 9. The Spindle used by Thomas Highs in the Water Frame, in 1767, and previously used in the Flax or Treddle Wheel. No. 10. None of the witnesses described the use of this article; it is a Shaft or Spindle, on which is a pulley and drum, which by strings give motion to the spindles, or to the roving can.

There never was a greater practical attempt made to mystify a subject since the creation of the world, than this specification of Mr. Arkwright's. He wished to have all the benefit of a patent as long as the law allowed him, and when that time was expired, he wished his specification to be such a stumbling block and inexplicable enigma to the public, that no one but himself should be able to make the machines. This is evident from his own admission to Mr. W. D. Crofts, who was examined on the trial, and then proved, that he was employed by Mr. Arkwright to draw out the specification, and that Mr. Arkwright told him he wished it to operate "as a specification, but to be as obscure as the nature of the case would possibly admit." From the evidence it appears, that the component parts of Mr. Arkwright's machines were all borrowed by him from other persons. When he saw an improvement in the Carding Engine or Roving Frame, he adopted it, and in the end, by combining Lees' Feeder, Wood's Filleted Cylinder, "Poor Hargrave's" Crank, Highs' Water Frame, and Butler's Roving Can, he completed a series of machines for carding and roving. He was enabled to do this the more easily by having the command of a large capital. The

inventors of the improvements had not the means of carrying them into effect on an extensive scale; they found the game, but from the want of capital were unable to secure it, whilst Mr. Arkwright, by availing himself of their inventions, and by inducing "men of property to engage with him to a large amount," reaped all the advantages and obtained all the rewards. That Mr. Arkwright deserves well of his country, and that he was one great means of forwarding her manufactures, is not meant to be denied. To combine, to arrange, to put in execution, though secondary to the merits of original invention, are, nevertheless, necessary to the perfection of art. Without Mr. Arkwright, the Water Frame would probably have had a slow and tedious introduction, or might have perished with its author and been lost to the world.

On the attempted assassination of his late Majesty, by Margaret Nicholson, Mr. Arkwright presented an address from the Hundred of Wirksworth, and was knighted; from which circumstance he was, by some, quaintly called "one of Peg Nicholson's knights." The following year, 1787, he was High Sheriff of Derbyshire.

Sir Richard Arkwright died at Cromford, in Derbyshire, in August, 1792, aged 59, and his life and labours are a worthy subject of contemplation. From a very low situation in life, he raised himself to the highest dignity in an extensive and affluent county—what a contrast does his splendid career present to that of Higs—and how melancholy the reflection, that the founder of Sir Richard's greatness partook not of his prosperity. While Sir Richard was filling the situation of the King's representative, escorting his Judges, and receiving favours from the Royal hand—Higs continued to make reeds. While gold was flowing in copious streams into the coffers of Sir Richard—Higs was struggling for the pittance of a day labourer. The latter was a man of a serious turn of mind and retired habits; sober, intelligent, and unassuming. He was universally respected and esteemed, and is even now well remembered in Leigh as a kind and benevolent man.

CHAPTER VIII.

Mis-statements of the foregoing Facts.

The misrepresentations of the above facts, by various writers, are so great, that it is frequently difficult to discover the spark of truth, through the misty and uncertain atmosphere which surrounds it, or to know whether we see a beacon or an ignis-fatuus.

The General Biography by Aikin and Enfield, 4to. London, 1799, vol. 1st. p. 392, says, that Hargrave invented the Jenny, in 1767. This is erroneous, as has been sufficiently shewn.

Aikin's History of Manchester, 4to. London, 1795, pages 170 and 171, says, that Arkwright obtained a patent for the Twist Machine and afterwards sued several cotton spinners for an invasion of his patent; that they joined issue with him, and that, in the event, he was non-suited. That Arkwright finding several improvements not in his first specification, got it extended, and specified in particular the invention of the Crank and Comb. That on the extension of the patent, care being taken to specify the additional improvements, he instituted another suit for the invasion of his patent, and obtained a verdict in the Court of Common Pleas. That the persons concerned got the matter removed in the Court of King's Bench, where, upon trial, it was proved that the Crank and Comb was a prior invention of an ingenious mechanic, Mr. Heyes by name. This account is equally incorrect with the former one given by Aikin and Enfield; there was no extension whatever of the patent after the trial in 1781, when Arkwright was non-suited, and it is apparent from the preceding pages that the Crank and Comb were invented by Hargrave and not by Highs, who had sufficient merit of his own to enable him to dispense with usurping the discoveries of others.

The Supplement to the Encyclopædia Britannica, 4to. article, Cotton Manufacture, page 392, states that Mr. John Kay, of Bury, invented the Fly Shuttle.

about 1762. In page 393 it is said that Hargrave invented the Jenny in 1767, and in page 394, that Arkwright's patent was contested in 1772.

Rees' Cyclopædia, 4to. London, 1819, vol. 10th. article, Cotton Manufacture, states that Hargrave invented the Jenny in 1767; that Higs invented the Crank and Comb, and that Arkwright's patent was contested about the year 1772.

Lempriere's Universal Biography, 4to. London, 1808, article, Arkwright, says that Arkwright invented the Jenny.

The Gentleman's Magazine, for August 1792, page 771, says that Arkwright acquired his wealth by accidentally purchasing a piece of Mechanism, called the Spinning Jenny, the invention of an ingenious carpenter. And in the following month, (page 863,) that Arkwright was a Barber, at Wirksworth, in Derbyshire, and by frequent opportunities of examining the silk mills at Derby, acquired the invention of the cotton mills.

It is a melancholy reflection, that on matters of such general notoriety, and which have happened within the memory of the present generation, so much incorrectness and misrepresentation should exist. They forcibly remind us of Sir Walter Raleigh's mortified feelings as to the uncertainty of History, when having witnessed an assassination from his window, while writing his History of the World, a number of witnesses swore directly contrary to the facts he had seen with his own eyes. And of Louis the 14th's remark to his officers when giving him accounts of a battle totally at variance with each other—"voila ce que l'histoire."

It may be proper to mention, that the account of the inventions of the Fly Shuttle and the Drop Box, given in the second chapter, is derived from a manuscript lent to me by Mr. Samuel Kay, of Bury, son of Mr. Robert Kay, the inventor of the Drop Box, and grandson of Mr. John Kay, the inventor of the Fly Shuttle. And that the orthography of Higs' name is taken from the Register of his marriage in Leigh Church.

CHAPTER IX.

Invention of the Mule and Exportation of Twist.

In the year 1780, there were twenty Water Frame factories, the property of Mr. Arkwright, or of persons who had paid him a consideration for permission to use his machines. After the repeal of the patent in 1785, the number of factories rapidly increased, and in 1790, there were one hundred and fifty in England and Wales. About 1790, factories were also built for the Jenny; in these factories the cotton was carded and roved by the newly-invented machines, which furnished weft better in quality and lower in price, than that spun on the smaller Jennies in the houses of the weavers. Carding, roving and spinning were now given up in the cottages, and the women and children formerly employed in those operations, applied themselves to the Loom. The invention of the Mule, by enabling spinners to make finer yarns than any the Jenny and Water Frame could produce, gave birth to the muslin manufacture, and found employment for this additional number of weavers.

The Mule is a compound of the Jenny and the Water Frame, from which circumstance it derives its name, and was invented in 1775, by Samuel Crompton, of Bolton-le-Moors. In this machine, the roving passes from the back part through rollers to the spindles, which are placed in front on a moveable frame. As the spindles revolve, this frame recedes from the rollers, somewhat faster than they give out the roving. The first pair of rollers draw the roving from the bobbin, the second pair draw it out and lengthen it, as in the Water Frame, and the pull of the spindles as the frame recedes, stretches it still finer. When a certain quantity of roving is given out, the rollers stop and shut fast the roving, as the clove does in the Jenny, the spindles still continuing to revolve and the frame to recede, drawing out the roving to the fineness required and giving it the necessary twist, the yarn is then wound upon the spindles by returning the

frame to its first position. See plate 12. By this gradual extension of the roving it can be drawn much finer than on the Jenny, or Water Frame, which stretch it out at one operation. The Mule was for some years after its invention used only in the dwelling-houses of the spinners, and had, like other inventions, to contend with much prejudice. As an instance of which, it may be mentioned, that when a young man, then a Fustian Master, but now a Magistrate in a populous part of Lancashire, established a factory, his father expressed his apprehension that his son Richard and his Mules, would all turn out Asses.

In 1790, the Mule was introduced into factories, and about the same time the Steam Engine began to be applied to the turning of machinery.

By these improvements in spinning the price of yarn was so much reduced, that the manufacturers were enabled to undersell their continental rivals, and at the same time could afford to remunerate the weaver with wages of thirty shillings per week. This was the case more particularly in the muslin manufacture.

The twist and weft spun on the Water Frame and the Jenny are coarse, and are chiefly used for strong goods, for thicksetts, velveteens, fancy cords and calicoes. These goods were also manufactured in France, Saxony and Switzerland, from yarn spun on the hand wheel, the low price of labour in those countries, in some measure counterbalancing the advantages the English derived from their improvements in spinning; but in the manufacture of fine Muslins, the English had not a rival in Europe. The French, Saxons and Swiss, could not spin the yarns for fine muslins on the hand wheel, and for some years, the English had this manufacture entirely to themselves. The continental manufacturers, however, soon procured fine yarns from England, and, with the aid of those yarns, they were enabled to rival the English in manufactured goods. By exporting mule yarn, the English have nourished and supported a foreign cotton manufacture, equal in extent to three fifths of their own, and have materially injured the interests of their own weavers. On the Continent, the necessaries of life are cheaper than in England, and the wages of the weavers very low, consequently, whilst foreign weavers are supplied with the same description of yarns the English manufacturer uses, obtained at the same price as that which he pays for them, he is compelled to reduce the wages of his own weavers to the foreign standard, in order to avoid being undersold in the market.

The machinery of England, particularly in the instance of the Mule, has thus been auxiliary to the prosperity of foreign, and, generally, hostile nations.

It has created resources of revenue for their treasuries, and a population to supply their armies, and, at the same time, has proportionably impoverished and injured its own. That this is not an exaggerated picture, will be evident from the following extracts from Parliamentary returns of the quantity of twist exported:—

In 1816,.....	16,362,782 lbs. were exported.
1818,.....	16,106,000
1819,.....	19,652,000
1820,	23,900,000
1821,..	23,200,000
1822*.....	28,000,000

The twist and weft spun in Great Britain in the year 1820, may fairly be estimated at	-	-	-	} 110,000,000 ^{lbs.}
The twist exported from Great Britain in the year 1820, according to Parliamentary returns amounted to	-	-	-	} 23,900,000
				86,100,000
The lace, thread and stocking manufactures use annually				7,000,000
				<hr/>
Manufactured into cloth in Great Britain in 1820.				79,100,000

One half of the seventy-nine millions manufactured in Great Britain, was twist for the warp, the other half was weft. Thus, for the sake of round numbers, we may say, that in 1820, Great Britain manufactured forty millions of lbs. of twist, and exported twenty-four millions. The export of twist being as three, and its home consumption as five, it follows, that to every five cotton weavers employed in Great Britain, there are three foreign weavers supplied with twist for their warps by our exports. The foreign manufacturers in general spin their own weft. The number of cotton weavers in Great Britain cannot be less than three hundred and sixty thousand, and with their families, they are probably half a million. The whole number of persons employed in Great Britain in spinning for the foreign weavers in the year 1822, taking the export at twenty-eight millions of lbs. could not exceed thirty-one thousand, of which number twenty thousand were children, and the twenty-eight millions of lbs. of twist

* The statement for 1822, in which it will be observed there is a considerable increase, is an estimate formed by competent judges, as well as circumstances will admit, the Officers of the Customs at Hull, not being willing to give the requisite information as regards that port.

spun by them, furnished twelve months supply of warps for upwards of two hundred and fifty thousand of foreign weavers.

The individuals in Great Britain interested in the export of twist, and benefited by that export, are as thirty-one, and with their families are as forty-six, the operative weavers in Great Britain, with their families, injured by that export, are as five hundred—what an astounding difference!—the interests of five hundred thousand people sacrificed to those of forty-six thousand! It is not fashionable at the present day to advocate what are called restrictions upon trade—but the facts speak for themselves; we have been nourishing in our bosom a serpent which may sting us—nay, which *is* stinging us—and the folly of our Government, in permitting mule twist to be exported duty free, to countries where the value of labour is so much lower than in England, is almost unequalled—perhaps the conduct of the Dutch, who in 1671 supplied Louis the 14th. with powder and ball to shoot themselves, is the only extant parallel case.

The old doctrine of Government, divine right and passive obedience, has by the progress of civilization and the diffusion of knowledge become obsolete, and the light now beginning to dawn upon the world, is, that the true object and end of governments are the protection and happiness of subjects. This doctrine has received the sanction of his present Majesty, who, on a memorable occasion, stated his conviction, that the Crown was held in trust for the benefit of the people. In this point of view, therefore, the Government of this country was guilty of a great dereliction of duty, and of a disregard of the interests of its most industrious subjects, in not imposing such a seasonable and proper impost on the exportation of cotton twist, as to have left the population of foreign countries to struggle with difficulties at least equal to those which our own have had to contend with. The evil of creating a colony of foreign weavers by the unrestricted exportation of our own fine twist, must have been evident to all, and the bad consequences which it has caused, as well as those which may ensue, (and from the above details of the exportation of mule twist they are evidently considerable and increasing) are, on the score of neglect, justly chargeable to the Government of this country.

English twist was first exported in small quantities about the year 1790. At that time the continental weavers were chiefly employed in the manufacturing of linen and woollen cloth, and the English, by their improvements in spinning, possessed almost a monopoly of the cotton manufacture. The Continent, if left to itself, would not have attempted to vie with us in the article of cotton, and what-

ever may be said as to the high price of a manufacture in a particular quarter having a tendency to make the means of producing it emigrate from the soil of its birth, it is plain, that from the want of machine-makers, of trained and experienced workmen, of capital and of fuel, in foreign countries, a restrictive impost in the outset would have preserved to us those advantages which are now enjoyed by foreigners. Improvements in machinery and skill in the operative workmen are progressive, and in 1790 we were in both so far advanced beyond all the continental nations put together, as to leave them scarcely the chance of success if they had attempted to rival us. By means of their agents sent over for the purchasing of twist, they have now acquired a knowledge of our machinery, and have many spinning factories; these are chiefly employed in making weft. The twist for their warps, which requires better machinery, and greater nicety and skill in spinning than weft, is supplied by the English.

Under the dynasty of Buonaparte, the Continent was shut against us, and the quantity of twist exported from England was but small. When he was sent to Elba, in 1814, the Continent was thrown open, twist was exported without restriction, and, in succeeding years, in increased quantities. What followed? A reduction of the wages of our weavers,* and its constant attendant, an increase of our Poor Rates.

If the Government of this country had paid proper attention to this subject, when twist was first exported, or in 1814, when the Continent was thrown open, great numbers of Weavers would have been kept off the Poor Rates, and probably much of the misery, tumultuous assemblages and riots, which took place in 1819, would have been prevented.

* Prices paid for Weaving 6-4ters. 60 Cambries, 24 yards, 160 picks in an inch.

				<i>s.</i>	<i>d.</i>					<i>s.</i>	<i>d.</i>			
1800	-	-	-	31	6	1811	-	-	-	-	16	0		
1801	-	-	-	30	0	1812	-	-	-	-	18	0		
1802	-	-	-	32	6	1813	{	June	-	-	-	21	0	
1803	{	June	-	-	34		6	{	November	-	-	-	27	0
	{	December	-	-	28	0	{	December	-	-	-	32	6	
1804	-	-	-	26	0	1814	{	June	-	-	-	28	0	
1805	{	January	-	-	28		0	{	December	-	-	-	20	0
	{	August	-	-	32	0	1815	-	-	-	-	17	0	
1806	{	January	-	-	30	0	1816	{	January	-	-	-	17	0
	{	June	-	-	27	0		{	June	-	-	-	14	0
1807	{	December	-	-	26	0	1817	-	-	-	-	14	0	
	{	April	-	-	22	0	1818	-	-	-	-	14	0	
1808	{	December	-	-	18	0	1819	-	-	-	-	12	0	
	-	-	-	-	18	0	1820	-	-	-	-	12	0	
1809	{	February	-	-	18	0	1821	-	-	-	-	13	6	
	{	June	-	-	20	0	1822	-	-	-	-	12	0	
1810	{	March	-	-	25	0	To weave one of these pieces would occupy a weaver about a week.							
	{	December	-	-	19	0								

From the above Table it will appear, that ever since the years 1815 and 1816, when the Continent was opened for the reception of British Twist, the Wages of the English Weaver have gradually declined.

CHAPTER X.

Change of Character and Manners, in the Population, superinduced by the extension of the Cotton Manufacture.

The population of Lancashire, before the introduction of the Cotton Manufacture, was chiefly Agricultural, and a favourable picture of its state may be found in Addison's character of Sir Roger de Coverley. In those days, the Squire was the feudal Lord of the neighbourhood, and his residence, or the Hall, as it was called, was looked upon in the light of a palace. He was the dictator of opinion, the regulator of parish affairs, and the exclusive settler of all disputes. On holidays the rustics were invited to the Hall, where they wrestled, ran races, played at quoits and drank ale. An invitation to the Hall was a certificate of good character; not to be invited along with his neighbours was a reproach to a man; because no one was uninvited unless he had been guilty of some impropriety. The Clergyman had scarcely less influence than the Squire, his sacred character and his superior attainments gave him great authority; he was generally from Oxford, and in those days the appellation of Oxford Scholar was understood to describe a man of learning and piety. He never met the elders of his flock without the kindest enquiries after the welfare of their families, and, as his reproof was dreaded, so his commendation was sought, by young and old. Incontinence in man or woman was esteemed a heinous offence, and neglecting or refusing to pay a just debt was scarcely ever heard of. Twice at Church on Sundays, a strict observance of fast days, and a regular reading of the Scriptures every Sunday evening, at which the youngsters, after putting off their best clothes, were always present, were uniform and established customs. The events of the neighbourhood flowed in a regular, unbroken train; politics were a field little entered into, and the histories of each other's families, including cousins five times removed, with marriages, births, deaths, &c. formed the almost only subjects of their conversations.

The Farmer was content to take on trust the old modes of husbandry and

management practised by his forefathers for generations; and new improvements were received, or rather viewed, with dislike and contempt. There was little fluctuation in prices, little competition between individuals, and the mind became contracted from this general stagnation and its being so seldom roused to exertion. Men being mostly employed alone, or having few but their own families to converse with, had not their understandings rubbed bright by contact and an interchange of ideas; they witnessed a monotonous scene of life which communicated a corresponding dulness and mechanical action to their minds. The greatest varieties of scene which they witnessed were the market day of the village, and the attendance at Church on the Sabbath, and the *summum bonum* of their lives was to sit vacant and inactive in each other's houses, to sun themselves in the market place, or to talk over news at that great mart of village gossip, the blacksmith's shop.

It is obvious that the morals of the people would, in a great measure, take their tone from the character of the Squire. In one particular neighbourhood, where fifty years ago the Squire was a man of superior understanding, expanded mind, amiable disposition, diffusive benevolence, and of the most pure and spotless integrity, the good effects of his residence among his tenantry were pre-eminently conspicuous.

The progress of the Cotton Manufacture introduced great changes in the manners and habits of the people. The operative workmen being thrown together in great numbers, had their faculties sharpened and improved by constant communication. Conversation wandered over a variety of topics not before essayed; the questions of Peace and War, which interested them importantly, inasmuch as they might produce a rise or fall of wages, became highly interesting, and this brought them into the vast field of politics and discussions on the character of their Government, and the men who composed it. They took a greater interest in the defeats and victories of their country's arms, and from being only a few degrees above their cattle in the scale of intellect, they became Political Citizens.

To these changes the establishing of Sunday Schools has very much contributed; they have been a great means of forwarding this wonderful alteration.*

* Sunday Schools were first established at Gloucester, by Mr. Robert Raikes, in 1780. In 1783, Mr. Raikes published an account of the good effects arising from his schools. This account met the eye of John Battersby, of Bedford, near Leigh, about Christmas, 1783. Mr. Battersby prevailed on some of his neighbours to join him in purchasing books, seats, and desks, and on the 28th of March, 1784, he opened a Sunday School at Green-lane-end, in Bedford. In the management of this school he was assisted by his brother Richard Battersby. These are the earliest instances of the establishment of those schools, which have now become general in every village and hamlet in the kingdom, and which exercise so decided an influence on the minds and character of the rising generation.

Before their institution the lower orders were extremely illiterate; very few of them could read, and still fewer could write, and when one of them learned to read, write and cast accounts, those acquirements elevated him to a superior rank. His clerical skill exempted him from manual labour, and as a shopman, book-keeper or town's officer—perchance in the higher dignity of parish clerk or school-master—he rose a step above his original situation in life.

The labourers and operative workmen were formerly sunk in the depths of ignorance; they seldom formed an opinion of their own, and were content to believe every thing their superiors told them. Sunday Schools have greatly assisted in dispelling this thick cloud of ignorance, they have taught the mass of the people to read, and the countless publications dispersed over the country, in monthly portions or numbers, at 6d., 9d. or 1s. per number, have taught them to reason and think for themselves. During the last 40 years the mind of the labouring class (taking them as a body) has been progressively improving, and within the last 20, has made an advance of centuries, and is still advancing with accelerated rapidity.

The facility with which the Weavers changed their masters, the constant effort to find out and obtain the largest remuneration for their labour, the excitement to ingenuity which the higher wages for fine manufactures and skilful workmanship produced, and a conviction that they depended mainly on their own exertions, produced in them that invaluable feeling, a spirit of freedom and independence, and that guarantee for good conduct and improvement of manners, a consciousness of the value of character and of their own weight and importance.

The practical truth of these remarks must be obvious to every one who has served on the Jury at Lancaster, and compared the bright, penetrating, shrewd and intelligent Jurors from the south of the county, with the stupidity and utter ignorance of those from its northern parts; and to every one who witnessed the fervour and enthusiasm with which the people in the manufacturing districts flew to arms, in 1803, to defend their firesides against a foreign invader. What crowding to the drills; what ardour and alacrity to learn the use of arms there then was, and how much stronger and more rapid the feeling of independence, both national and individual, is found to be among a highly-civilized dense manufacturing population, than among a scattered half-informed Peasantry!

The amusements of the people have changed with their character. The Athletic exercises of Quoits, Wrestling, Foot-ball, Prison-bars and Shooting with the Long-bow, are become obsolete and almost forgotten; and it is to be regretted that the present pursuits and pleasures of the labouring class are of a more effemi-

nate cast—They are now Pigeon-fanciers, Canary-breeders and Tulip-growers. The field sports, too, have assumed a less hardy and enterprising character. Instead of the Squire with his merry harriers and a score or two of ruddy, broad-chested yeomen, scouring the fields on foot heedless of thorn or briar, and scorning to turn aside for copse or ditch, we now see half a dozen Fustian Masters and Shopkeepers, with three or four greyhounds and as many beagles, attacking the poor Hare with such a superiority, both as respects scent and fleetness, as to give her no chance of escape, and pouncing upon their game like poachers, rather than pursuing it with the fairness and hardihood of hunters.

CHAPTER XI.

Moral and Religious Character of Weavers.

If we examine the history of the moral character of Weavers, we shall find them, from the earliest periods, distinguished by a propensity to scrutinize the received dogmas of the times, and, generally, foremost in the race of liberal opinions, zealous in supporting the promulgation of new doctrines, full of hostility to the encroachments of tyrannical power, disposed to fanaticism in religion, often of a gloomy and determined cast of character and pervaded with the most entire devotion to the cause they espouse, a circumstance to which the peculiarity of their religious feelings mainly contributes.

The doctrines of Luther were first sown and took root amongst the Weavers and manufacturing population of Saxony, a soil the most genial for the reception of the new religion, and posterity is indebted to them for having received and sheltered that vigorous controversialist, and for having nourished and fanned the spark which afterwards blazed out far and wide, enlightened the European mind and freed it from the chains of darkness and superstition. Amongst men less disposed to enquire and to question, and more inclined to bow to the dictates of authority, the nascent spark might have been extinguished. The Weavers in England, also, were among the earliest supporters of the Reformation, and were cruelly persecuted by Bonner.*

The new religion spread so fast amongst the mercantile and manufacturing population in the Netherlands, as to call down upon them the vengeance of the bigoted court of Spain, and in 1567 the Duke of Alva, a fit instrument for such a measure, was dispatched by Philip to execute it. More than one hundred thousand were expatriated by his barbarous cruelties. These exiles, the most indus-

* Burnet's History of the Reformation, folio, London, 1681, 2d. part, pages 307, 313.

trious of the people, (for it was chiefly by the manufacturers and merchants that the opinions of the Reformers were embraced,) fled to other countries, carrying with them their industry, their arts and their manufactures. Elizabeth supported and protected the Worsted Weavers who took shelter in England, and with her encouragement numbers of them settled at Norwich.

That a hundred thousand quiet, moral, industrious citizens should have been exiled, put to death, exterminated, for a speculative difference of opinion only, would excite in us unmixed indignation, but that we feel the Barbarian was by the same blow punishing himself. By exiling and destroying the manufacturing population he deprived himself of one of the best sources of wealth and political greatness, and transferred them to England, at that time his most formidable enemy, and the chief support of the religion he wished to extirpate. Haerlem, famous for its linen manufacture, made a most vigorous and desperate, but unsuccessful defence against Frederick, son of Alva, in 1572, and 1573.*

As the Weavers in England, in the commencement of the 16th century, had been among the foremost to receive and adopt Luther's doctrines, so we find them, in the commencement of the 17th. century, equally ready to receive those of Puritanism, and they encountered, perhaps in a slighter degree, persecutions from the English Hierarchy similar to those which their predecessors had sustained from the Roman Catholics. Great numbers of Woollen and Worsted Weavers were driven out of the country by the intolerant Laud, and they also met with much severe treatment from Wrenn, Bishop of Norwich. Some of them fled to Holland, others to the new settlement in Massachusetts' Bay.† Glasgow, where the Weavers were a corporate body in 1528, was early distinguished for its zeal against Popery, and, in the middle of the 17th century, was staunch in supporting the covenant. Full of gloom and fanaticism the Covenanters prohibited the most innocent amusements, and were prepared to hallow with texts of scripture every atrocity which political rancour could produce. After the battle of Kilsyth,

* Observations upon the United Provinces, by Sir Wm. Temple, 12mo. London, 1673, pages 33, 34, 203. History of Philip 2nd. by Robert Watson, LL. D. 7th edition, London, 1812, vol. 1st. pages 294, 298, 299, 300, 392; Vol. 2nd. page 64 to 89. History of Philip 3rd. by Robert Watson, LL. D. 3rd. edition, London, 1808, vol. 1st., page 245. Pinkerton's Voyages and Travels, 4to. London. 1808, vol. 2nd. pages 32, 33.

† Lives of James 1st., Charles 1st., Oliver Cromwell and Charles 2nd., by Wm. Harris, 8vo. London, 1814, vol 2nd. page 243. Select Tracts relating to the Civil Wars in England, in the reign of Charles 1st., by Francis Maseres. 8vo. London, 1815. part 1, page 163.

Montrose levied heavy contributions upon the City, as a punishment for its attachment to the Covenant.*

In the year 1640, Taunton, one of the chief manufacturing towns in the West of England, adopted and vigorously supported the cause of the parliament.†

The Inhabitants of Gloucester, in 1643, made a most determined resistance against Charles 1st. and, in all probability, prevented him from making a conquest of his kingdom. At that time Gloucester was famous for its manufacture of woollen cloth, and though the Gentlemen of the City were in favour of the King, the Tradesmen and Weavers were strongly hostile to him, and fought with surprising courage and resolution.

A cotemporary writer thus describes them: “The Inhabitants consisted chiefly of Yeomen, Farmers, Petty Freeholders, and such as use manufactures that enrich the country and passe through the hands of a multitude, a generation of men truely laborious, jealous of their properties, whose principall ayme is Liberty and Plenty, and whilst in an equal rank with their neighbours, they desire only not to be oppressed, and account themselves extreamly bound to the world if they may keepe their owne; such therefore continually thwart the intentions of tyrannie.”‡

When the Duke of Monmouth landed in the West, in 1685, the nobility and gentry of Somersetshire sided with James the 2nd. but the manufacturing towns of Taunton, Bridgewater and Froome joined the Duke.§

The free spirit which animated the Hugonots of France, and the consequent disgust with which Louis the 14th. regarded them, was, in all probability, the cause of the revocation of the Edict of Nantz. This measure drove fifty thousand Hugonot families from France; they were chiefly Weavers, and twenty thousand of them settled in Spital-fields, London, and gave a new impulse to the English silk manufacture.||

* History of Glasgow, by James Denholm, 12mo. 2nd. edition, Glasgow, 1798, pages 15, 20, 153.

† Clarendon's History of the Civil War, 8vo. Oxford, 1712, vol. 2nd. part 1st. page 275.

‡ Clarendon's History of the Civil War, 8vo. Oxford, 1712, vol. 2nd. part 1st. page 344. Historical Relation of the Military Government of Gloucester, by John Corbet, Preacher of God's Word, 12mo. London, 1645, pages 9, 17. History of Gloucestershire, folio, Cirencester, Printed by Samuel Rudder, 1779, pages 123, 124, 107 to 112. The Ancient and present state of Gloucestershire, by Sir Robert Atkyns, Knt. folio, second edition, London, 1712, reprinted 1768, page 46.

§ History of the early part of the Reign of James the Second, by the Right Hon. Charles James Fox, 4to. London, 1808, pages 229, 231, 234, 237.

|| Chalmer's Domestic Economy of Great Britain and Ireland, 8vo. Edinburgh, 1812, page 78. Modern London, 4to. London, 1804, page 134.

Londonderry, the capital of the manufacturing county of Derry, in Ireland, and itself a manufacturing City, after sustaining a siege of four months and enduring all the horrors of famine, courageously repulsed the army of James the 2d. and gave the first check to his successes.

In 1715, the Citizens of Glasgow raised a battalion of six hundred men to oppose the Pretender, and, in 1746, they raised two battalions of four hundred and fifty each, for the same purpose.

At the approach of the Pretender, in 1745, the conduct of Manchester would seem to form an exception to the general feeling of the other manufacturing districts, but it must be remembered, that the town was quite unprepared for resistance, and that the mass of the people was quiescent, not active. What has been represented as the conduct of the town generally, was merely that of a few individuals zealously attached to the Stuarts.

When Wesley and Whitfield unfurled the standard of Methodism, the Weavers flocked to it and shewed as much zeal and ardour in favour of the new Religion, as their predecessors had previously shewn at the Reformation, or in the succeeding period of Puritanism. The great mass of Weavers are now deeply imbued with the doctrines of Methodism, and form a great proportion of the whole number of persons who profess that religion. The belief in a preternatural mental communication with the spiritual world, and in instantaneous regeneration, and the enthusiastic singing of Hymns in full chorus, are strictly in unison with that religious character for which the Weavers have ever been distinguished.

CHAPTER XII.

The Steam Loom.

The same powerful agent which so materially forwarded and advanced the progress of the Cotton Manufacture in the concluding part of the last century, has lately been further used as a substitute for manual labour, and the Steam Engine is now applied to the working of the Loom as well as to the preparatory processes.

The first attempt to Weave by Machinery was made by M. De Gennes, about the year 1695. His Loom is described in "The Philosophical Transactions to the end of the year 1700," abridged by John Lowthorp, M. A. and F. R. S. 3d. edition, London, 1722, page 501. About 1765 a weaving factory, turned by water, was built by Mr. Garside, of Manchester. It was filled with Swivel Looms, probably those invented by M. Vauconson, and described in the *Encyclopedie Methodique*, and was worked for a considerable time but produced no advantage, one man being required to superintend each Loom.

In 1785, the Rev. E. Cartwright invented a Loom to be worked by water or steam. The following account of this invention is taken from the Supplement to the *Encyclopædia Britannica*:—"Happening to be at Matlock, in the summer of 1784, I fell in company with some gentlemen of Manchester, when the conversation turned on Arkwright's spinning machinery. One of the company observed, that as soon as Arkwright's patent expired, so many mills would be erected, and so much cotton spun, that hands never could be found to weave it. To this observation I replied that Arkwright must then set his wits to work to invent a weaving mill. This brought on a conversation on the subject, in which the Manchester gentlemen unanimously agreed that the thing was impracticable; and in defence of their opinion, they adduced arguments which I certainly was incompetent to answer or even to comprehend, being

“totally ignorant of the subject, having never at that time seen a person weave. I controverted, however, the impracticability of the thing, by remarking that there had lately been exhibited in London, an automaton figure, which played at chess. Now you will not assert, gentlemen, said I, that it is more difficult to construct a machine that shall weave, than one which shall make all the variety of moves which are required in that complicated game.

“Some little time afterwards, a particular circumstance recalling this conversation to my mind, it struck me, that, as in plain weaving, according to the conception I then had of the business, there could only be three movements, which were to follow each other in succession, there would be little difficulty in producing and repeating them. Full of these ideas, I immediately employed a carpenter and smith to carry them into effect. As soon as the machine was finished, I got a weaver to put in the warp, which was of such materials as sail cloth is usually made of. To my great delight, a piece of cloth, such as it was, was the produce.

“As I had never before turned my thoughts to any thing mechanical, either in theory or practice, nor had ever seen a loom at work, or knew any thing of its construction, you will readily suppose that my first Loom must have been a most rude piece of machinery.

“The warp was placed perpendicularly, the reed fell with a force of at least half an hundred weight, and the springs which threw the shuttle were strong enough to have thrown a Congreve rocket. In short, it required the strength of two powerful men to work the machine at a slow rate, and only for a short time. Conceiving in my great simplicity, that I had accomplished all that was required, I then secured what I thought a most valuable property, by a patent, 4th April, 1785. This being done, I then condescended to see how other people wove; and you will guess my astonishment, when I compared their easy modes of operation with mine. Availing myself, however, of what I then saw, I made a Loom in its general principles, nearly as they are now made. But it was not till the year 1787, that I completed my invention, when I took out my last weaving patent, August 1st, of that year.”

Mr. Cartwright erected a weaving mill at Doncaster, which he filled with Looms. This concern was unsuccessful, and at last was abandoned, and some years afterwards, upon an application from a number of manufacturers at Manchester, Parliament granted Mr. Cartwright a sum of money as a remuneration for his ingenuity and trouble.

About 1790, Mr. Grimshaw, of Manchester, under a licence from Mr. Cartwright, erected a weaving factory turned by a Steam Engine. The great loss of time experienced in dressing the warp, which was done in small portions as it unrolled from the beam, and other difficulties arising from the quality of the yarn then spun, were in this instance formidable obstacles to success; the factory, however, was burnt down before it could be fully ascertained whether the experiment would succeed or not, and for many years no further attempts were made in Lancashire to weave by steam.

Mr. Austin, of Glasgow, invented a similar Loom, in 1789, which he still further improved in 1798, and a building to contain two hundred of these Looms was erected by Mr. Monteith, of Pollockshaws, in 1800.

In the year 1803, Mr. Thomas Johnson, of Bradbury, in Cheshire, invented the Dressing Frame. Before this invention the warp was dressed in the Loom in small portions as it unrolled from the beam, the Loom ceasing to work during the operation. Mr. Johnson's machine dresses the whole warp at once; when dressed the warp is placed in the Loom which now works without intermission. A factory for Steam Looms was built in Manchester, in 1806. Soon afterwards two others were erected at Stockport, and about 1809, a fourth was completed in Westhoughton. In these renewed attempts to weave by steam, considerable improvements were made in the structure of the Looms, in the mode of warping, and in preparing the weft for the shuttle. With these improvements, aided by others in the art of spinning, which enabled the spinners to make yarn much superior to that made in 1790, and assisted by Johnson's machine, which is peculiarly adapted for the dressing of warps for Steam Looms, the experiment succeeded. Before the invention of the Dressing Frame, one Weaver was required to each Steam Loom, at present a boy or girl, fourteen or fifteen years of age, can manage two Steam Looms, and with their help can weave three and a half times as much cloth as the best hand Weaver. The best hand Weavers seldom produce a piece of uniform evenness; indeed, it is next to impossible for them to do so, because a weaker or stronger blow with the lathe immediately alters the thickness of the cloth, and after an interruption of some hours, the most experienced weaver finds it difficult to recommence with a blow of precisely the same force as the one with which he left off. In Steam Looms, the lathe gives a steady, certain blow, and when once regulated by the engineer, moves with the greatest precision from the beginning to the end of the piece. Cloth made by these Looms, when seen by those manufacturers who employ hand Weavers, at once excites admiration and a consciousness that their own workmen

cannot equal it. The increasing number of **Steam Looms** is a certain proof of their superiority over the **Hand Looms**. In 1818, there were in **Manchester, Stockport, Middleton, Hyde, Stayley Bridge**, and their vicinities, fourteen factories, containing about two thousand **Looms**. In 1821, there were in the same neighbourhoods thirty-two factories, containing five thousand seven hundred and thirty-two **Looms**. Since 1821, their number has still farther increased, and there are at present not less than ten thousand **Steam Looms** at work in **Great Britain**.

It is a curious circumstance, that, when the **Cotton Manufacture** was in its infancy, all the operations, from the dressing of the raw material to its being finally turned out in the state of cloth, were completed under the roof of the weaver's cottage. The course of improved manufacture which followed, was to spin the yarn in factories and to weave it in cottages. At the present time, when the manufacture has attained a mature growth, all the operations, with vastly increased means and more complex contrivances, are again performed in a single building. The **Weaver's cottage** with its rude apparatus of peg warping, hand cards, hand wheels, and imperfect looms, was the **Steam Loom factory** in miniature. Those vast brick edifices in the vicinity of all the great manufacturing towns in the south of **Lancashire**, towering to the height of seventy or eighty feet, which strike the attention and excite the curiosity of the traveller, now perform labours which formerly employed whole villages. In the **Steam Loom factories**, the cotton is carded, roved, spun, and woven into cloth, and the same quantum of labour is now performed in one of these structures which formerly occupied the industry of an entire district.

A very good **Hand Weaver**, a man twenty-five or thirty years of age, will weave two pieces of nine-eighths shirting per week, each twenty-four yards long, and containing one hundred and five shoots of weft in an inch, the reed of the cloth being a forty-four, **Bolton count**, and the warp and weft forty hanks to the pound. A **Steam Loom Weaver**, fifteen years of age, will in the same time weave seven similar pieces. A **Steam Loom factory** containing two hundred **Looms**, with the assistance of one hundred persons under twenty years of age, and of twenty-five men, will weave seven hundred pieces per week, of the length and quality before described. To manufacture one hundred similar pieces per week by the hand, it would be necessary to employ at least one hundred and twenty-five **Looms**, because many of the **Weavers** are females, and have cooking, washing, cleaning and various other duties to perform; others of them are chil-

dren and, consequently, unable to weave as much as the men. It requires a man of mature age and a very good Weaver to weave two of the pieces in a week, and there is also an allowance to be made for sickness and other incidents. Thus, eight hundred and seventy-five hand Looms would be required to produce the seven hundred pieces per week; and reckoning the weavers, with their children, and the aged and infirm belonging to them, at two and a half to each loom, it may very safely be said, that the work done in a Steam Factory containing two hundred Looms, would, if done by hand Weavers, find employment and support for a population of more than two thousand persons.

The Steam Looms are chiefly employed in Weaving printing cloth and shirtings; but they also weave thicksetts, fancy cords, dimities, cambrics and quiltings, together with silks, worsteds, and fine woollen or broad cloth. Invention is progressive, every improvement that is made is the foundation of another, and as the attention of hundreds of skilful mechanics and manufacturers is now turned to the improvement of the Steam Loom, it is probable that its application will become as general, and its efficiency as great, in Weaving, as the Jenny, Water Frame and Mule, are in Spinning, and that it will, in this country at least, entirely supersede the hand Loom. But, so great is the difference, so astonishing the disproportion, between the price of labour in India and in Europe, that when Mule Twist is exported from England to Hindostan, or when Mule factories are established there, the Indian hand Weavers will undersell the English Steam Loom manufacturers, that is to say, when the Indian Weaver can avail himself of the assistance of part of our machinery, he will be able to beat the other part out of the market. The race of competition betwixt the cheapness of labour in Hindostan and English industry assisted by machinery, is much nearer upon an equality than is generally supposed. The very trifling difference between India manufacture, as produced from yarn spun by the distaff and spindle, and that produced in England from yarn spun by machinery, is only as fourteen and a quarter to nineteen and a half; the Indian manufacturer being able to sell for one shilling and seven-pence half-penny, that which the English manufacturer, with all his machinery and economy of human labour, cannot afford to sell for less than one shilling and two-pence farthing. This immense disproportion of price, considering the multiplied facilities which the English manufacturer possesses in comparison with his Indian rival, ought to make us dread as the greatest evil that can possibly happen to the manufactures of England, the Establishment of Mule or other factories in Hindostan, where there is an overflowing

population, skilful in the management of the Loom and long trained to its labours, each individual of which usually subsists upon wages of three-pence per day.*

From the best accounts that can be obtained, the annual Consumption of Cotton in India is eight hundred thousand bags, while that in Great Britain is only six hundred thousand. There being no machinery used in India, it is manifest, that the spinning and manufacturing of such a vast quantity of cotton must give employment and support to immense numbers of people, and if English spun Twist and Weft is conveyed to them in a state ready for being woven into cloth, all those employed in the protracted and tedious process of spinning by the Distaff and Spindle, will be gradually thrown out of employment, the consequence of which must be that the hands and time employed in this process will be applied to the labours of the Loom, and the Indian population will become Weavers for the whole world.

*The following Statement of the prices of Spinning and Weaving in Hindostan, are taken from Mr. Lee's calculations, printed about the year 1811.

	s.	d.
Weaving a square yard of Cloth, containing thirteen hanks, of one hundred hanks Yarn.....	0	0½
Spinning the thirteen hanks of Yarn.....	1	7
	<hr/>	
Cost of the Cloth manufactured in India, from Indian spun Yarn	1	7½
	<hr/>	
The Weaving of a similar yard of Cloth in England, at the present rate of wages.....	0	7
Spinning the thirteen hanks in England, at the present prices of Yarn.....	0	7¼
	<hr/>	
Cost of the Cloth manufactured in England.....	1	2¼

If the Indian Manufacturer was supplied with English Yarn, he would be enabled to manufacture the same Cloth for eight-pence half-penny.

	s.	d.
The Yarn.....	0	7¼
Freight.....	0	0¼
Weaving.....	0	0½
	<hr/>	
	0 8½	

Whenever the great current of English Twist flows unrestrictedly into the Indian market, all the exertions to improve the Steam Loom will have become futile, and all the capital and machinery employed in working it, a ruinous speculation. The Indian Weaver will obtain our Twist, Weave it into Cloth, return it to England, and with all our boasted Machinery, all our Steam Looms and their subordinate preparatory machines, undersell us in our own Markets.

The Indian Weaver can support himself as just mentioned, with wages of three-pence per day, and when those vast hordes of population which the Asiatic countries alone exhibit, apply themselves to weaving Yarn spun by machinery, it is perfectly demonstrable, that the Weavers of Europe, whose wages are so disproportionate to those of India, must turn to some other employment, or starve, and which ever is the case the greatest distress and misery must ensue. Alarming as this prospect is, it does not admit of the alleviation of being a distant one, at this very time, perhaps, the first step to the innumerable evils which must fall upon the Weavers of England and of Europe has been made. **A QUANTITY OF TWIST WAS SHIPPED LAST YEAR TO INDIA FROM THE PORT OF LIVERPOOL, AND THE ADVENTURE HAS PROVED A HIGHLY SUCCESSFUL ONE.** The arguments which have been used to shew the impolicy of the exportation of Cotton Twist from England to the Continent of Europe, will no doubt be answered by an assertion that, were it now to be put a stop to, all that Twist which is exported and gives employment to the Continental Weavers, would stagnate in our own Markets, to the ruin and destruction of the whole spinning interest of England, and of the capital employed in it; but no such argument can be used on the subject of the exportation to India, because the practice is now first originating, and probably the shipment just alluded to is the first that ever sailed to India from the British shores. The distress and misery to which it may give rise by bringing the Indian into competition with the British Weaver appears so great, so pregnant with destruction to the latter, that, as one interested in the welfare of my country, and feeling an anxious and tender solicitude for the well being and prosperity of that industrious and intelligent population, the operative Weavers of this kingdom, I call earnestly upon that Legislature and those Statesmen, whose sacred trust it is to watch over and protect the interests of the people, to turn their most serious attention to a question so vitally important to their countrymen.

An account of the quantity (in lbs. net) of Cotton Wool imported into Great Britain from the year 1791, and at different intervals prior to that time. (Parliamentary returns, except the years 1813, 1820, 1821 and 1822):—

	<i>lbs.</i>		<i>lbs.</i>
From 1701 to 1705 average of 5 years	1,170,881	1804 - - - - -	61,867,329
1716 to 1720 - -	2,173,287	1805 - - - - -	59,682,406
About this time the Jenny and Water Frame were invented.		1806 - - - - -	58,176,283
1771 to 1775 - -	4,764,589	1807 - - - - -	74,925,306
1776 to 1780 - -	6,706,013	1808 - - - - -	43,605,982
1781 to 1785 - -	10,941,934	1809 - - - - -	92,812,282
Arkwright's patent repealed.		1810 - - - - -	136,488,935
1786 to 1790 - -	25,443,270	1811 - - - - -	91,576,535
1791 - -	28,706,675	1812 - - - - -	63,025,936
1792 - -	34,907,497	1813 - - - - -	50,966,000
1793 - -	19,040,929	1814 - - - - -	60,060,239
1794 - -	24,358,567	1815 - - - - -	99,306,343
1795 - -	26,401,340	The Continent opened for the reception of British Twist.	
1796 - -	32,126,357	1816 - - - - -	93,920,055
1797 - -	23,354,371	1817 - - - - -	124,912,968
1798 - -	31,860,641	1818 - - - - -	177,282,158
1799 - -	43,379,278	1819 - - - - -	149,739,820
1800 - -	56,010,732	1820 - - - about	143,897,000
1801 - -	56,004,305	1821 - - - - -	129,013,000
1802 - -	60,345,600	1822 - - - - -	142,202,000
1803 - -	53,812,284		

APPENDIX.

No. 1.

The Statement of Thomas Leather.

Thomas Leather, of Leigh, Weaver, aged sixty-nine, says, that when about eight years of age he came with his father Richard Leather, and his mother Betty Leather, from Padgate, to live in a house situated on the west side of a street in Leigh, called the Walk; that the said street is in the Township of Pennington, and Parish and Town of Leigh; that his father was a wheelwright; that when they had lived one year at the said house they removed to another house, a public-house, situated on the east side of the Walk; that the last-mentioned house is now occupied by Molly Aspinwall; that he lived with his father three years in this last-mentioned house, in the first of which years his mother died; that at the end of the three years his father and he quitted the house and never afterwards resided in it. That whilst he lived the three years with his father, in the house on the east side of the Walk, their next door neighbour on the south side was James Smetham, Glass-maker, and their next but one on the south side was Thomas Higs, Reed-maker; that their next door neighbour on the north side was John Kay, Clock-maker. That whilst he lived the three years with his father, in the house on the east side of the Walk, there was much talk amongst the neighbours about a Spinning Machine, that Higs and Kay were making in Higs' garret, that Higs and Kay worked at this machine during over hours, sometimes working until late at night; that after they had worked at it some months, they one Sunday Evening threw or carried it into the back yard and broke it. That on the Monday morning, he, this deponent, took a wheel or pulley for a trundle bowl from the broken machine as it lay in the yard; that when the neighbours heard that Higs and Kay had broken the machine they laughed at them; that Kay said he would have no more to do with Spinning machines; that Higs, however, was not satisfied, but took the broken machine

into his garret and soon after completed a Spinning Jenny. That the Jenny made by Highs had six spindles; that the spindles stood at the front of the Jenny, and were turned by strings from a drum working on a perpendicular axle; that the clove worked perpendicularly, rising when drawing out the weft, and falling when it was copped. That after Highs had invented this machine he did not work much at Reed-making, but was employed in making and scheming machines for Spinning; that Highs' daughter, Jenny, set the Reeds during her father's absence. That John Kay left Leigh, and went to live at Warrington about the time this deponent and his father removed from the house on the east side of the Walk, and that Thomas Highs and his family went to live in a house in Bradshaw-gate, in Leigh, about the same time.

THE MARK OF THOMAS ✕ LEATHER.

Signed by Thomas Leather after having been taken down in writing, from his own statement, and read over to him by Abraham Heyes, this twenty-ninth day of August, one thousand eight hundred and twenty-three,

In the presence of ABRAHAM HEYES,
SAMUEL WHITTLE, Parish Clerk.

No. 2.

Certificate of the Burial of Mary Leather, mother of Thomas Leather.

The following Certificate is copied from the Parish Register:—

“Burials at Leigh Church, continued. October 4th, 1763, Betty, wife of Richard Leather, of Pennington.”

Witness, SAMUEL WHITTLE, Parish Clerk.

Leigh, March 7th. 1822.

No. 3.

The Evidence of Thomas Highs, given in the Court of King's Bench, on the 25th Day of June, 1785, on a Trial of a cause instituted on a Writ of Scire Facias, to repeal a Patent granted to Mr. Richard Arkwright, 16th December, 1775. London, folio, 1785.

THOMAS HIGHS, Sworn. Examined by SERJEANT BOLTON.

Q. What business are you?

A. By trade I am a Reed-maker.

Q. Have you been employed to make machines for manufacturers?

A. I have.

Q. Look at this carding machine, with the two cylinders, the great one and the little one. Look at that—how long ago have you seen one of those?

A. It is about twelve years; between twelve and thirteen years.

Q. Was your little cylinder like that, covered over with needles?

A. Covered over with cards, it was.

Q. Do you happen to remember, Mr. Highs, telling Mr. Arkwright about this?

A. About this, Sir?

Q. Aye!

A. No, not about that.

Q. But about the machine that was made?

A. No, I did not tell him about that, it was made after I had some discourse with Mr. Arkwright.

Q. When was it you had that discourse with Arkwright?

A. It might be about thirteen years since, as near as I can guess, but cannot just remember every thing.

Mr. Serjeant Bolton.—I will take him to the rollers.—Look at the rollers through which the thread comes, the roving or spinning, or whatever it is called. Did you ever see rollers like those before 1775, before Mr. Arkwright's patent?

A. I have seen rollers; I made rollers myself in 1767.

Q. You yourself made rollers in 1767?

A. Yes, Sir.

Q. Have you looked at them; you see one is fluted, the other covered with leather?

A. I see it is.

Q. Was your's the same way?

A. Yes, mine was, two years after, but not then.

Q. Not at first?

A. No.

Q. In 1769 your's were like it?

A. They were, mine had fluted work; fluted wood, upon an iron axis; but the other roller was the same, only it was covered with shoe leather, instead of that leather; I am informed it is such as they make shoes of.

Q. Who did you employ when you first conceived this invention; who did you employ to make it for you?

A. I employed one Kay, who came from Warrington.

Q. What trade was he?

A. He followed clock-making, at that time.

Q. You employed him to make it?

A. Yes, I employed him to make a small model, with four wheels, of wood, to shew him the method it was to work in, and desired him, at the same time, to make me brass wheels, that would multiply it about five to one.

Q. Look at that, and see whether it is upon the same principle?

A. No, not exactly so; the wheels were not exactly so.

Q. Who made you the wheels?

A. I made them myself.

Q. Describe what you mean by multiplying five to one?

A. By making the different rollers go, one faster than the other.

Q. Was that for the purpose of drawing the thread finer.

A. Yes, Sir,

Mr. Erskine. It is very necessary your Lordship should take notice, the only description given by Mr. Arkwright, for his rollers, falls in directly with this man's description. All he says, is, "No. 6 consists of rollers fixed to a

“wooden frame, the contents of No. 5 being brought to it, and going through, “produceth it a proper size.”

Mr. Lee.—It does not say shoe leather, or calf leather, or any thing else about it.

Mr. Serejant Bolton.—Do you remember being at Manchester Races, 1767.

A. No.

Q. Did you see Mr. Arkwright at any time?

A. Yes.

Q. When might you see him?

A. I suppose about twenty years since; or about twenty-one years since or thereabouts; somewhere thereaway.*

Q. Now, recollect yourself, and tell us what passed between you and Arkwright, when you saw him?

A. I will tell, as near as I can. There was a gentleman, a tradesman in Bolton, one Thomas Rothwell; this Thomas Rothwell and I were pretty intimate; I met him in Manchester at a certain time, and he asked me, “Could you like to see Mr. Arkwright? he is in town.” With all my heart, says I. He said, “If I had a mind, he could bring me into his company, or bring him “into Mrs. Jackson’s, to have a glass together, and we might have a bit of dis-“course together.”

Q. Did you get together?

A. Yes, he brought him in, I remember into a little apartment, I believe the parlour of the house; we fell into some conversation about engines; at that time I was making another engine for a gentleman in Manchester, that they gave me a premium for. It happened I was there at that time, and Mr. Arkwright; and accordingly we fell into conversation, and I began to tell him he had got my invention. I told him, I had shown the model of it to John Kay, the method I intended to use the rollers, because John Kay’s wife had told me that before, how it happened, and Mr. Arkwright and them could never deny it. I told him, I had been informed that he had hired Kay, for twenty or twenty-one years, for about half-a-guinea a week, or something more, I dont know what; but, however, I should go on, if I would. I told him which way she told me he came by it. He said very little about it: when I told him, he never would have had the rollers but through me, he put his hand down in this way, and never said a word.

* When Higs said he had seen Arkwright twenty or twenty one years before the Trial, he alluded to his first seeing him at Leigh, which happened soon after Arkwright’s marriage. The conversation in Mrs. Jackson’s parlour took place about thirteen years before the Trial.

Q. You will please to repeat that, I don't hear you.

A. I shall, as near as I can; would you have me repeat all again?

Mr. Justice Buller.—No, only what you said last.

A. I happened to meet with Thomas Rothwell.

Q. What discourse had you with Arkwright about the rollers?

A. We were in some discourse about the rollers: I told him he would never have known them but for me; and he put his hand in this manner; I remember very well in this manner, to his knee, and that was the answer he gave; also he told me, when I told him it was my invention, suppose it was, he says, if it was, he says, if any man has found out a thing, and begun a thing and does not go forwards, he lays it aside, and any other man has a right in so many weeks or months, (I forget now) another man has a right to take it up, and get a patent for it.

Mr. Serjeant Bolton.—**Q.** Mr. Arkwright said, it was no matter if a man does not proceed upon a thing, but let it lie by so many weeks or months, he, or any other man, might get a patent for it?

A. Yes, I cannot tell how that is, says I, for I never was much concerned in law.

Q. Have you actually ever made, or not, any of these carding machines?

A. I have made carding machines, but not with these individual things, as this is; there are various forms.

Q. Did you ever make a machine that gives a perpetual roving?

A. Yes, I did, the very same as that is.

Q. That made it a continual roving?

A. Yes.

Q. Had you a little cylinder, like that, to take off the cotton from the large one?

A. I had a cylinder, like that, to take off the cotton from the large one; but you will excuse me, both my cylinders were of a size.

Q. But, however, that cylinder behind took off from the other cylinder, for the perpetual carding?

A. Yes, Sir.

Q. How long is it since you made those?

A. It is about twelve, or between twelve or thirteen years; nay, I am sure it is twelve years since.

Q. What did you do with them; did you sell any of them?

A. Yes, Sir, I sold them.

Q. For use to the manufacturers?

A. Yes, I did.

Q. How many did you?

A. I suppose four or five, but then I never made but one in this method; I tell nothing but the truth.

Cross-examined by MR. SERGEANT ADAIR.

Q. You never made but one in that method?

A. No.

Q. When did you make that?

A. About twelve years ago.

Q. Who did you make it for?

A. For one Mr. Walmesley.

Q. You never made but one of that kind?

A. No I did not.

Q. It did not answer; it was a new experiment?

A. It did not answer the end the gentleman wanted it for: you know it is nothing to me, I had nothing to do but work as I was ordered.

Q. What was the nature of that?

A. To take the carding off perpetually.

Q. What sort of carding?

A. Just such as is round this, only garters were put on the same way; first and foremost, I made a cylinder of a board, and got it turned, I had workmen of my own: then when that was turned, I had got a mahogany board, and made them the breadth of the card, to fit; after that, when I had screwed them on with screws upon that cylinder, I drew them over that cylinder; then I got them throwed again, or turned; and after that I took and dressed the edges of the card a little narrower, to give liberty for the other to come in; I took the card this way, and laid it down sideways, to take up but little room, and by that means it brought the teeth so close together, as made a perpetual carding.

Q. You placed them across the cylinder, as those are, or round it like filleting?

A. No, they were put round, like this.

Q. You never made but one of them?

A. No.

Q. Do you know where it was used?

A. Yes, there was a man in the town that worked upon them.

Q. What use did you put those rollers to, that were in proportion to five to one?

A. What use?

Q. Aye.

A. I made them on purpose to spin cotton.

Q. To spin?

A. Yes, and to rove too.

Q. Upon your oath, did you ever apply them to roving of cotton?

A. I will tell you how I did it: I got a board of flat wood, as this is; I took the carding first, and rolled it with another board, till it was a little harder; I laid loose the card at first; then I run it through the roller, to make it stronger; then, after that, I run three, four, or five through, till it was thick enough; then I put them all together through and through again, till we made it coarse thread as this is; afterwards I put in the coarse thread, I put it in the roller again, and made it fine.

Mr. Sergeant Bolton.—The roving and spinning are done with the same rollers.

Mr. Sergeant Adair.—Q. When and where did you apply them to that purpose?

A. In the town of Leigh. I did not follow this new manufacture; I was only improving myself, as I had a large family at that time, and was not able to follow it. I thought, when I came a little abler, when I could get a friend to assist me, being poor, and having a large family, I was not willing any body should steal it from me.

Q. Now, Mr. Highs, this was an experiment you made for your information?

A. It was an experiment undoubtedly; I used but two spindles at that time.

Q. You meant to preserve the benefit of it, if afterwards you should be able to avail yourself of it?

A. I did, Sir.

Q. Now what knowledge had you, how came you to suppose, Mr. Arkwright ever got that from you?

A. I have no further knowledge than what I told you, Kay's wife told me.

Q. You, yourself dont know?

A. I cannot tell which way he got it.

Mr. Sergeant Bolton.—We have that Kay, a clock-maker, that will tell your Lordship how this Arkwright got it from him.

Mr. Erskine.—Your Lordship will observe, No. 6 conveys the description of the rollers used by Mr. Arkwright, not in the roving but the spinning machine; and if you add 6 and 9 together, it is the spinning machine when together.

Mr. Lee.—Now, let them spin and rove together at the same time.

[*The Wheels, accordingly, were set in motion.*]

Mr. Sergeant Bolton.—The one forms the coarse thread, the other the fine one; the same machine will do both things.

Mr. Bearcroft.—What we mean to convey an idea of to your Lordship, is, that that machine which is now worked, if the tin can was absent, is in truth the spinning machine, which is specified under the first patent; the one is fine and the other coarse.

Mr. Justice Buller.—That is the spinning, I suppose, which is upon the spindle?

Mr. Bearcroft.—Yes.

A Juror.—I want to know, whether what he has got upon that wheel, he took out of the can?

Mr. Bearcroft.—The very same; it is done in the same manner, and by the same rollers, and this will do it.

Mr. Erskine.—Break the thread, and put it behind, and the gentlemen will take notice of that part next; my Lord, that is the thing for which he had a patent that is expired; one wheel goes five turns to one of the other.

Mr. Sergeant Bolton.—Q. Now, in fact, with your rollers, you did exactly the same thing?

A. I did, Sir.

Q. You roved it, and made the finer thread with your rollers, as this does now?

A. I did.

Q. And your principle was, that your motion went five to one, to the other?

A. It did, Sir; that is my own invention.

Mr. Sergeant Bolton.—You will find, as to that principle of the wheel acting five to one, we are totally left in the dark by the specification.

Mr. Justice Buller.—From the size of the wheels being different he says this man's invention was of a different proportion of wheels, as to their principle of operation, and there is nothing of that sort in the patent.

Mr. Erskine.—No, my Lord; we say, this difference of wheels, invented by this most ingenious man, was taken by Mr. Arkwright from him, and he claims the whole benefit of it by this patent, and we say, that destroys the whole of his patent.

Mr. Cowper.—Let us not have more spinning than is necessary.

Mr. Sergeant Bolton.—Nor speaking than is necessary.

No. 4.

The Evidence of John Kay.

JOHN KAY, *sworn.* Examined by MR. LEE.

Q. Do you remember, Mr. Kay, being at Manchester Races in any particular year, and meeting Mr. Arkwright there?

A. No, Sir, I did not; I was not there.

Q. What place was you at?

A. At Warrington; at the time of the Manchester Races he came to Warrington.

Q. In what year was it?

A. In the year 1767.

Q. What was it Arkwright applied to you about, or said to you; how did he introduce himself to you?

A. He comes to a public house, and I comes up there; he said he was going to a wheel-maker, one Edward Ashmore, to get a few wires bended, and he wanted a few bits of brass turned, and asked, where he could get them turned. I said if he would go down the street, he would meet with a clock-maker, where he might get them done. He came to our house, I was at work, and asked, If I could do those things for him? I said I would see about it; and I did it; he paid me the next day, and came again, and wanted something else; and when I had done it, he went about his business. The third day, or the fourth, he came again, and wanted something else; I did him those things; and he asked me when I had done, if I would drink a glass of wine with him in Dale-street. I went with him; in our discourse, he asked me if mine was a profitable business. I said it was not: he asked me what I could get a week. I told him about fourteen shillings: Oh, says he, I can get more than you: I said what business may you be of. He said, "I was a barber, but I have left it off, and I and another are going

“up and down the country buying hair, and can make more of it.” We were talking of different things, and this thing came up, of spinning by rollers. He said, that will never be brought to bear, several gentlemen have almost broke themselves by it. I said, I think I could bring that to bear; that was all that passed that night. The next morning he comes to my bed side, and says, Do you remember what I told you last night, and asked, whether I could make him a small model, at a small expence? Yes, says I, I believe I can; says he, if you will, I will pay you. I went and bought a few articles, and made a small wooden model, and he took it with him to Manchester, and in a week or fortnight’s time, I cannot say which, he comes back again, and I made him another.

Q. Before you go farther, who did you get the method of making these models from?

A. From Mr. Highs, the last witness.

Q. Did you tell Mr. Arkwright so?

A. I told him, I and another man had tried that method at Warrington.

Q. You made him a model?

A. I made him two models, and he took one to Preston; Burgoyne’s election was about that time.

Mr. Lee.—I understand that was in 1768; you say General Burgoyne’s election at Preston, was at that time.

A. Yes—I cannot say I can say any more upon that affair—He took it away with him.

Q. Look at that, was that the sort of model or was it at all like that?

A. It was with rollers.

Q. It was with double rollers in that way?

A. Yes, with four pair of rollers; this has only two.

Q. Were they fluted?

A. No.

Q. Neither of them?

A. No.

Q. Neither top nor bottom?

A. No.

Q. Did they turn equally when at work, or one faster than the other?

A. No—one faster than the other.

Q. What was the purpose of that?

A. Why, on purpose to draw cotton out finer.

Q. Were do you live, Kay?

A. I live at Warrington.

Q. You have seen those kind of things worked ?

A. Yes.

Q. Was the purpose of your discovery, you had from Higs, to do the like things now in that engine ?

A. Yes.

Q. First to rove it, then to make it finer, but to give it a proper consistency ?

A. Yes, we had it roved by a second, a hand wheel at that time.

Q. It was for the purpose of roving, with one roller, and afterwards spinning it with the other rollers ?

A. Yes.

Q. After he took your model away, and carried it to Manchester, you had some other conversation with him, do you recollect ?

A. Yes, and I went with him.

Q. Did you live with him there ?

A. I was with him at the time of the election in 1768 ; about thirteen weeks with him.

Q. Was you working with him as a mechanic ?

A. Yes, I went there to make a clock for him.

Q. Now pray did you ever make any other models for him, or for any body else ?

A. No, not at that time, not till such time as I went to work for him at Nottingham.

Q. You did go afterwards to Nottingham ?

A. Yes.

Q. When ?

A. As soon as the election was over.

Q. That was in March, 1768 ?

A. It was ended in April, I believe.

Q. Now, how long did you work with him ?

A. I cannot tell, four or five years perhaps, I cannot say how long.

Q. Well, afterwards Mr. Arkwright obtained his patent at a considerable distance of time ?

A. Yes.

Q. When did you hear he had obtained it ?

A. James Hargrave came and told me he had got his patent.

Q. Where is he ?

A. He is dead—I could not help myself, you see I did not know any thing at all about it.

Q. You must know, whether at that time it was his own invention, or he had it of you?

A. James Hargrave told me I should have lodged a caveat.

Q. Dont tell what James Hargrave said, you must know, whether it was his own invention?

A. I know very well he did not invent the rollers.

Q. You know very well he did not invent the rollers.

A. No.

Q. On the contrary, you know he had them from you?

A. Yes.

Q. And you had them from this poor Highs?

A. Yes.

Q. And you told him so?

A. Yes, I told him so many a time.

Cross-examined by MR. COWPER.

Q. You lived with him before he gained his patent?

A. Yes.

Q. Parted with him upon very good terms?

A. I dont know upon what terms I parted with him.

Q. I dont know whether I have a right to ask you, Did you leave his house without his knowledge?

A. Yes.

Q. I must not ask you, whether any thing else left his house at that time: you fled from his service?

A. Yes.

Q. By what apprehension did you leave him, whether well, or ill-founded. I will ask you this, Was there not at least a charge of felony against you?

A. They pretended so, but they could not find any thing against me.

Q. I ask, whether you did not fly from him upon the charge of felony?

Mr. Bearcroft.—I have no objection to your asking him, whether he had stole any body's invention.

Mr. Lee.—Ask him that, who stole the invention?

Mr. Cowper.—There is a deal of difference between stealing a tankard, when invented, or the invention of making a tankard.

Q There was a charge against you, well or ill founded?

A. I was at Nottingham, and he took my property away.

Mr. Justice Buller.—Who had took them?

A. Mr. Arkwright had.

Q. He had taken your goods, had he?

A. Yes.

Mr. Cowper.—What I want to know, which I desire you to give me an answer to, had not you run away from his service upon a charge of felony being exhibited against you?

A. I cannot tell what was charged against me.

Q. You cannot tell whether you run away upon the fear of a charge?

A. He told me something when I came back; I did run away.

Q. You heard soon after, of this patent, which you knew to be your's or Highs' invention and not Arkwright's?

A. Yes.

Q. And you talked of a partnership, I suppose?

A. Yes.

Q. You made no secret of it?

A. No.

Q. You being a poor man, it put you to no expence to complain to any body about the theft of the invention?

A. No.

Q. Did you apply to any body when the nine causes were here?

A. Yes.

Q. Did you hear them talked of, before they were tried, that they were to be so?

A. Yes.

Q. And did you, before that, publicly complain Arkwright stole those rollers?

A. Yes.

Q. Were you brought up then?

A. Yes, Sir.

Q. You was not examined upon the first trial?

A. No.

Q. Was you examined upon the second trial?

(No Answer.)

Mr. Lee.—I have sent for the brief, to shew he was put down as a Witness?

Mr. Justice Buller.—Kay, what were the things, Mr. Arkwright had taken out of your house?

A. Several tools.

Q. Where they tools respecting this business?

A. Yes.

Q. Was that the subject of the charge against you?

A. Why, I was making another machine in my house, to spin Jersey, which I thought of while I was at Nottingham, I might compleat it, I believe he thought I was making this machine, and that was his intent.

Q. You was making a spinning machine?

A. I was making a thing to spin Jersey; before I went to Nottingham I pulled that thing to pieces.

Q. You dont understand my question. Were the tools, which Mr. Arkwright had taken out of your house, the subject of the charge of felony against you; was it upon that account, he said you was to be charged with felony?

A. I believe he did; he told my wife I had stole things from him.

Q. Did he take those things, as the things stolen?

A. No; I brought them out of Lancashire.

Q. Tell what it was Mr. Arkwright took away?

A. Several tools, compasses, pliers, and vice, and other things.

Q. Did he take any thing besides tools?

A. Yes, a pair of sleeves, a spying glass I had, and locks and brass wheels I had brought with me, to make a movement with, from Lancashire; I had not time to make it, and I brought them with me.

Q. What was the spying glass?

A. That was a small spying-glass, which drew into four joints, that was mine. I brought it from Nottingham.

Mr. Erskine.—It is my duty in this place to answer, I have now in my hand my brief, which I had in 1781.

Mr. Sergeant Adair.—It is not properly evidence.

Mr. Erskine.—I can tell my Lord and the Jury why he was not called.

Mr. Justice Buller.—You had better not state it.

Mr. Erskine.—You will observe the objection to my stating it, comes from Mr. Sergeant Adair.

Mr. Lee.—That it is not now evidence is objected—the observation is enough to obviate that.

Mr. Justice Buller.—Surely.

Mr. Lee.—Q. Did Arkwright ever pretend to prosecute you for this pretended felony?

A. Yes, he offered to do it.

Q. Did he do it?

A. No, I never saw it.

Mr. Justice Buller.—Q. When did you get back to Nottingham again?

A. I never went to Nottingham again.

Mr. Lee.—Q. It is suggested to me; did Mr. Arkwright require you to enter into any obligation or bond, not to do any thing in this way of business?

A. Yes, at the time I was at Preston with him.

Q. In the year 1768?

A. Yes.

Q. After you had given him that model?

A. Yes.

Q. Was he then well to live, or in a situation not much better than you were?

A. He was a poor working man.

Q. He was?

A. He was, and I too; he got assistance to join him in this affair, and I agreed to work for him as a servant.

Q. He got a bond, did he?

A. Yes.

Q. What was it for?

A. To serve him so many years.

No. 5.

The Evidence of Sarah Kay.

SARAH KAY, sworn. Examined by MR. ERSKINE.

- Q. You are the wife of the last witness ?
A. Yes, last Michaelmas it is twenty-six or twenty-seven years since.
Q. You remember, then, I suppose, when he worked for Highs ?
A. Yes, I remember his making a small model.
Q. When did you see or know any thing about rollers, by which cotton is spun ?
A. That was about the beginning of the year 1763.
Q. Where did you first see it ?
A. At a place called Leigh.
Q. Who had them ?
A. Mr. Highs had them.
Q. Do you remember your husband getting any models made of those ?
A. That one I remember, and one that he made for Arkwright—He made one for Highs, and then he made one for Mr. Arkwright.
Q. Do you remember when he made the model for Highs ?
A. In the year 1763.
Q. Do you remember when he made the model for Arkwright ?
A. At the time of Bourgoyne's election.
Q. How do you know it was for Arkwright that he made the model ?
A. My husband told me so.
Q. You have seen Arkwright and him together ?
A. Yes, all the day over.
Q. About the time he was getting this model made ?
A. Yes.
Q. And had he this model at the time, to take with him ?

A. Yes, he asked whether he would make him a small model at a small expence.

Q. You saw them together all day?

A. Yes, after he had made the first model, he took it off with him some where or other, and came back to my husband, and asked if he could make another.

Q. He took it off somewhere or other, and came back to your husband, and asked him if he could make him another?

A. Yes.

Q. Was there another made?

A. Yes.

Q. Did you see this model of the rollers for drawing the cotton thread?

A. Yes, for spinning.

Cross examined by MR. CHAMBRE.

Q. You are sure it was in 1763?

A. In 1763, my husband and Mr. Highs began it.

Mr. Erskine.—Q. When was the first model you ever saw?

A. That my husband made for Mr, Highs.

Q. When was that?

A. In the year 1763.*

Q. Now, when was it he made the model for Arkwright?

A. In the year 1767.

* When Sarah Kay said her Husband and Highs began to make a model in 1763, she alluded to the Jenny, and her evidence corroborates the statement of Thomas Leather. The Jenny was made in 1763, or 1764, the Water-frame in 1767. She saw her Husband and Highs at work on a Spinning Machine in 1763, and probably thought it was the same her husband shewed to Arkwright in 1767.

EXPLANATIONS OF THE PLATES.

PLATE 1. *Distaff Spinning.*

PLATE 2. *Peg Warping.*

THE threads of the warp were divided by the pegs, each alternate thread going under the centre peg, and the succeeding thread over it. This division of the threads, called the lesse, was preserved during the weaving. At the other end of the warp the threads were passed round two pegs in a similar manner.

PLATE 3.

FIGURE 1. *Hand Cards.*

FIGURE 2. *Roving by the Hand Wheel.*

FIGURE 3. *Spinning by the Hand Wheel.*

The cotton after being combed or carded between the hand cards, was scraped off them in rolls about twelve inches long, and three-quarters of an inch in diameter. These rolls, called cardings, were drawn out into rovings on the hand wheel. In figure 2 the cardings are represented lying across the knee of the rover. From the spindle of figure 2 the rovings were taken to figure 3, to be spun into weft. In figure 3 the roving lies in the lap of the spinner. On the spindle of figure 3, the weft was finally prepared for the weaver. In roving, the cardings were drawn out in an angle of forty or forty-five degrees from the point of the spindle; in spinning, the rovings were drawn out nearly in a right angle. The Hand Wheel was first used in the woollen manufacture.

PLATE 4. FIGURE 1. *The Loom.*

The warp is wound upon the yarn beam *A*; the less is carefully preserved by rods *B*; one half of the threads pass through one heald, and the other half through the other. The healds *C* are looped in the middle, and the threads of the warp go through the loops. From the healds the warp passes through the reed *D*, which is fixed in a moveable frame called the lathe, *E*. A cross-piece, *F*, on the upper part of the lathe rests on each side of the loom, and the lathe swings on this cross-piece. The weaver sits on the seat *G*, and with his foot presses down one of the treddles *H*, which raises one of the healds and each alternate thread of the warp. The weaver holds the picking peg in his right hand, and with it drives the shuttle from one side of the lathe to the other, between and across the threads of the warp. The shuttle passes between the reed and the weaver, and leaves behind it a shoot of weft; by pulling the lathe towards him with his left hand this shoot of weft is driven close to the cloth made by former casts of the shuttle. The cloth is wound upon the cloth beam *I*.

FIGURE 2. *The Lathe used when the Shuttle was thrown by the Hand.*

FIGURE 3. *Mr. Kay's Lathe.*

K The reed; *L L* iron rods; *M M* moveable slides which work on the rods from *N* to *O*, and are fastened to *P* the picking peg by a string *Q*; *R R* boxes on each side of the lathe to contain the shuttle. The shuttle is placed

in one of the boxes, and the weaver by a sudden jerk with the picking peg moves the slide from *N* to *O*, and drives the shuttle along the sled or shuttle race *S*, into the box on the other side.

FIGURE 4. *The Shuttle.*

T F Wheels on which the shuttle moves along the sled. *U* The weft, fixed in the shuttle upon a skewer. As the shuttle flies across the warp the weft unrols from the skewer and runs through a small hole *V* in the side of the shuttle.

PLATE 5. *The Warping Mill.*

The warper sits at *A*, and turns the reel *B* by the wheel *C* and rope *D*. *E* The yarn on bobbins. *F* The slide, which rises and falls by the coiling or uncoiling of the cord *G* round or from the axle of the reel *H*. *III* Wooden pins similar to those used in Peg-warping.

PLATE 6. FIGURE 1. *Higs' Jenny.*

A The spindles turned by strings from the drum *B*. *C* The rovings; *D* the wire loops; *E* the clove which rises and falls in the groove *FF*, and is opened and shut by the latch *G*. When the clove is down at the spindles, at *H* it is opened and the drum is turned which raises the clove by means of the cord *II*, which passing over pulleys is coiled round the bobbin *K*. As the clove rises the rovings slide through it; when the clove is raised five or six inches to *L* it is shut fast by the latch *G*, the drum is again turned which sets the spindles in motion and raises the clove by the coiling of the cord round the bobbin. The rising of the clove draws out the five or six inches of roving shut fast between the spindles and the clove into weft. When the clove is raised to *M* the roving is sufficiently drawn out; the bobbin is then moved by a latch from the lower part of the axle, nearer to the handle where the axle is of less diameter than the bore of the bobbin. The drum is then turned and the spindles again revolve giving to the weft the necessary twist. During this twisting of the weft the clove and the bobbin remain stationary, the axle of the drum turning within the bobbin, and a leaden weight, *N*, counterbalancing the clove. When twisted, the clove is lowered from *M* to *H* by the hand of the spinner, and the weft copped or wound upon the spindles. The drop rod *O* guides the weft upon the spindles. Figure 2. The Axle of the Drum square at *P* and round and of less diameter at *Q*. Figure 3. The Bobbin, which when at *P* turns with the axle, but when at *Q* remains stationary.

PLATE 7. *The Improved Jenny.*

The wheel *A* turns the cylinder *B* by a band *C C*. The spindles *D* are turned by strings from the cylinder *B*. The rovings are placed on the frame *E* and pass through the clove *F* to the spindles. The clove moves in the grooves *G G*. When the clove is close to the spindles at *H* it is opened and drawn from them eight or ten inches to *I*, the rovings sliding through it, it is then shut fast and the spindles are set in motion by turning the wheel *A*. As the spindles revolve, the clove is drawn back from *I* to *K* by the left hand of the spinner; this stretches out the rovings into weft. When stretched out, the spinner holds the clove at *K* with the left hand, and gives the proper degree of twist by turning the wheel *A* with the right hand. The weft is then copped by turning the clove to *H*. *L* the drop rod. The spindles in the first improved Jennies were turned by strings from a drum on a perpendicular axis.

PLATE 8. *A Section of the Water Frame.*

A The rovings. *B* The first pair of rollers. *C* The second pair of rollers which revolve faster than the first pair. *D* The spindle. *E* The bobbin. *F* a drum, the bands from which turn four spindles.

PLATE 9. *A front View of the Water Frame.*

PLATE 10. Carding Engine.

FIGURE 1. A Section of the Carding Engine.

A The feeder. *B* Rollers which take the cotton from the feeder and deliver it upon the great cylinder *C*. *D* The concave cover. *E* The second cylinder. *F* The crank and comb. *G* The funnel. *H H* Two rollers. *I* The perpetual carding. *K* The can.

FIGURE 2. A Bird's Eye View of the Carding Engine.

A The feeder. *B* Rollers which take the cotton from the feeder and deliver it upon the great cylinder *C C*. *D* The concave cover. *E* The second cylinder. *F* The comb. *G* The funnel. *H* The rollers. *I* The perpetual carding. *K* The can.

FIGURE 3. Front View of the Carding Engine.

A The concave cover. *B B* The first or great cylinder with the cards nailed on it longitudinally. *C* The second cylinder with the fillet cards nailed on it circularly. *D* The comb worked by the upright rods *E E* and the cranks *F F*. *G G* The rollers. *H* The can.

FIGURE 4. The old second Cylinder, with the Cards nailed on it longitudinally.

FIGURE 5. Mr. Wood's second Cylinder, with the fillet Cards nailed on it circularly.

PLATE 11. FIGURE 1. A Bird's Eye View of the Roving Frame.

A A Cans containing the perpetual cardings. *B* The first pair of rollers. *C* The second pair of rollers, revolving quicker than the first. The rovings by passing through these two pairs of rollers are drawn out and lengthened, two of the rovings are then united at the rollers *D*, and are again drawn out by another pair *E*, which revolve quicker than the pair at *D*.

FIGURE 2. Front View of the Roving Frame.

F The fourth or last pair of rollers, represented at *E* on figure 1. From these rollers the rovings pass to the spindles *G*.

FIGURE 3. The Roving Can used by Mr. Arkwright instead of the spindles.

PLATE 12. The Mule.

FIGURE 1. *A* The Roving. *B* The first pair of rollers. *C* The second pair, revolving quicker than the first. The roving and rollers are placed on a fixed frame. *D* A moveable carriage on which the spindles stand. This carriage recedes from the fixed frame when drawing out the yarn and returns to it when the yarn is copped or wound upon the spindles. *E* a spindle. The spindles are turned by strings from a drum, each string turning two spindles. *F* The drop rod.

FIGURE 2. *G G G'* The fixed frame on which stand *H H*. The second pair of rollers represented at *C* Figure 1. *I I* The moveable carriage. *K* The spindles. *L* The drop rod.



M. P. Calverno del.

Printed by C. Habington.

Distaff Spinning.

Fig. 2.

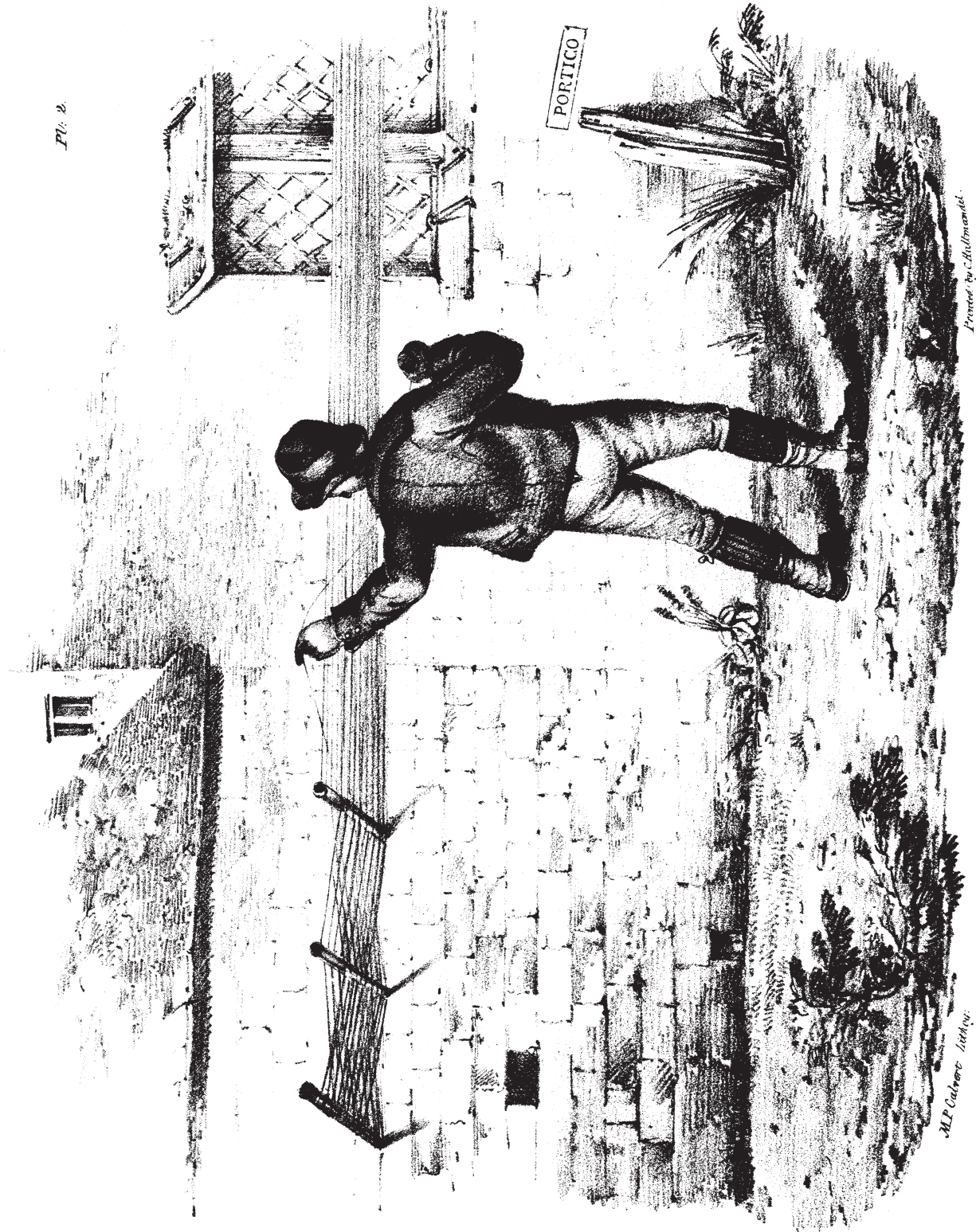

M.P. Colburn Lithogr.

Printed by C. Gillman and Co.

PEG WARPING.



Printed by C. Hallman

FIGURE 1.—HAND CARDS.
FIGURE 2.—ROVING BY THE HAND WHEEL.
FIGURE 3.—SPINNING BY THE HAND WHEEL.

M.P. Cabore, Lithog.

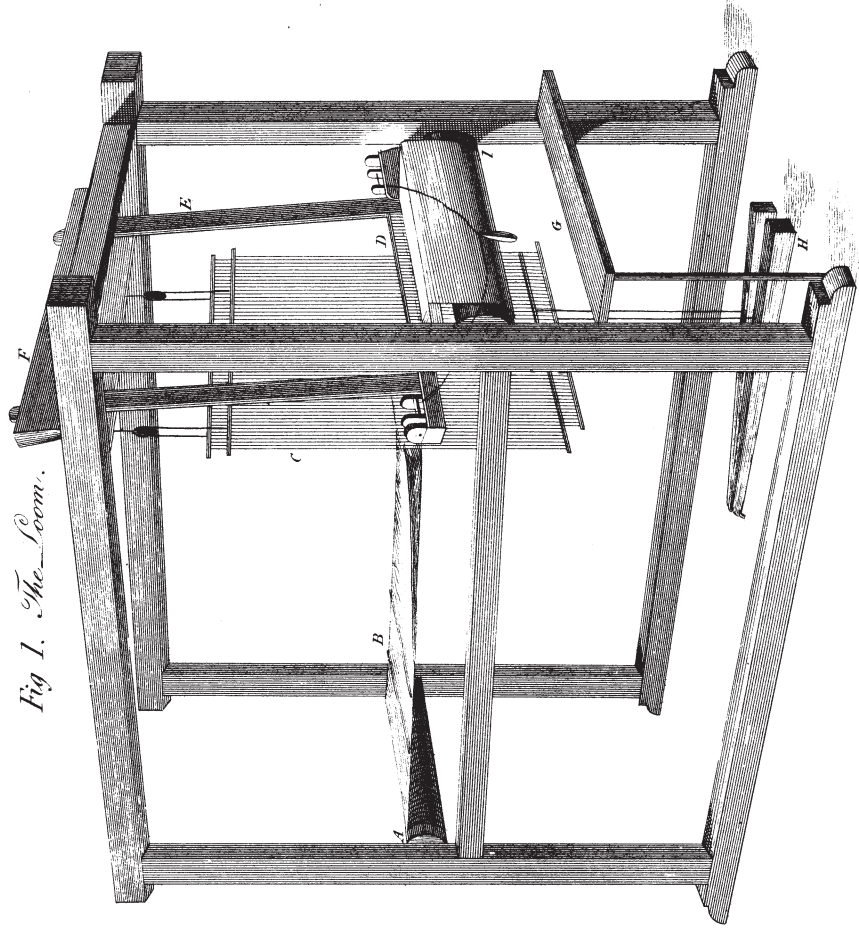

Fig. 1. The Loom.

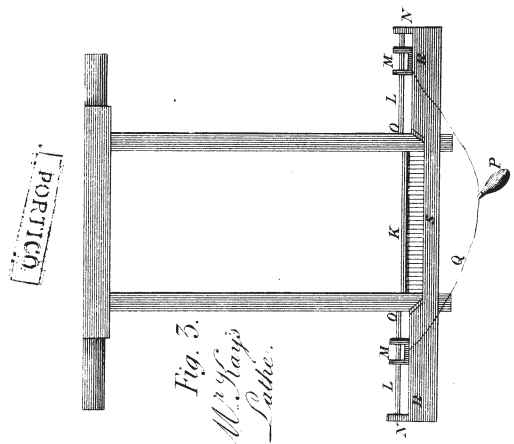

Fig. 3.
Mr. Hoag's Shuttle.

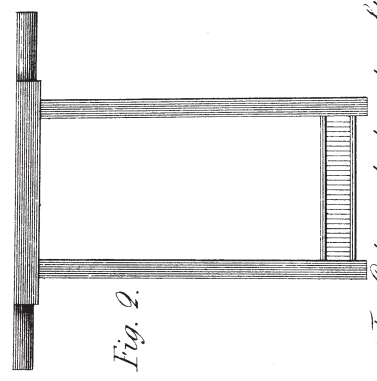

Fig. 2.

The Shuttle used when the Shuttle was thrown by the hand.

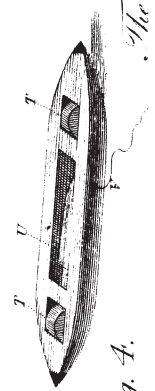
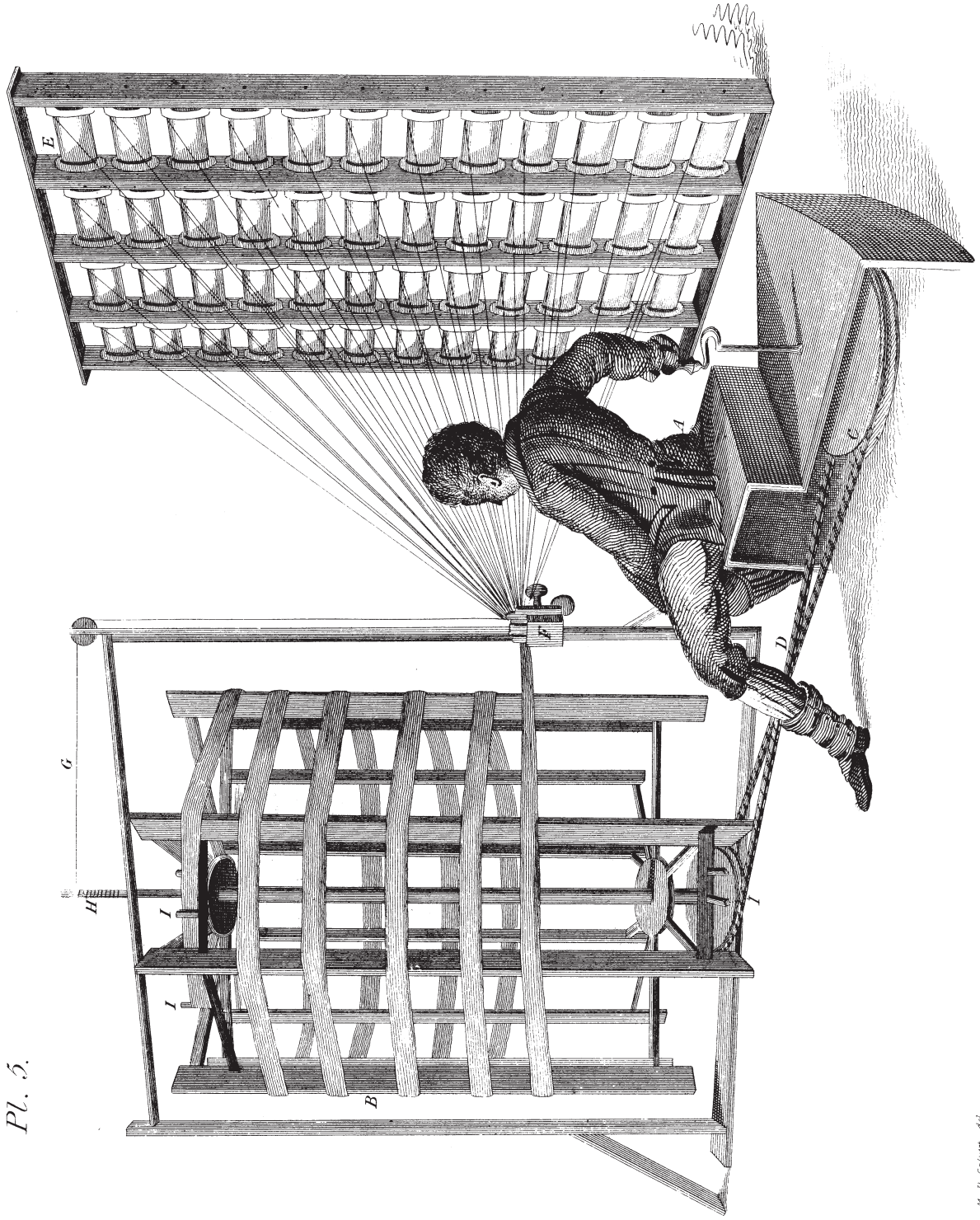

Fig. 4.
The Shuttle.

Pl. 5.



M. P. Colver del.

W. B. & Co. Sculp.

The Warping Mill.

WOLLETON

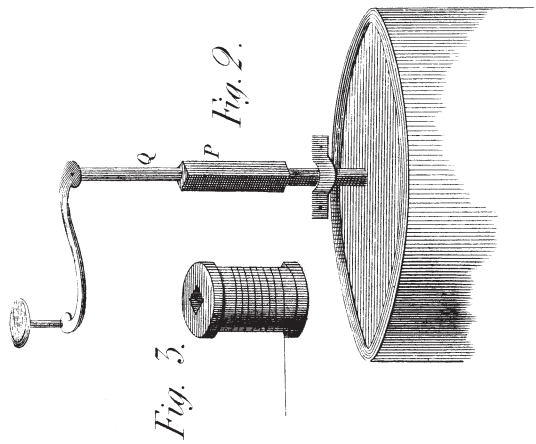

Fig. 2.
Fig. 3.

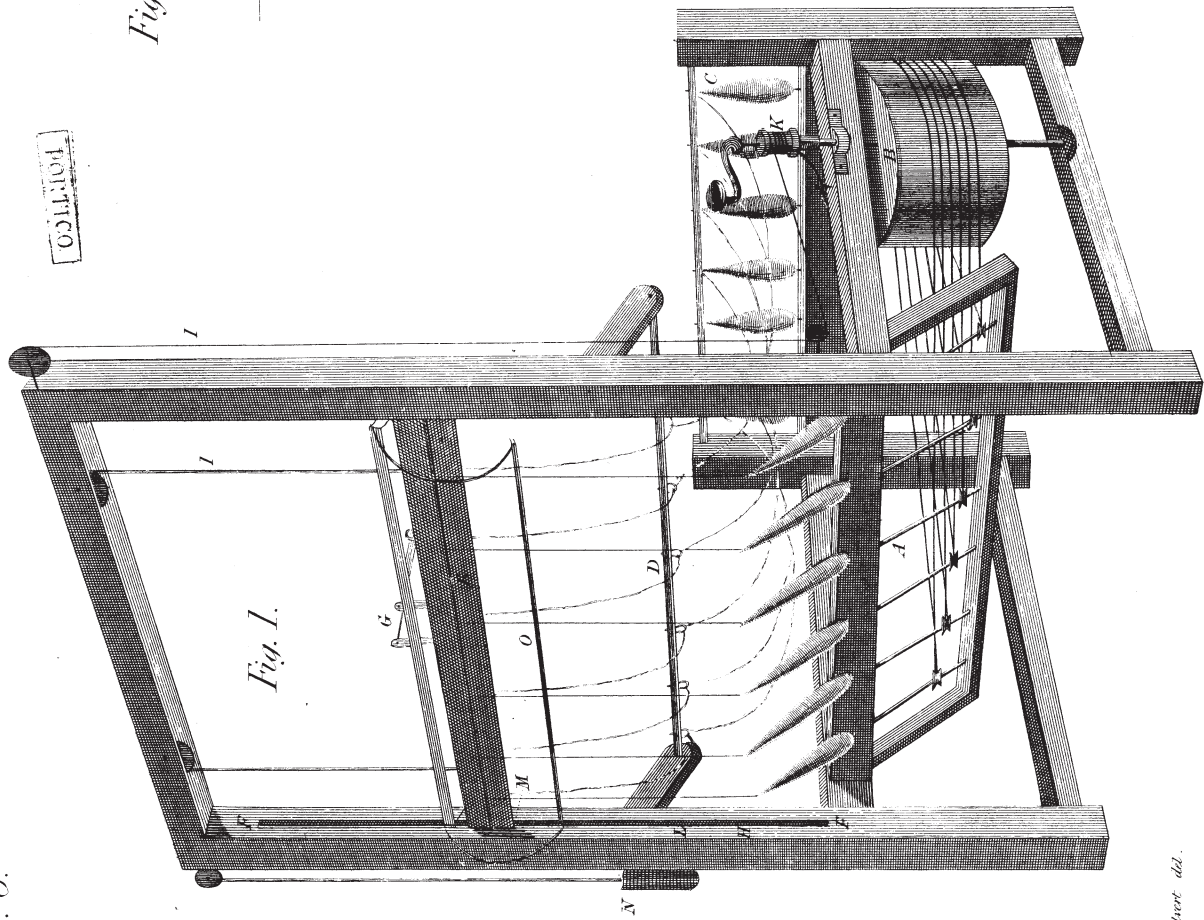
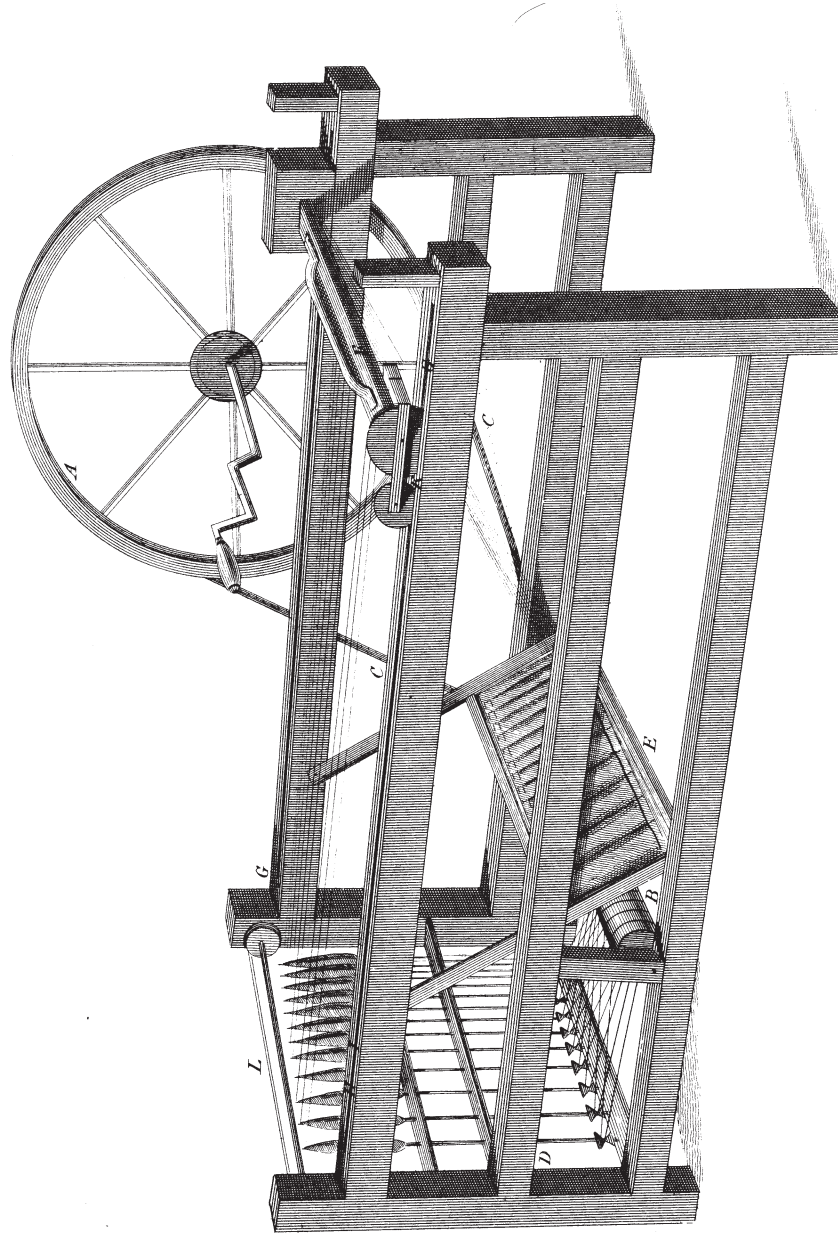

Fig. 1.

Hights' Jenny.

Pl. 7.



The Improved Jenny

M. P. Gibber del.

Jacob & Co. makers N.Y.

Pl. 8.

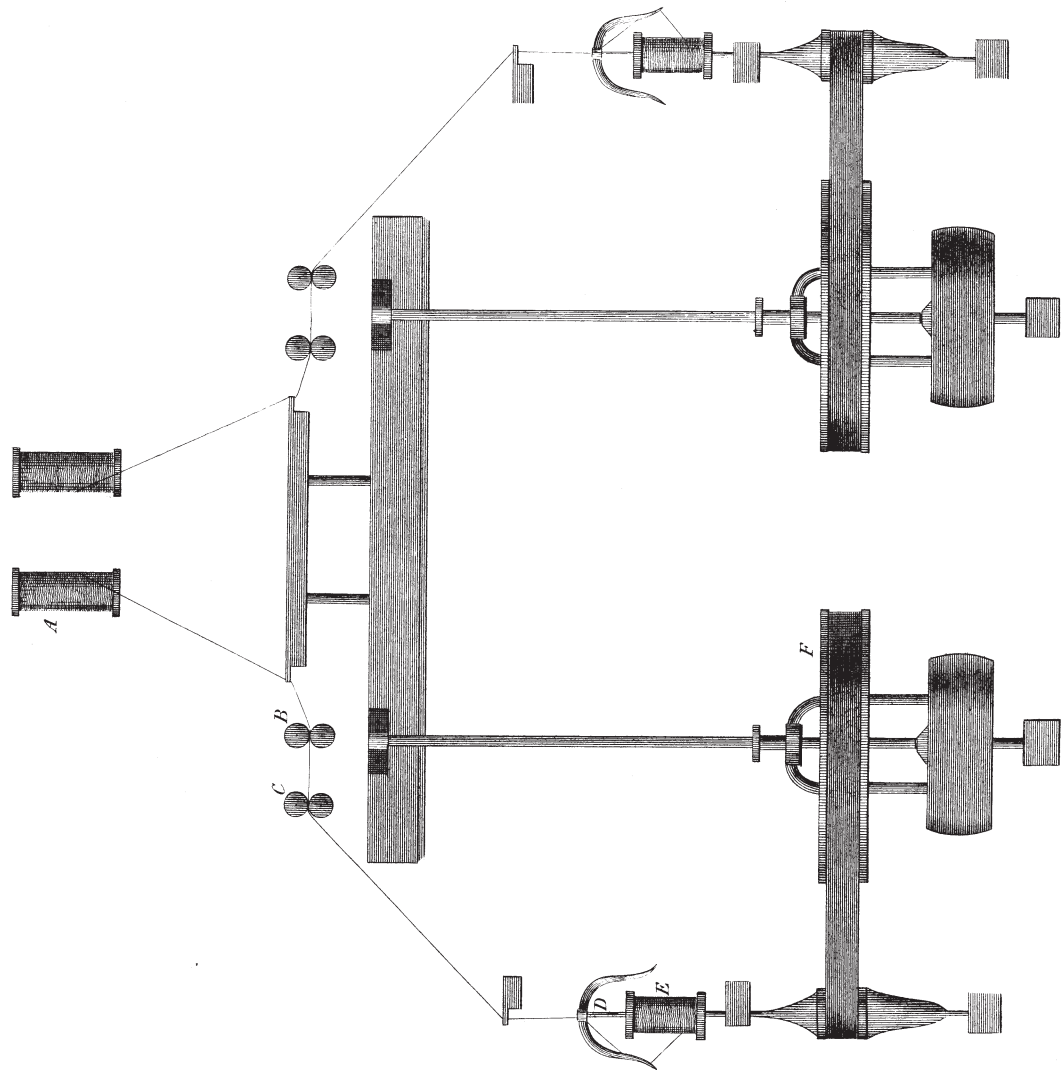

A Section of the Water Frame.

M. F. Cabot del.

Leach & Robinson Sc.

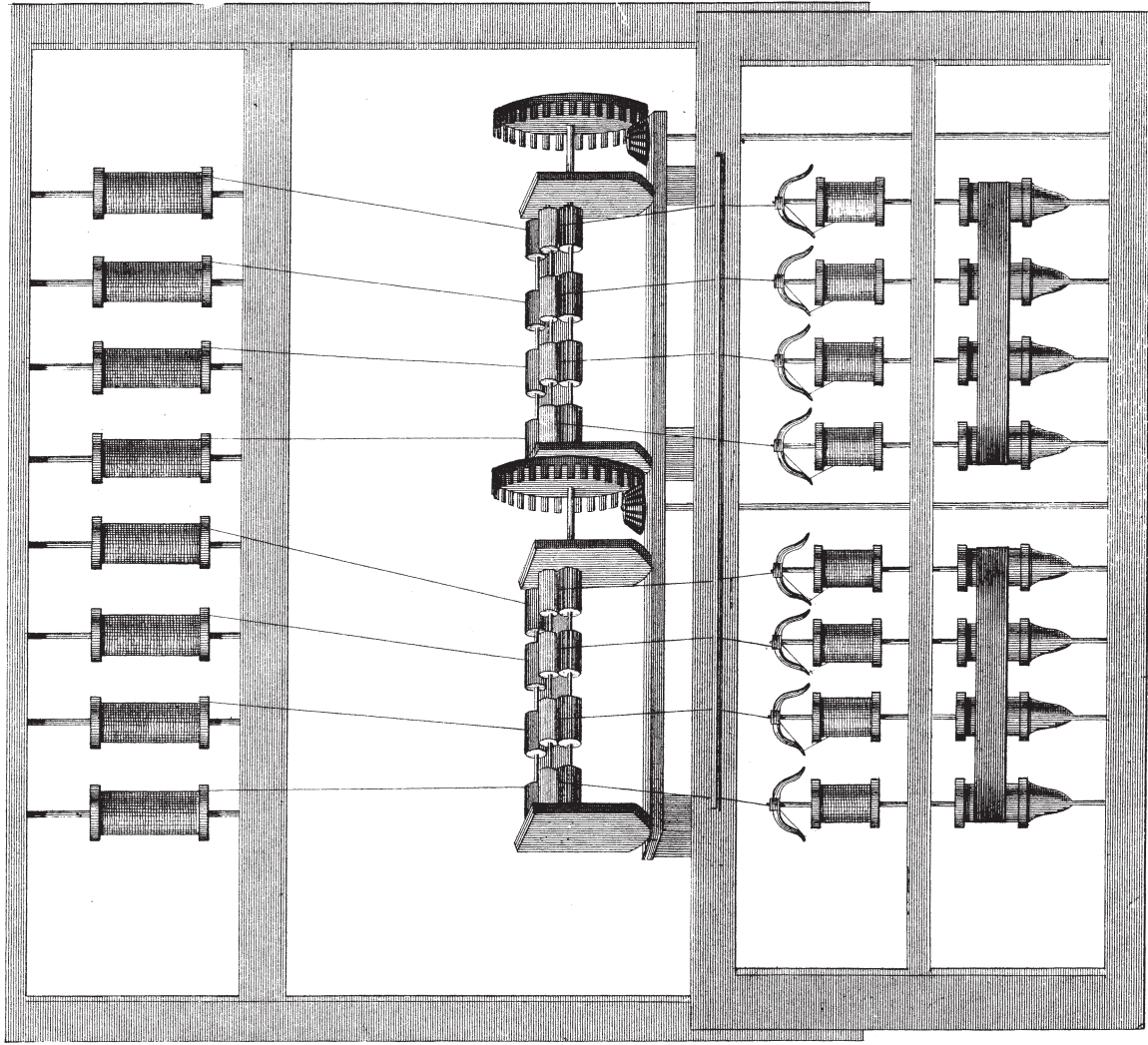

A front view of the Water Frame.

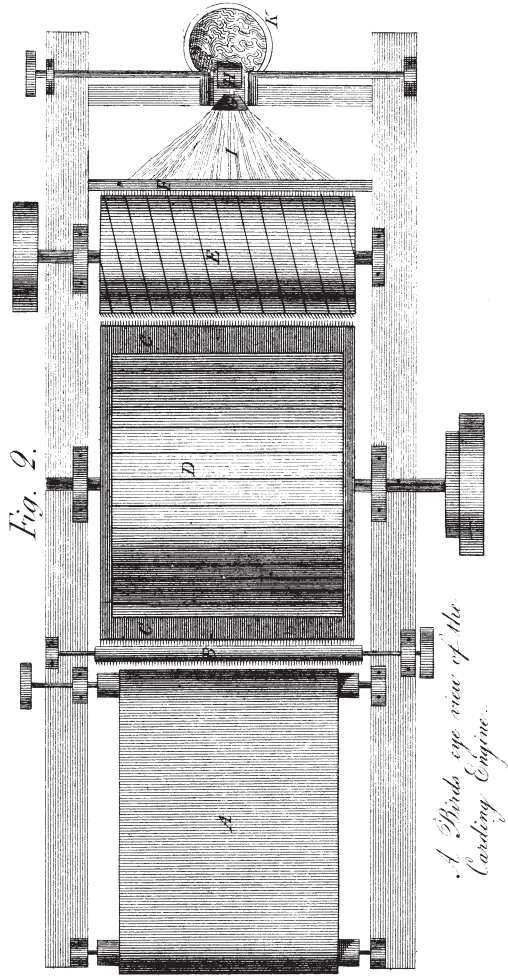

Fig. 2.

A Birds' eye view of the Carding Engine.

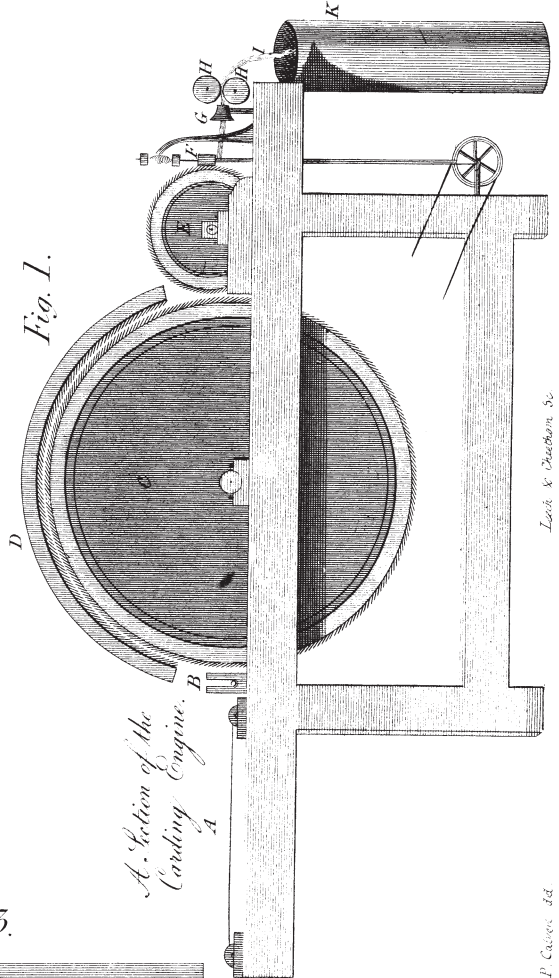

Fig. 1.

A Section of the Carding Engine.

Lock & Co. Boston, U.S.

M. P. Casper, Del.

Fig. 3.

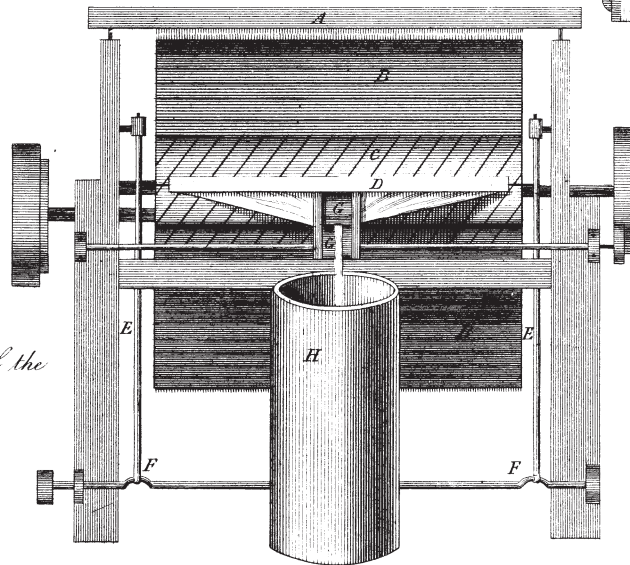

Pl. 10.

A Front view of the Carding Engine.

PORTICO



Fig. 4.

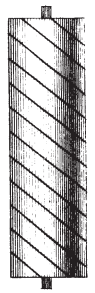

Fig. 5.

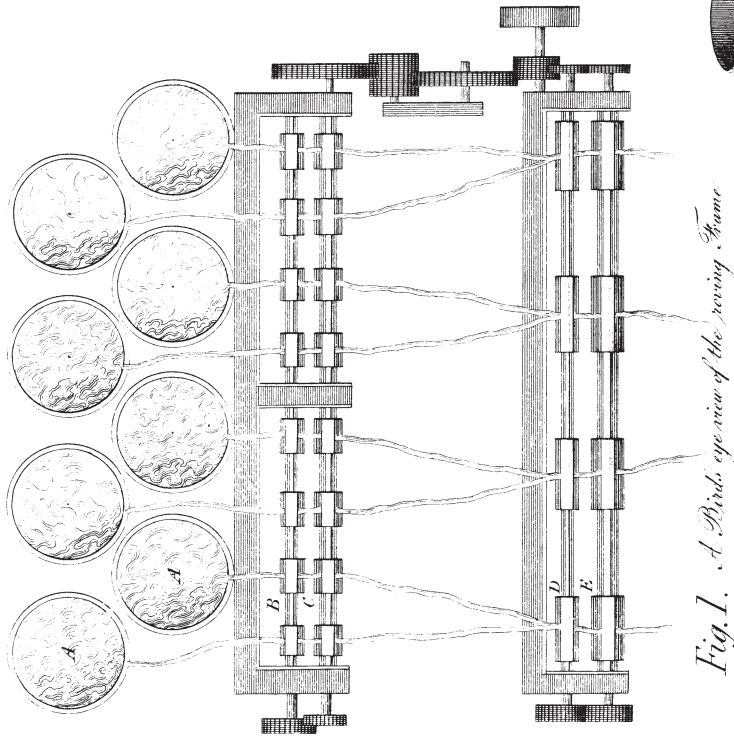

Fig. 1. A Bird's eye view of the reeling frame

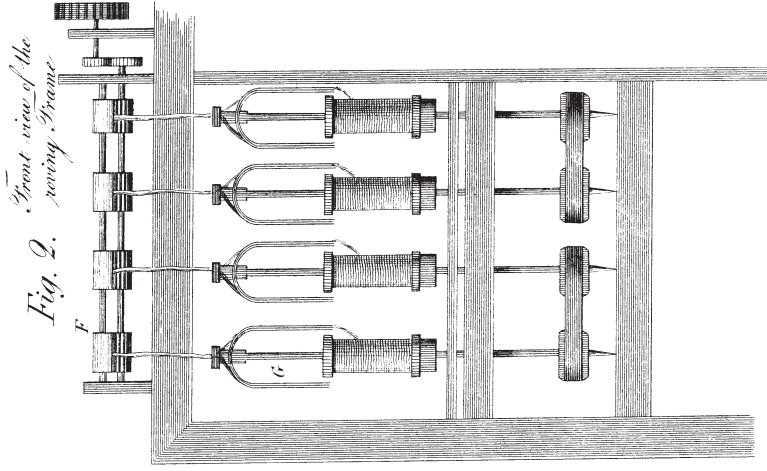

Fig. 2. Front view of the reeling frame

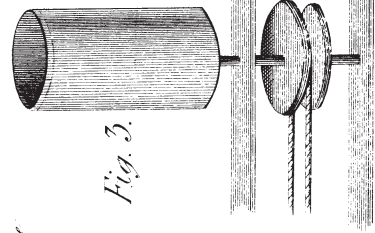

Fig. 3.

The reeling can used by Mr. Arkwright instead of the Spindles.

POSITO

Pl. 12.

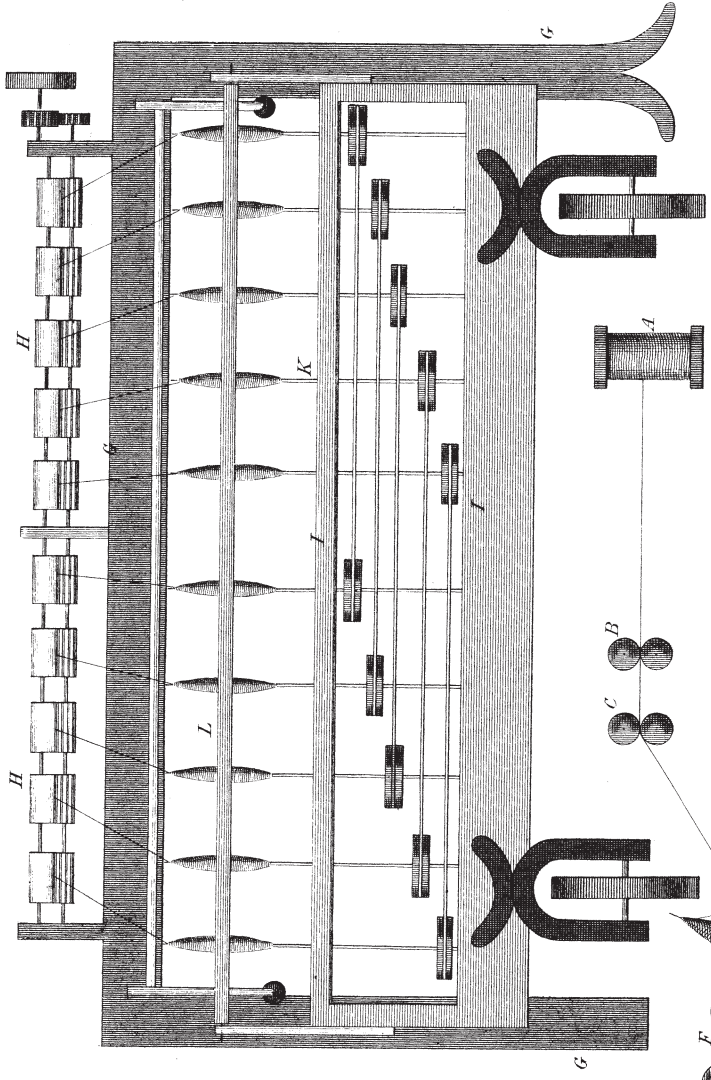

Fig. 2.

PORTICO

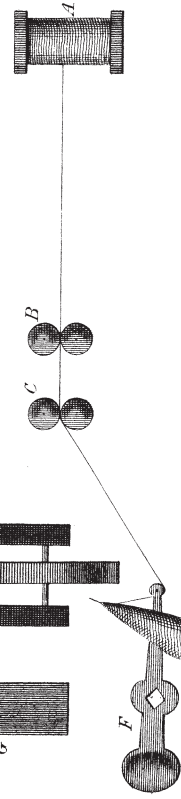
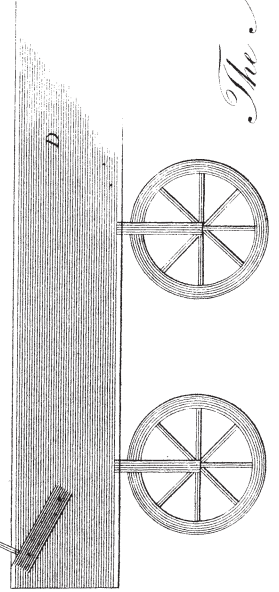

Fig. 1.



The Mule

M. P. Colver del.

Leach & Chesham Sc.