

THE BASKETRY BOOK

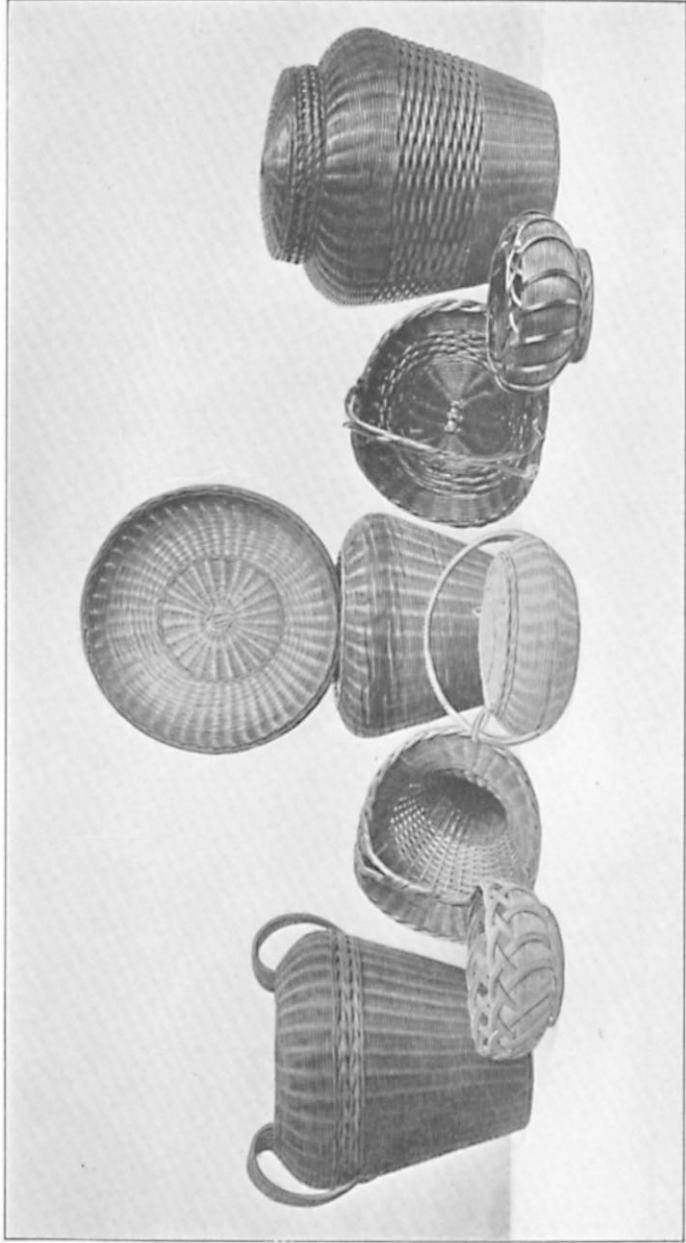

VARIETY OF BASKETS SHOWING WHAT CAN BE MADE WITH REED

THE BASKETRY BOOK

TWELVE LESSONS IN REED WEAVING

BY

MARY MILES BLANCHARD

MASTER CRAFTSMAN OF REED BASKETRY

NEW YORK

CHARLES SCRIBNER'S SONS

1928

COPYRIGHT, 1914, BY
CHARLES SCRIBNER'S SONS

Printed in the United States of America



CONTENTS

	PAGE
INTRODUCTION	xi
CHAPTER I	
MATERIALS, TOOLS, PREPARATION	3
CHAPTER II	
FUNDAMENTAL WEAVES	6
CHAPTER III	
BASE	16
CHAPTER IV	
WORK-BASKETS. (MODELS 1, 2, AND 3)	21
CHAPTER V	
BASKETS WITH SIMPLE HANDLES. (MODELS 4, 5, 6, AND 7)	29

CHAPTER VI

	PAGE
LILY-SHAPE FLOWER BASKETS WITH HANDLES. (MODEL 8)	36
(DEMONSTRATING VARIATIONS OF A MODEL BY DIFFERENT WEAVES)	

CHAPTER VII

FLOWER BASKETS. (MODELS 9, 10, 11, AND 12)	48
(DEMONSTRATING VARIATIONS OF A MODEL BY DIFFERENT MEASUREMENTS)	

CHAPTER VIII

CANDY BASKETS WITH AND WITHOUT LIDS. (MODELS 13, 14, 15, AND 15 ²)	55
---	----

CHAPTER IX

INDIAN CENTRES	62
VIOLET BOWL. (MODEL 16)	68
TABLE JARDINIÈRES. (MODEL 17)	69

CHAPTER X

SCRAP BASKETS. (MODEL 18)	72
-------------------------------------	----

CONTENTS

vii

CHAPTER XI

	PAGE
SCRAP BASKETS. (MODELS 19 AND 20) . . .	79

CHAPTER XII

OVAL BASE	84
OVAL BASKETS. (MODELS 21 AND 22) . . .	87

CHAPTER XIII

CULLING-FLOWER BASKETS. (MODEL 23) . .	90
LARGE GATHERING BASKET. (MODEL 24) . .	92

CHAPTER XIV

TABLE OF WEAVES	94
TABLE OF COILS	97
SCALE OF MEASUREMENTS FOR MODELS GIVEN IN THE TWELVE LESSONS	98
TABLE OF BORDERS	99



CHAPTER XV

ANSWERS TO QUESTIONS	101
--------------------------------	-----

ILLUSTRATIONS

Variety of Baskets Showing what Can Be Made with Reed	<i>Frontispiece</i>
	FACING PAGE
Figure I. Tools	4
Figure II. "Weaves"	10
Figure III. Four-Spoked Base	18
Figure IV. Base	20
Figure V, Model 1	22
Figure VI, Models 4 and 5	30
Figure VII, Models 6 and 7	34
Figure VIII, Model 8	38
Diagram No. 0. Base with Thirteen Spokes . . .	<i>page</i> 37
Diagrams No. 1 and No. 2	42
Diagrams No. 3 and No. 4	43
Diagrams No. 5 and No. 6	44
Diagrams No. 7 and No. 8	45
Diagrams No. 9 and No. 10, Handle-Bar	46
Figure IX, Models 9, 10, 11, and 12	50
Diagram No. 11. Inserting Split Handle-Bars . .	<i>page</i> 50
Diagram No. 12. Winding a Split Handle	52
Figure X, Models 13, 14, 15, and 15 ²	56

	FACING PAGE
Diagrams No. 13, No. 14, No. 15	60
Diagram No. 16. Indian Centre No. 1. Sixteen Spokes	64
Diagram No. 17. Indian Centre No. 2. Sixteen and one half Spokes	64
Diagram No. 18. Indian Centre No. 3. Sixteen Spokes	65
Diagram No. 19. Indian Centre No. 4. Twenty-four Spokes	65
Diagram No. 20	<i>page</i> 67
Figure XI, Models 16 and 17	68
Diagram No. 21. Correct and Incorrect Base Spokes	<i>page</i> 73
Diagram No. 22. Correct Side Spokes	74
Diagram No. 23. Correct and Incorrect Side Spokes . .	74
Figure XII, Model 18. Scrap Basket	76
Figure XIII, Models 19 and 20	80
Diagram No. 24	<i>page</i> 84
Diagram No. 25. Winding of Intersection of Needles and Threads in an Oval Base	<i>page</i> 85
Diagram No. 26. Right Side of an Oval Base	86
Diagram No. 27. Under Side of an Oval Base	86
Diagram No. 28. Separating Spokes in an Oval Base	<i>page</i> 86
Figure XIV, Models 21 and 22	88
Figure XV, Models 23 and 24	92

INTRODUCTION

BASKETRY is one of the most ancient of crafts and probably the origin of all the textile arts of the world.

The process of interweaving twigs, seeds, or leaves is practised among the rudest nations of the world; and as it is one of the most universal of arts, so also does it rank among the most ancient industries.

Authorities on the subject declare that there has never been a tribe in any part of the world that has not employed some mode of making baskets, and that all the weaves in use at the present day have their origin in baskets made by our savage ancestors.

A craft of such antiquity is naturally of surpassing interest.

The ancient Britons appear to have excelled in the art of basket making, and the shields of the ancient warriors and also their huts were made of wicker-work; and their boats of the same material, covered with skins of animals, attracted the notice of the Romans. Herodotus mentions boats of this kind on the Tigris and Euphrates.

Among many uncivilized tribes of the present day baskets of a superior order are made and applied to various useful purposes.

The North American Indians prepare strong, water-tight baskets from roots. The Indians of South America weave baskets equally useful from fronds of their native palms, while the Hottentots of South Africa are as skilful in using reeds and the roots of plants, and display great adroitness in the art of basket weaving.

The Chinese and the Japanese excel in the application of bamboo in the weaving of baskets and the making of furniture, and their products are of unequalled beauty and finish.

In England and America the value of manual training is being recognized, and basketry is taking an important place. The art has proved itself capable of immense development. New shapes as well as new designs in weaving are constantly suggesting themselves, and the most advanced teachers find that there is a great deal in the craft yet to be learned.

A thorough and steady training of twelve months is necessary to become proficient, and three years to acquire sufficient accuracy and speed (training the eye for shaping and the hand for regular and even weaving) to be able to fill correctly orders for special designs, and to reproduce models from specified measurements.

George Wharton James has given us the thought that each basket has a significance in shape, design, and color all its own, and suggests that in our work

we follow the Indian idea of making the basket the exponent of something within ourselves; then the shape, design, and colors will all mean something more to us than what merely shows on the outside.

Train yourselves to imitate in form the simple things, and find your true inspiration in nature.

To be proficient in this task one must be persevering, accurate, neat, and capable of making the hand obey the mind.

THE BASKETRY BOOK

CHAPTER I

MATERIALS, TOOLS, PREPARATION

I. MATERIALS.

Rattan, imported from the East Indies, is used exclusively in the making of reed baskets. It comes to us from the manufacturer in round or flat strips of various sizes, ranging from No. 00 to No. 15, the former being the finest and also the most expensive reed. The reed can be purchased at basket factories in most of our large cities, or from retail dealers, in bales weighing from one pound to one hundred pounds. It is advisable to buy not less than five pounds of each required number and increase the pounds when necessary. Reed in all sizes can be procured from the following addresses:

The American Rattan & Reed Mfg. Co., Norman and Kingsland Avenues, Brooklyn, N. Y.

The New England Reed Company, 9 to 17 Green Street, Boston, Mass.

Louis Stoughton Drake, Inc., West Newton, Mass.

J. L. Hammett Company, 250 Devonshire Street, Boston, Mass.

The American Reedcraft Corp., 130-32 Beekman Street, New York City.

2. TOOLS.

- (1) Sloyd knife or penknife.
- (2) Side cutters or pliers.
- (3) Pincers.
- (4) Winding awl.
- (5) Awl. (See Fig. III.)
- (6) Tape measure.

- (7) Foot rule.
- (8) Pencil.
- (9) Good-sized tin dish pan.
- (10) Rubber finger-guards (when the skin becomes tender).

3. WINDING AWL.

This tool cannot be purchased in hardware stores, but a machinist can make it by taking an awl, a trifle smaller than an ordinary lead-pencil, flattening the end (as in Fig. I) and curving this end slightly upward. This instrument will be found invaluable in saving wear and tear on the hands, and in curving a weaver close to a spoke, where it is impossible to use the fingers.

4. PREPARATION.

The reed is received from the manufacturer in long skeins and must be drawn out one reed at a time from the loop end. The heavier material, which is to form the ribs or spokes of the basket, should be cut into lengths of the required number of inches, while the smaller reed, or "weavers," should be wound into circles about a foot in diameter, the ends being twisted in and out several times to prevent unwinding.

The reed must lie in tepid water for ten minutes before using it. When pliable, pour the water off and use the reed while damp. Should it dry out while using, place in water again, but reed that lies in water too long becomes brittle. The spokes, which have already been cut the required length, should be placed in any vessel that will take their

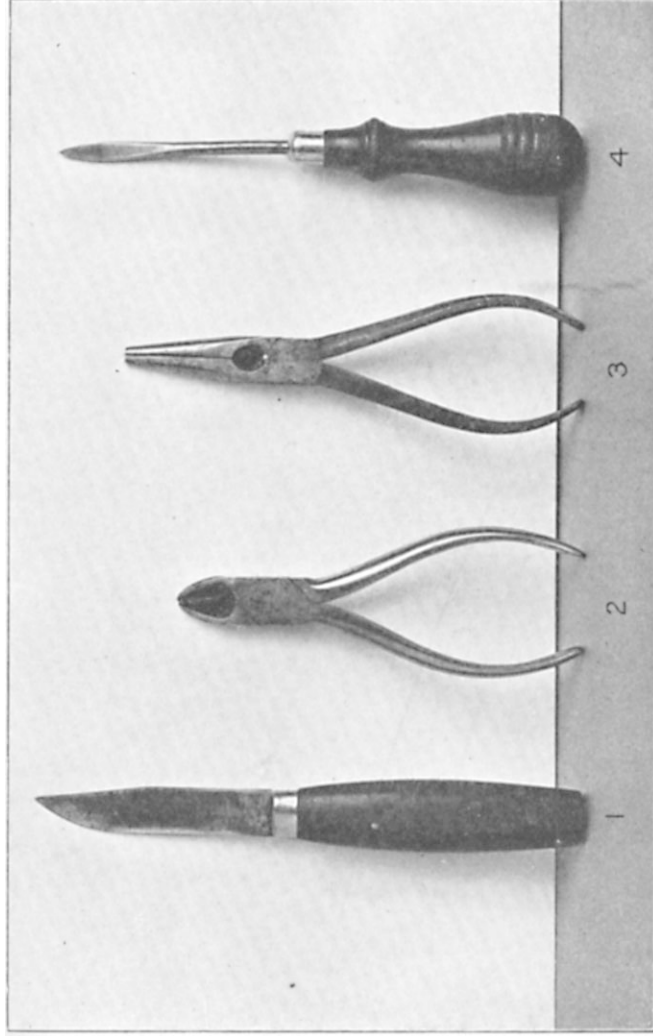

FIGURE I. TOOLS

1. Sloyd knife or penknife.

2. Side cutters or pliers.

3. Pincers

4. Winding awl.

length without bending and allowed to soak five minutes before using.

5. DEFINITIONS.

“*Spokes.*” The reeds which form the framework, viz.: ribs of the base or sides of the basket.

(a) *Base Spokes.* Spokes used in the base.

(b) *Side Spokes.* Spokes used in the sides of a basket.

(c) *Initial Spoke.* The spoke behind which the first weaver is placed.

(d) For convenience the spokes to the left of the initial spoke will be termed *X, Y, Z*; the initial spoke No. 1 and the spokes to the right of this spoke No. 2 and No. 3.

(e) “*Weavers.*” The reed or reeds woven over and under the spokes. These must necessarily be smaller in size than the spokes.

(f) The weavers will be designated by the same terms as the spokes behind which they start, viz.: Weaver starting behind the initial spoke is weaver No. 1.

(g) “*Stroke*” is the distance a weaver is carried in one movement, either in front or back of the spokes.

CHAPTER II

FUNDAMENTAL WEAVES

6. The eight fundamental weaves (Fig. II) will be developed in the lessons following, and can only be acquired by thoroughly understanding each weave as it is explained in the lesson. Make a practice of referring to this chapter, as the different weaves come into play, until each weave becomes second nature to you.

- (1) "*Over and under.*"
- (2) "*Double over and under.*"
- (3) "*Japanese weave.*"
- (4) "*Double Japanese.*"
- (5) "*Pairing.*"
- (6) "*Triple weave.*"
- (7) "*Coil.*"
- (8) "*Arrow.*"

7. GENERAL RULE. Weave from left to right.

8. OVER AND UNDER. (Fig. II, 1.)

In front of one spoke and back of one.

(a) *One Weaver.* When there is an *odd* number of spokes, the weaver is placed behind a spoke and carried in front of the next spoke, thus alternating over and under around the basket.

(b) *Two Weavers.* When there is an *even* number of spokes, carry the first weaver once around the basket, stopping in front of the spoke to the left of the initial spoke, *i. e.*, spoke Z (5 D). Insert a second weaver behind this spoke, or spoke Z, and carry it around the basket, allowing the second weaver to pass back of the spokes that the first weaver passed in front of, and in front of the spokes that the first weaver passed back of, and so continue the weave by carrying each weaver separately around the basket; keeping the first weaver always ahead of the second weaver, to prevent crossing.

9. DOUBLE OVER AND UNDER. (Fig. II, 2.)

In front of one spoke and back of one.

This weave is exactly the same as "over and under," except that two weavers are carried as one.

(a) *Two weavers* carried as one when there is an odd number of spokes. These two weavers are placed behind the same spoke and carried in front of the next spoke, thus alternating over and under around the basket.

(b) *Four weavers* carried as two pairs when there is an even number of spokes. Place two weavers behind the same spoke, and carry this first pair once around the basket, stopping in front of the spoke to the left of the initial spoke. Insert a second pair of weavers behind this spoke (*i. e.*, the one to the left of the initial spoke) and carry them around the basket and so continue by carrying each pair of weavers separately around the basket; keeping the first pair of weavers always ahead of the second pair, to prevent crossing.

10. JAPANESE WEAVE. (Fig. II, 3.)

In front of two spokes and back of one.

One Weaver. This weave cannot be used where the number of spokes is divisible by three.

11. DOUBLE JAPANESE. (Fig. II, 4.)

In front of two spokes and back of one.

Two weavers carried as one where the number of spokes is not divisible by three. Place the two weavers behind the same spoke and carry them as one, in front of two spokes and back of one.

12. PAIRING. (Fig. II, 5.)

In front of one spoke and back of one.

Two Weavers. This weave can be used on an odd or even number of spokes. Two weavers are placed behind two consecutive spokes. The weaver to the left, each time, is carried in front of one spoke and back of one, allowing it to cross on top of the weaver to the right.

“Pairing” differs from “over and under” in the fact that, in pairing, the weaver to the left, or back weaver, each time crosses over the front weaver (*i. e.*, weaver to right), while in “over and under” the weavers never cross each other.

13. TRIPLE WEAVE. (Fig. II, 6.)

In front of two spokes and back of one.

Three Weavers. This weave can be used on an odd or even number of spokes.

Three weavers are placed behind three consecutive spokes and each weaver (beginning with the

weaver to the left) is brought, in succession, in front of two spokes, and back of one, allowing it to cross on top of the two weavers to the right.

14. Notice the similarity between "pairing" and "triple weave."

In pairing, two weavers are used, and each weaver in turn passes over one weaver, and two spokes come into play.

In triple, three weavers are used, and each weaver in turn passes over two weavers, and three spokes come into play.

15. COIL. (Fig. II, 7.)

A coil is one row of heavy weaving around the basket, resembling a rope twist.

It is a variation of the triple weave, though four or more weavers may be used.

(a) *Three-Rod Coil.* Three weavers: In front of two spokes and back of one.

(b) *Four-Rod Coil.* Four weavers: In front of three spokes and back of one.

(c) *Five-Rod Coil.* Five weavers: In front of four spokes and back of one.

16. The following rule is imperative:

ALL COILS MUST BE REVERSED AND LOCKED.

17. REVERSING A COIL.

Example—Three-Rod Coil

Three Weavers. Each weaver measuring six inches longer than the circumference of the basket. *In front of two spokes and back of one.*

In beginning a coil allow at least two inches of each weaver on the inside of the basket. The weavers are carried around the basket as in triple weave, stopping before the initial spoke. For convenience, we will mark these three spokes (to the left of the initial spoke) *X*, *Y*, *Z*, and number the initial spoke and the two to its right 1, 2, 3.

At this point the weaving is to be reversed, as follows: Carry the weaver passing back of spoke *Z* (*i. e.*, the right-hand weaver) in front of spokes 1 and 2 and back of spoke 3. (Fig. II, 7.)

The weaver back of spoke *Y* passes in front of spokes *Z* and 1 and back of spoke 2. (Fig. II, 7.)

The weaver at *X* passes in front of spokes *Y* and *Z* and back of spoke 1 (*i. e.*, the initial spoke).

Explanation: In reversing a coil you reverse the weaving; that is, instead of carrying the left-hand weaver, you carry the right-hand weaver, and, if the coil is completed correctly, the left-hand weaver will finish behind the initial spoke and the other two weavers behind spokes 2 and 3. (Fig. II, 7.)

Notice that behind these three spokes there is the beginning of a weaver and the ending of a weaver. *These three pairs must be locked.*

18. LOCKING A COIL.

Behind each of these three spokes we have the beginning of a weaver and the ending of a weaver, which we will designate as "beginning weaver" and "ending weaver."

With the left hand hold the "beginning weaver" back of spoke 3, inward and away from the spoke, and with the right hand draw the "ending weaver"

back of the spoke 3 and under the coil to the outside of the basket, so that the two weavers lie flat, side by side.

Continue the same with the two weavers at spokes 2 and 1.

Trim the three weavers on the outside of the basket with a very slanting cut close to the coil; likewise the three on the inside of the basket.

19. ARROW. (Fig. II, 8.)

Two rows of weaving, converging at each spoke, and composed of:

- (a) 2 rows of "pairing."
- (b) 2 rows of "three-rod coil."
- (c) 2 rows of "four-rod coil."

Example—Three-Rod Arrow.

Three Weavers. Each weaver must measure twice the circumference, as it requires two rows to complete the arrow.

The first row of an "arrow" consists of a coil and must be reversed but not locked. (Fig. II, 8.)

In the second row each weaver, in turn, as it passes in front of the two spokes, is carried under the weavers to the right, instead of on top of them as in the first row. This causes the weavers of the second row to converge with those of the first row at each spoke.

Explanation of second row: Hold the two weavers to the right, with the left hand, and draw them up and out toward you, allowing the left-hand weaver to pass in front of two spokes, under these two weav-

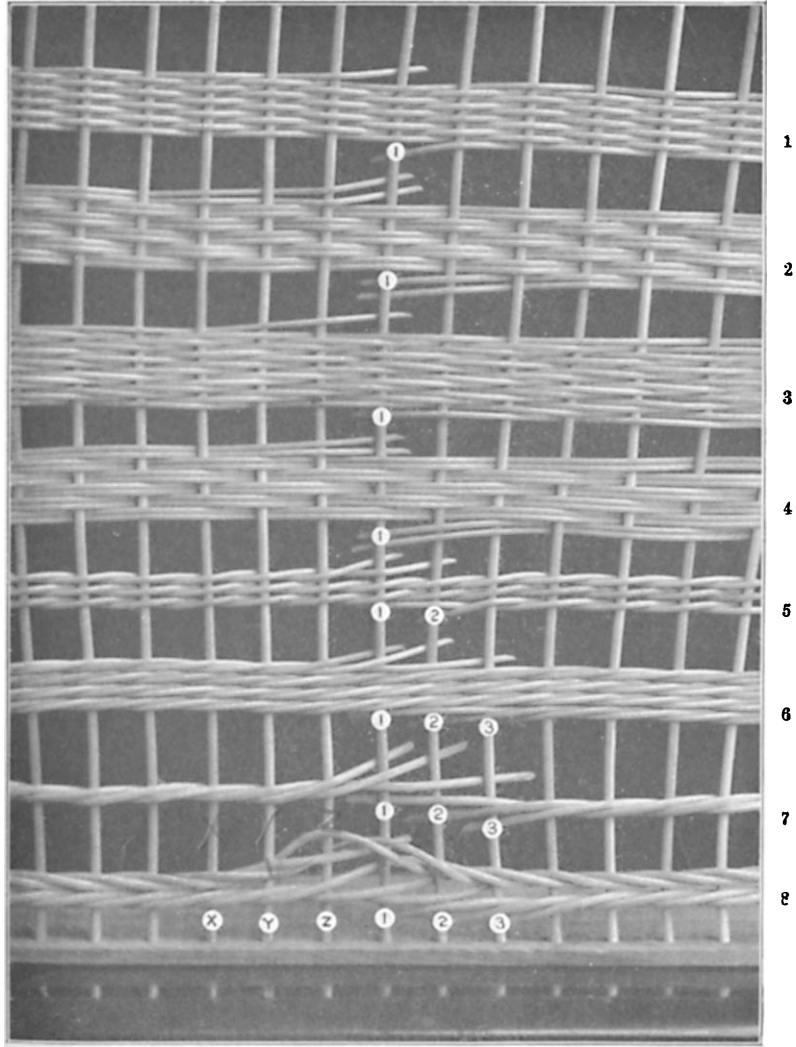

FIGURE II. "WEAVES"

- | | | | |
|--------------------|---------------------------|--------------|---------------------|
| 1. Over and under. | 2. Double over and under. | 3. Japanese. | 4. Double Japanese. |
| 5. Pairing. | 6. Triple. | 7. Coil. | 8. Arrow. |

ers, and back of the third spoke and out. Continue this around the basket, always taking the left-hand weaver until you come to the initial spoke, when you complete the "arrow." This is very different from reversing a coil and must not be confused with same.

Completing the "Arrow." Completing the second row of an "arrow," the first weaver ends back of the initial spoke and on the inside of the basket. (Fig. II, 8, X-1.) The second weaver to the left passes in front of two spokes, under the one remaining weaver to the right, and also under the first stroke of the second row of the arrow, ending behind spoke 2 on the inside of the basket. (Fig. II, 8, Y-2.) The third weaver passes in front of two spokes and under the two weavers which compose the first and second strokes of the second row of the arrow, and this third weaver ends behind spoke 3 on the inside of the basket. (Fig. II, 8, Z-3.)

In completing an "arrow" bear in mind that the weavers are lacing with the weavers that began the second row and have nothing to do with the first row. That row was completed when the weaving was reversed.

20. RULE.

- (a) First weaver ends back of the initial spoke.
- (b) Second weaver laces under the weaver which passes in front of spoke 2.
- (c) Third weaver laces under the two weavers that pass in front of spoke 3.
- (d) In a four-rod arrow, the fourth weaver laces under the three weavers that pass in front of spoke 4.

21. DOUBLE WEAVING.

Carrying two weavers as one, as: "double over and under," "double Japanese," "double pairing," and "double triple weave."

22. TERMS.

(a) *Turn of a Basket.* The point where the sides of the basket leave the base.

(b) *Shoulder of a Basket.* The turn at the top of a basket.

(c) *Opening of a Basket.* The space included in the border of a basket.

(d) *Border.* The finishing of a basket at the top, formed by the spokes.

(e) *Mending.* The insertion of a new weaver to continue the weave, when the previous weaver has been terminated.

(f) *Mending Spoke.* The spoke behind which the mending is done.

23. MENDING OVER AND UNDER.

Allow the short weaver to end behind a spoke. Make a slanting cut on the weaver to the right of the spoke and lay the new weaver back of the same spoke, trimming it on the left-hand side of the spoke.

24. MENDING PAIRING.

Same as mending "over and under."

25. MENDING DOUBLE OVER AND UNDER.

The method is the same as in single "over and under," but always insert the new weaver below, no

matter whether it is the under or upper weaver that is being mended.

26. MENDING JAPANESE WEAVE.

Allow the short weaver to end behind a spoke and trim the weaver on the right side of the spoke. Insert the new weaver down in the weaving on the right-hand side of the spoke to the left of the mending spoke (22*f*). Carry this new weaver back of the mending spoke, on top of the short end, and to the outside of the basket and continue the weave. Notice that the new weaver comes out just where the short one would have continued.

In a model that requires very neat weaving, mend "Japanese weave" like "triple weave" (28).

27. MENDING DOUBLE JAPANESE.

Mend as in single "over and under," always inserting the new weaver below, no matter whether it is the upper or under weaver that is being mended.

28. MENDING TRIPLE WEAVE.

Trim the weaver to be mended about one quarter of an inch on the right side of the mending spoke (22*f*). With the pincers, pinch this weaver on the left side of the mending spoke, and turn it down in the weaving on the left side of the mending spoke. Insert the new weaver in the weaving on the right side of the spoke to the left of the mending spoke. Pinch close to the weaving and carry the new weaver back of the mending spoke and to the outside of the basket. This process of mending "triple weave" is the neatest method and is used where the

inside of the basket is desired to be smooth; otherwise "triple weave" may be mended as in "Japanese" mending (26).

29. MENDING A COIL.

Allow the short weaver to end back of a spoke. Hold it away from the spoke on the inside of the basket and insert a new weaver to the right of it, close to the mending spoke. Allow the end of the new weaver to pass to the outside of the basket in the space to the left of the mending spoke and thus lock with the short end of the old weaver, so that the two weavers lie flat, side by side. Carry the new weaver back of the mending spoke and to the outside of the basket.

A coil may also be mended as described in 28.

30. MENDING AN ARROW.

The method in both rows is the same as mending a coil (29).

31. DIRECTIONS FOR MEASURING A BASKET.

(a) *Base*. The diameter of the under-side of the base without the arrow.

(b) *Height*. Place the basket on a table and take the perpendicular distance between the table and a rule laid across the top of the basket.

(c) *Opening*. The diameters from border to border.

(d) *Greatest Diameter*. The greatest distance between the sides of the basket.

CHAPTER III

BASE

32. As the base is the starting-point in making baskets and the most important factor, it is wise for the student to conquer this part of the weaving first. Make at least six perfect bases with the correct slope, straight spokes, and with no mistake in the weaving before attempting the sides of the basket. A base that is not correct should be ripped out, the materials resoaked and made over.

33. RULE FOR ROUND BASES.

(a) The spokes must radiate from the centre, be an equidistance from each other, and curve downward evenly.

(b) The weaving must be executed with equal tension, it must be smooth and very close. Draw the weaver down tight, so that it will press close to the weaving of the preceding row.

(c) The curve of a finished base should resemble an inverted saucer. In a four or five inch base, the centre should be three fourths of an inch from the table when the ends of the base spokes rest on the table.

(d) The base spokes should be cut one and one half inches longer than the required dimensions of the base.

34. MATERIALS.

Eight spokes, six inches long, No. 5 reed. Weavers No. 2 reed.

Soak the spokes and reed in tepid water for ten minutes. Place four of the spokes on a block of wood and, with the awl, pierce these four spokes successively in the centre, making a slit about an inch long and keeping them on the awl as seen in Fig. III. These four spokes are called the "needles" and the remaining four the "threads." Make a slanting cut on one end of each of the "threads" and push these four-pointed spokes, one at a time, through the slits of the "needles," drawing them half-way through the "needles." When one is in place the awl may be removed and the other three inserted. This operation is termed "threading the needles."

Holding the ends of the needles in both hands, curve them slightly downward from the centre out; likewise the threads. This helps to direct the spokes in the curve that you wish to weave the base.

35. THE BUTTON OF THE BASE.

Select a soft, mellow weaver of No. 2 reed and, with the pincers, crush the fibre about twenty inches from one end, so that the weaver can be turned back on itself without breaking. Place the spokes before you with the concave side down and one end of the needles pointing toward you. With the left hand pick the spokes up, having the thumb and back of your hand above and the fingers underneath the spokes. The "needles" will be vertical or parallel with your body and the "threads" horizontal. With

the right hand place the crushed point of the weaver in the outer left-hand angle, where the "threads" meet the "needles" (Fig. III, *a*), placing the long end of the weaver in front of the vertical spokes or "needles" and the short end underneath. With index finger and thumb of the right hand draw the long end of the weaver down in the outer right-hand angle (Fig. III, *b*), holding it in place with the middle finger of the left hand and bring the short weaver back of the "needles" up at the outer right-hand angle (Fig. III, *b*) and on top of the long weaver just carried down. Turn the spokes to the left, so that the "threads" are now pointing toward the body and the "needles" horizontal.

Move the position of the left hand each time you turn the base, always having the thumb and back of the hand on top, with the thumb resting on the centre of the spokes and the fingers underneath. Carry the short weaver in front of the "threads," close to the "needles" and down at the third angle (Fig. III, *c*), which is now in the position of *b* in the plate, holding it underneath with the middle finger of the left hand. Bring the long weaver under the threads and up at angle *c*, on top of the short weaver just taken down.

Turn the spokes to the left and carry the long weaver in front of the "needles" and down at angle *d*, and bring the short weaver back of the "needles" and up at angle *d*, on top of the long weaver just taken down.

Turn the spokes to the left and carry the short weaver in front of the threads and down at angle *a*, and bring the long weaver back of the threads and

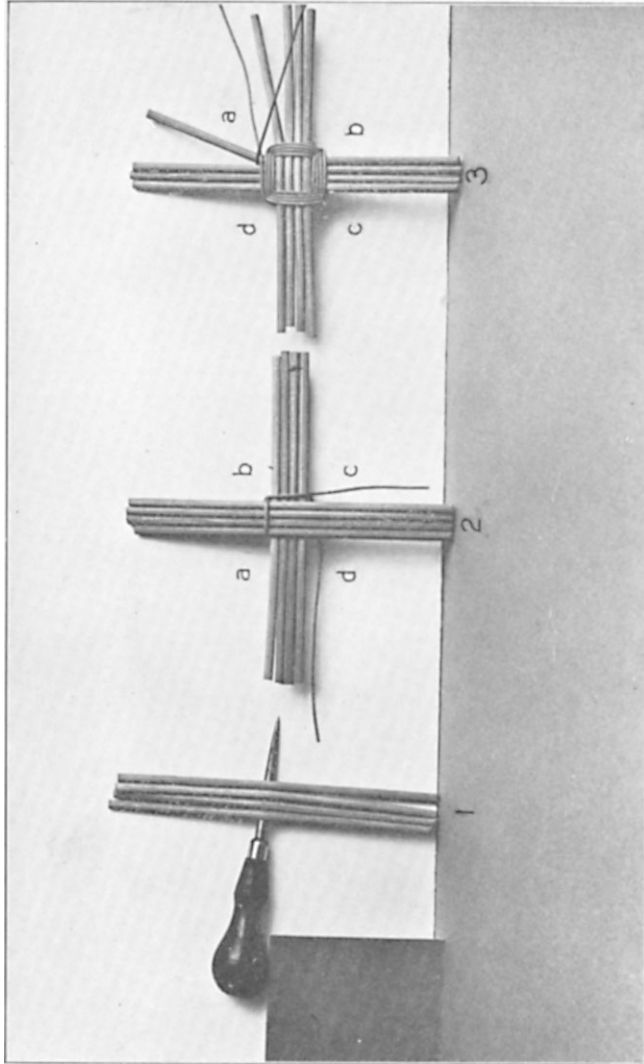

FIGURE III. FOUR-SPOKED BASE

1. Awl and needles.

2. Starting the button.

3. The button completed

up at angle a , on top of the short weaver just taken down.

This completes one circuit of the button, and you continue the weave until you have made four complete circuits and have four weavers crossing the two sets of "needles" and the two sets of "threads." (Fig. III, 3.)

This forms the button of the base, and, when woven correctly, the short weaver passes down in the *last* angle and the long weaver, which is underneath, is brought up between the two spokes to the left of this angle instead of at the angle. (Fig. III, 3.) The spoke to the left of the long weaver is the *initial spoke* of the base. (Fig. III, 3.)

36. THE WEAVING OF A BASE.

Japanese weave (10), in front of two and back of one, is the most practical weave for bases.

The spokes of the base must now be separated as in Fig. IV, 1.

This separation must be done with the greatest care and evenness, bearing in mind that the spokes must radiate from the centre at an equal distance from each other and also must have a gradual downward curve. The winding awl will be found most helpful in the first few rows of a base, as a spoke that tends to lie above or below the other spokes can be brought into position with this tool.

As you weave, press each stroke down tight between the spokes, using the winding awl in the first few rows, and draw the weaver close to the weaving of the preceding row. By the time the third row is woven, the spokes should be evenly separated.

As you carry the weaver each time in front of two spokes and down between the spokes, with the index-finger of the right hand endeavor to give the weaver a slight curve *down and in* toward the centre, so that it will curve under the spoke rather than merely pass back of it. This curving of the weaver can only be mastered by practice, but it is essential in all weaving as it not only adds strength and beauty to the weaving but prevents the weaver from standing out from the weavers of the preceding row. Do not forget with every stroke down, in the first few rows of the base, to use your winding awl and press the weaving as close to the button as possible. As you weave, curve the base slightly downward.

Continue the Japanese weave until the diameter of the base underneath measures three and three quarters ($3\frac{3}{4}$) inches. Stop the weave at the initial spoke and turn the base over. Lace the weaver under the weaver of the preceding row that crosses the spoke and cut it off, allowing about an inch, so that it will not pull out. With a slanting cut, trim any weavers underneath that may stick out where you mended. Refer to mending of Japanese weave (26) when a new weaver is needed. Do not trim the base spokes until you are ready to weave the sides of the basket.

Make a second base and, if it proves stronger, a better curve and smoother weaving, rip the first one out, soak the weavers, and make it over. Continue this until you have six perfect bases.

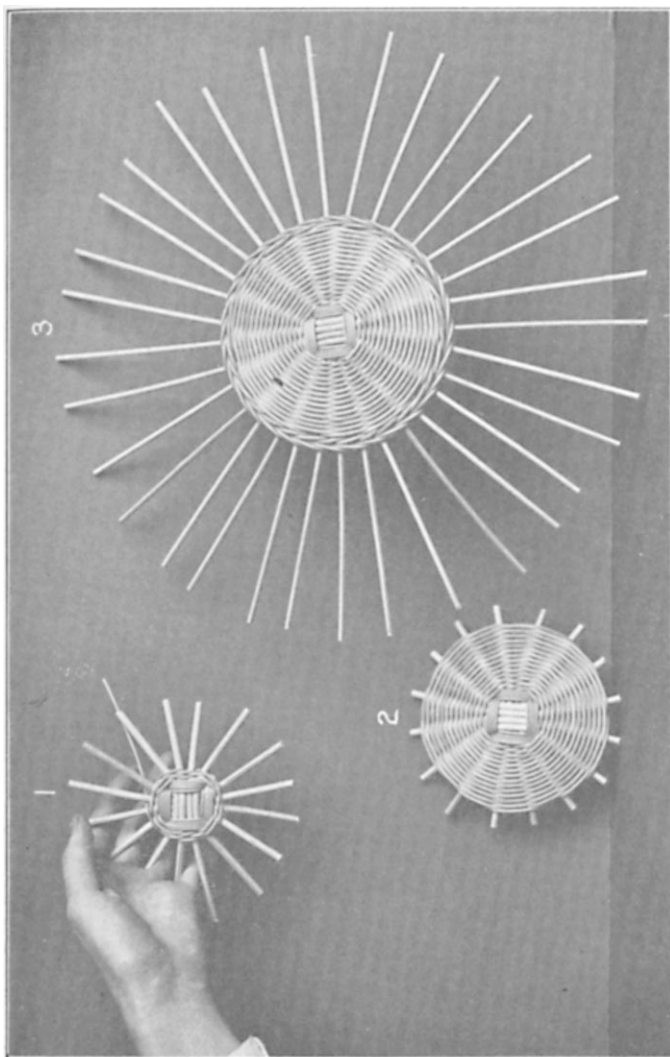

FIGURE IV. BASE

- 1.** The spokes of the base separated.
- 2.** Base weave completed.
- 3.** Side spokes separated by a three rod arrow

CHAPTER IV
WORK-BASKETS

37. WORK-BASKET I, MODEL I.

DIMENSIONS

Base.....	4 $\frac{3}{4}$ inches.
Height.....	4 inches.
Opening.....	9 $\frac{1}{2}$ inches.

MATERIALS

8 base spokes.....	No. 5 reed, 6 inches long.
Weavers.....	No. 2 reed.
32 side spokes.....	No. 4 $\frac{1}{2}$ reed, 18 inches long.
Weavers.....	No. 3 reed.

Weave base as described in paragraph on bases (34-36).

38. Soak side spokes five minutes and with a knife sharpen the ends that are to be inserted in the base with a long slanting cut of about an inch. Turn the base upside down in your lap, trim one spoke at a time of the base spokes, as close to the weaving as possible, pressing the pliers tight against the weaving as you cut. Insert two of the side spokes (No. 4 $\frac{1}{2}$) on either side of the base spoke, having first run the awl down along the spoke to open the way and push the spoke down to the button.

Should any of these spokes prove soft, reject them and replace them with hard ones, as one soft spoke in a basket may ruin a model. Continue around the base until each spoke has been bi-spoked with two spokes of No. 4½.

39. SEPARATING THE BI-SPOKES IN A BASE BY MEANS OF A THREE-ROD ARROW.

These side spokes must now be separated an equal distance apart before turning the basket. This is accomplished by a three-rod arrow (19). (See Fig. IV, 3.)

Select a soft weaver of No. 3 reed, measure the circumference of the base, allowing an inch over, double the length and cut two weavers of equal length from soft reed. These three weavers, each twice the circumference of the base, will make the arrow. Place the base with the inserted spokes on your lap with face or right side of the base up. Select any spoke and run one of the weavers close down in the weaving on the right side of the spoke, pinch it close to the weaving, and allow it to lie on the top of the base. Mark this spoke with a pencil mark or string, as it is the first or *initial spoke of the arrow*. Insert a second weaver in the same way on the right side of the spoke to the right, and the third weaver to the right of the third spoke, pinch and draw on top of base. Carry each left-hand weaver in succession in front of two spokes and under the third, allowing it to pass on top of the other two weavers. See directions for making an arrow (19), and follow them accurately, remembering as you weave to separate the spokes an equal distance apart.

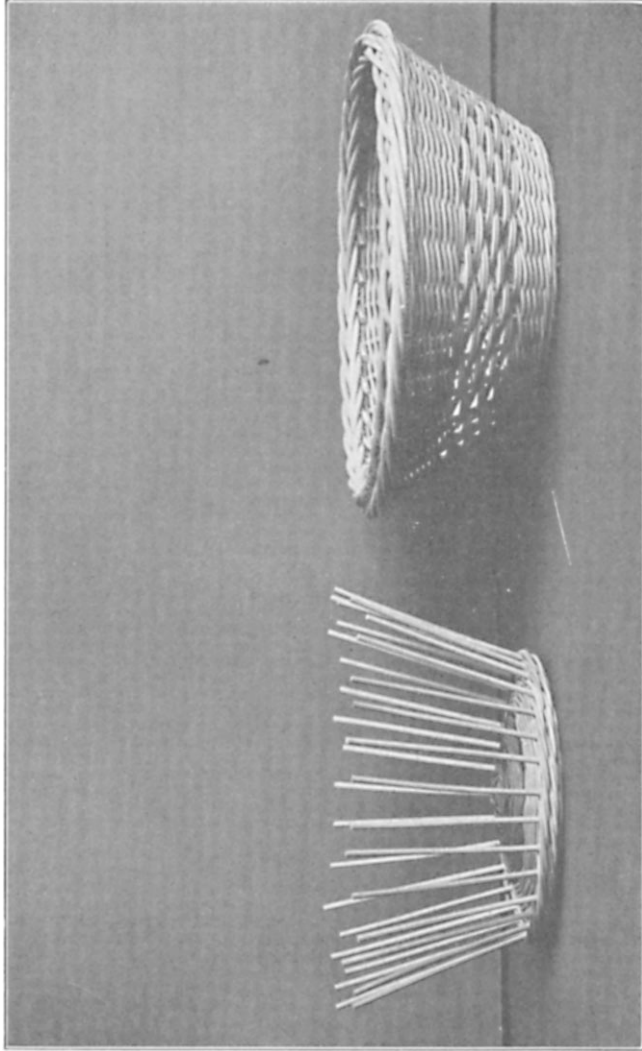

FIGURE V, MODEL I

Reverse the first arrow in the row at the initial spoke, and make the second row of the arrow with great care.

This part of the weaving will be difficult for a beginner, but must be mastered at the start as it is essential to separate the side spokes before attempting to turn the basket; trim the weavers on the wrong side with a slanting cut.

40. TURNING THE BASKET.

Turn the basket over and pinch the spokes very close to the weaving of the arrow. Select four weavers of No. 3 reed.

A basket can be turned best from the base by a four-rod coil (15*b*, 17), and, as a rule, it takes three rows of coils to turn the spokes at a right angle from the base, as in Fig. V.

Insert these four weavers at four consecutive spokes, marking the first one to the left as the *initial spoke of the basket*. Hold the base with the concave or under side toward your body. The bi-spokes are now to be turned, each one in its order, at right angles to the base. As you carry each left-hand weaver in front of three spokes and back of one, guide the direction of the three spokes so that they turn perfectly evenly and are the same distance apart, and direct them to form the same angle with the base. The turning of a basket is one of the most important features of basket weaving. Reverse the weaving at the initial spoke to complete the coil but do not lock as in a single coil, remembering that when a coil is followed by a second one the locking is omitted. Make a second and finally a

third coil, reversing each time at the initial spoke. At the end of the third coil the spokes should be turned as in Fig. V. Cut out the fourth weaver and continue in triple weave (13) for three quarters of an inch. You will notice at the initial spoke that the weavers in the first two rows of the triple weave pass immediately one on top of the other, making a slight blemish in the weaving; but it is wiser not to reverse the triple weave at the initial spoke as it tends to make a depression in the weaving at this point of the basket. Cut out the third weaver, and weave one and five eighths inches of "double Japanese weave" (11), carrying the two weavers as one. At the beginning of this weave the weaver at the initial spoke passes in front of two spokes and back of the third, while the weaver to the right of it passes over one spoke and under one, which brings the two weavers under the same spoke, and now the "Japanese weave" can be done correctly.

Finish this weave as you began, one weaver back of the initial spoke and the second to the right of it. Insert a third weaver and continue in "triple weave" (13), one and one quarter inches. Finish the top of the weaving with a four-rod locked coil (15*b*, 17-18). The diameter of the basket should measure ten and one half inches.

41. BORDER NO. 1 MADE IN THREE ROWS.

Soak the spokes and crush them very close to the weaving, and make the following border:

First Row. Take any spoke, as No. 1, and carry it to the right and back of Nos. 2 and 3 close to the weaving and to the outside of the basket. No. 2 is

brought back of Nos. 3 and 4, and so on around the basket.

Do not draw the first two spokes of the border too close, for when the circuit is being completed the last two standing spokes must lace under the first two spokes laid down and come to the outside of the basket.

Second Row. Each spoke in turn is carried in front of three of the original standing spokes and on top of the spokes to the right of it and inside of the basket, under the first row of the border, not drawing the first three spokes in this row too tight, as the last three must pass over them. This row forms a heavy coil on the outside rim of the basket and can be made to lie more evenly by running the palm of the hand around the basket. The spokes now are all on the inside of the basket.

Third Row. Carry each spoke in turn on top of the two spokes to the right and down under the third, curving the spokes in close to the basket and lacing the last two spokes in the row with the first two spokes of the third row laid down. Be careful in finishing this row not to confuse the last two strokes with any of the strokes in the first row. To make it easier insert your awl or a little piece of reed back of the first stroke in this third row as a mark, when you come to lace in the last two spokes.

The diameter of your basket should now measure about nine and one half inches.

Trim each spoke neatly with a slanting cut on the right-hand side of the spoke it passed under in the third row.

42. In weaving great care must be taken to keep the spokes in correct position, in reference to the base and each other. This is a most difficult part of basket weaving and can only be acquired by close attention to the two rules following:

First. The spokes must all have the same slope from the base; as each spoke comes into play see that it does not push in or bend out farther than the spokes on either side of it.

Second. Keep the spokes an equal distance from each other.

Continue to produce this model until you have a firm basket, with straight spokes, even weaving, and the specified measurements.

This model may be reproduced in a smaller size by using a smaller base.

43. WORK-BASKET, MODEL NO. 2.

DIMENSIONS

Base.....	5 $\frac{3}{4}$ inches.
Height.....	3 $\frac{1}{2}$ inches.
Opening.....	9 $\frac{1}{2}$ inches.

MATERIALS

8 base spokes.....	No. 5 reed, 7 inches long.
Weavers.....	No. 2 reed.
32 side spokes.....	No. 4 $\frac{1}{2}$ reed, 18 inches long.
Weavers.....	Nos. 2 and 3 reed.

Weaving. Four-spoke base (34-36) five and three quarters inches.

Bi-spoke with thirty-two side spokes (38), and separated with a three-rod arrow (39).

Pinch and turn with two rows of a four-rod coil (40).

Three rows of triple weave (13).

Six rows of over-and-under weave (8*b*), using two weavers as the number of spokes is even.

Four-rod arrow (19-20*d*).

One inch of double over-and-under weave (8*b*), using four weavers of No. 2 reed.

And finish with a four-rod coil locked (15*b*, 17-18).

Border No. 1 (41).

See Work-Basket No. 1.

44. BOWL-SHAPED BASKET, MODEL NO. 3.

Base.....4 inches.

Height.....4 inches.

Opening.....8 inches.

Diameter.....9 inches.

Do not pinch the spokes at the base but make a gradual curve from the base like a bowl, until your diameter is nine inches, then curve inward until the diameter is eight inches.

Select your own weaves.

45. QUESTIONS.

One. What part of the weaving is designated by the term "Button"?

Two. Holding the base spokes in the first position, that is, needles parallel to the body, which spoke becomes the initial spoke of the base? Is it a needle or one of the threads?

Three. Of what use is the arrow in the base?

Four. What does bi-spoking mean?

Five. What is the difference between a three-rod coil and triple weave?

Six. What two distinct features in weaving determine a coil?

Seven. When a coil is followed immediately by a second one, what part of the weaving of a coil is omitted?

Eight. What is the long stroke in "Japanese weave"?

Nine. Describe how "double Japanese weave" is begun?

Ten. What two fundamental principles of weaving characterize the position of the spokes in a basket?

CHAPTER V

BASKETS WITH SIMPLE HANDLES

Rule. Baskets with handles must always be made on an even number of spokes.

46. MODEL No. 4. BOWL-SHAPED BASKET, WOUND HANDLE.

DIMENSIONS

Base.....	4 $\frac{1}{4}$ inches.
Height.....	4 $\frac{1}{4}$ inches.
Opening.....	8 $\frac{1}{2}$ inches.

From coil at base to coil at border four and a half inches (by tape measure).

MATERIALS

8 base spokes.....	No. 5 reed, 6 inches long.
Weavers.....	No. 2 reed.
32 side spokes.....	No. 4 $\frac{1}{2}$ reed, 16 inches long.
Weavers.....	No. 3 reed.

Weave base as directed in lesson No. 1 (34-36), sharpen the side spokes and insert in the base, separating them with a three-rod arrow on the right side of the base (39).

In turning this basket at the base the side spokes are not crushed, as in the previous models, but are turned gradually, making what is known in basketry as a bowl-shaped turn, the same as the turn in basket No. 3 of the second lesson (44).

Turn the base face downward and make a four-rod coil (locked) of No. 3, turning each spoke as you pass over it slightly upward. This coil gives the basket something to rest on and helps to direct the spokes into the correct slope from the base.

Weaving the Basket. Proceed with one and one half inches of "over-and-under weave," using No. 3 reed (use two weavers always on an even number of spokes, (8 B); one and one half inches of "double Japanese" (11), using No. 3 reed; one and one half inches of "triple weave," using No. 3 reed; finish with a four-rod locked coil, using No. 3 reed (15b, 18).

Border. Crush the spokes (41). *First row* back of two spokes and out, *second row* in front of three and in under first row, *third row* over two spokes and down.

47. HANDLE. The handles given in this lesson are very simple and used only on small baskets, but if a beginner masters them and understands the principle, the more elaborate ones will be acquired with greater ease. There are three essential points to be considered in the handles:

(a) The size of the handle-bar must correspond with the size of the basket.

(b) The height of the handle must correspond with the height of the basket.

(c) The two ends of the handle-bar must be inserted at two spokes in the basket that are exactly opposite each other; and these two spokes must be one or other of the two side spokes inserted between the two middle needles in the base or the two middle threads.

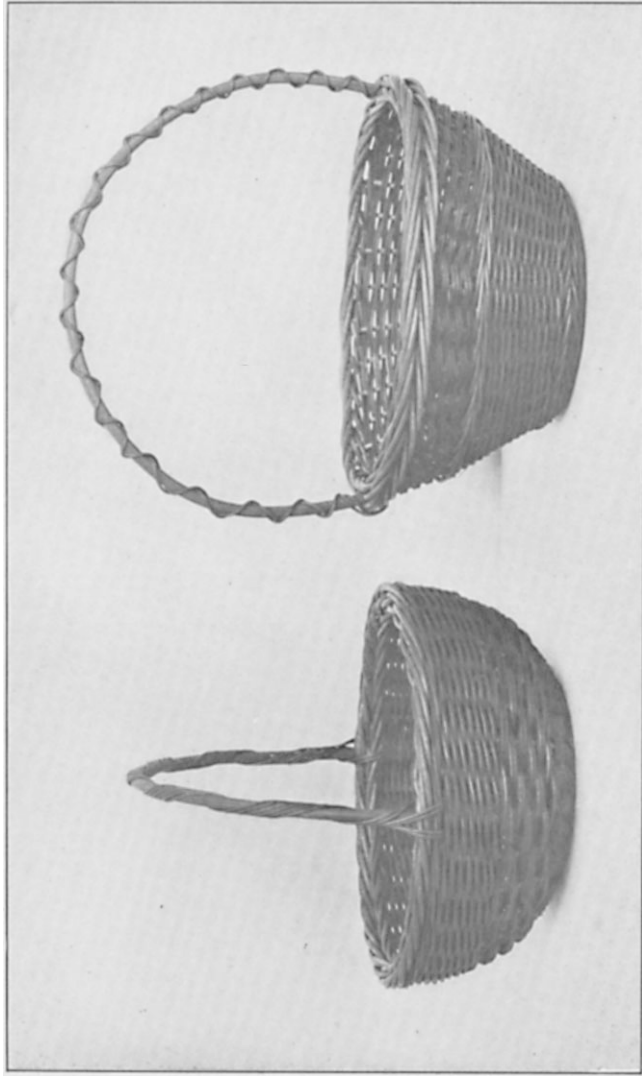

FIGURE VI, MODELS 4 AND 5

48. MATERIALS.

Handle-bar.....No. 8 reed, 21 inches long.
 Weavers.....No. 3 reed.

With a long stroke of the knife cut one side of the end of the handle-bar into a point about two inches long, making it perfectly smooth. Cut the other end in the same manner, taking care to pare both ends on the same side of the bar.

Insert these ends down beside the spokes selected in the basket, previously opening the way with an awl. Press the bar down two and a half inches between the weaving; the other end of the bar is inserted in the same way beside a spoke exactly opposite the spoke at which the first one was placed. This makes the foundation handle.

49. Select a pliable weaver of No. 3 reed and with it measure the height of the handle-bar from border to border, allowing two inches over. Take three times this length for one weaver and cut a second one.

(a) Insert these two weavers under the coil at the top of the basket, and to the right of the spoke holding the handle-bar, and draw these two ends through to the inside of the basket for at least two inches. Carry them back of the handle-bar to the left and under the coil to the outside of the basket, and in front of the next spoke to the left to the inside of the basket, and trim the ends off. This fastens the ends of the weavers and must always be done before attempting to wind the handle.

(b-1) Take up the two long weavers on the out-

side of the basket and carry them to the left up over the border across the handle-bar and wind them around the bar at regular intervals about two and a half inches apart. On reaching the other side, insert the two weavers under the coil on the outside of the basket to the right of the handle-bar and draw them through to the inside of the basket.

(*b-2*) Bring the two weavers up on the right side of the bar and curve them around the bar, allowing the weaver to the right to turn downward and lie close to the first row of winding on the handle-bar just completed; the weaver to the left must lie close to the right one and above it. Carry these weavers back over the bar to the other side as close to the first winding as possible. On reaching the other side where the winding started, instead of taking the weavers to the right of the bar insert them under the coil and to the left of the handle-bar and then draw them through to the inside of the basket. This gives two pairs of weavers, one on each side of the bar.

(*b-3*) Carry the weavers, now on the inside of the basket, back of the handle-bar and up on the right side of the bar, and bring them to the outside of the bar, curving the weavers down to meet the winding already on the bar, so that the weaver to the right falls next to the winding on the bar, and the left one is close to it and above it. On reaching the other side, carry the weavers under the coil and to the left of the handle-bar, and draw them through to the inside of the basket and fasten these ends as in the beginning of the winding, by taking them to the right, back of the bar, and to the outside of the

basket under the coil, and in and out over one or two spokes to the right.

50. Before the reed dries out, singe the ends over a lamp or gas-stove, being careful not to hold the basket too close.

51. MODEL NO. 5, JAPANESE HANDLE.

DIMENSIONS

Base.....	4 $\frac{1}{4}$ inches.
Height.....	4 $\frac{1}{2}$ inches.
Opening.....	9 $\frac{1}{4}$ inches.

MATERIALS

- 8 base spokes.....No. 5 reed, 6 inches long.
- Weavers.....No. 2 reed.
- 32 side spokes.....No. 4 $\frac{1}{2}$ reed, 15 inches long.
- Weavers.....No. 3 reed.

Weave base as directed in lesson No. 1 (34-36), separate side spokes with three-rod arrow (39). Crush spokes and turn directly up with three rows of four-rod coils (40), remembering that a coil followed immediately by another one is not locked. In the fourth row carry the weavers under instead of over the weavers following, thus making an arrow with the third coil (19). Lace the weaving at the initial spoke to complete the arrow.

Cut out three of the weavers, and with one weaver at the initial spoke, weave two inches of the "single Japanese weave" (10); at this point the diameter should measure seven and one half inches. Measure the circumference and take four weavers

of No. 3, twice this length, and make a four-rod arrow (19-20*d*), weave one and one fourth inches of "double over-and-under weave" (9), carrying four weavers, two as one, as the spokes are of even number.

Complete the basket with a four-rod coil (19-20) of No. 4½ reed.

52. BORDER No. 2.

Crush the spokes, *first row* in front of three spokes, and in; *second row* over two spokes and down.

53. JAPANESE HANDLE.

See directions for handle under model No. 4 for preparing the handle-bar (47).

Select a pliable weaver and measure twice the height of the handle from border to border, allowing fully eight inches over. Crush the middle point in this weaver, and from the inside of the basket draw one end to the outside under the coil to the right of the bar, and the other end to the outside under the coil to the left of the bar. Draw the two ends tight so that the crushed part lies close to the bar. Cross these weavers, carrying the right-hand one over the border to the left of the bar, and likewise the left-hand one to the right. Crossing these back of the bar, bring them to the top and under again, and so on at equal intervals to the other side of the basket. Take them on the outside of the border and under the coil to the inside, where they are crossed underneath the inside coil and fastened off by bringing each end out across a spoke and inside the basket, where the ends are trimmed.

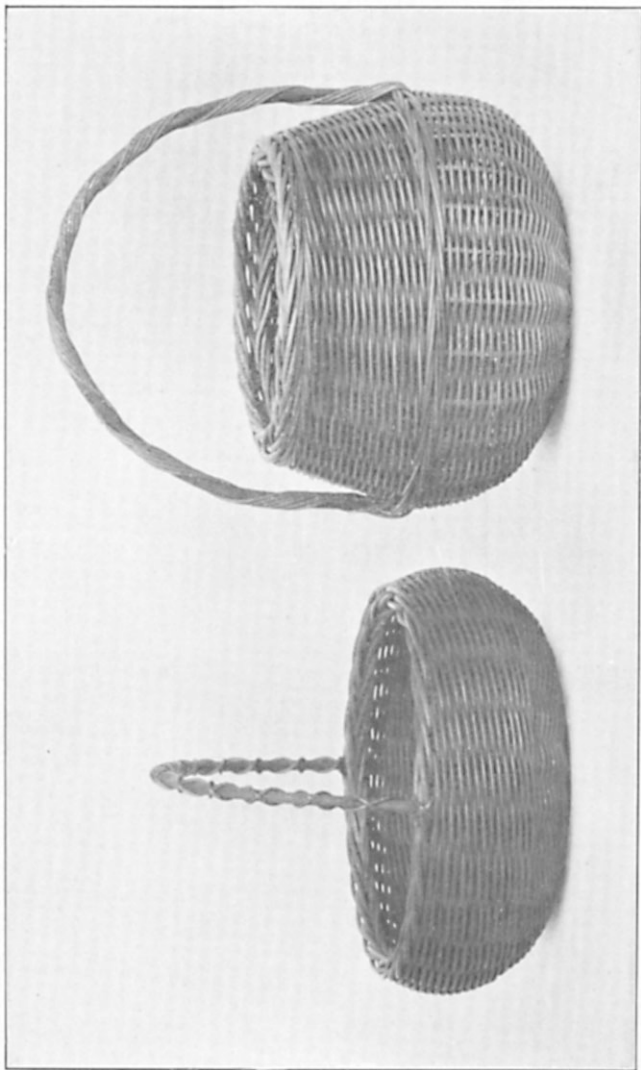

FIGURE VII, MODELS 6 AND 7

54. FIG. VII, MODELS 6 AND 7.

The two models in Fig. VII are given without the measurements. The students are to reproduce them proportionately, choosing their own measurements.

55. QUESTIONS.

Eleven. What constitutes a four-spoke base?

Twelve. Can a handle basket be made on an odd number of spokes?

Thirteen. Give the reason for your answer to question twelve.

CHAPTER VI

LILY-SHAPE FLOWER BASKETS WITH HANDLES

56. FIGURE VIII, MODEL NO. 8.

This lesson demonstrates how a model may be varied by the use of different weaves.

57. NEW PROPOSITIONS.

No. 1. Base with thirteen spokes.

No. 2. Colonial weave.

No. 3. Bellefonte weave.

No. 4. Two-ply weave.

58. BASE WITH THIRTEEN SPOKES.

Thread three spokes with three needles.

Make a button of three winds.

Pare an extra spoke three fourths the length of the other ones to a point and insert it between two of the threads, well down into the button, not allowing it to pass beyond the opposite edge of the button. Separate these thirteen spokes an equal distance apart, using the "Japanese weave" (10).

59. COLONIAL WEAVE.

In front of two spokes and back of two spokes; one weaver.

This weave can be used in baskets where the number of spokes, when divided by four, leaves a

remainder of 2 (*i. e.*, 18, 22, 26, 30, 34, 38, etc.). Change the weave by passing under one spoke; this is done as follows: Weave over two and back of two until there are two strokes over every two sets of spokes. Then change the weave by bringing the weaver under one spoke instead of two spokes, and

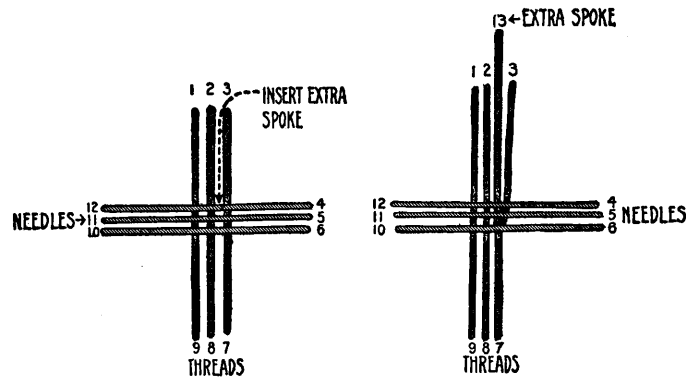

DIAGRAM O. BASE WITH THIRTEEN SPOKES

proceed as before, over two spokes and back of two spokes, changing each time when the point is reached where three strokes would pass over any two spokes, if such change were not made.

Explanation, 10 Spokes

Row 1. Start with weaver back of spoke No. 1, pass weaver over Nos. 2 and 3, under Nos. 4 and 5, over Nos. 6 and 7, under Nos. 8 and 9, and over Nos. 10 and 1.

Row 2. Pass weaver under Nos. 2 and 3, and over Nos. 4 and 5, under Nos. 6 and 7, over Nos. 8 and 9, under Nos. 10 and 1.

Row 3. Pass weaver over Nos. 2 and 3, under Nos. 4 and 5, over Nos. 6 and 7, under Nos. 8 and 9, over Nos. 10 and 1.

Row 4. Pass weaver under Nos. 2 and 3, over Nos. 4 and 5, under Nos. 6 and 7, over Nos. 8 and 9, and under No. 10 *only*.

This changes the weave in row No. 5 to—over Nos. 1 and 2, under Nos. 3 and 4, over Nos. 5 and 6, etc. Keep the basket damp, and press the weaving down, giving it a kink.

60. MENDING COLONIAL WEAVE.

Allow the short weaver to end back of a spoke on the inside of the basket; holding it away from the spoke, draw the new weaver from the inside of the basket to the outside, splicing it with the old weaver and carrying it back of the mending spoke and the one to the right, following the line the old weaver naturally would have taken. Trim the new weavers on the outside of the basket with a slanting stroke close to the left of the mending spoke.

61. BELLEFONTE WEAVE.

In front of one spoke and back of three; one weaver.

This weave can be used in baskets where the number of spokes when divided by four will leave a remainder of two (*i. e.*, 18, 22, 26, 30, 34, 38, etc.).

Explanation: Every other spoke is left out of the weaving. This weave should be used only for bands not more than three inches in width. The spokes that are left out must be picked up by a four-rod arrow or coil (19-20d, 15-18).

Mend as in "over-and-under weave" (23).

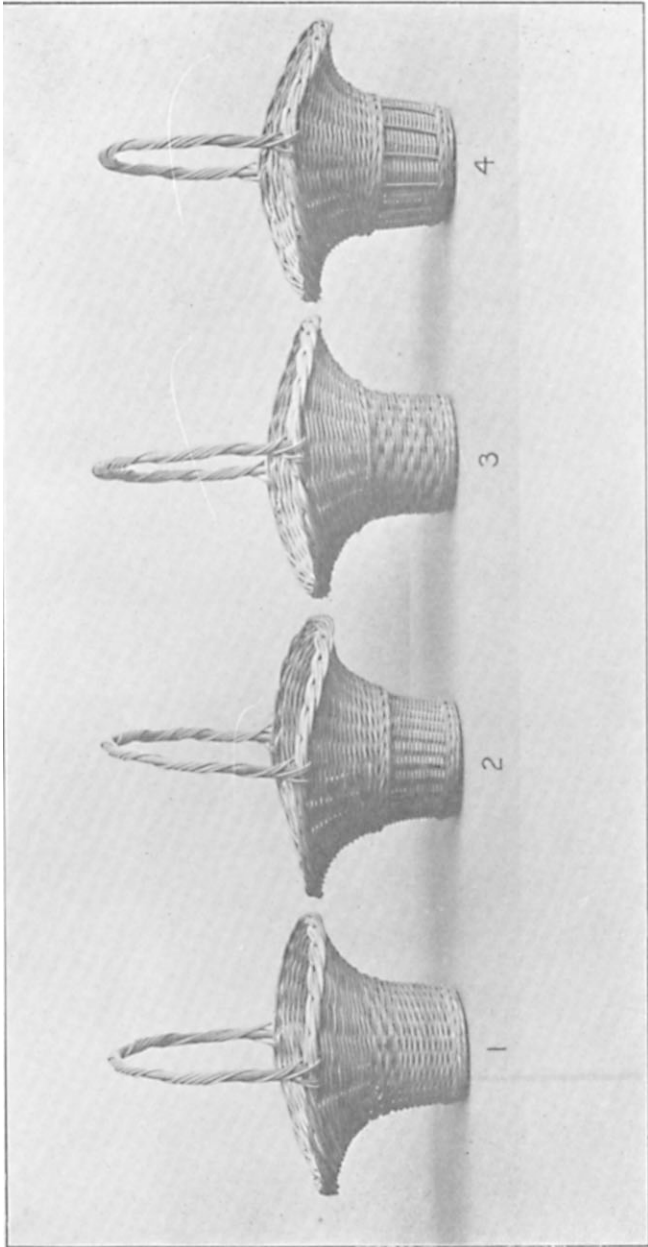

FIGURE VIII, MODEL 8

62. TWO-PLY WEAVE.

In front of two spokes and back of two spokes; four weavers.

This weave can be used in baskets with any number of spokes.

Explanation: Four weavers are inserted back of four consecutive spokes, each in turn carried over two spokes, and back of two spokes.

Mend as in "triple weave," hiding the ends (28).

63. There are two important things to be remembered in weaving baskets with handles:

(a) All baskets requiring handles must be woven on an even number of spokes, so that there are the same number on either side of the basket between the two spokes exactly opposite each other, where the handle-bar is inserted.

(b) The handle-bar must be inserted in the basket along the spoke that runs from the middle needle or middle thread of the button in the base and not from the corners of the button.

64. MODEL NO. 8.

DIMENSIONS

Base.....	3½ inches.
Height.....	6 inches.
Opening.....	9½ inches.

MATERIALS

6 base spokes, No. 5 reed (or a 3-spoke base), 5 inches long.

1 base spoke, No. 5 reed (and 1 extra spoke), 4 inches long.

26 side spokes, No. 4½ reed, 20 inches long.

Weavers, Nos. 2, 3, and $3\frac{1}{2}$ reed.
Handle-bar, No. 10 reed, 24 inches long.

Basket weavers endeavor as far as possible to have in round models twice as many side spokes in a basket as there are base spokes, in order that each spoke may be bi-spoked.

The model used in Fig. VIII is woven on twenty-six side spokes, and a three-spoke base, with one extra spoke inserted in the button to give thirteen base spokes.

Cup the base with the usual downward slope. Trim the base spokes, one at a time close to the weaving, and insert the twenty-six side spokes, bi-spoking each base spoke, having previously sharpened the side spokes as directed in lesson on Work-Basket No. 1 (38).

Crush the side spokes close to the weaving and omit separating them with an arrow as in the previous lessons. Turn the side spokes directly at right angles to the base, using four rows of a four-rod coil and making an arrow of the last coil (51). Each basket in Fig. VIII is turned in this same manner with No. 3 reed.

65. BASKET NO. 1.

Weave in "single Japanese weave" (10) with No. 3 reed, until basket measures two inches from base.

Weave in "double Japanese weave" (11) with No. 3 reed, until the basket measures three and one half inches from base.

Weave in "two-ply weave" (62) with No. $3\frac{1}{2}$ reed, until basket measures six inches from base.

66. BASKET No. 2.

Weave in "over-and-under weave" (8*b*) with No. 3 reed, until the basket measures two and one half inches from base.

Weave a "four-rod arrow" (19-20*d*) No. 3½ reed.

Weave in "two-ply weave" (62) No. 3½ reed, until the basket measures six inches from base.

67. BASKET No. 3.

Weave in "colonial weave" (59) No. 3 reed, until basket measures three inches from base.

Weave a "four-rod coil" (15*b*-18) No. 3½ reed.

Weave in "two-ply weave" (62) No. 3½ reed, until the basket measures six inches from the base.

68. BASKET No. 4.

Weave in "Bellefonte weave" (61) No. 3 reed, until the basket measures two and three quarters inches from the base.

Weave a "four-rod arrow" (19-20*d*) No. 3½ reed.

Weave in "two-ply weave" (62) No. 3½ reed, until the basket measures six inches from the base.

69. Each basket in model 8 measures five inches in diameter at the beginning of the "two-ply weave." From this point in the weaving the basket must be woven out gradually like a lily so that when the height measures (with a tape measure) six inches from the base to the top of the weaving, the diameter of the opening is nine and one half inches.

70. COMMERCIAL BORDER No. 1.

Wet the spokes and crush them close to the weaving.

DIAGRAM NO. 1.

1. LAY DOWN TWO SPOKES.

(a) Select any spoke (No. 1) and carry it back of the next spoke to the right, and to the outside of the basket, holding it with the left hand.

(b) Lay the next spoke (No. 2) allowing it to pass back of the spoke to its right, and to the outside of the basket. Two spokes are now laid down.

DIAGRAM NO. 2.

2. (a) Carry the first laid-down spoke (No. 1) in front of the first standing spoke (No. 3) to the right, and

(b) across the second laid-down spoke (No. 2), and

(c) back of the second standing spoke (No. 4) to the outside of the basket,

(d) holding these two laid-down spokes (Nos. 1 and 2) with the left hand.

With the right hand bring the first spoke now standing (No. 3) back of the next standing spoke (No. 4), and to the outside of the basket, allowing it to lie parallel, and close to the laid-down spoke (No. 1) previously carried back of this spoke (No. 4); in other words, the third spoke has been laid down.

At this point of the border there is a single laid-down spoke (No. 2) passing to the outside and in front of the now first standing spoke (No. 4), and a double set of laid-down spokes (Nos. 1 and 3) passing to the outside in front of the now second standing spoke (No. 5).

The two standing spokes to the right will be termed first and second spokes throughout the border.

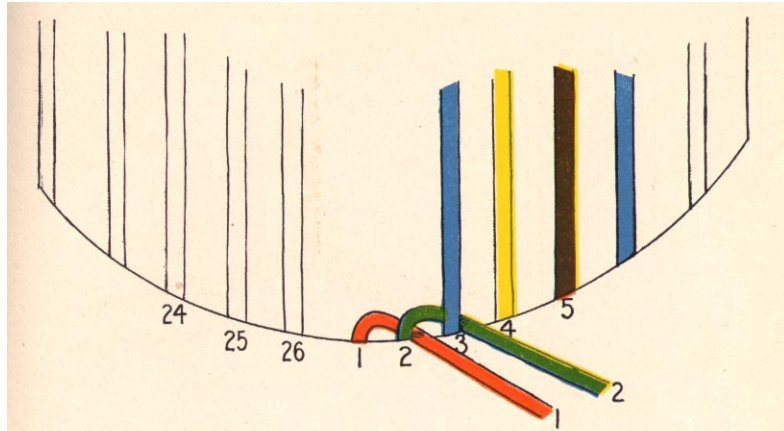

DIAGRAM NO. 1

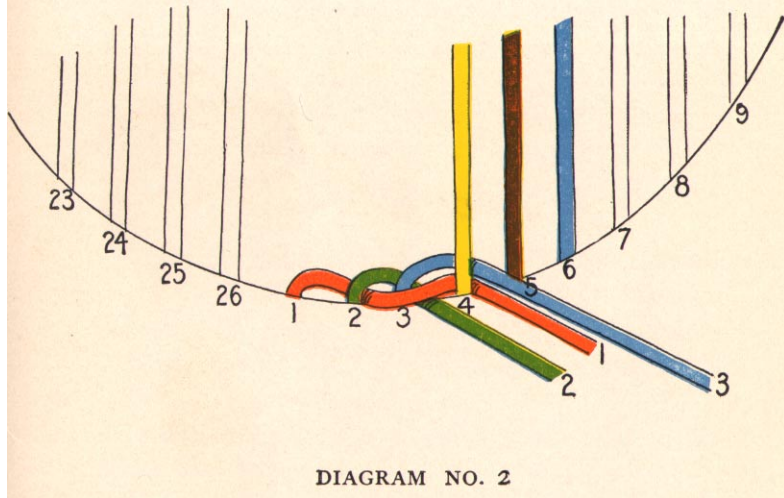

DIAGRAM NO. 2

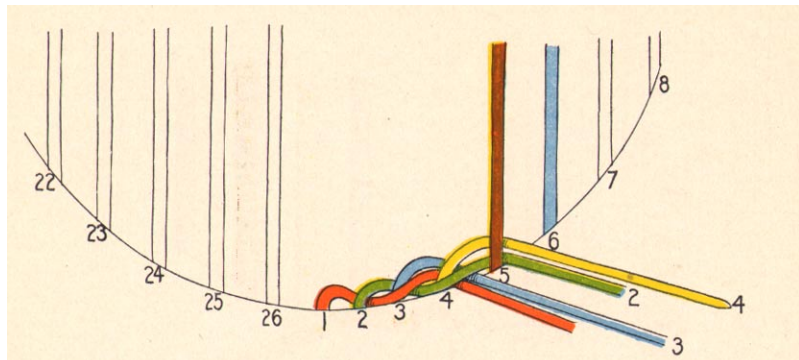

DIAGRAM NO. 3



DIAGRAM NO. 4

DIAGRAM No. 3.

3. (a) Carry the single laid-down spoke (No. 2) in front of the first standing spoke (No. 4), and

(b) across the double set of laid-down spokes (Nos. 1 and 3), and

(c) back of the second standing spoke (No. 5), and to the outside of the basket.

(d) Lay down the first standing spoke (No. 4), *i. e.*, bring No. 4 back of 5 to the outside, parallel with No. 2.

There are now two double sets of laid-down spokes on the outside of the basket, each set made up of a long and a short spoke, with the longer to the right of the shorter one.

DIAGRAM No. 4.

4. (a) Carry the longer laid-down spoke of the first set (No. 3), in front of the first standing spoke (No. 5), and

(b) across the second double set of laid-down spokes (Nos. 2 and 4), and,

(c) back of the second standing spoke (No. 6) to the outside, and

(d) lay the first standing spoke (No. 5) parallel with it.

(e) Bring the longer laid-down spoke of the second set (No. 4), in front of the first standing spoke (No. 6)

(f) back of the second standing spoke (No. 7) and out, and

(g) lay the first standing spoke (No. 6) parallel with it.

There are now two single laid-down spokes and two double sets of laid-down spokes passing to the outside of the basket.

General Rule. Continue around the basket, each time carrying the longer left-hand laid-down spoke

(1) in front of the first standing spoke to the right,

(2) across a double set of laid-down spokes,

(3) back of the next standing spoke to the right and out.

(4) Lay the first standing spoke parallel with it.

Pay no attention to the shorter laid-down spokes on this first row of the border.

DIAGRAM No. 5.

j. COMPLETION OF THE FIRST ROW OF BORDER.

When the beginning of the border is reached and only one standing spoke remains:

(a) Carry the longer laid-down spoke (No. 24) in front of this last standing spoke (No. 26),

(b) across the last set of double spokes (Nos. 23 and 25) and,

(c) back and out, under the first spoke (No. 1), which was the first laid-down spoke of the border.

DIAGRAM No. 6.

6. Carry the last standing spoke (No. 26) back and from the inside out under the first laid-down spoke (No. 1) and parallel with the spoke (No. 24) just drawn under spoke (No. 1) and to the outside of the basket. The last standing spoke has now been laid down.

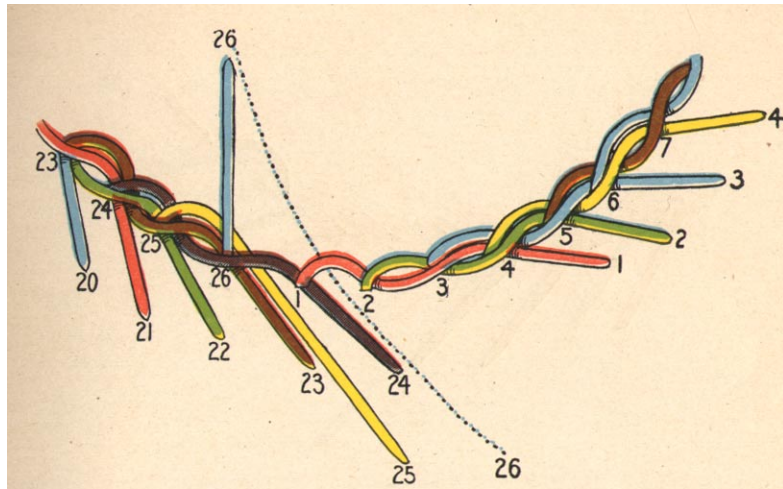

DIAGRAM NO. 5

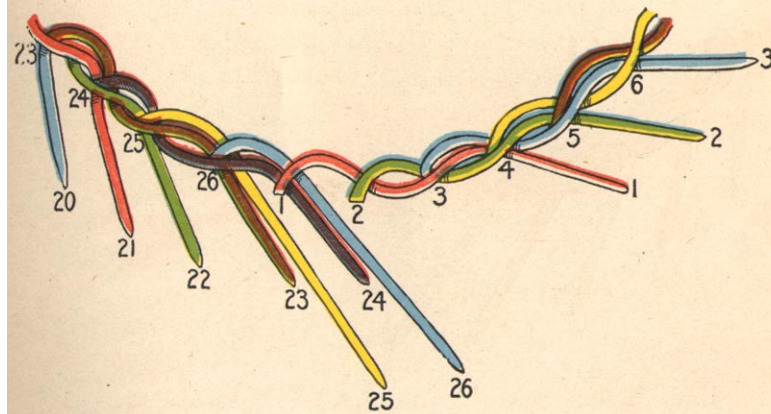

DIAGRAM NO. 6

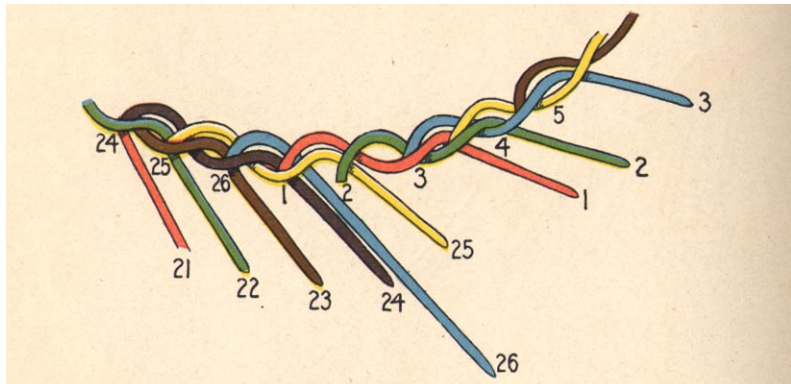

DIAGRAM NO. 7

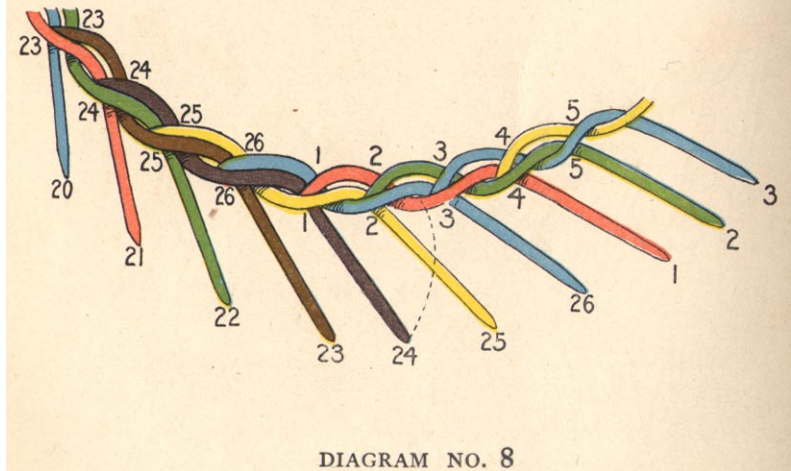

DIAGRAM NO. 8

There are now two double sets of spokes on the outside of the basket, Nos. 23 and 25 and 24 and 26.

DIAGRAM No. 7.

7. The two longer spokes in each set must be carried in turn in front of the spokes to the right (which is now a laid-down spoke instead of a standing spoke) and back of the next laid-down spoke to the outside of the basket.

Caution. These spokes must be parallel with the already laid-down spokes and not cross them.

(a) Carry the longer left-hand laid-down spoke (No. 25) in front of the first laid-down spoke of the border (No. 1) and

(b) across the last double set of laid-down spokes (Nos. 24 and 26).

(c) With the winding awl push spoke (No. 1) away from spoke (No. 2), and carry spoke (No. 25) *in* and *back* of spoke (No. 2), and to the outside, so that it lies parallel with and in front of spoke (No. 1) but does not cross it.

DIAGRAM No. 8.

8. (a) Carry the remaining longer laid-down spoke (No. 26) in front of spoke (No. 2),

(b) across the two spokes (Nos. 25 and 1) which pass back of spoke (No. 2), and

(c) with the winding awl push spoke (No. 2) away from (No. 3) and carry spoke (No. 26) *in* and *back* of spoke (No. 3), and to the outside, so that it lies parallel with and in front of spoke (No. 2) but does not cross it.

This completes the first row of the border, but to make it more effective and stronger we carry these short spokes to the inside of the basket.

DIAGRAM No. 9.

9. Bring each spoke in turn in front of one spoke to the right and back of a second spoke to the inside of the basket, making it lie parallel and in front of the two spokes already passing back of this second spoke.

To accomplish this, with the awl make an opening for the spoke to pass through between the spokes that fell back of the second spoke and one spoke that fell in front of it.

Trim the spokes carried inside the basket with a slanting cut, which completes the border.

71. HANDLE.

To place the handle correctly in a basket woven from a base composed of thirteen spokes, turn the basket upside down and select the side spoke to the left of the extra spoke inserted in the button.

Trace it to the border of the basket and insert one end of the handle-bar (previously sharpened to a point and flattened on one side) along the left-hand side of this spoke, two and a half inches down in the weaving. To locate the spoke directly opposite this one, select the side spoke at the right of the middle thread that comes from the side of the button containing the three threads and trace this to the border.

Insert the other end of the handle-bar along its left side. There will be twelve spokes on each side

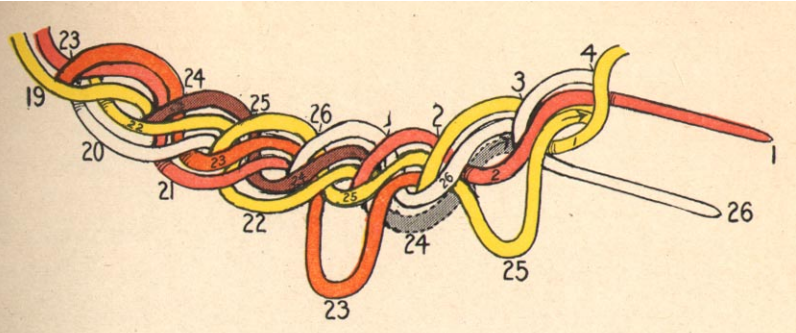

DIAGRAM NO. 9

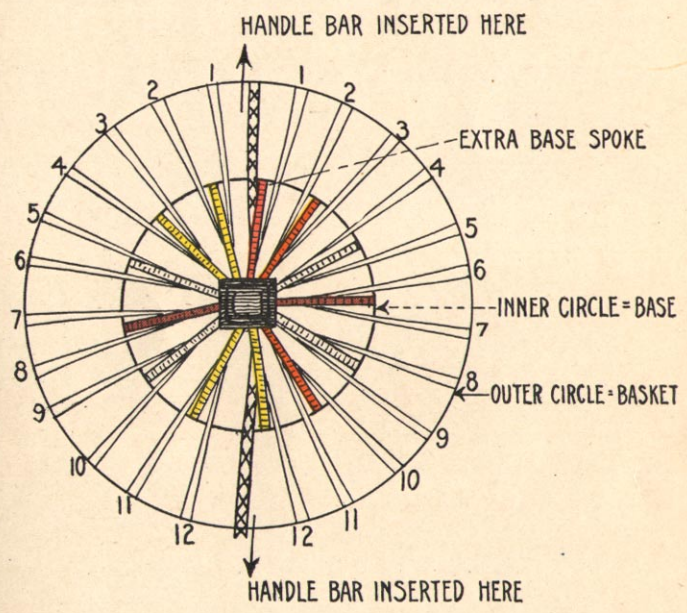

DIAGRAM NO. 10. HANDLE-BAR

of the basket between the two spokes holding the handle-bar.

See Model No. 4 (49), for winding the handle.

DIAGRAM NO. 10, HANDLE-BAR.

72. QUESTIONS.

Fourteen. How many spokes, of the total number of spokes used, come into play in the "Belle-fonte weave"? What is the weave?

Fifteen. Why is it better to insert the extra spoke in a base containing thirteen spokes among the threads rather than the needles?

Sixteen. In "commercial border" (No. 1) give the four distinct strokes that each spoke undergoes in making the border.

Seventeen. If one end of a handle-bar in a basket made on a thirteen-spoke base is inserted along the side spoke which leads from the right of the left-hand middle thread (on the side of the button containing the four threads), state what spoke leading from base spoke the other end of the handle-bar should be inserted along.

CHAPTER VII

FLOWER BASKETS

73. Baskets in Fig. IX demonstrate the variations possible in one model by the use of a graduated scale of measurements.

Each basket is turned with three rows of a four-rod coil (15*b*, 18), using No. 3 reed and making an arrow with the fourth row.

75. SPLIT HANDLE.

A split handle consists of two handle-bars of equal length which lie close together across the top but separate as they pass into the basket on either side.

Insert the sharpened ends of the two bars along the side spokes leading from the middle needles or threads of the base. Allow two side spokes between the two spokes carrying the handle-bars. Insert the other ends of the two bars alongside spokes directly opposite these, being careful to have the two bars perfectly parallel and each bar measuring the same from the border on one side of the basket up and over to the border on the opposite side.

Wet a piece of twine or raffia and tie the two handles firmly in two places where the bars come together.

FLOWER BASKETS

74. MEASUREMENTS OF FLOWER BASKETS, FIGURE IX

MODEL NO.	NO. OF BASE SPOKES	SIDE SPOKES		FINISHED MEASUREMENTS	WEAVING	BORDER	HANDLE
		NO.	LENGTH				
9	Three threaded through 3, one extra. Or total, 13.	26	20	Base 3½ inches. Height 6 inches. Opening 9½ inches.	Single Japanese, 2 inches. Four-rod arrow. Two-ply, 3 inches.	Commercial, No. 1.	Single 24 inches. No. 10 reed.
10	Three threaded through 3, one extra. Or total, 13.	26	21	Base 3½ inches. Height 7 inches. Opening 11 inches.	Single Japanese, 2½ inches. Four-rod arrow. Two-ply, 3½ inches.	Commercial, No. 1.	Split 27 inches. No. 10 reed.
11	Four threaded through 3. Or total, 14.	28	22	Base 4 inches. Height, 8 inches. Opening 12½ inches.	Single Japanese, 3 inches. Four-rod arrow. Two-ply, 4 inches.	Commercial, No. 2.	Split 30 inches. No. 11 reed.
12	Four threaded through 4. Or total, 16.	32	23	Base 4 inches. Height 9 inches. Opening 14 inches.	Single Japanese, 3½ inches. Four-rod arrow. Two-ply, 4½ inches.	Commercial, No. 2.	Split 35 inches. No. 11 reed.

76. WINDING A SPLIT HANDLE.

(A) Measure off four weavers of No. 3 reed, each one fully three times the length of the handle-bar used. Insert two of them from the outside, under

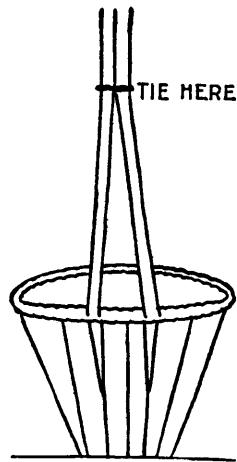

DIAGRAM NO. II.
INSERTING SPLIT
HANDLE-BARS

the border on the right-hand side of the spoke carrying the right handle-bar. Draw these to the inside of the basket merely long enough to carry them back of the handle-bar, then to the outside of the basket under the border, over one spoke to the left and then in. Trim with a good slanting cut. The ends are thus held firmly and will not pull out.

(B) *The winding* of a split handle will become very clear if strict attention is paid to the following rule: start the wind of both bars on the right-hand side of the bar. There are three distinct steps.

(C-1) Going over the first time pass in on the opposite side under the border on the *right* side of the handle-bar.

(C-2) Coming back pass in on the *left* side.

(C-3) Going over the second time, pass into the *left* and end.

The two weavers are used as one, always keeping them parallel and close to each other.

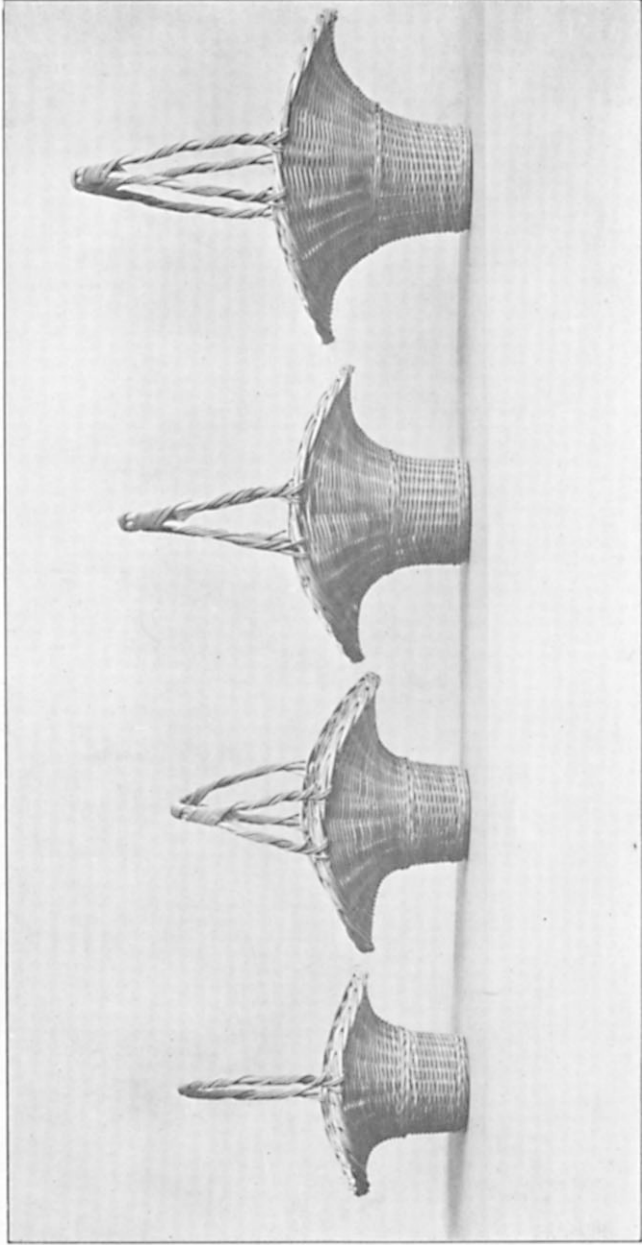

FIGURE IX, MODELS 9, 10, 11, AND 12

77. WINDING OF THE FIRST HANDLE-BAR IN A SPLIT HANDLE.

That is, the Bar to the Right

Explanation of No. 1

Carry the long ends up over the border to the left and curve them around the handle-bar, making two winds on the single part of the handle-bar at either end, and three winds where the bars lie together.

On reaching the other side of the basket, carry the weavers down the single part of the same bar upon which you started the winding, noticing that the handle-bar to the right on the side where you began the winding becomes the left handle-bar on the opposite side of the basket. Crossing on top of the border, pass in under it, to the right-hand side of the bar. Draw the weavers directly through to the inside of the basket and *up* on the right-hand side of the handle-bar.

Explanation of No. 2

Carry them in front of the handle-bar, curving the right-hand weaver close down to the first winding. Take the weavers back across the handle-bar, making them follow the curves of the first winding, and be parallel with it.

On reaching the other side, *i. e.*, the starting-point, draw the weavers under the border to the inside of the basket, this time on the left-hand side of the handle-bar.

Explanation of No. 3

Carry them back of the handle-bar and up on the right-hand side of it. Curve them across the front

of the handle-bar, being careful, as before, to make the weaver to the right fall close to the previous windings on the bar. This gives the weavers the proper twist, and makes them lie much closer to the other windings than if you allow the left-hand weaver at this point to fall in next to the previous set of windings. Carry the weavers across the handle-bar to the other side, passing in, under the border, on the left side of the handle-bar, and fasten the ends as in the beginning, by drawing them back under the spoke holding the bar, to the outside, over a spoke to the right, and in, and trim with a slanting cut. This completes the winding of the first handle-bar.

78. WINDING OF THE SECOND HANDLE-BAR IN A SPLIT HANDLE.

That is, the Bar to the Left

The second handle-bar is wound in a similar manner to the first. Fasten the short ends, and with the long ends make two winds on either end of the single part of the bar.

On reaching the three winds on the double bar, instead of allowing the weavers to lie close to the first set of windings, allow sufficient space the first time the weavers are carried over for two weavers to lie between the original windings and the ones being carried across. Coming back, the weavers fill up this space, and going over the last time they fall to the right of the first winding of the second bar. The rule for the second bar is the same as the first one (76c).

In going over the first time, pass in under the bor-

der on the right side. Coming back, the weavers fall naturally into the space left for them across the top of the handle-bar and pass in under the border on the left side. Going over the third time, they pass into the left and end, and the winding is completed.

79. SET No 1.

On handle-bar to right first time over *red* line. First time back *green* line, second time over *yellow* line and ends.

SET No. 2.

On handle-bar to left first time over *blue* line. First time back *white* line, second time over *brown* line and ends.

DIAGRAM NO. 12.

80. COMMERCIAL BORDER NO. 2.

The principle of this border is the same as No. 1 Commercial Border with the following changes in the detail:

- (1) Lay down three spokes (70-1).
- (2) Carry each weaver in turn
 - (a) in front of two spokes—the first one is a laid-down spoke, the second one is the first standing spoke—
 - (b) across two sets of laid-down spokes
 - (c) back of the second standing spoke and to the outside of the basket, and
 - (d) lay the first standing spoke parallel with it.
- (3) In completing the border, there are three laid-down spokes to be carried in front of two spokes,

back of the third spoke, and to the outside of the basket.

(4) In carrying the short ends to the inside of the basket, allow them to pass in front of two spokes and in back of the third spoke.

The short ends pass in between the two spokes that fell back of the third spoke and the two that fell in front of it.

81. QUESTIONS.

Eighteen. On a basket woven on a base of thirteen spokes and twenty-six side spokes, if the right handle-bar of a split handle has been inserted alongside of the side spoke leading from the right side of the extra spoke in the base, and the left handle-bar has been inserted alongside the side spoke to the left of the middle thread on the same side of the button, state *precisely* alongside which threads and on which side of these threads the other ends of the handle-bars should be inserted.

Nineteen. When and why is a space allowed in the winds passing over the double part of the bar in winding a split handle?

CHAPTER VIII
 CANDY BASKETS WITH AND WITHOUT
 LIDS

82. MODEL 13.

DIMENSIONS

Base.....	3½ inches.
Height, from arrow at base, to top of weaving.....	3½ inches.
Opening.....	5½ inches.

MATERIALS

8 spokes, No. 4 reed, 30 inches long.
 Weavers, Nos. 2 and 3 reed.

It is not necessary to make a separate base in small baskets. Pierce the middle of four of the thirty-inch spokes and thread them with the remaining four.

With a No. 2 weaver make the usual button (35) of three winds and separate the spokes by "Japanese weave" (36), curving downward to obtain the necessary slope for the base. When the base measures three and one half inches in diameter, turn it over, holding the under-side of the weaving toward you and turn the spokes slightly upward by a four-rod arrow (19-20*d*). Weave one and one half inches of over-and-under weave (8*b*), carrying two weavers and giving the spokes a bowl-shaped curve.

The diameter at this point should be six and one

half inches. Weave two inches of triple weave (13), turning the spokes gradually in, so that at the given height from the arrow ($3\frac{1}{2}$ inches) the diameter of the opening will be five and one half inches.

BORDER

Back of one spoke and out.
Over two spokes and in.
Over two spokes and down and trim.

83. MODEL NO. 14.

DIMENSIONS

Base.....	$3\frac{1}{2}$ inches.
Height.....	4 inches.
Opening.....	6 inches.

MATERIALS

9 spokes, No. 4 reed, 30 inches.
Weavers, Nos. 2 and 3 reed.

Thread five needles with four threads and notice that the total number of spokes is eighteen. Japanese weave cannot be used except in the following way: After making the button of three winds, separate the spokes by one row of Japanese weave. On reaching the initial base spoke you will find that the weaver naturally passes over and under the same set of spokes in the second row as in the first; to avoid this, carry the weavers at the initial spoke under two spokes instead of one, and proceed with the Japanese weave. Each time when the weaver, if continued, would pass over the same set of spokes as in the preceding row, always change the weave by passing under two spokes. This forms a spiral coil on

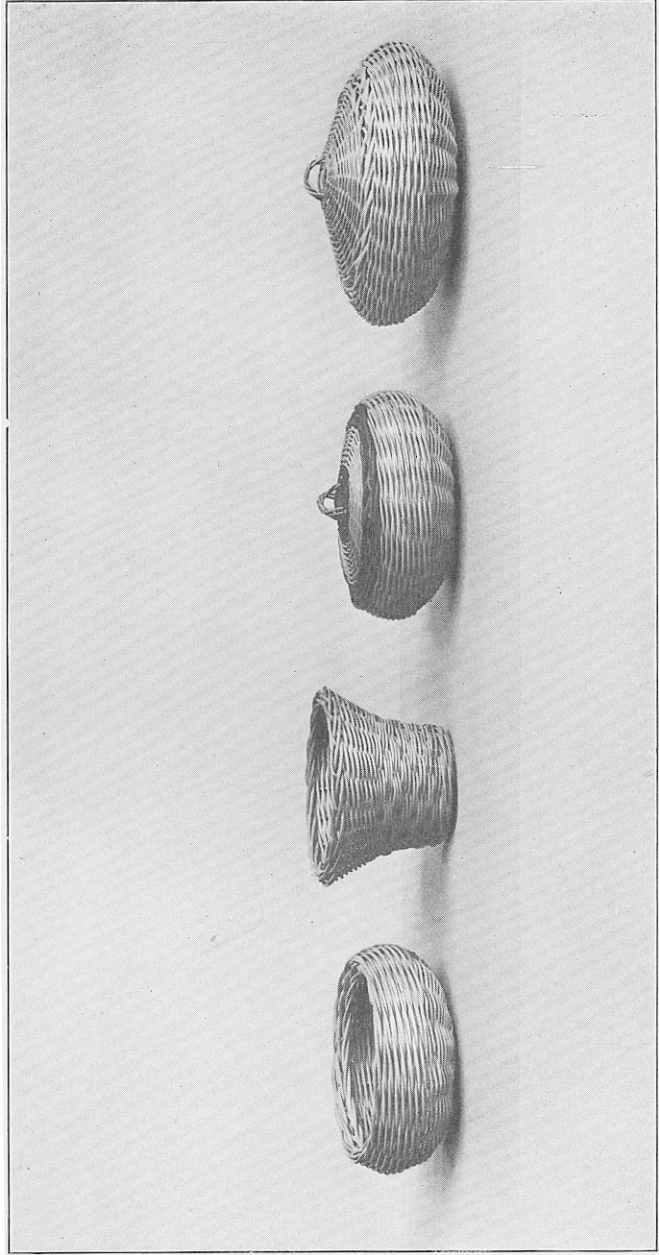

FIGURE X, MODELS 13, 14, 15, AND 15²

the under-side of the base, which is not a mistake in the weave, but is caused by passing under two spokes instead of one once on every circuit.

When the base is three and one half inches, crush the spokes and turn the basket at right angles to the base with three rows of a four-rod coil (15*b*-18).

Proceed with colonial weave (59) until the basket measures two and one half inches from the base, then with the triple weave until the height is four inches.

BORDER

Back of one spoke and out.

Over two spokes and in.

Over two spokes and down and trim.

84. MODEL No. 15.

Model No. 15 is given in two sizes, and the basket proper in each size is woven similar to the candy basket, Model No. 13 (82), with the following measurements:

MODEL No. 15, No. 1.

DIMENSIONS

Base.....	3½ inches.
Height.....	3½ inches.
Opening at top of weaving.....	6½ inches.
Opening after border is completed.....	5¾ inches.

MATERIALS

10 spokes, No. 4 reed, 32 inches.

Weavers, Nos. 2 and 3 reed.

5 threads through 5 needles.

85. BASKET PROPER.

Turn with a four-rod *arrow* (19-20*d*).

One and one half inches of over-and-under weave (8*b*).

Two inches of triple weave (13).

Diameter seven and one half inches at a point one and one half inches from base.

86. BASKET BORDER.

Wet the spokes but do not pinch them.

In front of two spokes and in.

Over three spokes and down and trim.

The opening inside the first row of the border measures five and three quarters inches and gives us the diameter for the finished lid, which will rest on the second row of the border. The lid must not fit too closely and should measure five and one half inches in diameter.

87. LID.

10 spokes, No. 4 reed, 30 inches.

5 threads through 5 needles.

Make a button (35) of three winds and separate the spokes by Japanese weave (36), curving slightly downward until the lid measures underneath four and three quarters inches in diameter. This allows three eighths of an inch for border on each side, or a total of three quarters of an inch for the border, giving the desired five and one half inches for the finished diameter.

88. LID BORDER.

Crush the spokes.

Each spoke in turn is carried under one spoke and up, and over one spoke and down, lacing the

last two spokes under and over the first two spokes of the border.

89. LIFT ON LID.

Select a pliable weaver of No. 3 reed and cut two weavers, each measuring twelve inches long.

(a) Bring the two ends of one of these weavers from the under-side of the lid up between the two outside needles, on one side of the button.

(b) Bring the two ends of the other weaver up on the opposite side of the button, on the outside of the needles.

DIAGRAM No. 13.

(c) Holding the ends of the second weaver (b), one in each hand, cross the right-hand end over the left, until you have three twists. Carry the end down to the under-side of the lid on the opposite sides of the button, on the outside of the needles.

DIAGRAM No. 14.

(d) Turn the lid around and carry the other set of ends (a) to the opposite side of the button in the following manner. These ends are carried over separately and each one must have four distinct curves.

I. THE WEAVER TO THE LEFT.

(a) Curve to the right, under one weaver.

(b) Curve to the left, above two weavers.

(c) Curve to the right, under two weavers.

(d) Curve to the left, above one weaver, and to the inside of the lid between the two outside needles on the left.

2. THE WEAVER TO THE RIGHT.

- (a) Curve to the left, above two weavers.
- (b) Curve to the right, under three weavers.
- (c) Curve to the left, above three weavers.
- (d) Curve to the right, under two weavers, and to the inside of the lid between the two outside needles on the right.

DIAGRAM No. 15.

(e) Fasten the four ends underneath by carrying each pair across under the button and draw them under the original loop of the opposite weaver, and trim.

90. MODEL No. 15, No. 2.

DIMENSIONS

Base.....	3½ inches.
Height.....	4½ inches.
Opening at top of weaving.....	7½ inches.
Opening after completion of border.....	6¾ inches.

MATERIALS

13 spokes, No. 4 reed, 34 inches.
 Weavers, Nos. 2 and 3 reed.
 6 threads through 7 needles.

BORDER

Same as basket border of No. 1, Model 15 (86).

LID

10 spokes, No. 4 reed, 30 inches.
 5 threads through 5 needles.

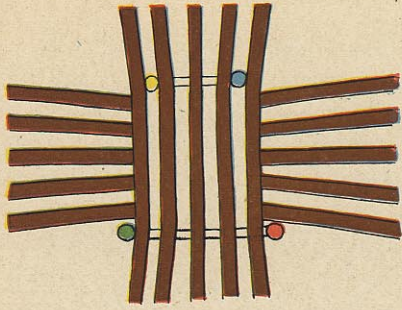

DIAGRAM NO. 13

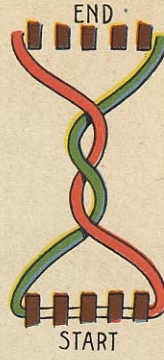

DIAGRAM NO. 14

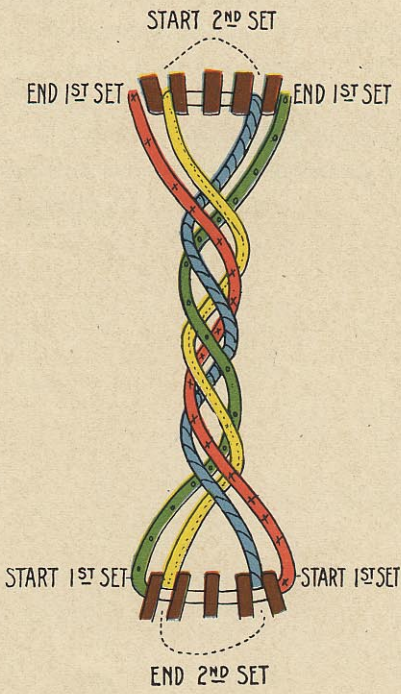

DIAGRAM NO. 15

DIMENSIONS

Diameter of lid, without border $5\frac{3}{4}$ inches.

Diameter of lid, with border $6\frac{1}{2}$ inches.

BORDER

Same as lid of border No. 2, Model 15 (88).

91. QUESTIONS.

Twenty. If the finished diameter of a basket measures six and five eighths inches, what should the diameter of the lid measure before putting in the border, used in the lids of Model 15?

Twenty-one. What weaves can be used on Model 13, the total number of side spokes being sixteen? What weaves cannot be used?

Twenty-two. What weaves can be used on Model 14, the total number of side spokes being eighteen? What weaves cannot be used?

CHAPTER IX
INDIAN CENTRES

Violet Bowl and Table Jardinière

92. NEW PROPOSITIONS.

- (a) Indian centres.
- (b) Overspoked basket with standard.
- (c) Pairing arrow.

93. INDIAN CENTRES.

Examples of four Indian centres are given and may be used in small, bowl-shaped baskets and lids, where an artistic centre is desired, but never in baskets that demand strong side spokes.

94. INDIAN CENTRE NO. 1. SIXTEEN SPOKES.
SEE DIAGRAM NO. 16.

Divide into four groups, each containing four spokes. Mark the middle of each spoke.

(a) The first group is held horizontally, directly in the middle, with the left hand.

(b) The second group is placed vertically, back of the first group, so that the two groups bisect each other.

(c) The third crosses diagonally back of the first and second groups, with its upper end at the right of the vertical group and its middle under the point where the first and second groups cross.

(*d*) The fourth group crosses diagonally back of the three groups, with its upper end at the left of the vertical group and its middle under the point where the others cross.

95. WEAVING.

Select a No. 2 weaver and with the right hand begin the weaving at the back of the lower left diagonal group.

Carry it over the left horizontal group.

Under the upper left diagonal.

Over the upper vertical group.

Under the right upper diagonal.

Over the right horizontal group.

Under the right lower diagonal group.

Over the lower vertical group.

Under the left lower diagonal group, and continue passing over and under the same groups until three strokes have been woven.

As the weaver passes on its third circuit under the left lower diagonal group, change the weave by carrying it under the left horizontal group also (*i. e.*, under two groups) and continue as before, this time passing over each group of spokes that the weaver passed under in the first three rows. Continue until three strokes in this circuit have been woven.

96. Separate the spokes into pairs by the over-and-under weave (8), bring the weaver under two spokes (not two groups) of the left horizontal group, over the next two spokes, and so on, changing the weave on each circuit by passing under four spokes. If preferred, two weavers (8*b*) may be used, as the

number of spokes is even. The total number of spokes is thirty-two, or sixteen pairs.

97. INDIAN CENTRE NO. 2. SIXTEEN AND ONE HALF SPOKES. SEE DIAGRAM NO. 17.

Sixteen spokes of required length.

Two spokes one inch longer than half the required length.

This centre is used in order to avoid using two weavers when one more set of spokes is desired, and when over-and-under weave (8) is to be used in weaving the sides of the basket.

98. Centre No. 2 is begun very much the same as centre No. 1, excepting that the two short spokes are placed between the two sets of spokes in the upper half of the vertical group, making six spokes in this group; allowing the short ends of these extra spokes to pass about an inch below the horizontal group. The weaving is the same as in centre No. 1, regarding the six spokes in the upper vertical as one group.

99. When the spokes are separated into pairs, the short ends are not considered as a pair, but in the first row one short end is woven over with one pair and the other short end with the next pair, and gradually these short ends fall out of the weaving entirely.

The total number of spokes is thirty-four, or seventeen pairs.

100. INDIAN CENTRE NO. 3. SIXTEEN SPOKES. SEE DIAGRAM NO. 18.

Divide into four groups containing four spokes.

The first group is held horizontally.

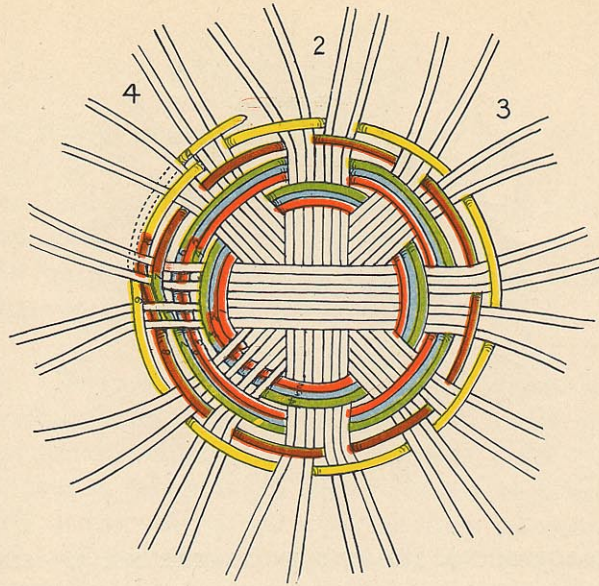

DIAGRAM NO. 16. INDIAN CENTRE NO. 1. SIXTEEN SPOKES

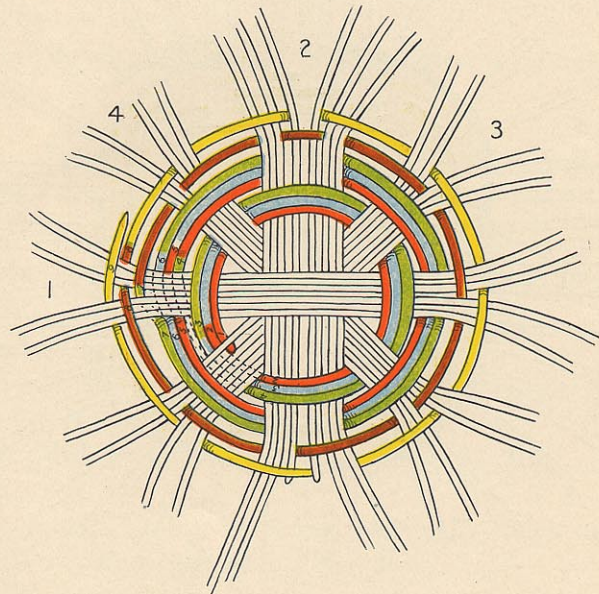

DIAGRAM NO. 17. INDIAN CENTRE NO. 2. SIXTEEN AND ONE HALF SPOKES

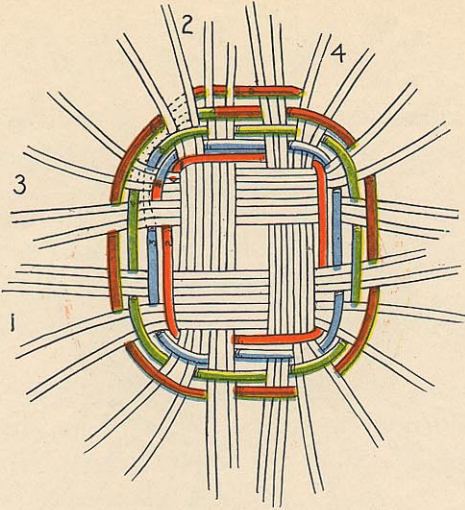

DIAGRAM NO. 18. INDIAN CENTRE NO. 3. SIXTEEN SPOKES

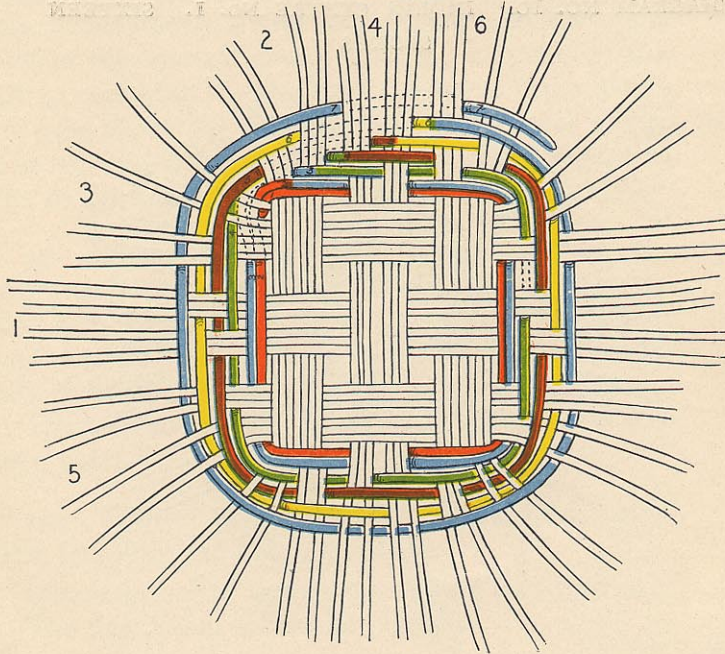

DIAGRAM NO. 19. INDIAN CENTRE NO. 4. TWENTY-FOUR SPOKES

The second group is placed vertically back of the first group.

The third group is placed horizontally back of the second group.

The fourth group is placed vertically back of the third group and over the first group.

101. Begin the weaving back of the upper left horizontal group alternating over and under the groups for one circuit (two if preferred). *Even up* the spokes at this point, if they have not been held directly at the centre, and separate them into pairs by over-and-under weaving (8), bringing the weaver up between the two pairs of spokes in the upper left horizontal group. Change the weave on each circuit by passing under two pairs or four spokes or by using two weavers.

Total number of spokes is thirty-two, or sixteen pairs.

102. INDIAN CENTRE No. 4. TWENTY-FOUR SPOKES. SEE DIAGRAM No. 19.

This centre is an elaboration of centre No. 3.

Divide into six groups, each containing four spokes.

The first group is held horizontally.

The second group is placed vertically back of group No. 1.

The third group is placed horizontally back of No. 2.

The fourth group is placed vertically back of group No. 3 and over group No. 1.

The fifth group is placed horizontally back of group No. 2 and over group No. 4.

The sixth group is placed vertically back of group No. 1 and over groups Nos. 3 and 5.

103. Begin the weaving back of the upper left horizontal group, alternating over and under the groups of spokes until two circuits are made.

Bring the weavers up between the pairs of spokes in the left horizontal group, and even up the spokes before separating them into pairs by passing over and under two pairs of spokes.

Change the weave in each row by passing under three pairs. Notice that this weave causes a rope effect.

Total number of spokes is forty-eight or twenty-four pairs.

104. OVERSPOKED BASKET WITH STANDARD.

Models 16 and 17 are examples of baskets with spokes carried from the border over the weaving to the base and there woven into a standard. It is more effective in these models to use a small-sized reed for the spokes (as Nos. 2 and 3) and to carry the spokes in pairs, rather than to use a larger single spoke.

105. PAIRING ARROW. TWO WEAVERS.

There are two methods of pairing.

(a) Each weaver to the left is carried in turn in front of one spoke and *on top* of the weaver to the right, then back of the second spoke and out.

(b) Each weaver to the left is carried in turn in

front of one spoke and *under* the weaver to the right, then back of the second spoke and out.

106. A pairing arrow requires two rows of pairing and is similar to a three-rod arrow except that two weavers are used instead of three, and consequently

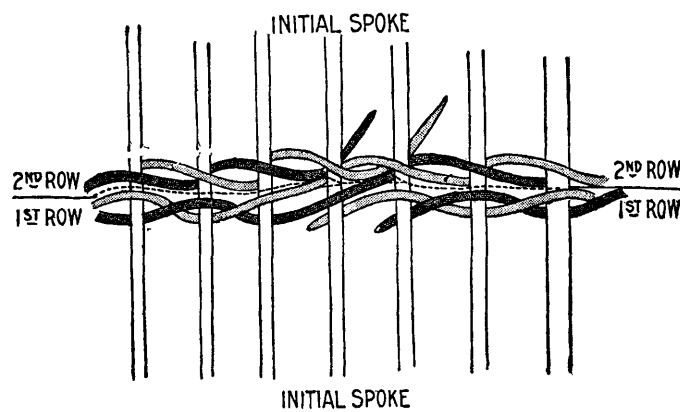

DIAGRAM NO. 20

the weavers in turn pass in front of one spoke instead of two.

(a) Row one of a pairing arrow.

Use the first method of pairing (105a) and reverse the weaving at the initial spoke.

(b) Row two of pairing arrow.

Use the second method of pairing (105b) and complete the arrow by allowing the first weaver to end back of the initial spoke, and the second weaver to lace under the first stroke in the second row, and end back of the spoke to the right of the initial spoke.

107. MODEL NO. 16. VIOLET BOWL. INDIAN
CENTRE NO. 2. SIXTEEN AND ONE HALF SPOKES
(97).

DIMENSIONS

Base.....3 inches.
Height from top of weaving... $3\frac{3}{4}$ inches.
Greatest diameter..... $6\frac{1}{2}$ inches.
Opening, without border..... $4\frac{1}{4}$ inches.
Opening, with border..... $2\frac{3}{4}$ inches.

MATERIALS

16 spokes, No. 2 reed, 32 inches.
2 spokes, No. 2 reed, 17 inches.
Weavers, No. 2 reed.
Glass finger-bowl.

Diameter of opening in bowl.... $4\frac{1}{4}$ inches.
Height of bowl..... $2\frac{1}{2}$ inches.

Indian centre No. 2 is used in this model and a base woven three inches in diameter.

Two spokes are used as one throughout this model.

Curve the spokes slightly upward, using a pairing arrow (106).

Weave in over-and-under weave (8a) with a gradual bowl-shaped curve of the spokes until the diameter of the basket at half its height is fully two inches greater than the diameter of the finger-bowl. In the dimensions given the diameter is two and one fourth inches greater.

From this point curve the spokes in toward the

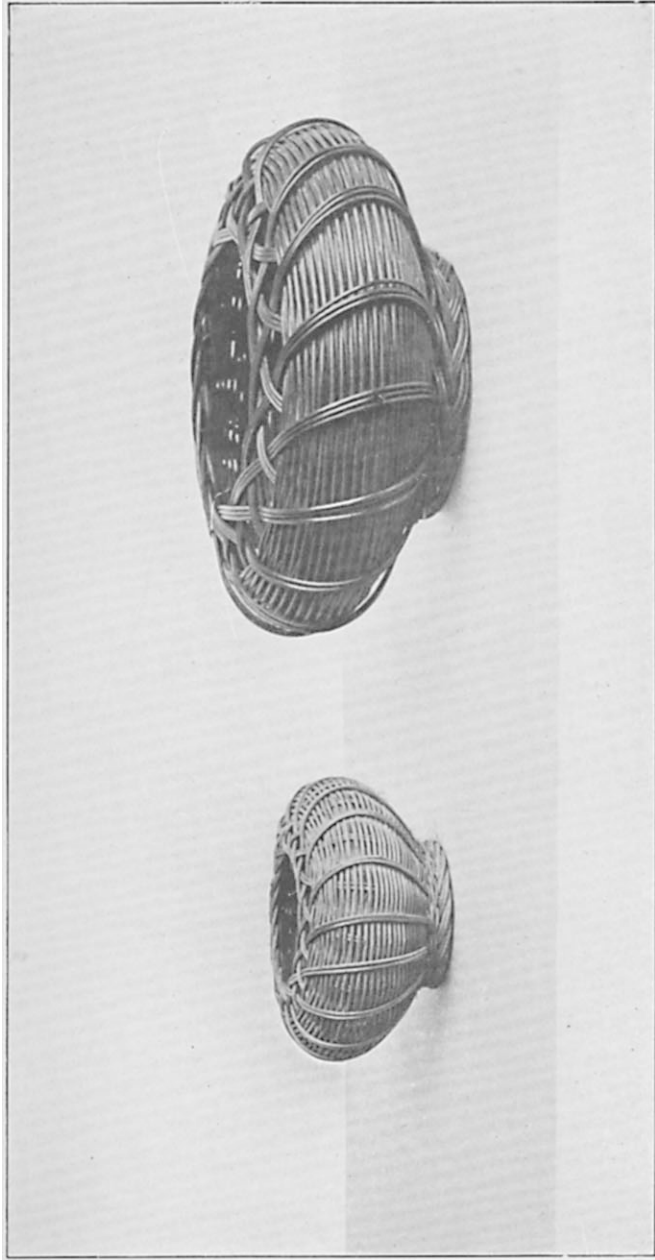

FIGURE XI, MODELS 16 AND 17

top of the bowl and continue until the weaving meets the rim of the finger-bowl.

108. BORDER.

Each pair of spokes is carried in turn over two pairs of spokes and under one pair of spokes to the outside of the basket.

Turn the basket upside down and draw each pair of spokes in turn through the pairing arrow at the base, allowing them to take a natural curve over the basket proper, from the border to the base.

A good rule is to carry each pair as it leaves the border over one pair of spokes in the basket proper and insert through the arrow to the left of these spokes.

109. STANDARD.

Holding the basket upside down making a pairing arrow (106). Carry each pair of spokes in turn in front of two pairs of spokes and back of one pair of spokes and trim, allowing a good end to prevent the border from pulling out.

110. MODEL No. 17. TABLE JARDINIÈRES.

DIMENSIONS

Base.....	5½ inches.
Height.....	5½ inches.
Opening, without border.....	9 inches.
Opening, with border.....	6 inches.
Greatest diameter.....	10 inches.

MATERIALS

8 base spokes, No. 5 reed, 7 inches long.
 48 side spokes, No. 3 reed, 25 inches long.
 Weavers, Nos. 2 and 3 reed.

BASE

Four threads through four needles.

Weave to five and one half inches in diameter, curving the base up instead of down, and forming it into the curve of a saucer having a very gradual slope. Insert side spokes at each spoke, two on one side of the spoke and one on the other.

Three spokes are used as one throughout this model.

Weave in triple weave (13) with a slight upward curve until the diameter is ten inches at half the total height of the basket. Then curve until the diameter is nine inches.

III. BORDER.

Carry each set of spokes in turn over two sets of spokes and under one set of spokes to the outside of the basket. Turn the basket upside down, and carry each set of spokes in its natural curve over the basket proper and draw them through two rows of weaving in the basket (about the third and fourth rows from the base) to hold them in place.

II2. STANDARD.

Crush the spokes close to where they leave the weaving and carry each set in turn.

(1) In front of two sets of spokes and back of one set and out.

(2) In front of two sets of spokes and in, and trim, not too close.

113. QUESTIONS.

Twenty-three. If you wish to use twenty-four spokes in an Indian centre No. 1, how can the spokes be grouped?

Twenty-four. Can a sixteen-and-one-half-spoke centre be grouped in an Indian centre No. 3?

If two weavers are used in separating the spokes in an Indian centre No. 1, behind which group is the second weaver inserted?

CHAPTER X

SCRAP BASKETS

114. CAUTION.

It is advisable for students to perfect themselves in the models and weaves already given in the preceding seven lessons before taking up scrap baskets or models requiring the heavier reeds.

115. There are three fundamental points in basket weaving relating to the position and direction of the spokes. These occur in every basket, and to be a proficient weaver a student must understand and conquer them.

116. FIRST.

The base spokes must radiate from the centre in straight lines and must be equal distances apart. One curved base spoke or any two spokes separated unevenly will cause a defect in the basket proper.

117. SECOND. The side spokes must be:

(a) An equal distance from the centre of the basket. In a model with curved sides the distance from the side spoke to the centre will, of course, vary with the curve, but at any given point each side spoke must be the same distance from the centre.

(b) An equal distance from each other.

The distance between the spokes will also vary with the curve, but at any given point this distance must be the same.

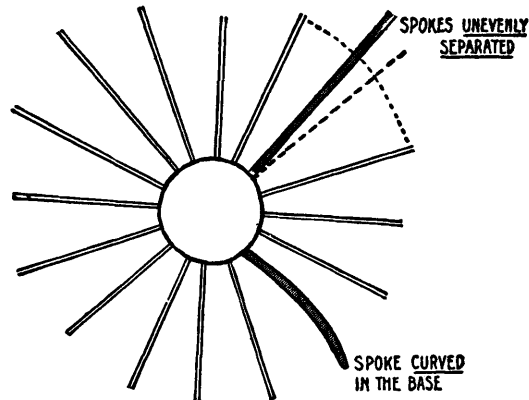

DIAGRAM NO. 21. CORRECT AND INCORRECT
BASE SPOKES

DIAGRAM No. 22. CORRECT SIDE SPOKES.

At *X* the spokes are an equal distance from the centre and an equal distance apart.

At *Y* the spokes are an equal distance from the centre, and an equal distance apart, but the distances at *Y* are greater than at *X*.

118. THIRD.

The side spokes throughout the basket radiating from the base spoke must be an equal distance from an imaginary line from the base spoke to the border. The side spokes in a basket have a tendency to swerve to the left of the point where they start from the turn at the base.

DIAGRAM NO. 23. CORRECT AND INCORRECT
SIDE SPOKES.

119. (*b*) is an imaginary *line* from the base spoke to the border.

1-1. *Correct direction* of the side spokes, each an
2-2. equal distance from the imaginary line (*b*)
3-3. and an equal distance from each other.

4-4•

5-5.

6-6.

7-7.

8-8.

etc.

1-m. *Incorrect direction* of the spokes swerving
2-n. to the left. The distance between the
3-o. spokes is equal, but the distance of the
4-p. spokes from the imaginary line (*b*) is not
5-q. equal.

6-r.

7-s.

8-t.

etc.

120. MODEL NO. 18. SCRAP BASKET.

DIMENSIONS

Base.....	6	inches.
Base, with arrow and coil.....	7½	inches.
Height.....	11	inches.
Opening.....	10	inches.
Greatest diameter.....	13	inches.
Turn the shoulder at height of.	9	inches.

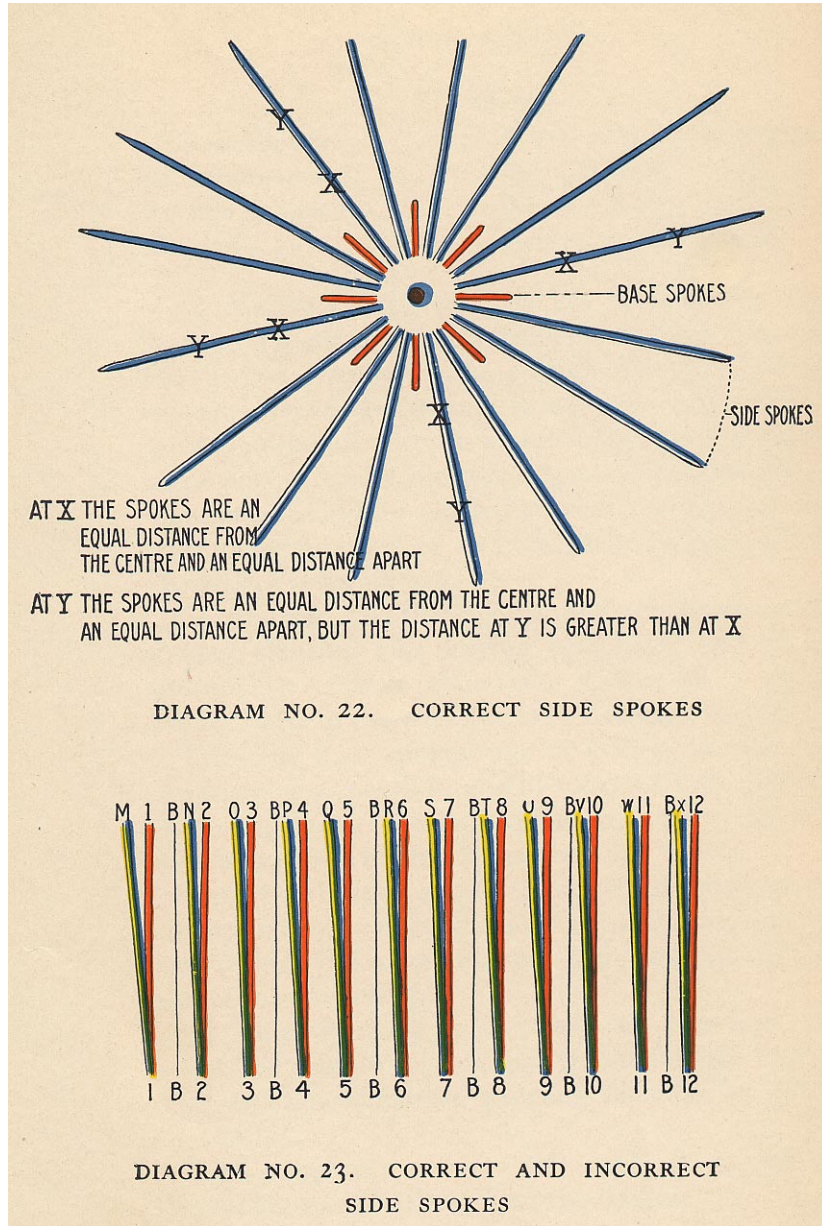

MATERIALS

8 base spokes No. 6 reed, 7½ inches.
 32 supporters No. 5½ reed, 12 inches.
 32 side spokes No. 6 reed, 22 inches.
 Weavers Nos. 3, 4, and 5 reed.

(a) Weave the button and the first half of the base in Japanese weave (10) with a pliable weaver No. 3, and change to No. 4 when the base is half woven. Draw the weaver down and under with a strong stroke, in order to give the base the necessary slope and to make the weaving as firm as possible. The base should be cupped so that the centre is at least three quarters of an inch from the table when the weave is completed.

(b) Sharpen the side spokes and supporters with a long slanting cut, having previously wet them thoroughly. Never allow side spokes for a scrap basket to *lie* in the water, as they become too pliable.

Trim the base spokes, one at a time, as close to the weaving as possible, and bi-spoke with the thirty-two supporters, pressing them well down in the weaving, to the button if possible.

Turn the base over and separate the supporters on the right side of the base an equal distance apart with a three-rod arrow (19-20) and crush the spokes close to the weaving.

(c) Turn the base upside down on your lap and insert the thirty-two side spokes, putting one to the right of each supporter, pressing them as far down as possible.

Each supporter with its side spoke is carried as one spoke, to add strength to the basket.

(*d*) Crush the side spokes close to the arrow and, using No. 5 reed, turn them with the supporters directly at right angles to the base with three rows of a four-rod coil (15*b*-17), and making an arrow with the fourth row (19-20*d*.)

(*e*) Place the basket on a table and put a heavy stone or brick inside to weigh it down.

Go around the basket holding the winding awl on the weaving and striking it with a hammer to drive the weaving down close at the turn.

It is well to repeat this hammering of the weaving at intervals of three inches, as it forces the rows of weaving together and makes a much firmer basket.

(*f*) Before beginning to weave the sides of the basket, direct each spoke into its proper position.

From this point on strict attention must be paid to the spokes. They will tend persistently to the left; each time the weaver is passed over or under a spoke it is necessary to see that it has its proper place.

Judge both from the inside and the outside of the basket.

(*g*) As the basket must have a diameter of thirteen inches, before beginning to weave measure the diameter between the spokes, nine inches from the table, and notice whether you must bring the spokes out or hold them in to secure the desired thirteen inches.

(*h*) A basket woven on a table has a tendency to come out too quickly, so make the slope very gradual and measure, from time to time, in order to calculate correctly.

Should the basket slope out too much, hold the

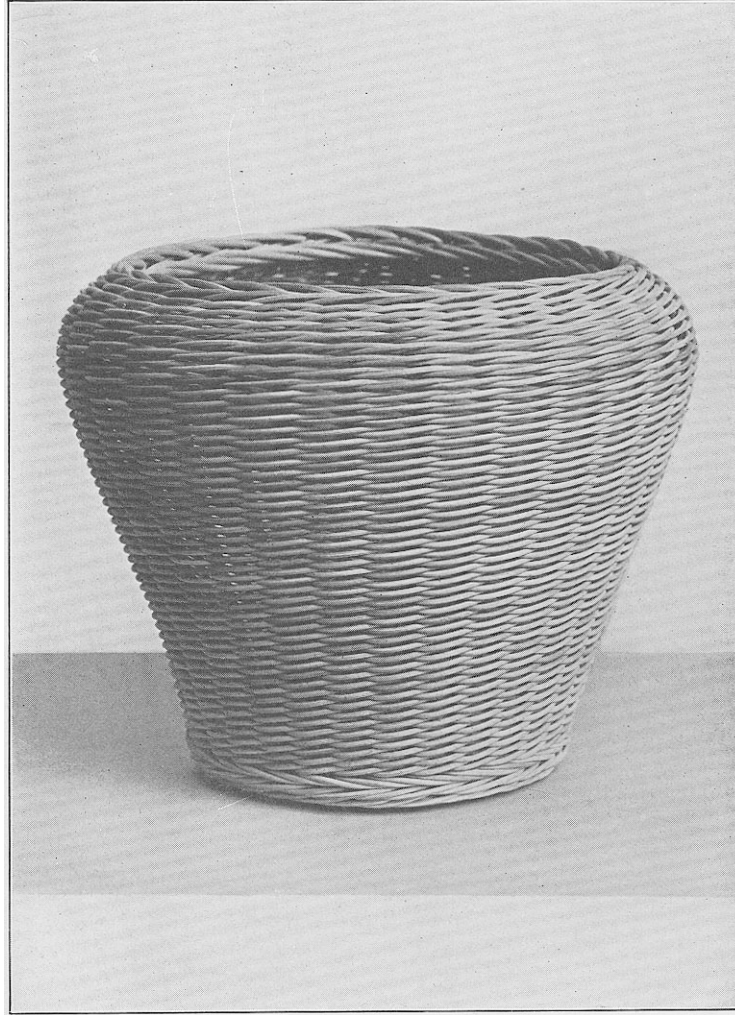

FIGURE XII, MODEL 18. SCRAP-BASKET

spokes straight; in case the diameter should be thirteen inches before the required nine inches in height is reached, weave the necessary distance on the straight before curving in on the shoulder.

(i) The shaping of a basket can only be acquired through practice, but endeavor from the first not only to form the basket in your mind but to produce that form and shape in imagination with the spokes.

Thus it is possible to calculate how the spokes must be directed to obtain it.

Use the foot rule constantly and always aim to work within given measurements.

(j) The basket proper in Model No. 18 from the coils and arrow at the turn is woven entirely in triple weave, using No. 4 reed.

It is much easier for a student to procure the desired shape with this weave than by the use of the bands.

(k) When the basket is nine inches high and thirteen inches in diameter, dampen the spokes and turn them toward the centre of the basket.

At this point the supporters have disappeared, and the long side spokes only are left.

Make a gradual curve in, at the shoulder of the basket, endeavoring to have the diameter of the opening eleven and one half inches when the height of the basket is eleven inches.

(l) Make a four-rod coil (15*b*, 18) of No. 5 reed.

Dampen and crush the spokes close to the coil and finish with the following border:

(*m*) SCRAP-BASKET BORDER.

First Row. Bring each spoke in turn in front of three spokes and in.

Second Row. Bring each spoke in turn over two spokes and down and trim.

It is customary to make the coil at the top of the basket with reed of the same number as the spokes, but a coil of No. 6 is too heavy with an opening of eleven and one half inches, so No. 5 or No. $5\frac{1}{2}$ is substituted.

(n) Singe the basket while damp, and notice if the opening is a perfect circle.

If the weaving of the basket, coil, and border has been done unevenly, then the opening will not be perfect.

Place the basket straight on the table or floor and let it dry.

121. QUESTIONS.

Twenty-five. Name the weaves that can be used on a basket with thirty-two spokes.

- (a) Using one weaver.
- (b) Using two weavers.
- (c) Using three weavers.

Twenty-six. Name the weaves that can be used on a basket with thirty-three spokes.

- (a) Using one weaver.
- (b) Using two weavers.
- (c) Using three weavers.

Twenty-seven. Name the weaves that can be used on a basket with thirty-four spokes.

- (a) Using one weaver.
- (b) Using two weavers.
- (c) Using three weavers.

CHAPTER XI
SCRAP BASKETS

MODELS Nos. 19 AND 20.

122. Model No. 19 demonstrates the variety produced in baskets by the use of bands.

The measurements are the same as Model No. 18 (120), and six different bands are given as an elaboration of the model.

DIMENSIONS

Base..... 6 inches.
Base, with arrow and coil..... $7\frac{1}{2}$ inches.
Height..... 11 inches.
Opening..... 10 inches.
Greatest diameter..... 13 inches.
Turn shoulder when the basket is nine inches high.

MATERIALS

8 base spokes, No. 6 reed, $7\frac{1}{2}$ inches.
32 supporters, No $5\frac{1}{2}$ reed, 10 inches.
32 side spokes, No. 6 reed, 22 inches.
Weavers, Nos. 3, 4, and 5 reed.

This model is turned at the base like Model No. 18 (120*b-d*), three rows of a four-rod coil of No. 5 reed, the fourth row forming an arrow.

123. SCRAP BASKET WITH BANDS OF ARROWS.

No. 1

Two and one half inches of triple weave (13) No. 4 reed.

Double three-rod arrow (19-21).

Two and one half inches of triple weave (13).

Double three-rod arrow (19-21).

Finish the basket in triple weave (13).

No. 2

Scrap basket with band of double Japanese weave (11).

Five inches triple weave (13) No. 4 reed.

Three inches of double Japanese weave (11).

Finish the basket in triple weave (13) No. 4 reed.

The band of double Japanese weave (11) may be inserted lower down in the basket but must never be used on the shoulder, and the band may be elaborated by using a four-rod coil (15*b*-18) or arrow (19-20*d*) on either side of it.

No. 3

Scrap basket with a band of three arrows (19).

Five inches of triple weave (13) No. 4 reed.

Three rows of a three or four rod arrow (19-20).

Explanation: It requires six rows to make three arrows.

First row coil; reversed but not locked.

Second row forms arrow.

Third row coil; reversed but not locked.

Fourth row forms arrow.

Fifth row coil; reversed but not locked.

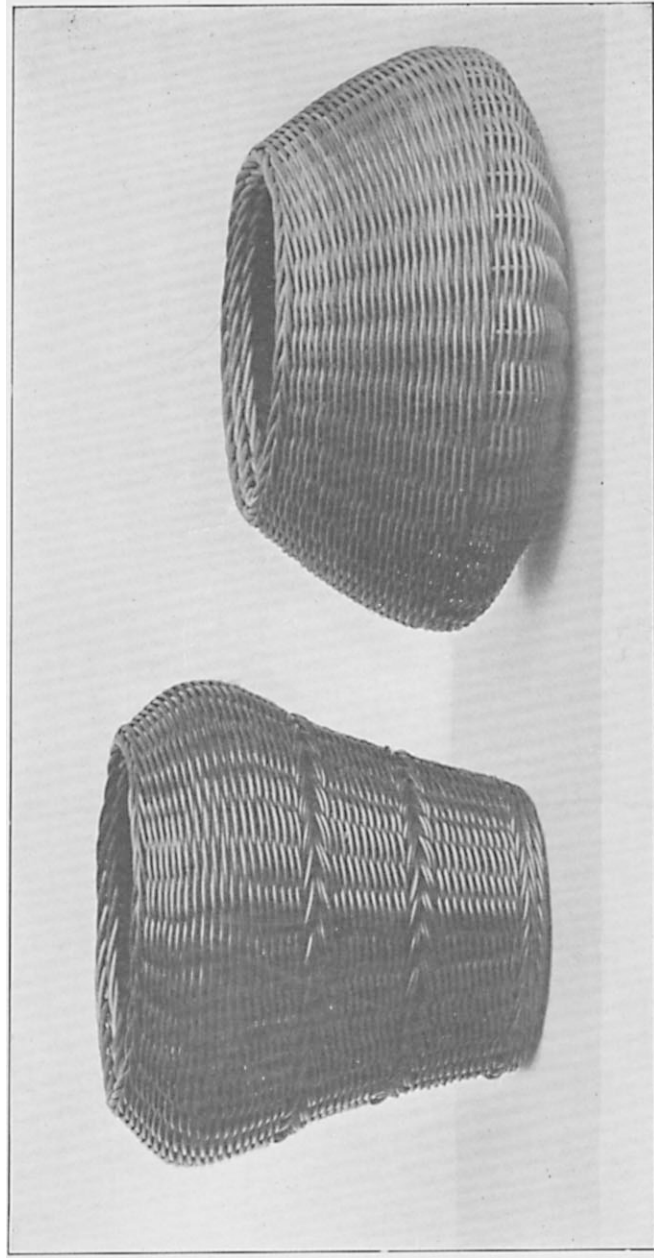

FIGURE XIII, MODELS 19 AND 20

Sixth row forms arrow.

Finish basket in triple weave (13) No. 4 reed.

No. 4

Scrap basket with rows of double Japanese weave (11).

Two inches of triple weave (13).

Two rows of Japanese weave (11), that is, twice around.

Two inches of triple weave (13).

Four rows of double Japanese weave (11) that is, four times around.

Two inches of triple weave (13).

Six rows of double Japanese weave (11), that is, six times around.

No. 5

Scrap basket with a band of coils and arrows (15-18) (19-20).

Five inches of triple weave (13) No. 4 reed.

Four-rod coil (15b-18) of No. 5 reed.

Arrow (19) of No. 2 reed.

Four-rod coil (15b-18) of No. 5 reed.

Finish the basket in triple weave (13) No. 4 reed.

No. 6.

Scrap basket with band of over-and-under weave (18).

This band may be used with or without four-rod coils on either side.

Single over and under (8b) No. 4 reed.

Double over and under (9b) Nos. 3 or 4 reed.

Triple over and under (carry three weavers as one) No. 3 reed.

124. MODEL NO. 20. LOW SCRAP BASKET.

This basket is suitable for palms, as well as for a library, bedroom, or porch scrap basket.

The measurements used in this model were taken from pottery.

DIMENSIONS

Base.....	8½ inches.
Height.....	8½ inches.
Opening, with border.....	9 inches.
Greatest diameter.....	16 inches.

From coil at base to border (with the tape measure) eleven inches.

Five inches of over and under (8*a*) and six inches of triple weave (13).

MATERIALS

8 base spokes, No. 7 reed, 10 inches.
 35 side spokes, No. 6 reed, 25 inches.
 Weavers, Nos. 3, 4, and 5 reed.

No supporters are used in this model, and the spokes are not crushed at the turn at the base.

Weave the base as described in Model No. 18 (120). Bi-spoke the base spokes with the side spokes, and insert three extra spokes at equal distances apart, giving three side spokes at three of the base spokes.

Separate the spokes on the right side of the base with a three-rod arrow (120*b*); with the under-side of the base toward you turn the basket with a four-rod coil (15*b*-18) of No. 5 reed, directing each spoke slightly upward.

Weave three and one half inches in single over-and-under weave (8*a*), endeavoring to have the diameter at this point sixteen inches; the slope from the coil is a very gradual one, and great care must be exerted to carry out the three fundamental rules given in lesson No. 8 (115-118).

When the required diameter has been reached, turn the spokes *directly in* until the five inches is completed of the over-and-under weave.

Place the basket on the table and weight it, and continue the weaving of six inches in triple weave (13), directing the spokes to obtain the nine-inch opening, at the height eight and one half inches.

When diameter is eleven and one half inches, finish the basket with a three-rod coil (15*a*) of No. 5 reed and the following border:

Crush spokes and bring each in turn,
First row in front of two spokes and in,
Second row over two spokes and down,
Third row over two spokes and down and trim.

125. QUESTIONS.

Twenty-eight. Using border given for Model No. 20, would it be correct to use a four-rod coil to finish the basket and why?

Twenty-nine. Give two reasons for using thirty-five side spokes in Model No. 20 instead of thirty-two.

CHAPTER XII

OVAL BASE

126.

MATERIALS

6 needles, No. 5 reed, 5 inches.

3 threads, No. 5 reed, 7 inches.

2 supporters, No. 5 reed, 7 inches.

Thread the six needles with the three threads.

Place the two middle needles over the centre of the three threads and draw the two other pairs three fourths of an inch away from the middle ones.

(a) Holding the spokes in the left hand, with the

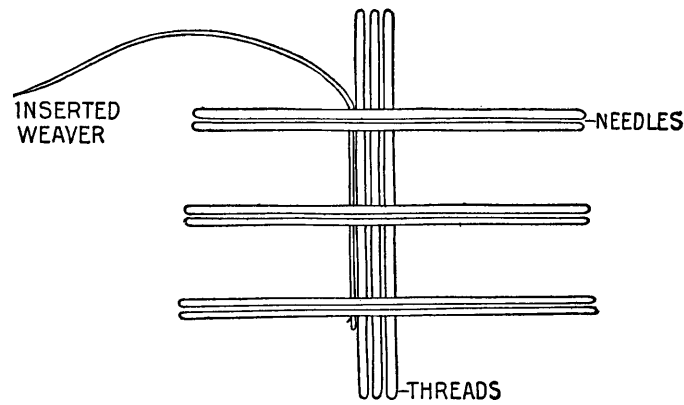

DIAGRAM NO. 24

threads vertical, select a pliable No. 2 weaver, run it down through the three pairs of needles, along the threads on the left-hand side.

(b) Hold the spokes so that the needles are vertical and the threads parallel with your body.

Carry the long end of the weaver from the lower left angle across the first pair of needles (to the left), to the upper right angle (Diagram 25 [1-2]), and down under the threads to the lower right angle (Diagram 25 [2-3]), and up and across the upper left angle (Diagram 25 [3-4]), and down and under diagonally across to the lower right angle (Diagram 25 [4-5]).

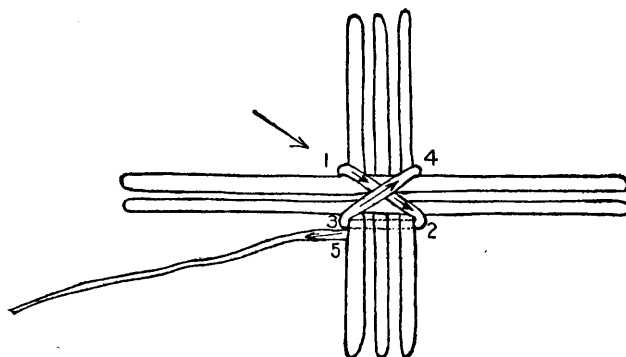

DIAGRAM NO. 25. WINDING OF INTERSECTION OF NEEDLES AND THREADS IN AN OVAL BASE

Repeat the cross as described in (b) over the second pair of needles.

Wind the threads with eight winds and repeat the cross as described in (b) over the third pair of needles and bring the weaver up and out finally at the lower right angle of the lower pair of needles.

This is called the "spine of the base."

Sharpen the ends of the two supporters and drive them on each side of the spine up through the open-

ing in the needles, which adds great strength to an oval base.

DIAGRAMS NOS. 26 AND 27.

127. Crush the supporters at the four points where they intersect the needles.

The initial spoke is the lower left thread and the weaver is brought up between it and the supporter.

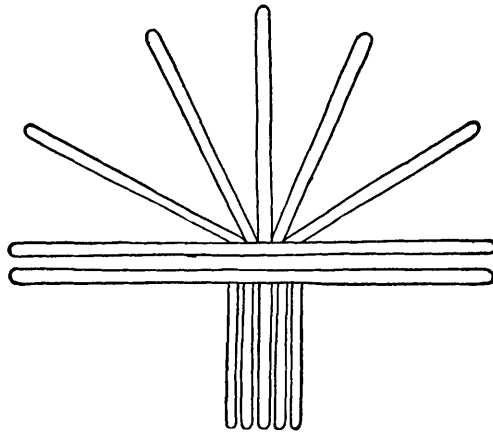
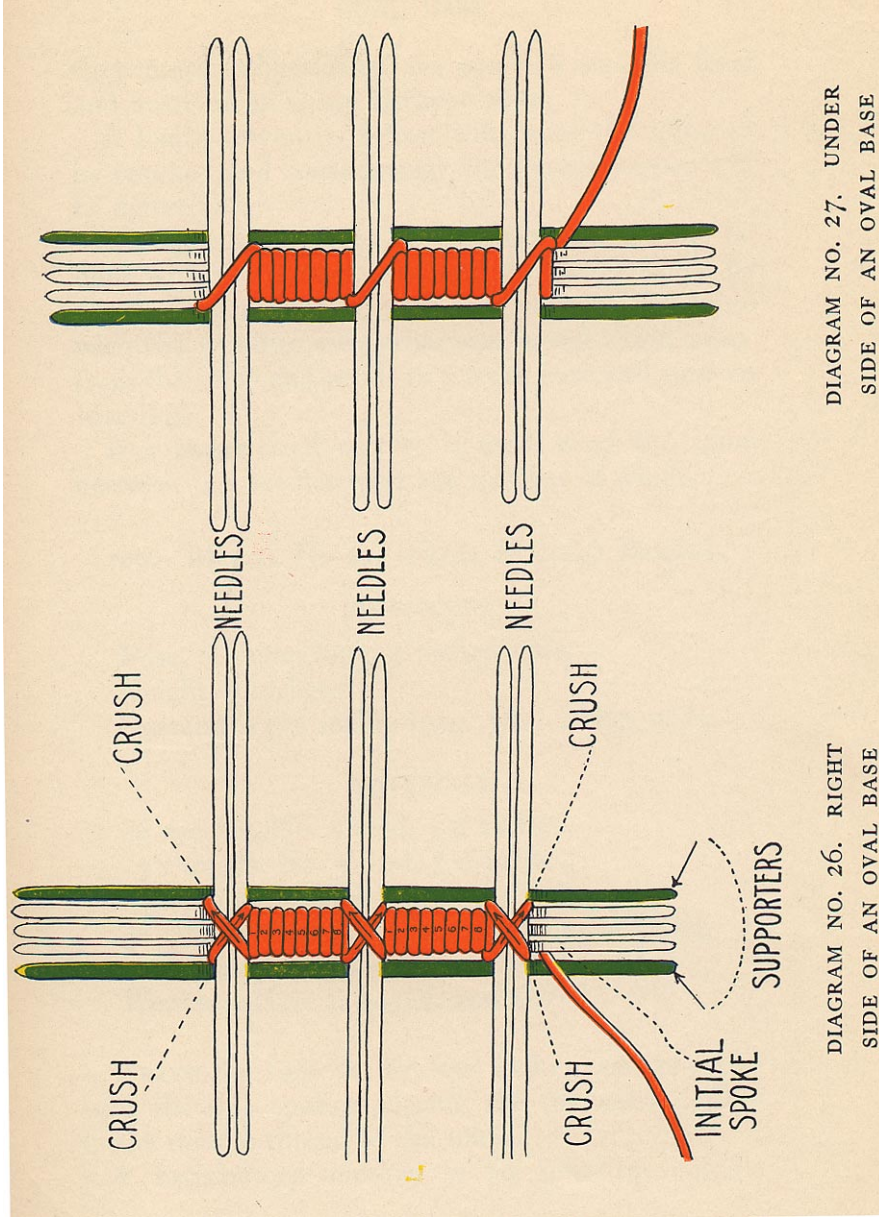

DIAGRAM NO. 28. SEPARATING SPOKES
IN AN OVAL BASE

Separate the spokes with Japanese weave, treating each pair of needles as one spoke, but separating the threads and supporters at either end, at equal distances, considering the middle thread as the spine, and keeping it at right angles to the needles, but directing the threads and supporters on either side toward the needles to form a fan shape.

128. The base must be sloped similar to a round one and the same rule applies in regard to the spokes;



they must radiate from the spine in straight lines and must be an equal distance apart.

A badly woven oval base will cause the spine to be crooked and consequently the basket proper will be defective.

The first few weaves of Japanese weave must be done with the utmost care, and the weaver must be drawn very tight and pressed in close to the spine with the winding awl, otherwise it will stand away from the spine and result in a weak base and uneven weaving.

If a larger-sized weaver is used, wind the spine between the needles with less number of winds.

129. MODEL NO 21. OVAL MARKET BASKET.

DIMENSIONS

Base, 6 inches long, 4 inches wide.

Height, 7 inches.

Opening, $14\frac{1}{2}$ inches long, $12\frac{1}{2}$ inches wide.

MATERIALS

6 needles, No. 5 reed, $5\frac{1}{2}$ inches.

3 threads, No. 5 reed, $7\frac{1}{2}$ inches.

2 supporters, No. 5 reed, $7\frac{1}{2}$ inches.

34 side spokes, No. $4\frac{1}{2}$ reed, 20 inches long.

2 handle-bars, No. 10 reed, 26 inches.

Weavers, Nos. 2, 3, $3\frac{1}{2}$, and 4 reed.

Weave the base six by four inches, and bi-spoke with the side spokes, placing the two extra spokes in the middle thread of the spine.

A satisfactory method is to split the middle

thread in the base spokes with the winding awl and run the extra spoke well down in the middle of the spoke, which helps to hold the side spoke firmly in its proper place.

In weaving the sides of an oval basket mark this extra spoke at each end, and remember that this spoke is the centre of the oval ends and must be held in this central position in respect to the spokes on either side of it.

Crush the spokes and turn the basket with three rows of a four-rod coil, making an arrow with the fourth row.

Weave two and one half inches of single Japanese weave (10) No. 3 reed, a four-rod arrow (19-20*d*) of No. 4 reed, three inches of two-ply weave (62) No. 3½ reed.

Crush the spokes and finish with a commercial border No. 2 (Lesson 5).

Insert the handle-bars on the long side of the oval, and allow the two middle spokes to intervene between the spokes where the bars are inserted.

Wind the split handle as in Lesson 5.

130. MODEL NO. 22. OVAL BASKET WITH HANDLE.

DIMENSIONS

Oval base, 6 inches by 4.

Height, 6 inches.

Opening, 9½ inches by 11½ inches.

MATERIALS

6 needles, No. 5 reed, 5½ inches.

3 threads, No. 5 reed, 7½ inches.

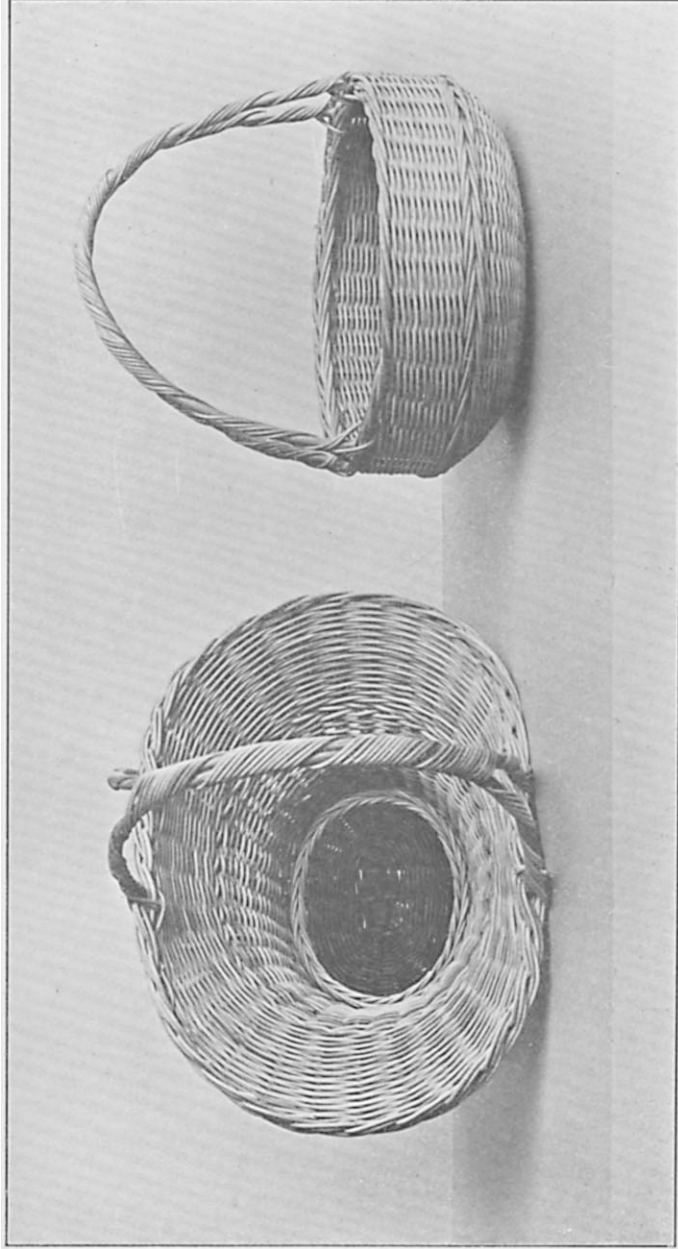

FIGURE XIV, MODELS 21 AND 22

2 supporters, No. 5 reed, 7½ inches.
 34 side spokes, No. 4½ reed, 20 inches.

131. Weave base six inches by four inches and bi-spoke with the side spokes as in Model No. 21.

Separate with a three-rod arrow (19) and turn the spokes slightly upward, with a locked four-rod coil of No. 4 reed (15*b*-18).

Weave three inches in single Japanese weave (10) with No. 3 reed.

Four-rod arrow (19-20*d*) of No. 4 reed.

Two inches of two-ply (62) of No. 3½ reed.

132. Finish with the following border:

Crush the spokes and carry each spoke in turn.

First row, back of one spoke and out.

Second row, over three spokes and in.

Third row, over two spokes and down and trim.

Insert the handle-bars lengthwise in the basket, leaving one spoke between the two spokes where the bars are inserted, and wind as in Lesson 5.

133. QUESTIONS.

Thirty. State four distinct different points in the weaving of round and oval bases.

Thirty-one. Give the reason for placing an extra spoke in the middle thread of an oval base.

Thirty-two. If thirty-two spokes are used in the sides of a basket in an oval base (three threads and three double needles) and three are placed in the middle thread at each end, how are the remaining twenty-six spokes inserted in the base?

CHAPTER XIII

CULLING-FLOWER BASKETS

134. MODEL No. 23.

DIMENSIONS

Base, 5 by 7 inches.

Height, 5 inches, with the tape measure, from the arrow in the base to the top of the weaving.

Opening, 15 inches by 17 inches.

MATERIALS

6 needles (3 pairs), No. 7 reed, $6\frac{1}{2}$ inches long.

3 threads, No. 7 reed, $8\frac{1}{2}$ inches long.

2 supportors, No. 7 reed, $8\frac{1}{2}$ inches long.

32 side spokes, No. $5\frac{1}{2}$ reed, 18 inches long.

2 handle-bars, No. 10 reed, 28 inches long.

Weavers, Nos. 3 and 4 reed.

Thread the three pairs of needles with the three threads, and wind five times between the needles with a pliable No. 3 weaver.

Insert the supportors and weave the base until it measures, underneath, five inches wide by seven inches long.

As these flower baskets are flat, do not cup the

base too much but make the weaving very close and firm and give the spokes a very gradual slope.

Insert the thirty-two side spokes as follows: one at each middle needle, bi-spoking the other base spokes and placing the extra side spoke in the middle thread of the base spokes.

Separate the spokes with a four-rod arrow with No. 4 reed (19-20d), turn the basket upside down, and weave two and one half inches of *double* Japanese weave (11), wrong side out.

Explanation: As the basket is flat we wish the right side of the weaving to be inside, therefore reverse Japanese weave by going under two spokes and over one spoke.

135. MENDING DOUBLE JAPANESE WEAVE.

(WRONG SIDE OUT.)

Allow the short end to rest in front of a spoke on the side of the basket toward you, insert the new weaver (irrespective of which weaver is being mended) below the two weavers, and allow it to rest back of the spoke to the left of the mending spoke, that is, inside the basket.

The short weaver ends on the outside of the basket and the new weaver begins on the inside and both are trimmed with a very slanting cut.

Slope the side spokes very gradually, giving those on the outside of the oval, where the handle is to be inserted, a more direct upward slope than those on the ends.

Weave two and one half inches of two-ply weave (62) and finish with commercial border No. 2 (80).

Insert the handle-bars crosswise, leaving one spoke between, and wind as in Lesson 5 (75).

136. MODEL NO. 24. LARGE GATHERING BASKET.

DIMENSIONS

Base, 7 by 9 inches.

Height, 6 inches from the arrow in the base to the top of the weaving.

Opening, 19 by 21 inches.

MATERIALS

6 needles (3 pairs), No. 7 reed, 8½ inches long.

5 threads, No. 7 reed, 11½ inches long.

2 supporters, No. 7 reed, 11½ inches long.

40 side spokes, No. 5½ reed, 20 inches long.

2 handle-bars, No. 7 reed, 34 inches long.

Weavers, No. 4 reed.

Thread the three pairs of needles with the five threads and wind six times between the pairs of needles with a pliable No. 4 reed.

Insert the supporters, remembering to crush them, and separate the spokes with a gradual slope until the base measures seven inches by nine inches.

Insert the side spokes, one at each middle needle, bi-spoking the other base spokes, and inserting the extra spoke in the middle thread.

Separate the side spokes with a four-rod coil (15-18) of No. 4 reed, turn the basket over and weave from the under-side, in No. 4 reed, three inches of single Japanese weave (10), wrong side out—that is, under two spokes and over one spoke, curving the spokes as in Model No. 23.

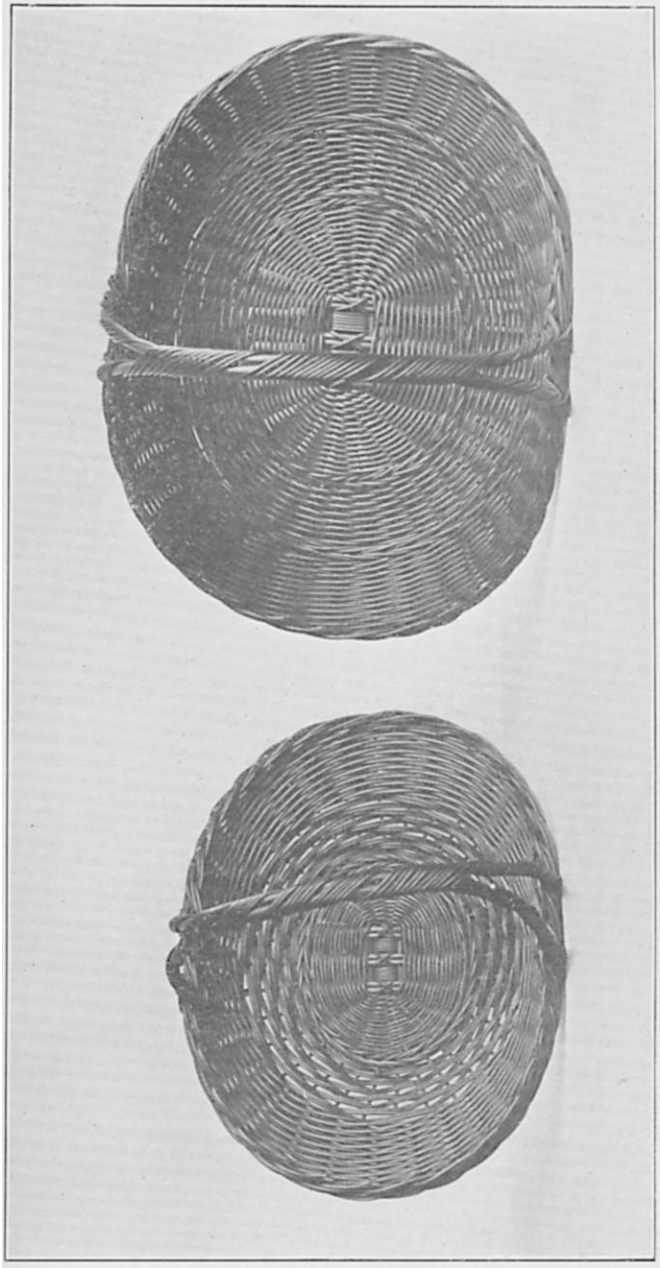

FIGURE XV, MODELS 23 AND 24

137. MENDING SINGLE JAPANESE WEAVE.
(WRONG SIDE OUT.)

Allow the short weaver to end in front of a spoke on the side of the basket toward you.

Insert the new weaver on the right side of the spoke to the left of the mending spoke and carry it in front of the mending spoke, back of the two spokes, and out, and proceed with the weaving.

Place the basket on your lap and weave a four-rod arrow (19-20*d*), in No. 4 reed, on the inside of the basket.

Reverse the basket again, weaving on the outside, and weave three inches of two-ply (62) weave and finish with commercial border No. 2 (80).

Insert the handle-bars crosswise, leaving one side spoke between, and wind as in Lesson 5 (75).

138. QUESTIONS.

Thirty-three. How many spokes come into play with each stroke of the weavers in—

- (a) Pairing?
- (b) Triple weave?
- (c) Four-rod coil?

State the general rule.

Thirty-four. What weaves can be used in Model No. 24?

Thirty-five. What constitutes the spine of an oval base?

Thirty-six. Is the initial spoke of the spine the same as the initial spoke of the base in an oval base?

Thirty-seven. State the difference between pairing and under-and-over weave on an even number of spokes where two weavers are used.

CHAPTER XIV

- (a) TABLE OF WEAVES.
- (b) TABLE OF COILS.
- (c) TABLE OF SCALE OF MEASUREMENTS FOR SERIES OF BASKETS.
- (d) TABLE OF BORDERS.

(a) WEAVES

139. NUMBER ONE

UNDER-AND-OVER WEAVE, ODD NUMBER OF SPOKES.

Under-and-over weave, one weaver, in front of one and back of one.

Double under-and-over weave, two weavers carried as one, in front of one and back of one.

Triple under-and-over weave, three weavers carried as one, in front of one and back of one.

NUMBER TWO

UNDER-AND-OVER WEAVE, EVEN NUMBER OF SPOKES.

Under-and-over weave, two weavers, in front of one and back of one.

Double under-and-over weave, four weavers, two carried as one, in front of one and back of one.

Triple under-and-over weave, six weavers, three carried as one, in front of one and back of one.

NUMBER THREE

JAPANESE WEAVE, NUMBER OF SPOKES NOT DIVISIBLE BY THREE.

Japanese weave, one weaver, in front of two and back of one.

Double Japanese weave, two weavers carried as one, in front of two and back of one.

Triple Japanese weave, three weavers carried as one, in front of two and back of one.

NUMBER FOUR

PAIRING WEAVE, ON ANY NUMBER OF SPOKES.

Pairing weave, two weavers, in front of one and back of one.

Double pairing weave, four weavers, two carried as one, in front of one and back of one.

Triple pairing weave, six weavers, three carried as one, in front of one and back of one.

NUMBER FIVE

TRIPLE WEAVE, ON ANY NUMBER OF SPOKES.

Triple weave, three weavers, in front of two and back of one.

Double triple weave, six weavers, two carried as one, in front of two and back of one.

Triple triple weave, nine weavers, three carried as one, in front of two and back of one.

NUMBER SIX

TWO-PLY WEAVE.

Two-ply weave, four weavers, in front of two and back of two.

NUMBER SEVEN

COLONIAL WEAVE.

Colonial weave, one weaver, in front of two and back of two.

One. Number of spokes divided by four leaving a remainder of two; number of spokes, 18, 22, 26, 30, 34, and 38; change the weave by going back of one.

Two. Number of spokes divided by four leaving a remainder of three; number of spokes, 19, 23, 27, 31, 35, and 39; heavy coil to the right; do not change the weave.

Three. Number of spokes divided by four leaving a remainder of one; number of spokes, 17, 21, 25, 29, 33, and 37; heavy coil to the left; do not change the weave.

NUMBER EIGHT

BELLEFONTE WEAVE.

Bellefonte weave, one weaver, in front of one and back of three.

One. Number of spokes divided by four leaving a remainder of two; number of spokes, 18, 22, 26, 30, 34, and 38; every other spoke exposed.

Two. Number of spokes divided by four leaving a remainder of three; number of spokes, 19, 23, 27, 31, 35, and 39; heavy coil to the right.

Three. Number of spokes divided by four leaving a remainder of one; number of spokes, 17, 21, 25, 29, 33, and 37; heavy coil to the left.

140. (b) COILS

3 rod coil.	3 weavers.	In front of 2, back of 1	
4	4	“	3, “ 1
*4	4	“	2, “ 2
5	5	“	4, “ 1
5	5	“	3, “ 2
6	6	“	5, “ 1
6	6	“	4, “ 2
*6	6	“	3, “ 3

*Coil inside and out.

141. ARROWS

ONE

*Pairing arrow. Two weavers. Twice the circumference.**Double pairing arrow. Four weavers. Two carried as one. Twice the circumference.**Triple pairing arrow. Six weavers. Three carried as one. Twice the circumference.*

Two

*Triple arrow. Three weavers. Twice the circumference.**Double triple arrow. Six weavers. Two carried as one. Twice the circumference.**Triple triple arrow. Nine weavers. Three carried as one. Twice the circumference.*

THREE

*Four-rod arrow. Four weavers. Twice the circumference.**Double four-rod arrow. Eight weavers. Two carried as one. Twice the circumference.**Triple four-rod arrow. Twelve weavers. Three carried as one. Twice the circumference.*

(c) SCALE OF MEASUREMENTS FOR MODELS
GIVEN IN THE TWELVE LESSONS

	BASE	HEIGHT	GREATEST DIAMETER	OPENING
1. Work-basket, straight sides.	3	3	5½	5½
	4	4	7½	7½
	5	5	9½	9½
2. Work - basket, bowl-shaped.	3	3	6	5
	4	4	8	7
	5	5	10	9
3. Handle basket, round.	3½	5½	8½	6½
	4	6½	10½	8½
	4½	7½	12½	10½
4. Handle basket, pear-shaped.	3½	8	8½	6
	4	9	9½	6
	4½	10	10½	6
5. Handle basket, lily-shaped.	3½	6 or 7	10	10
	4	8	12	12
	4½	9	14	14
6. Candy basket, straight sides.	3½	4	6	6
	4	5	7	7
	4½	6	8	8
7. Candy basket, bowl-shaped.	3½	3½	5½	5
	4	4	6½	6
	4½	4½	7½	7
8. Table jardinières.	3½	3½	8	7
	4½	4½	9	8
	5½	5½	10	9
	6½	6½	11	10
9. Violet bowls.	3	3¾	6½	2¾
	3½	4¼	7½	3¾
	4	4¾	8½	4¾
10. Scrap basket, Model 18.	6	11	13	10*
	6½	12	14	10†
	7	13	15	10‡
11. Scrap basket, Model 19.	7½	7½	14	9§
	8	8	15	9
	8½	8½	16	9¶
12. Culling - flower baskets.	5x7	5	15x17	15x17
	6x8	5½	17x19	17x19
	7x9	6	19x21	19x21

* Turn shoulder at nine inches high. † Turn shoulder at ten inches high.

‡ Turn shoulder at eleven inches high.

§ Turn basket in when diameter is thirteen inches.

|| Turn basket in when diameter is fourteen inches.

¶ Turn basket in when diameter is fifteen inches.

142. (d) BORDERS

(a) BORDER NO. 1.

First row, back of one and out.

Second row, in front of two and in; or in front of three and in.

Third row, in front of two and down.

BORDER NO. 2.

First row, back of two and out.

Second row, in front of two and in; or in front of three and in.

Third row, in front of two and down.

BORDER NO. 3.

First row, back of three and out.

Second row, in front of two and in; or in front of three and in.

Third row, in front of two and down.

(b) COMMERCIAL BORDER NO. 1.

(a) Lay down two spokes.

(b) In front of one spoke, back of one and out, and lay the first standing spoke.

(c) Carry the short ends, in front of one spoke, to the inside of the basket.

COMMERCIAL BORDER NO. 2.

(a) Lay down three spokes.

(b) In front of two spokes, back of one and out, and lay down the first standing spoke.

(c) Carry the short ends, in front of two spokes, to the inside of the basket.

COMMERCIAL BORDER No. 3.

- (a) Lay down four spokes.
- (b) In front of three spokes, back of one and out, and lay the first standing spoke.
- (c) Carry the short ends, in front of three spokes, to the inside of the basket.

COMMERCIAL BORDER No. 4.

- (a) Lay down five spokes.
- (b) In front of four spokes, back of one and out, and lay the first standing spoke.
- (c) Carry the short ends, in front of four spokes, to the inside of the basket.

(c) SCRAP-BASKET BORDER No. 1.

- First row*, in front of two and in.
- Second row*, over two and down.

SCRAP-BASKET BORDER No. 2.

- First row*, in front of three and in.
- Second row*, over two and down.
- A third row may be added; over two and down.

CHAPTER XV

ANSWERS TO QUESTIONS

Answer to Question One:

The weaving over the spokes in the base before they are separated.

Answer to Question Two:

The second spoke in the threads to the left of the first angle (angle *a*).

It is a thread.

Answer to Question Three:

To separate the side spokes, inserted in a base, an equal distance apart.

Answer to Question Four:

A new spoke each side of an old one; *i. e.*, two new spokes against each original spoke.

Answer to Question Five:

A three-rod coil is only one row of triple weave and is reversed and locked.

Triple weave may be any number of rows and the weaving is not reversed at the initial spoke and is not locked.

Answer to Question Six:

Reversing the weaving at the initial spoke.

Locking the weaving at the initial spoke.

Answer to Question Seven:

The locking of the coil.

Answer to Question Eight:

Stroke that passes in front of two spokes.

Answer to Question Nine:

The first weaver passes over two spokes and back of one. The second weaver is inserted back of the spoke to the right of the one containing the first weaver and passes over one spoke and back of one; thus the two weavers pass back of the same spoke.

Answer to Question Ten:

The spokes of any row must all be the same distance from the button, and they must be an equal distance apart.

Answer to Question Eleven:

Four needles and four threads.

Answer to Question Twelve:

No.

Answer to Question Thirteen:

The number of spokes between the handle-bar on each side of the basket would not be the same. Therefore the handle would be crooked in the basket.

Answer to Question Fourteen:

Half the total number of spokes used. Over-and-under weave.

Answer to Question Fifteen:

It can be pushed through to the other side of the button and held firmly by the needles.

Answer to Question Sixteen:

First. Each stroke passes back of the spoke to its right and out.

Second. In front of the first standing spoke to the right and in.

Third. Back of the second standing spoke and out.

Fourth. In front of one spoke and in, ending on the inside of the basket.

Answer to Question Seventeen:

Along the side spoke to the left of the middle thread, on the side of the button containing the three threads.

Answer to Question Eighteen:

The right handle-bar will be inserted on the opposite side along the side spoke, to the left of the right-hand thread.

The left handle-bar will be inserted on the opposite side along the side spoke, to the right of the left-hand thread.

Answer to Question Nineteen:

The principle is the same in both bars. In coming back on the first bar the weavers fell to the left or below the weavers of the first winding. Therefore on the second bar the necessary space to the left must be allowed.

Answer to Question Twenty:

The finished lid must measure one fourth of an inch less than the diameter of the opening of the basket.

Diameter of lid must be six and three eighths inches, as the lid border measures three eighths of an inch on each side or a total of three quarters of an inch. Six and three eighths inches less three fourths of an inch

gives five and five eighths inches for diameter of the weaving of a lid before the border is completed. ($6\frac{3}{8} - \frac{3}{4} = 5\frac{5}{8}$.)

Answer to Question Twenty-one:

Pairing.

Over and under; two weavers.

Double over and under.

Single Japanese.

Double Japanese.

Triple.

Two-ply.

All coils.

Colonial and Bellefonte weaves cannot be used.

Answer to Question Twenty-two:

Pairing.

Over and under; two weavers.

Double over and under.

Triple.

All coils.

Colonial.

Bellefonte.

Japanese single or double cannot be used.

Answer to Question Twenty-three:

Six in each group.

Answer to Question Twenty-four:

No.

Under the lower vertical group.

Answer to Question Twenty-five:

(a) Japanese.

(b) Pairing, over and under, double Japanese.

(c) Three-rod coil, triple weave, triple Japanese.

Answer to Question Twenty-six:

- (a) Over and under.
- (b) Pairing, double over and under, double Japanese.
- (c) Three-rod coil, triple weave, triple over and under.

Answer to Question Twenty-seven:

- (a) Japanese, Bellefonte, Colonial.
- (b) Pairing, over and under, double Japanese.
- (c) Three-rod coil, triple weave, triple Japanese.

Answer to Question Twenty-eight:

No.

The border goes in front of two and forms an arrow with the coil.

Answer to Question Twenty-nine:

Supporters being omitted, requires more spokes, so that they will not be too far apart.

Able to use one weaver in over-and-under weave.

Answer to Question Thirty:

Round base has a button.

Oval base has a spine.

Oval base has supporters.

Oval base carries needles in pairs as one spoke.

Answer to Question Thirty-one:

Spokes in basket would be too far apart at the border.

Answer to Question Thirty-two:

Bi-spoke all but the middle needle.

Answer to Question Thirty-three:

As many spokes as weavers.

Pairing, two; in front of one and back of one.

Triple, three; in front of two and back of one.
 Four-rod coil, four; in front of three and back
 of one.

Answer to Question Thirty-four:

Over and under, two weavers; all kinds.
 Pairing; all kinds.
 Triple.
 All coils.
 Japanese; all kinds.

Answer to Question Thirty-five:

Needles, threads, and supporters with the winds
 between the needles.

Answer to Question Thirty-six:

No.
 The initial spoke of the spine is the upper left-
 hand needle.
 The initial spoke of an oval base is the lower
 left-hand thread.

Answer to Question Thirty-seven:

In over-and-under weave the weavers never cross
 each other.

In pairing the weavers cross each other in be-
 tween the spokes.

INDEX

A

	PARAGRAPH
American Rattan & Reed Mfg. Co.....	I
Arrow.....	6-8, 19, 141

B

Base.....	32, 36
Base spokes.....	5-a
Base with thirteen spokes.....	57-1, 58
Basket with simple handle.....	46
Bellefonte weave.....	57-3, 61, 139
Border.....	22-d, 142
Border No. one.....	41, 142-a
Border No. two.....	52, 142-a
Border No. three.....	142-a
Bowl-shaped basket.....	44, 141
Button of base.....	35

C

Candy baskets.....	82, 141
Coil.....	6-7, 15, 140
Colonial weave.....	57-2, 59, 139
Commercial border No. one.....	70, 142-b
Commercial border No. two.....	80, 142-b
Commercial border No. three.....	142-b
Commercial border No. four.....	142-b
Correct and incorrect base spokes.....	116
Correct and incorrect side spokes.....	117, 119
Culling-flower baskets.....	134, 141

D

Definitions.....	5
Directions for measuring a base.....	31-a
Directions for measuring a basket.....	31
Directions for measuring the diameter of a basket.....	31-d
Directions for measuring the height of a basket.....	31-b
Directions for measuring the opening of a basket.....	31-c
Double Japanese weave.....	6-4, 11, 139

	PARAGRAPH
Double over-and-under weave.....	6-2, 9, 139
Double weaving.....	21
F	
Five-rod coil.....	15-c, 140
Flower baskets with handles.....	56, 73, 141
Foot rule.....	2-7
Four-rod coil.....	15-b, 140
G	
Gathering baskets.....	136, 141
General rule for weaving.....	7
H	
Handle for beginners.....	47, 49
Handle (Japanese).....	53
Handle (split).....	75-78
I	
Indian centres.....	93, 102
Initial spoke.....	5-c
Initial spoke of an arrow.....	39
Initial spoke of a base.....	35, Fig. 3, No. 3
Initial spoke of an oval base.....	127
J	
Japanese handle.....	53
Japanese weave.....	6-3, 10, 139
Jardinière for table.....	110, 112, 141
L	
Lay-down spokes.....	70-1
Lid.....	87
Lid basket.....	82, 90, 141
Lid border.....	88
Lift on lid.....	89
Lily-shaped flower basket with handle.....	141, 56, 64, 69
M	
Market basket.....	129
Materials.....	1
Measurements of four flower baskets.....	74
Mending.....	22-c
Mending an arrow.....	30

INDEX

109

	PARAGRAPH
Mending Bellefonte weave.....	61
Mending a coil.....	29
Mending Colonial weave.....	60
Mending double Japanese weave.....	27
Mending double Japanese weave (wrong side out).....	135
Mending double over-and-under weave.....	25
Mending Japanese weave.....	26
Mending over-and-under weave.....	23
Mending pairing weave.....	24
Mending single Japanese weave (wrong side out).....	135
Mending triple weave.....	28
Mending two-ply.....	62
Model No. one.....	37, 42
Model No. two.....	43
Model No. three.....	44
Model No. four.....	46
Model No. five.....	51
Model No. six.....	54
Model No. seven.....	54
Model No. eight.....	56, 64, 69
Model No. nine.....	74-9
Model No. ten.....	74-10
Model No. eleven.....	74-11
Model No. twelve.....	74-12
Model No. thirteen.....	82
Model No. fourteen.....	83
Model No. fifteen.....	84
Model No. sixteen.....	107
Model No. seventeen.....	108
Model No. eighteen.....	120
Model No. nineteen.....	122, 123
Model No. twenty.....	124
Model No. twenty-one.....	129
Model No. twenty-two.....	130
Model No. twenty-three.....	134
Model No. twenty-four.....	136

N

Needles of an oval base.....	126, Diagram 24
Needles of a round base.....	34
New England Reed Co.....	1
New propositions.....	57, 92

O

Opening of a basket.....	22-c
Oval base.....	126, 127

	PARAGRAPH
Oval basket.....	126, 130, 141
Oval basket with handles.....	130
Oval culling-flower basket.....	134, 141
Oval flower basket.....	134, 136, 141
Oval gathering basket.....	136, 141
Over-and-under weave.....	6-1, 8, 139
Overspoked basket with standard.....	104, 107, 110
P	
Pairing.....	6-5, 12, 139
Pairing arrow.....	105, 106, 141
Pincers.....	2-3
Preparation of reed.....	4
Q	
Questions No. one to ten.....	45
Questions No. eleven to thirteen.....	55
Questions No. fourteen to seventeen.....	72
Questions No. eighteen to nineteen.....	81
Questions No. twenty to twenty-two.....	91
Questions No. twenty-three to twenty-four.....	113
Questions No. twenty-five to twenty-seven.....	121
Questions No. twenty-eight to twenty-nine.....	125
Questions No. thirty to thirty-two.....	133
Questions No. thirty-three to thirty-seven.....	138
R	
Rattan.....	1
Reversing a coil.....	15- <i>c</i>
Rule for handle basket.....	63
Rule for oval base.....	128
Rule for round bases.....	33
S	
Scale of measurements.....	141
Scrap baskets.....	120, 122, 123, 124, 141
Scrap-basket border.....	120- <i>m</i>
Scrap-basket border No. one.....	142- <i>c</i>
Scrap-basket border No. two.....	142- <i>c</i>
Shoulder of a basket.....	22- <i>b</i>
Side cutters.....	2-2
Side spokes.....	5- <i>b</i>
Sloyd knife.....	2-1
Spine of an oval base.....	35-Fig. 3, No. 3
Split handle.....	75

INDEX

111

	PARAGRAPH
Spokes.....	5
Standard.....	109, 112
Stroke.....	5-8
Supporters.....	126, 127

T

Table jardinières.....	110, 112, 141
Tape measure.....	2-6
Terms.....	22
Threads of an oval base.....	126, Diagram 24
Threads of a round base.....	34
Three-rod arrow.....	19
Three-rod coil.....	15- <i>a</i>
Tools.....	2
Triple weave.....	6-6, 13, 139
Turn of a basket.....	22- <i>a</i>
Two-ply.....	57-4, 62, 139

V

Variations in measurements (in same model).....	73, 74
Variations of basket No. one.....	65
Variations of basket No. two.....	66
Variations of basket No. three.....	67
Variations of basket No. four.....	68
Variations of weaver (in same model).....	56, 69
Violet bowl.....	107, 141

W

Weavers.....	5- <i>e</i>
Weaves.....	6, 139
Weaving of a base.....	36
Winding awl.....	3
Winding of a split handle.....	76
Work-basket Model No. one.....	37, 42, 141
Work-basket Model No. two.....	43, 141