

TEXT-BOOKS OF TECHNOLOGY

EDITED BY

PROF. W. GARNETT, D.C.L., AND PROF. J. WERTHEIMER,
*Secretary of the Technical Education Board
of the London County Council and for-
merly Principal of the Durham College
of Science, Newcastle-on-Tyne.* B.Sc., B.A., F.I.C., F.C.S.,
*Principal of the Merchant Venturers'
Technical College, Bristol.*

AN INTRODUCTION TO THE STUDY OF TEXTILE DESIGN

TEXT-BOOKS OF TECHNOLOGY

Edited by Professor W. GARNETT, D.C.L., Secretary of the Technical Education Board of the London County Council, and Professor J. WERTHEIMER, B.Sc., B.A., F.I.C., F.C.S., Principal of the Merchant Venturers' Technical College, Bristol.

Messrs. Methuen and Co. are issuing a series of elementary books under the above Title. They are specially adapted to the needs of Technical Schools and Colleges, and fulfil the requirements of Students preparing for the Examinations of the City and Guilds of London Institute.

The prices vary according to the size of the Volumes, which are suitably illustrated, and are provided with numerous examples and examination papers.

The following books are ready :

- PRACTICAL CHEMISTRY.** By W. FRENCH, M.A., Principal of the Storey Institute, Lancaster. Crown 8vo. Second Edition. Part I. 1s. 6d.
- PRACTICAL MECHANICS.** By S. H. WELLS, Principal of the Battersea Polytechnic Institute. Crown 8vo. Second Edition. 3s. 6d.
- PRACTICAL PHYSICS.** By H. STROUD, D.Sc., M.A., Professor of Physics in the Durham College of Science, Newcastle-on-Tyne. Crown 8vo. 3s. 6d.
- CARPENTRY AND JOINERY.** By F. C. WEBBER, Chief Lecturer to the Building Trades' Department of the Merchant Venturers' Technical College, Bristol. Crown 8vo. Third Edition. 3s. 6d.
- HOW TO MAKE A DRESS.** By Miss WOOD, Chief Instructress at the Goldsmiths' Institute, New Cross. Crown 8vo. Second Edition. 1s. 6d.
- MILLINERY, THEORETICAL AND PRACTICAL.** By Miss C. HILL, Instructress to the West Riding County Council and the Leeds School Board. Crown 8vo. 2s.
- TECHNICAL ARITHMETIC AND GEOMETRY FOR USE IN TECHNICAL INSTITUTES.** By C. T. MILLIS, M.I.M.E., Principal of the Borough Polytechnic Institute, London. Crown 8vo.
- AN INTRODUCTION TO THE STUDY OF TEXTILE DESIGN.** By A. F. BARKER, Head of the Department of Textile Industries, Bradford Technical College. Demy 8vo. 7s. 6d.

The following books are in preparation :

- PAINTING AND DECORATING.** By W. S. PEARCE, Lecturer in the Municipal Technical School, Manchester.
- THE GEOLOGY OF COAL.** By G. A. LEBOUR, M.A., F.G.S., Professor of Geology in the Durham College of Science, Newcastle-on-Tyne.

AN INTRODUCTION TO
THE STUDY OF
TEXTILE DESIGN

BY

ALDRED F. BARKER

•HEAD OF THE DEPARTMENT OF TEXTILE INDUSTRIES,
BRADFORD MUNICIPAL TECHNICAL COLLEGE

WITH NUMEROUS ILLUSTRATIONS AND DIAGRAMS

METHUEN & CO.
36 ESSEX STREET W.C.
LONDON

1903

CONTENTS

CHAPTER	PAGE
LIST OF ILLUSTRATIONS	vii
PREFACE	xi
INTRODUCTORY REMARKS	xiii
I. SIMPLE INTERLACINGS	I
II. THE PREPARATION OF THE WARP FOR THE LOOM AND THE ELEMENTS OF WEAVING	19
III. THE HAND AND THE POWER LOOM	40
IV. THE SCIENCE AND ART OF CLOTH CONSTRUCTION	58
V. THE DESIGNING OF INTERLACINGS ON POINT-PAPER	94
VI. SATEEN FIGURES	130
VII. THE PRINCIPLES OF DRAFTING	146
VIII. THE STRUCTURE AND CORRECT USE OF YARNS	165
IX. ANALYSIS AND SYNTHESIS, ILLUSTRATED BY COLOUR AND WEAVE STYLES AND BACKED AND DOUBLE- CLOTH STRUCTURES	169
X. THE MANUFACTURE OF LUSTRE GOODS	195

APPENDIX

ELEMENTARY YARN CALCULATIONS	200
" CLOTH " 	202
" DESIGNING " 	204
ADVANCED YARN AND CLOTH CALCULATIONS	207
INDEX	209

FIG.	PAGE
21A. and 21B. Warp Dressing	<i>To face</i> 36
22. Drawing-in a Warp	" 38
23. Standard Sizes of Reed Hooks	" 38
24. Sleying a Warp	" 38
25. Twisting or Tying-in the Loom	" 38
26. Hand Treadle-loom	42
27. Bottom-shed Witch or Dobby Hand-loom	44
28. Design and Pegged Lags	46
28A. Design and Pegged Lags for Dobcross Loom	47
29. Centre-Shed Witch or Dobby Hand-loom	48
30. General View of Tappet Loom	50
31. Section of Tappet Loom	51
32. Dobby Loom, Under-swung	52
33. Letting-off Motion, Regulated by Warp Tension	54
34. Jacquard Loom	56
35. Graphic Illustrations of Yarn Counts	60
36. (A to F) Graphic Illustrations of the Twisting of Yarns	65
37. Graphic Illustration of Changes in Areas and Diameters	70
38. Graphic Illustration of the Counts, Lengths, Areas, and Diameters of Yarns	72
39. The Angle of Curvature in a Plain Cloth	74
40. The Angle of Curvature in a $\frac{2}{2}$ Twill Cloth	74
41. A Weft-Rib Cloth : Plan and Section	82
42. $\frac{2}{2}$ Twill as a Weft-rib Structure	84
43. Graphic Illustration of the Calculation for the Weight of a Warp	88
44 and 45. Graphic Illustrations on Changing the Weights of Fabrics	91
46. Illustrations of Twisting and Twilling	101
47. Herring-bone or Chevron Effect	102
48. Graphic Illustration of the Counts of Yarns	202
49. Plan and Section of a Sateen Cloth	115
50. The Divisions of Space in Various Sateen Orders	137
51. The Influence of Lag-Pegging, Position and Working of the Dobby, and the Draft on the Direction of the Twill in the Cloth	151
52. Various Systems of Indicating the Draft	156
53. Plan and Section of Double Cloth	188
54. Graphic Illustration of Casting-out in Gears	166
55. Illustrating Right and Left Step Pattern Figuring	175

LIST OF ILLUSTRATIONS

ix

LIST OF PLATES : POINT-PAPER PLANS AND FABRICS

PLATE	PAGE
1. Illustrating Plain, Hop-sack, Twill, and Crape Structures	20
2. Illustrating the Difference between Twill, Warp-rib and Weft-rib	76
3. Illustrating the Construction of Compound Twills	104
4. Illustrating the Rearrangement of Twills	111
5A. Illustrating the Construction of an Ordinary Sateen Twill	128
5B. Illustrating the Construction of an Upright Sateen Twill	131
6. Illustrating the Construction of a Sateen Check and a Sateen Diaper	135
7. Illustrating Colour and Weave Effects	174
8. Illustrating the Correct Tying of Backed or Double Cloths	186
9. Illustrating Double Plain Cloth Modifications	189

LIST OF POINT-PAPER DESIGN SHEETS

DESIGN SHEET	PAGE
1. Standard Weaves	23
2. Plain Weave Developments	96
3. Simple Twill Origination	99
4. The Repetition of Weaves	103
5. Compound Twills	105
6. Combination Twills	106
7. Crape Weaves	109
8. The Rearrangement of Twills	112
9. Combinations and Permutations	114
10. The Origination of Sateens	116
11. " " "	118
12. " " " up to Sixteen	120
13. The Origination of Regular and Irregular Sateen Derivatives	122
14. Motive Weave Effects	125
15A. Twill Rearrangement	126
15B. " "	127
16. Sateen Twills	129
17A. The Completion of Weaves	132
17B. " " "	134

LIST OF ILLUSTRATIONS

DESIGN SHEET	PAGE
18. Sateen Stripes and Checks	136
19. Sateen Diapers	138
19A. " "	139
20. The Arrangement of Figures in Sateen Order	140
20A. " " " "	141
20B. " " " "	144
20C. " " " "	147
20D. " " " "	148
20E. " " " "	149
21. Illustrating Drafting	152
21A. " "	153
21B. " "	154
21C. " "	157
22. Colour and Weave (Analysis)	176
22A. " " (Synthesis)	177
22B. " " (Analysis)	178
22C. " " (Synthesis)	180
22D. " " " "	182
22E. " " " "	183
23. Double Cloths (Synthesis)	185
23A. " " " "	187
24. " " (Analysis)	190
24A. " " " "	191
24B. " " " "	192
25. Illustrating Effective and Ineffective Textile Design	193

P R E F A C E

THIS work includes within its pages the information which the student of Textile Design should seek to thoroughly master during the first two years he attends the Textile School. Some of the information is new, much is in one sense old; but all is placed before the student in such a way that not only is the necessary knowledge gained, but also that mental capacity which is absolutely necessary if trade changes—which now come upon us day by day—are to be satisfactorily faced and made the basis of success rather than of failure.

A series of examination papers of considerable educational value is given in the appendix. When the student can clearly and concisely answer these he will have so trained himself that this book may be dispensed with. He will, further, have laid a sound foundation upon which to build in the future, whatever may be the particular branch of the textile industries he elects to work in.

The author's thanks are due to Messrs. A. M. Bell,

T. Barrett, F. W. Barwick, E. Priestley, and several others of the staff and students of the Textile Industries Department of the Bradford Municipal Technical College for valuable assistance in preparing the work for the press.

A. F. B.

BRADFORD MUNICIPAL TECHNICAL COLLEGE.

INTRODUCTORY REMARKS
AND
INSTRUCTIONS TO THE READER

ALL instruction has two values :*

1. As absolute knowledge.
2. As discipline.†

Elementary and secondary education, although in part necessarily concerned with absolute knowledge, are principally engaged in discipline—*i.e.*, in the right development of the individual and in conformation to type.

Technical education is supposed by many to deal simply with absolute knowledge and physical training.‡

No greater fallacy than this can well be imagined.

If industries were stationary, and did not develop or evolve, absolute knowledge might be the royal road to advancement in commercial life, and there would be no such thing as technical education ; there would only be technical instruction, which might be defined as the imparting of the accumulated knowledge respecting any industry. Such was technical instruction in its early

* See Mr. Herbert Spencer's work on 'Education.'

† That is true education if the discipline results in development on all planes of human activities.

‡ See Huxley's Science and Education Essays, 'Technical Education.'

stages, when thousands of students (*sic*) congregated to be *told* secrets which would make them into merchant princes. Now, there is really a 'slump' simply because technical instructors have told too many of these money-making secrets which, through their wholesale distribution, have become, as special knowledge, valueless.

But this same information—*rightly imparted*—may not only in itself be valuable to the student, but may also be made the basis of a most useful and truly educational discipline.

Just as the child requires the absolute knowledge of the alphabet and of the atmosphere of humanity, so does the youth require the alphabet of the industry in which he is to work, and the absolute knowledge—both mental and physical—upon which the industry, or perhaps his own particular branch of it, is based. But few students can gain this knowledge—which will only maintain the *status quo*—by being *told* it; *each student must acquire it for himself*, and its acquisition depends upon the development of the student's own physical and intellectual senses. Now, the moment the development of the individual is admitted, the value of discipline—in contrast to mere information—of education as distinct from mere instruction, must also be admitted.

The primary object of this work is to show clearly how the special knowledge required in the Textile Industries may be co-ordinated into a truly educational discipline—a discipline using the knowledge of value for to-day in such a way that the student himself will be a better man to-morrow.

When the perpetual development of trade is realized, it will be evident that, whilst absolute knowledge *is*

essential, still more is it essential that the youth should be disciplined in such a way that he can face trade changes with confidence, and push out into unexplored fields of physical and mental activities to the ultimate advantage of himself and of his fellow-men.

From another point of view—that of commercial life—the question of discipline is paramount. Given the necessary absolute knowledge and physical qualifications, it is, after all, *character* which tells. Now, it is a strange kind of reasoning which asserts that character can be better built up by reading of past heroic ages, or even of past scientific achievements, rather than by a well-regulated life in the actual present. The few only have the gift of living in the past, and therefrom drawing lessons for the present, and it is a deplorable mistake to base the education of the many on the requirements of the few—almost as bad as to base the education of the few on the requirements of the many.* If our technical schools are organized as they should be, they will not be mere emporiums of facts, but living centres of human activities, stimulating and invigorating the youths of to-day, who will be the commercial leaders of to-morrow, and developing the faculties of accuracy, reasonableness, smartness, and application, which are the pass-words to success.

To develop the innate capabilities of the student through the industry in which he must work should be the desideratum of education in industrial centres, since the two-fold advantage is obtained of—

(a) The absolute knowledge necessary for earning a livelihood ; and

* Hence, also, the folly of endeavouring to graft German or American educational methods on to our English system, or *vice versa*.

(b) The discipline which will enable the student to realize to the full his own innate capabilities.*

With these points in view, no apology is necessary from the author for writing this work *in terms of the student* and not of the industry.

Many think that industries are a necessary evil ; this book is written as a protest against this attitude, in the hope that it may assist in the development of the textile industries towards that state of efficiency in which life in these industries may become a pleasure rather than a burden. Such a state may be far distant, but the author will feel that his time in writing this work has not been thrown away if it results in those engaged in the industry realizing the absorbing interest of many of the problems which must be faced.

In order that the student may spend his time to the best advantage, reap the greatest benefit, and develop a progressive interest in his work, he is strongly recommended to pay special attention to the following points :

1. Read carefully, and be sure that you understand every word ; many most important points are hidden from the casual reader which the *careful reader* cannot fail to realize.

2. Study the diagrams and point-paper plans very carefully ; each one usually explains itself and suggests much more than is given in the text.

3. Never accept a statement without realizing truly what it means. Be *reasonable* in all your work and thoughts.

* These innate capabilities being frequently evolved after college life, the technical college can do little for him *directly*, but by discipline it may *indirectly* do much.

4. Endeavour to work in stages from the simple to the complex. Difficulties which are apparently unsurmountable become quite easy when approached by studies running in *sequence* from the simple to the complex.

5. Test yourself to insure accuracy in your work by repeating designs, or in any way which occurs to you ; without accuracy you can do nothing.

6. In carrying out designs (after you have *carefully* done the scheming) always work at high tension for a short time rather than slackly for a long time.

7. In all designing arrange to work to the greatest advantage and *quickly* ; if you make two strokes at every square instead of one the design will take double the time it should take.

8. Finally, remember that if it is true that 'A bad workman quarrels with his tools,' it is even truer that '*A good workman employs good tools.*'

AN INTRODUCTION TO THE STUDY OF TEXTILE DESIGN

CHAPTER I

SIMPLE INTERLACINGS

IN the study of textile fabrics, as in many other studies, the first essential is an all-round knowledge of the subject; an appreciation of the general before proceeding to the particular. It cannot be denied that the present-day tendency is to specialize, but this really emphasizes the value of an all-round knowledge as part of the specialist's equipment; for, in order that he may work to the greatest advantage, he must have some knowledge of all the surrounding influences bearing upon his own particular work, and he must be able to gain this knowledge with the least possible expenditure of time and energy; hence the value of our technical schools and technical education. In these schools specially arranged experiences are gone through, and these experiences, with the experiences of practical commercial life, are integrated into a science of the textile industries—*i.e.*, the conserved experience not merely stored up, but stored up in a form ready to be used with precision.

The textile designer, then, should at least have a good

general knowledge of all textile structures before proceeding to specialize, and he should also be trained to apply the experiences gained by others to his own particular work and advantage. This aspect of the student's training will be noted from time to time in the following pages as opportunity offers.

TEXTILE FABRICS GENERALLY CONSIDERED

The principal structures are the following :

1. Felt structures.
2. Knitted structures.
3. Woven structures.
4. Lace structures, etc.*

Felt is given first in the above list, and lace comes last, as this is probably the natural sequence. One would imagine that the matting of wool fibres together would be naturally suggested to the parents of our race emerging from the barbarous state, and that they would endeavour to fashion some sort of clothing on the lines thus suggested.

To-day the felt industry is a very large one, comprising the making of felt hats, table-covers, curtains, carpets, etc. The operations in making felt are few and comparatively simple.

A wool with a strong tendency to felt is fed into an ordinary carder, it is taken out in a broad semi-transparent film, say 80 inches wide, then, by a suitable continuous arrangement, film is laid upon film until a bed of fibres, say 20 yards long, 80 inches wide, and several inches

* Embroideries and appliqué work come under the heading Ornamentation, not Structure.

thick—according to the required thickness of the resultant felt—is formed. This is ‘milled’ or beaten up, and forms the ‘felt’ cloth or baize as placed on the market. Briefly, it may be defined as *fibre structure*, as distinct from *thread structure*, in every other case.

Knitted fabrics present greater variety than felts; stockings, stockinette coatings, curtains, hosiery, and a great variety of fabrics for ladies’ wear are produced on this principle. In this case the ordinary method of knitting or crocheting is employed—viz., the principle of interlacing one thread with itself—hence by pulling at one thread usually the whole structure may be unravelled. The knitting-frame is usually circular in form, and the recently introduced Millar loom is really on the knitting principle with two additional series of threads at right angles.

Woven fabrics are by far the most important structures produced, including a great variety of fabrics for men’s and women’s wear, in addition to tapestries, plushes, gauzes, etc. The principle upon which they are made is very simple. The usual definition of a woven fabric is: *Two series of threads which cross one another at right angles and interlace with one another according to the style of structure required.* There are, however, several varieties or modifications, such as plush and gauze, which will require special explanation.

Again, lace structures are possibly the most complex of all. Curtains and laces of all descriptions are included in this class. The principle upon which these are made is somewhat analogous to that of knitted structures, but in this case several threads or series of threads are employed

and passed round one another in a most bewildering way to the uninitiated. Needless to say, however, there is absolute order from beginning to end in every machine-made lace pattern.*

Having thus briefly stated the principles involved in all textile structures, attention must now be particularly directed to the most important class—viz., woven structures.

WOVEN STRUCTURES

These may be conveniently studied under the following heads :†

1. Ordinary woven structures.
2. Plush structures.
3. Gauze and Lappet structures.

Ordinary woven structures fulfil perfectly the definition of a woven fabric previously given—*i.e.*, they are formed by two series of threads crossing one another at right angles and interlacing according to requirements. Sometimes an additional series of threads is added to develop a figure or to add weight to the structure, and sometimes two or more structures are placed together—one on the top of the other—and are bound into one firm and solid cloth; but under any circumstances the foregoing definition is practically true.

The simplest woven fabric, 'plain cloth,' is represented in Fig.1, in which A is termed the plan or flat view, and B the section.

* See Felkin on 'Lace,' and the writer's work on 'Embroideries and Embroidery Machines.'

† If the student has the opportunity he should take a mixed bundle of patterns and endeavour to classify these according to 'material,' 'structure' or 'colour.'

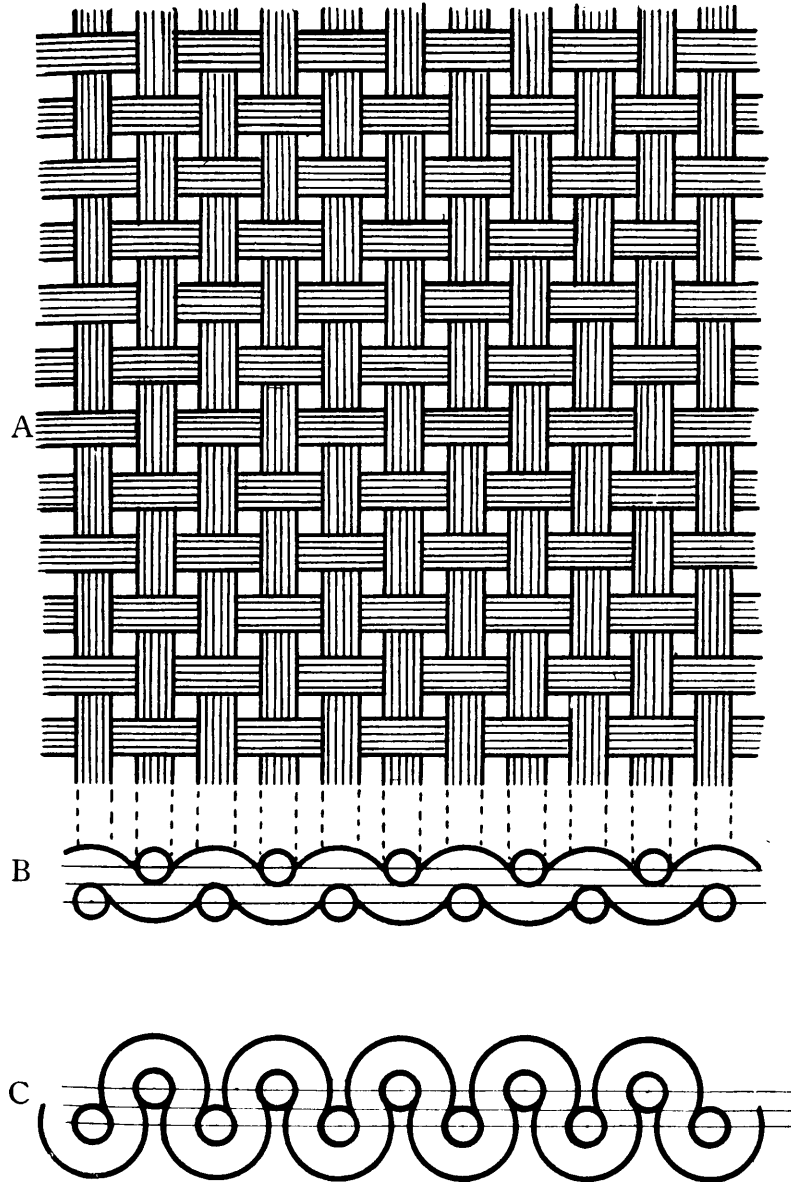

FIG. 1.—ILLUSTRATING PLAIN CLOTH IN PLAN AND SECTION

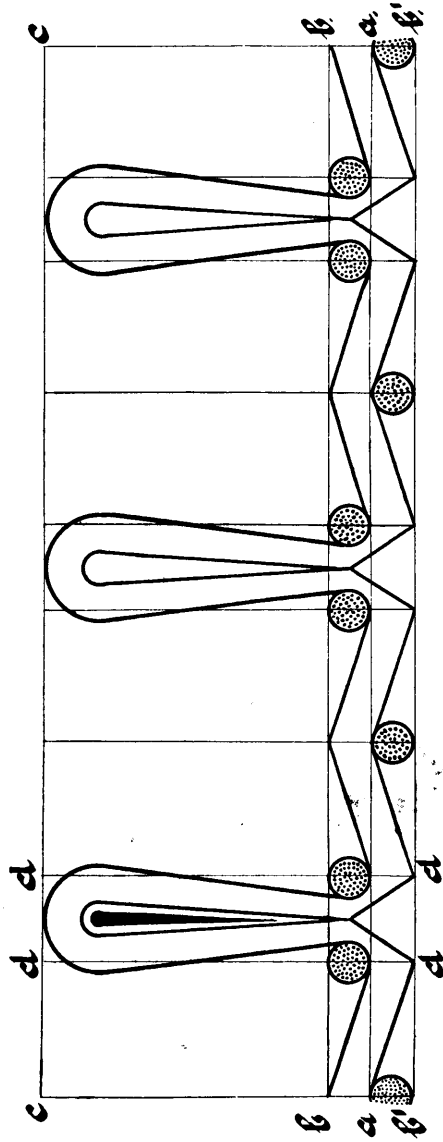

FIG. 2.—DIAGRAMMATIC SECTION OF A PILE FABRIC

Plush structures, however, are not quite true to the definition of a woven fabric, since in addition to an ordinary foundation — say plain cloth — there is another series of threads which stands up from the cloth, and forms what is termed a 'pile.' Fig. 2 represents diagrammatically this style of interlacing in section only, as nothing could well be understood from a flat view.

Gauze structures, like plushes, do not answer perfectly to the definition of woven fabrics. In this case there is usually a foundation cloth, as in the case of plushes, but, in

addition, a series of threads twist round one another in

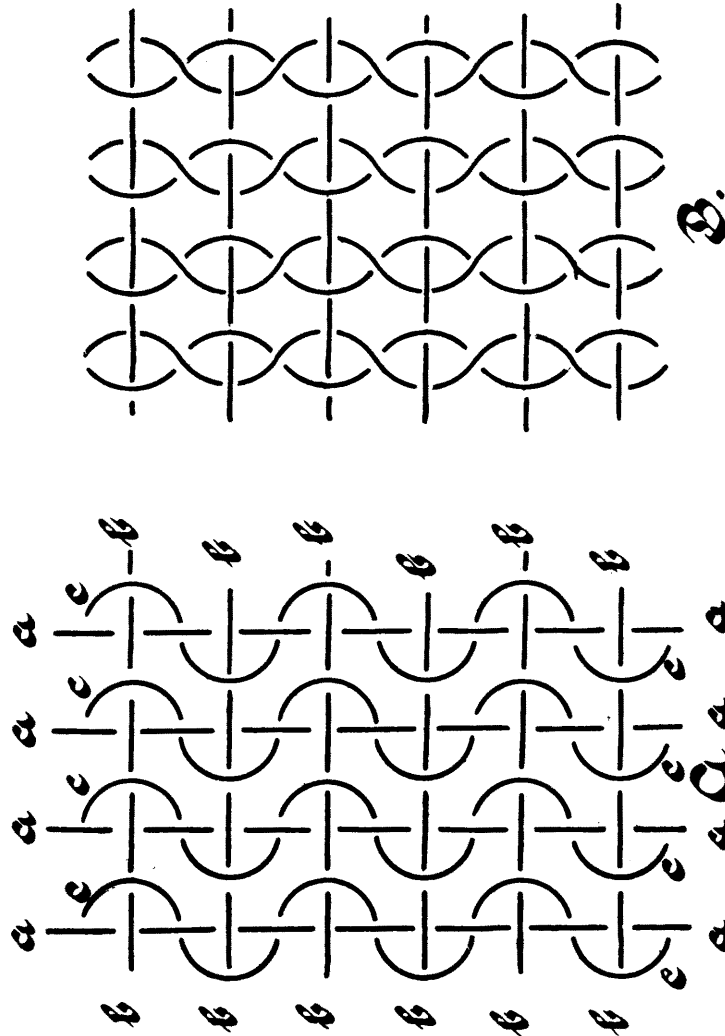

FIG. 3.—ILLUSTRATING AN UNREASONABLE AND A REASONABLE PLAN OF GAUZE

a more or less ingenious way, according to requirements. Fig. 3 is a flat view of the simplest typical gauze; in this case a sectional view is of little or no value.*

* The student as an exercise may endeavour to sketch this.

HINTS ON DRAWING FLAT VIEWS, SECTIONS, ETC.

Before proceeding further the value of making accurate, and *reasonable* drawings such as those given in Figs. 1, 2, and 3 may be further considered with advantage. In Fig. 1, for instance, why should the correct sectional view be B and not C?*

In the planning of this diagram proceed as indicated in Fig. 1A.

1. Rule in lines $x y$ at right angles to one another; from these two lines all measurements are to be made.

2. Rule in line $a a$, representing the centre of the cloth in the sectional view,† and lines $b b$, $b' b'$, representing the centre of the warp threads when up and down respectively.

3. On lines $b b$ and $b' b'$, with compasses, describe the sections of the warp threads in the up and down position alternately, the *centre* of each thread being distant from the centre of its neighbour twice the diameter of the yarn (half warp + weft + half warp).

4. Taking in the compasses one and a half times the diameter of the yarn, describe from the centre of each warp thread (the centre of bending influence) the curve representing the weft.‡

5. Extend the threads from the section to obtain their correct position in the flat view.

* Sectional view C is almost invariably given at one time or another by the beginner. Why is it wrong?

† In order that the student may understand why the flat view is drawn from the section and not *vice versa*, he is referred to Chapter IV., p. 74.

‡ The student should realize that in this case the weft section would be drawn in just the same manner as the warp section.

SIMPLE INTERLACINGS

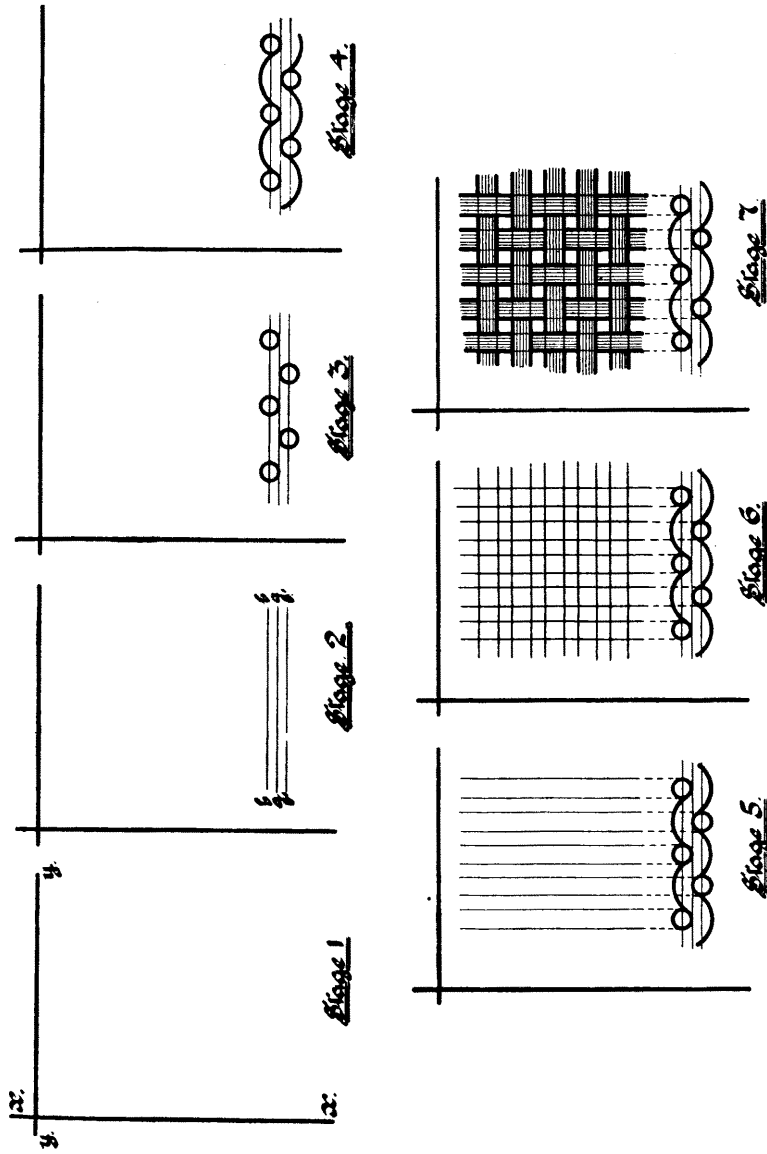

FIG. 1A.—DIAGRAM ILLUSTRATING IN SEVEN STAGES THE CORRECT DRAWING OF THE SECTION AND FLAT VIEW OF PLAIN CLOTH

6. Draw in *lightly* the horizontal threads (picks) the same distance from each other as the vertical threads are.

7. Strongly demark the order of interlacing as indicated.*

It seems almost an absurdity to make seven stages in the drawing of such a simple diagram as Fig. 1, but the student must remember that the right way is always the easiest way in the end. Therefore he should endeavour to draw his diagrams rightly—*i.e.*, accurately, orderly, and neatly—and by so doing he will frequently come across important points which otherwise would escape his observation. In the planning out of Fig. 2† the following order should be adopted: base line, *a a*; lines *b b*, *b' b'*, defining the body of the cloth; line *c c*, defining the height of the pile; lines *d d*, indicating suitable positions of the threads which form part of the ground texture and firmly bind the pile.

In the planning out of Fig. 3‡ the following order should be adopted: Rule in lightly *a a*, *b b*, forming approximate squares; with the point of intersection as centre and half the side of the square as radius draw in the crossing threads *c c*, first at the right side, and then at the left side of the stationary threads *a a*; finally, indicate carefully the intersecting of the horizontal and vertical threads by drawing thicker lines over the thin

* Draw the guiding lines *a*, *b*, *b'*, etc., lightly, and the actual thread strongly, as indicated, to avoid confusion. Red and black ink may also be employed.

† This figure is drawn distinctly as a diagram; it exaggerates certain features present in the actual structure, and for convenience is drawn with straight instead of curved lines.

‡ Be careful that your drawing is reasonable. Why should certain threads bend and others be straight? Examine Fig. 3, A and B, carefully, and decide on the loom mounting to produce each style.

guiding lines.* Fig. 3C represents the necessary stages in drawing this flat view.

The Use of Point-Paper.—As already pointed out, woven fabrics are composed of two series of threads

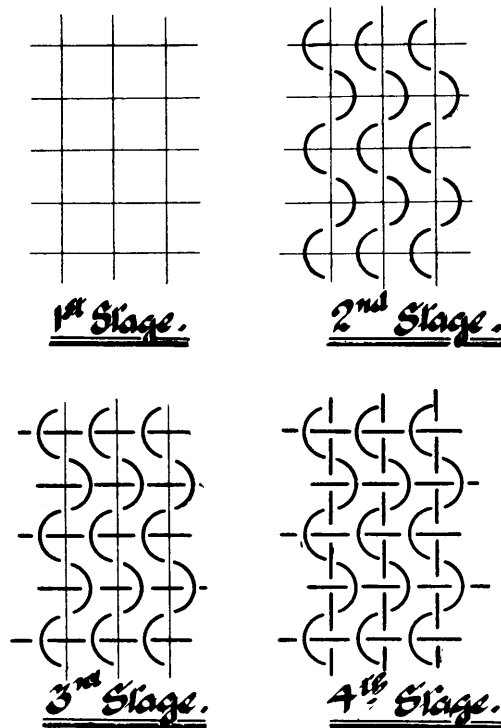
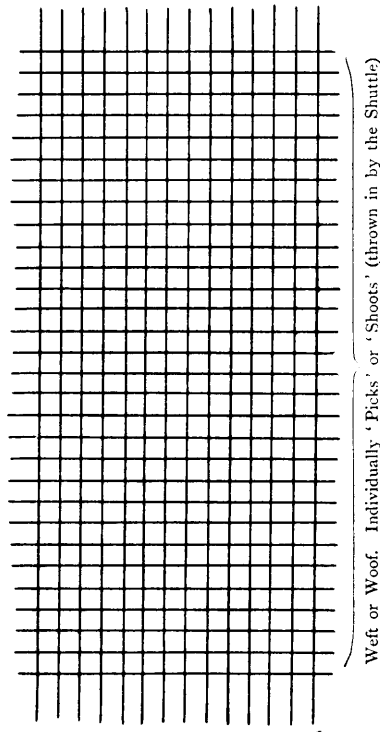

FIG. 3C.—DIAGRAM ILLUSTRATING IN FOUR STAGES THE CORRECT DRAWING OF THE PLAN OF A GAUZE STRUCTURE

usually intersecting at right angles. Note should now be made of the particular names of these two series. As indicated in Fig. 4, the vertical threads (which are placed

* Always draw guiding lines *thin*, so that they may be thickened as required.

in the loom, passing through the heald shafts) are termed collectively the 'warp' or 'chain'; individually they are spoken of as 'threads' or 'ends.'



Warp or Chain. Individually 'Threads' or 'Ends' (placed in the Loom)

FIG. 4.—ILLUSTRATING THE COMPOSITION OF AN ORDINARY WOVEN FABRIC

The horizontal threads (which are intersected with the vertical threads by means of the shuttle) are termed collectively the 'weft' or 'woof'; individually, 'picks' or 'shoots.'

The possibility of arranging various orders of interlacing of warp and weft will be apparent even to the novice. Thus the need for some method of indicating in a simple manner any required order of interlacing, and, further, of designing new orders of interlacing, will be very apparent. The method of drawing flat views and sections for any new

orders is far too cumbersome to be thought of for a moment.

Squared paper, or, as it is termed, 'point-paper,' or 'design-paper,' affords a convenient means of indicating any required interlacings and also of experimenting for

novel effects. True that in some cases it requires experience to see in the 'mind's eye' the effect produced in the cloth by any novel point-paper effect, but this applies equally to

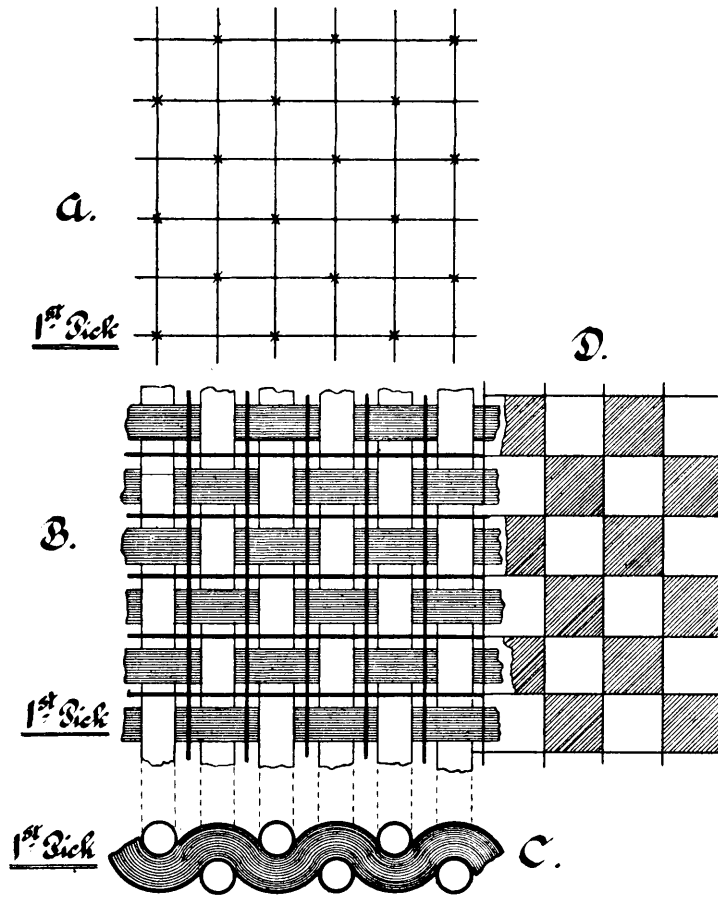

FIG. 5.—ILLUSTRATING THE REPRESENTATION OF PLAIN CLOTH ON POINT-PAPER

any system of designing, so that, all things considered, the ordinary point-paper method, helped out *occasionally* by plans and sections, cannot be improved upon. Fig. 5

clearly illustrates this method. The simplest method, and that most usually employed by those uninitiated in the art of textile design, is indicated in Fig. 5, A, in which the warp and weft are shown as lines, a cross being placed where the weft passes under the warp—*i.e.*, just at the intersection. Now this may be considered a fair method, and would do if there were not a better. There is a better method, however, which Fig. 5, B, C, D, illustrates. In the ordinary makes of cloths all spaces between threads and picks are closed up, a solid firm fabric being produced, so that Fig. 5, A, evidently does not in any sense represent the *appearance* of the cloth. On the other hand, Fig. 5, B and D, does give a fair idea of the surface appearance of the resultant texture, especially if warp is white and weft is black; hence the method indicated in Fig. 5, B and D, is now universally employed. In these figures the warp is supposed to be white (thus a blank sheet of design paper represents the warp in the loom), and the weft laying directly underneath the warp black. Now, a moment's thought will make it evident that the surface of the proposed cloth may be divided up into squares, each square representing a position where either warp *or* weft is on the surface; if warp the square will appear white, if weft the square will be black. Hence, in the following point-paper plans *marks will be taken to indicate weft coming over warp*, unless marks are specially stated to indicate warp. It will now be evident that a sheet of design-paper (say 96 × 96) must not be looked at as representing so many small squares, but in the first instance as so many vertical spaces representing the warp threads, while crossing these at right angles are a number of spaces

representing weft picks. At any given point of intersection warp or weft may be on the surface; if warp the square is left blank—*i.e.*, white—if weft the square is marked black. The thicker black lines (noticeable on

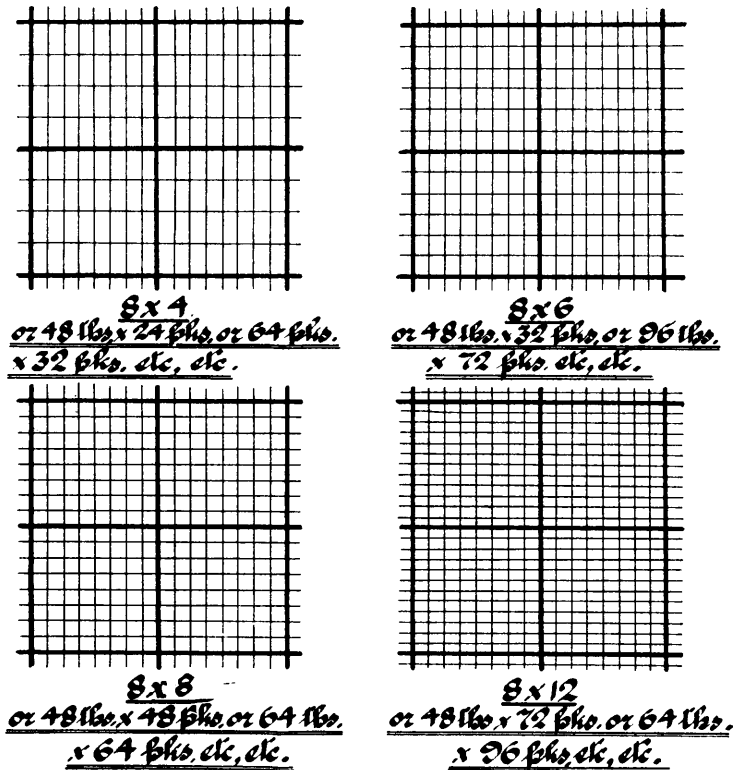

FIG. 6.—ILLUSTRATING VARIOUS STYLES OF POINT-PAPERS

ordinary point-paper) dividing the smaller squares up into eights are simply convenient guiding lines either for the designer or the card-cutter, as will be explained later.*

* It is a debatable point whether ten or twelve would not be a better number, but eight is fixed by trade practice, save in special cases.

If the student now examines a few ordinary cloths which happen to be at hand, he will soon find that, while the majority of cloths are built with an equal number of threads and picks in the same space (usually stated as

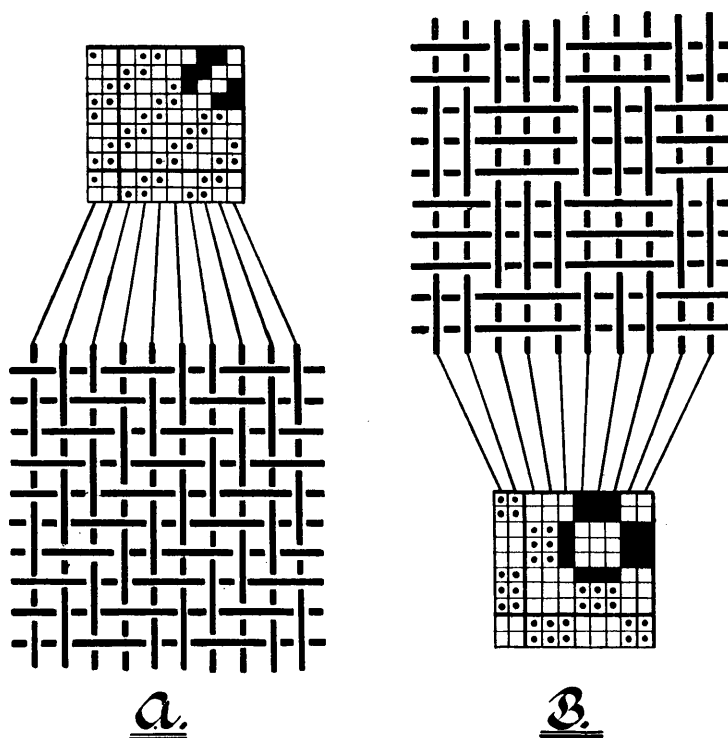

FIG. 7.—ILLUSTRATING THE RELATIONSHIPS OF FLAT VIEWS OR PLANS AND THE POINT-PAPER DESIGNS

so many *per inch*), yet many cloths are built with a different number of threads per inch to picks per inch. Whatever this number may be it must be represented by the design-paper. Thus, if the proportion is, say, 64 threads to 48 picks, the design-paper must be ruled in

this proportion—*i.e.*, with 8 thread spaces occupying the same space as 6 pick spaces, or, as it is termed, 8 by 6 design-paper (see Figs. 6 and 42, pp. 15 and 84). If this proportion is, say, 64 threads to 96 picks, the design-paper must be ruled in this proportion—*i.e.*, with 8 thread spaces occupying the same space as 12 pick spaces, or, as it is termed, 8 by 12 design-paper.

In Fig. 6 various styles of design-paper are shown, all of which are in constant use; the sizes 8 by 4, 8 by 6, and 8 by 8 are the ones most commonly employed, as cloths with threads and picks in these proportions are most usually required.

A few examples will probably clear up any difficulties respecting the use of point-paper. In Fig. 7 (A) the ordinary $\frac{2}{2}$ twill structure is transferred from the point-paper to the flat view, and in Fig. 7 (B) the $\frac{3}{3}$ mat flat view is transferred on to point-paper.

In Fig. 8* A is a fancy twill effect on point-paper, B is the flat view of the same, and A¹ is a reconstruction on point-paper from the flat view B, the threads being placed in a different order to that which they occupied in A; hence a new weave—‘the twilled mat’—is produced.

From these few examples the student will probably be able to draw flat views from given point-paper effects, or *vice versa*. A series of standard weave effects is given on Design Sheet 1 (p. 22), any of which may be treated as indicated in the foregoing.

* Whether warp and weft are actually white or coloured; black on point-paper represents *weft coming over warp*.

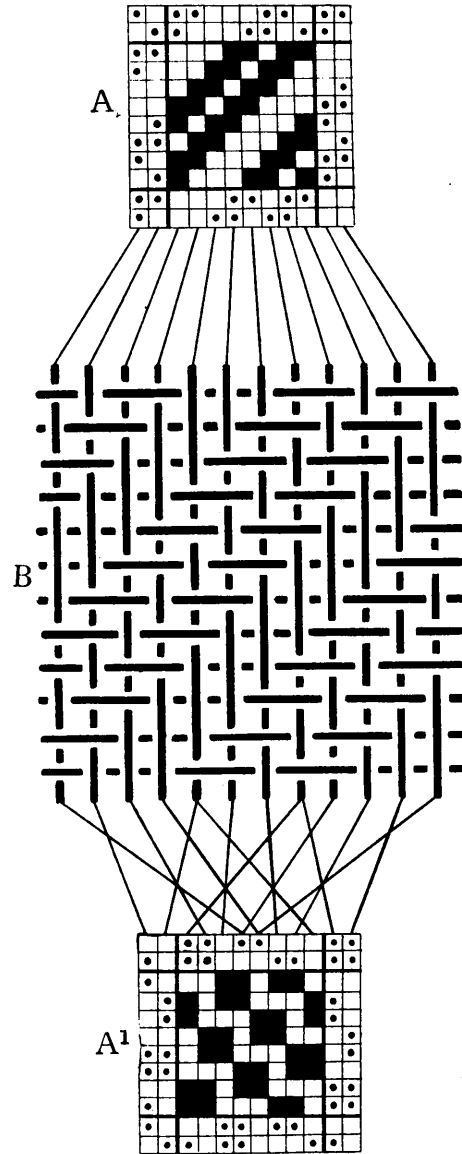

FIG. 3.—ILLUSTRATING THE REARRANGEMENT OF A TWILL; ALSO THE RELATIONSHIP OF PLAN OR FLAT VIEW OF FABRIC TO POINT-PAPER PLAN

CHAPTER II

THE PREPARATION OF THE WARP FOR THE LOOM AND THE ELEMENTS OF WEAVING

IF the student has carefully read the preceding chapter, and worked some exercises, he will have attained to a fair knowledge of the construction of the simpler fabrics. The question now naturally arises, How may such interlacings (Figs. 7 and 8, for example) be produced in quantity?

It is probable that in the remote past our ancestors made fabrics out of the crude thread structures they were able to produce by an equally crude method of interlacing, but it is well to realize that to-day *perfect* structures are produced in *quantity* by mechanical means. It is these mechanical means which must now be carefully considered, but before proceeding to this study the student must be impressed with the importance of *accurate work and careful forethought*. If a hand-loom weaver makes a mistake, his error affects only his own particular loom; but if the manager of a large factory makes a mistake, it may affect hundreds of his fellow-workers.

THE REPETITION OF DESIGN OR FIGURE

It is evident that in order to make a piece of cloth of any size (say, according to the interlacing shown in Fig. 1)

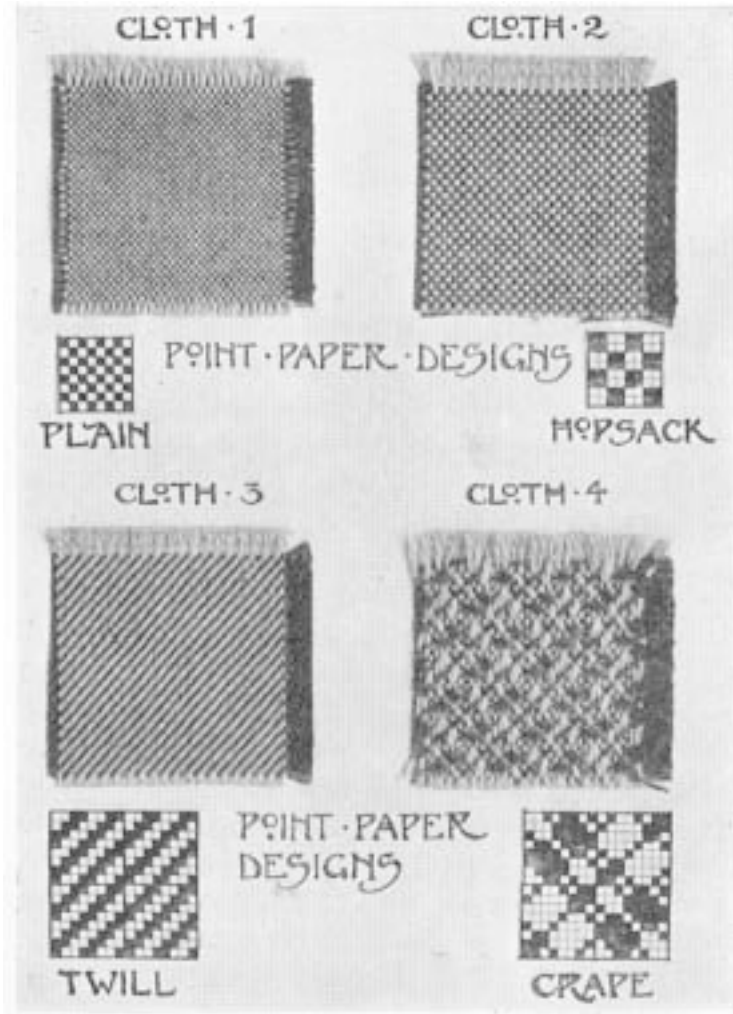

PLATE 1.—STANDARD WEAVES

more than one repeat of the weave must be given ; in fact, in this particular case, to produce a piece of cloth say, 30 inches wide, about 900 repeats of the weave would be necessary, for in an ordinary fabric there will be, say, 60 threads per inch, and—

60 threads per inch \times 30 inches wide = 1,800 ends
across the piece ;

and—

1,800 ends in warp \div 2 threads in the repeat = 900
repeats of the weave (Fig. 1) across the piece.

If the weave shown in Fig. 8 is employed, the number of repeats will be as follows :

1,800 ends in warp \div 8 ends in the repeat = 225 re-
peats of the weave across the piece.

The same remarks apply to figured effects, for, as shown in Fig. 9, if an ordinary size of figure (say, 4 inches) is required on a cloth 32 inches wide, this figure must be repeated eight times.

What must now be considered is, How does a loom effect the required interlacing and at the same time repeat the pattern as often as required to make the cloth of the desired width ?

THE ' HEALDS ' OR ' HEDDLES '

The method of effecting the interlacing of a set of threads is illustrated in Figs. 10 and 11. In Fig. 10 the dividing of the threads into two sets to produce the interlacing shown in Fig. 1 is illustrated, the two heald-shafts employed working exactly opposite to one another for consecutive picks. In Fig. 11 the threads are divided into four sets, each set working in a different manner—



FIG. 9.—ILLUSTRATING HOW THE 'UNIT OF REPEAT' IS REPEATED ACROSS THE PIECE BY A JACQUARD LOOM

i.e., being over and under different picks of weft. In order that each set of threads may be conveniently worked, they are passed through the mails, these usually consisting of pieces of metal stamped with three holes, as shown in Fig. 12, the larger, A, being for the thread to pass through and the smaller, B, B, for the cords or 'heald-bands,' which in turn wrap round two shafts—one below and the other above the mails—so that the set of threads passing through the mails on this 'heald-shaft' towards the cloth may be lifted or depressed as desired.

The wood shafts must be sufficiently strong to lift the warp which they have to work, not too thick—or they rub against each other and break down the heald-bands—and conveniently longer than the full width of the healds. On examining carefully Fig. 11, the method of lifting the heald-shafts for producing the interlacing indicated will be fully realized, two heald-shafts being always up, and as each stays up for two picks the change

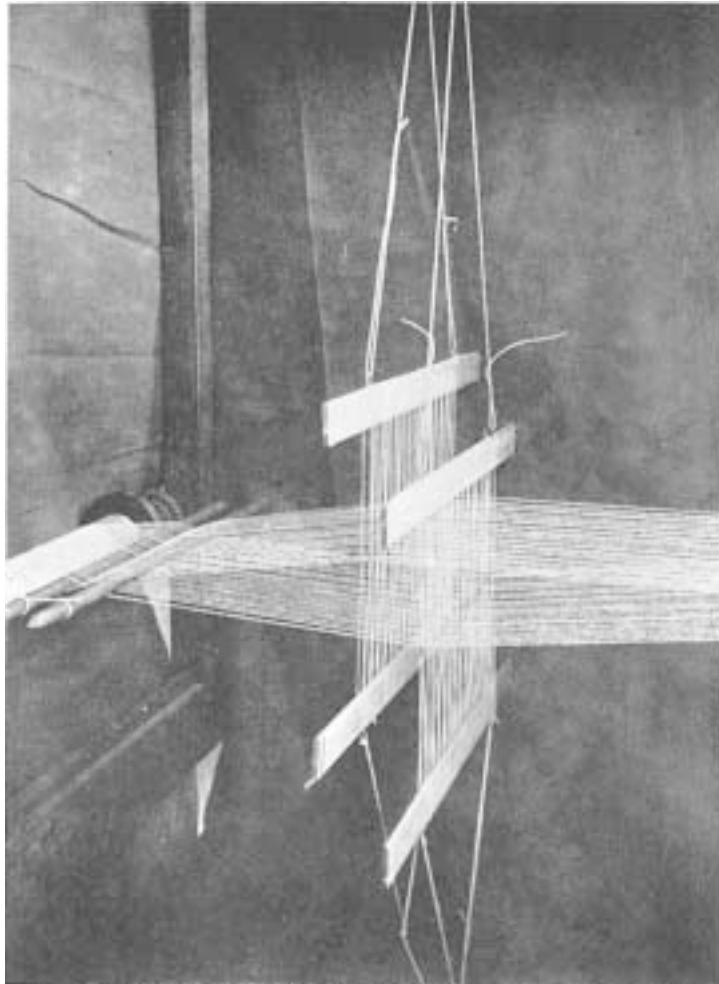
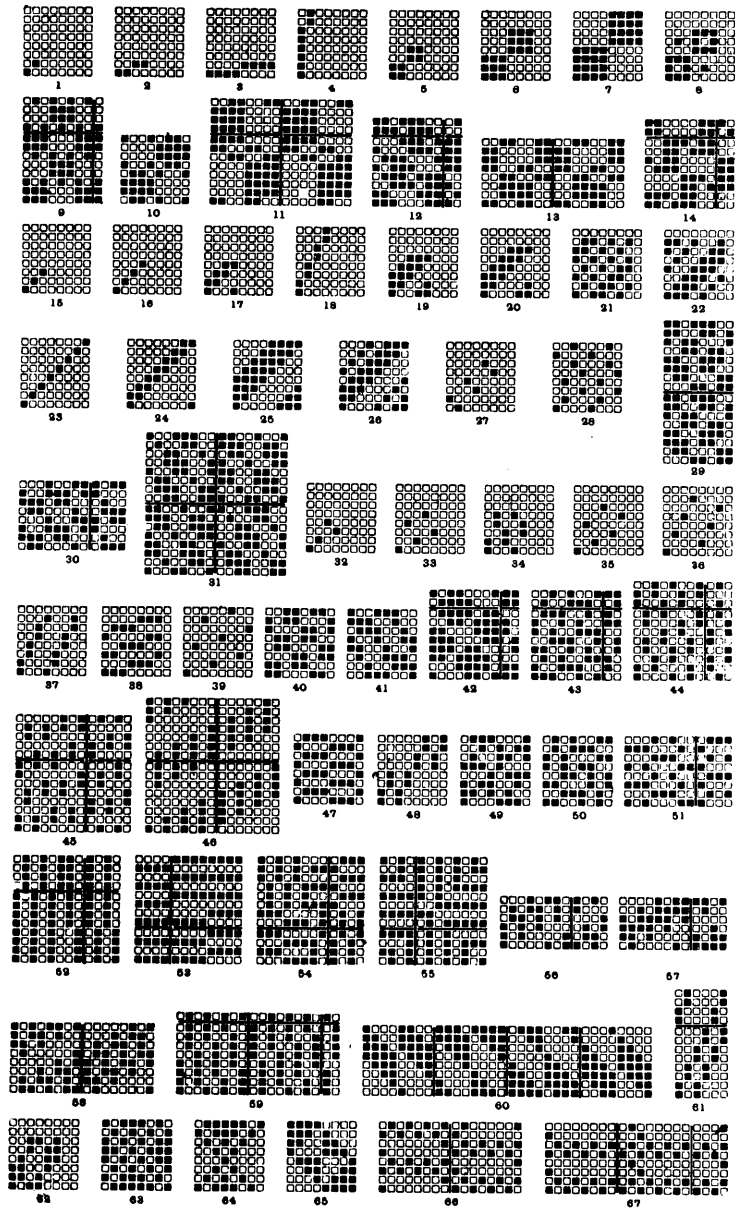

FIG. 10.—ILLUSTRATING THE ACTION OF HEALD-SHAFTS IN FORMING A 'SHED'
FOR THE PASSAGE OF THE SHUTTLE

PREPARATION OF THE WARP



DESIGN SHEET I.—STANDARD WEAVES

between each pick will be one depressed to one elevated, thus forming a different 'shed' or opening for each pick. For example :

For the 1st pick, shafts 1 and 2 are depressed, and 3 and 4 elevated
 „ 2nd „ 2 and 3 „ „ 4 and 1 „
 „ 3rd „ 3 and 4 „ „ 1 and 3 „
 „ 4th „ 4 and 1 „ „ 2 and 3 „

The means of obtaining the repetition of the weave effect will now be clearly realized, *for each heald-shaft will work the threads drawn onto it in the same manner*, and as in Fig. 11 there are four heald-shafts, therefore every fifth thread will be a repetition of the first, the sixth of the second, and so on. To obtain the number of repeats across the piece, divide the number of threads in the warp by the number of the shafts; thus 1,800 threads in the warp ÷ 4 heald-shafts = 450 repeats of the pattern, or 450 threads—and, consequently, mails—on each heald-shaft. It will thus be evident that heald-shafts must be ordered to suit each particular cloth, unless such are always in stock or can be made up from old sets. The usual method of doing this is as follows :

HEALD ORDER SHEET.

No. of healds required (Say, 4).
 Width of healds... .. (Say, 30 inches). Length of shafts
 (say, 36 inches).
 Depth of healds (Say, 14 inches—*i.e.*, 7 inches at top
 and 7 inches at bottom).
 No. of healds per inch (Say, 60, giving 1,800 in 30 inches).
 *Size of string, quality (Say, No. 6 glazed cotton).
 *Size of mail (Say, No. 4A).

* Cords of standard sizes, as kept by the heald-makers, should always be ready to hand (see Figs. 13 and 13A).

Such a form as the foregoing should be printed and always employed when ordering healds, so that exact and complete particulars are always given; there is then no question of forgetting anything. The depth of the healds must be decided according to the number of healds to be employed together, for if, say, twenty are to be used, the heald farthest from the cloth in the loom must be lifted higher and depressed lower than the front heald

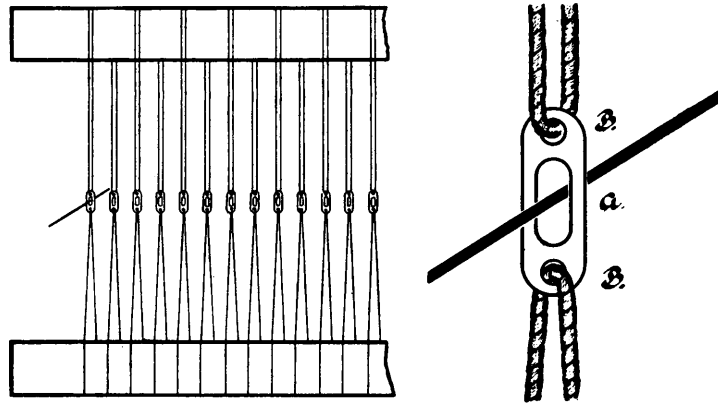

FIG. 12.—ILLUSTRATING THE CONSTRUCTION OF GEARS
Note specially the top and bottom 'leasing'

(as will be explained later); *and there must be a sufficient distance between the mail and the shaft to allow the threads passing between the cords on it (not through the mails on it) to work freely—i.e., depth of wood-shaft+depth of deepest shed+clearance desired.* Hence it is customary to make the healds for four shafts about 12 inches deep, while the healds for, say, thirty-two shafts are made up to 18 inches deep.

The size of the cord is usually decided by the number

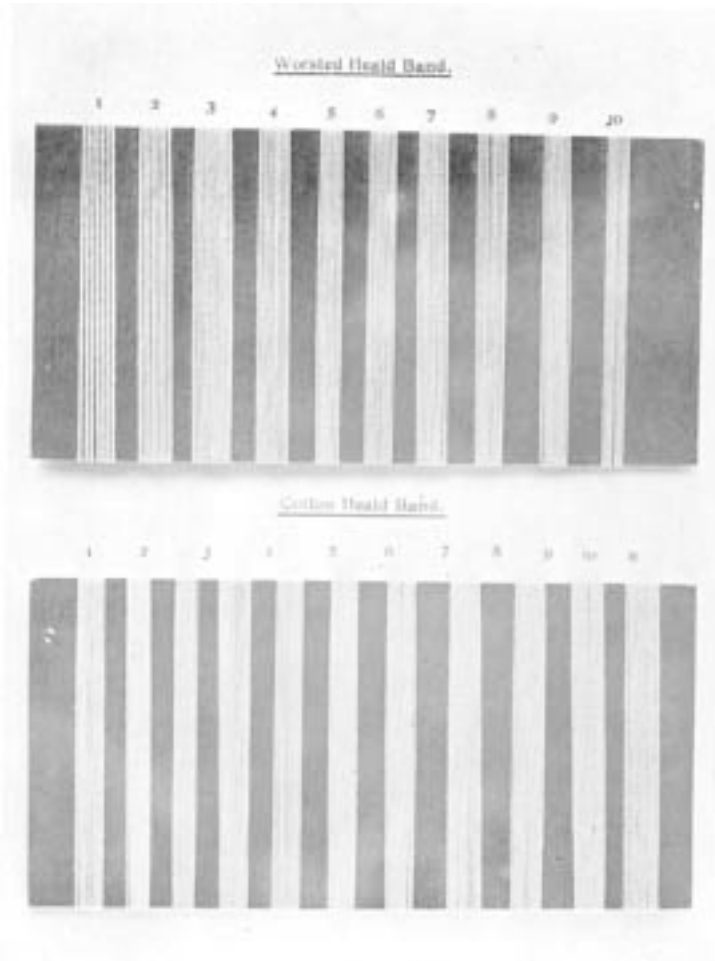

FIG. 13.—ILLUSTRATING THE ORGANIZATION OF DETAILS (HEAD-BANDS)

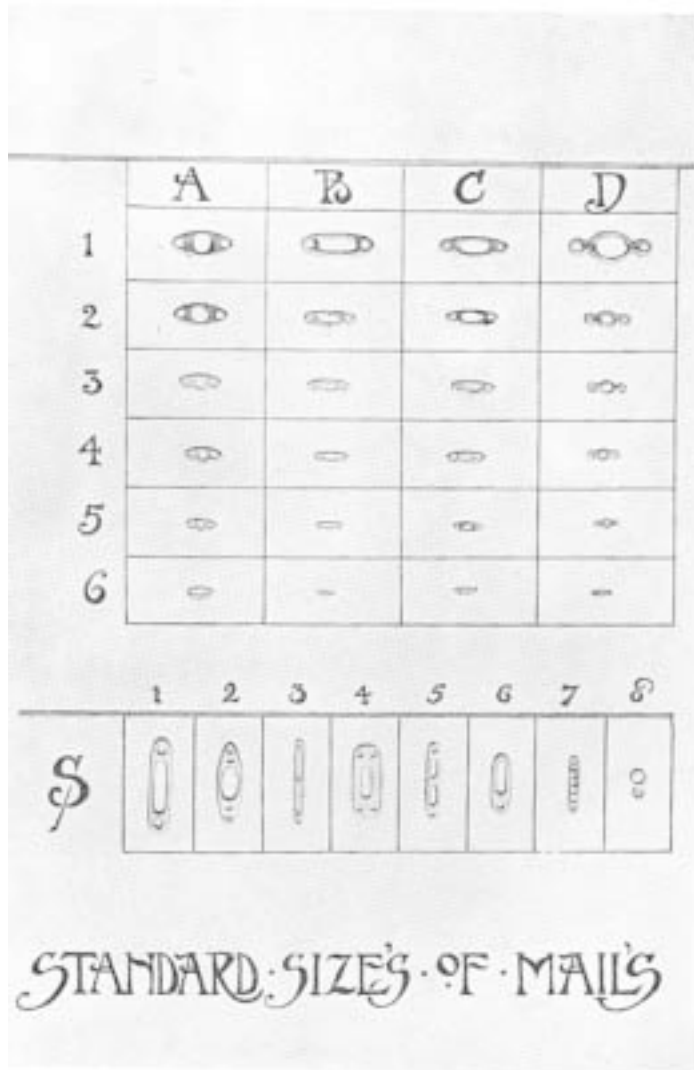

FIG. 13A.—ILLUSTRATING THE ORGANIZATION OF DETAILS (MAILS)

of mails per inch, the more mails per inch and the finer the cord, otherwise the forest of cord through which the warp passed would most certainly damage it.*

The size of the mail must be selected according to the yarn to be woven; the size should be such that a double knot tied on the yarn will pass freely through. In Fig. 13A several varieties of mails are given, arranged as each manufacturer should arrange his mails—*i.e.*, in a convenient form to order from.

THE 'SHUTTLE' AND THE 'REED'

Having thoroughly thought out the action of the heald-shafts—how they prepare a passage for the successive picks thrown in by the shuttle—the method of inserting the weft and of satisfactorily laying the picks or weft threads side by side to form a firm texture must now be considered. The shuttle is simply a case to hold the weft yarn so that it can be passed between the divisions of the warp—termed the 'shed'—cleanly and without damage either to itself or the warp.

In the crudest form of hand-loom—such as that still used by various savage or semi-barbaric tribes—the shuttle is usually thrown through the shed—*i.e.*, between the two sets of warp threads—by hand, and the weft thread or 'pick,' which is left in the shed, is beaten up to the one previously inserted by a comb. This will answer fairly well for narrow cloths, but for broad cloths some mechanical method of throwing the shuttle and of guiding it safely from one edge of the cloth to the other is evidently desirable.

* For a similar reason it is sometimes desirable to use four shafts instead of two shafts in weaving plain cloth (Fig. 1).

Such a device was introduced by Kay in the year 1733, the shuttle being thrown from its resting-place (called the shuttle-box) at one side of the loom to a resting-place at the other side of the loom by means of a kind of 'sling' consisting of a convenient handle attached to a cord, which in turn, by another cord, is attached to the 'picker' or part which comes in contact with the shuttle, and throws it across the piece (through the shed formed by the healds) to the 'picker' at the opposite side, which is usually drawn forward to meet the coming shuttle, bringing it slowly to rest (termed 'checking' the shuttle), and then in its turn throwing the shuttle back again through the succeeding shed formed by the healds changing positions (see Figs. 14 and 14A).

Now, it will be evident that there must be something to guide the shuttle as it passes through the shed formed by the healds, or it might pass downwards or get entangled in the healds; this control is effected by the 'shuttle-race' and the 'reed.' The reed takes the place of the comb previously mentioned, and is firmly swung in a framework so that it can be brought into contact with the cloth or pushed back towards the healds just as required. The reed fulfils a threefold purpose: (1) It distributes the threads evenly across the width of the piece, making a 'level' cloth; (2) it serves as a guide, keeping the shuttle in its right course horizontally; (3) it serves to beat up the pick just inserted to those already inserted, thus making a firm texture. In Fig. 15 the construction of a reed is clearly shown; it varies from a comb in being double-headed (*i.e.*, not open at one end), and, consequently, stronger.

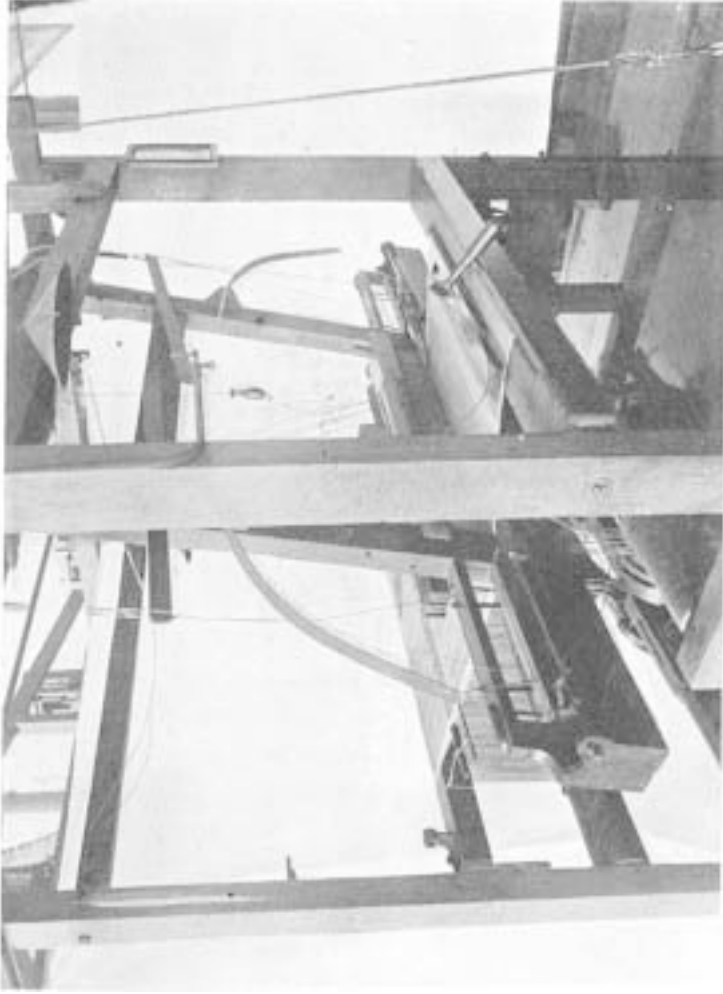

FIG. 14. — ILLUSTRATING THE HAND LOOM AND BAND LOOM WEAVING

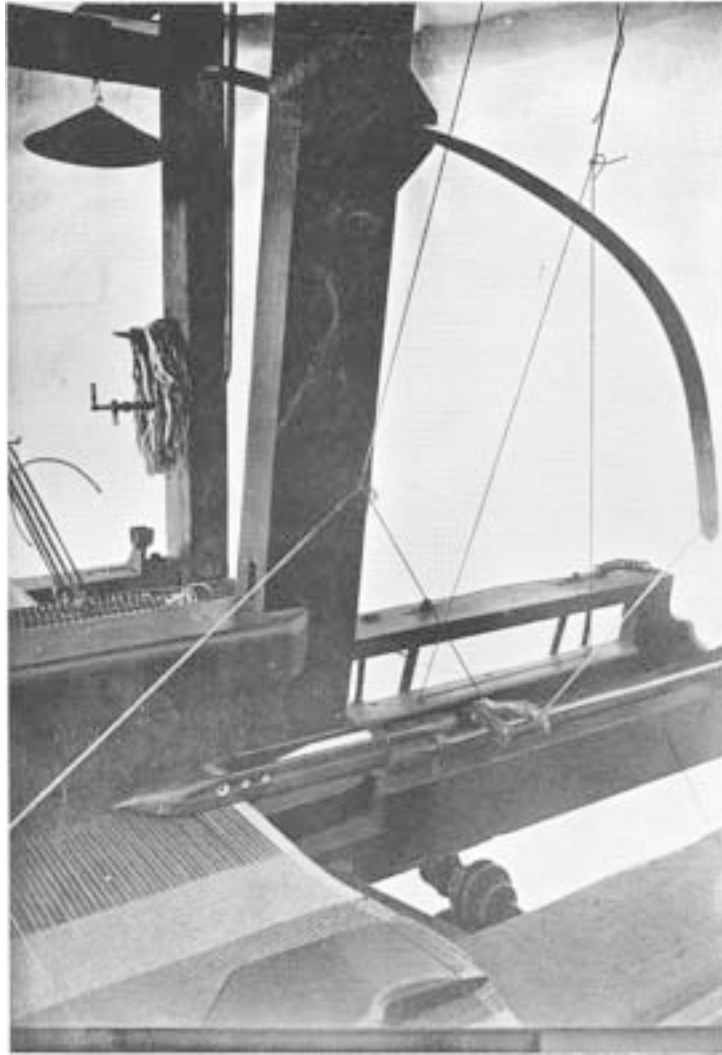

FIG. 14A.—ILLUSTRATING HAND LOOM WEAVING

With every set of healds, then, a reed must be ordered ; the number of threads per split suited to the material in hand can only be decided by experience, running from one for the best lustre goods up to six and eight for close, thick worsted coating and woollen warps. The depth must be such that a shed of sufficient size for the shuttle to pass through may be formed, and the length as long as the loom will carry—*i.e.*, reaching from box to box of the loom. Like the healds, a regular order form must be kept as follows :

REED ORDER SHEET.

No. of reeds required	(Say, 6).
Set	(Say, 12 dents per inch).
Depth	(Say, 3½ inches).
Width	(Say, 48 inches).

As a rule, the reed-maker will use the wire suited to the particular set required. The shallower the reed and the stronger ; thus a reed with 60 splits per inch would be made as shallow as the shuttle will allow (say, 3 inches).

The 'shuttle-race' referred to is simply the length of smooth firm wood which forms an L with the reed, as shown in Fig. 14, for the shuttle to run in. Thus, what is termed the 'going-part' of a loom consists of the framework in which the reed is suitably swung, the reed, an addition to the framework termed the 'shuttle-race,' and the shuttle-boxes or 'clearance' at each end for the shuttle or shuttles to rest in while the reed is beating up each pick.

PREPARING THE WARP

Attention must now be directed to the preparation of the warp for the loom. Up to this point it has been taken for granted that the warp is on the beam, has been

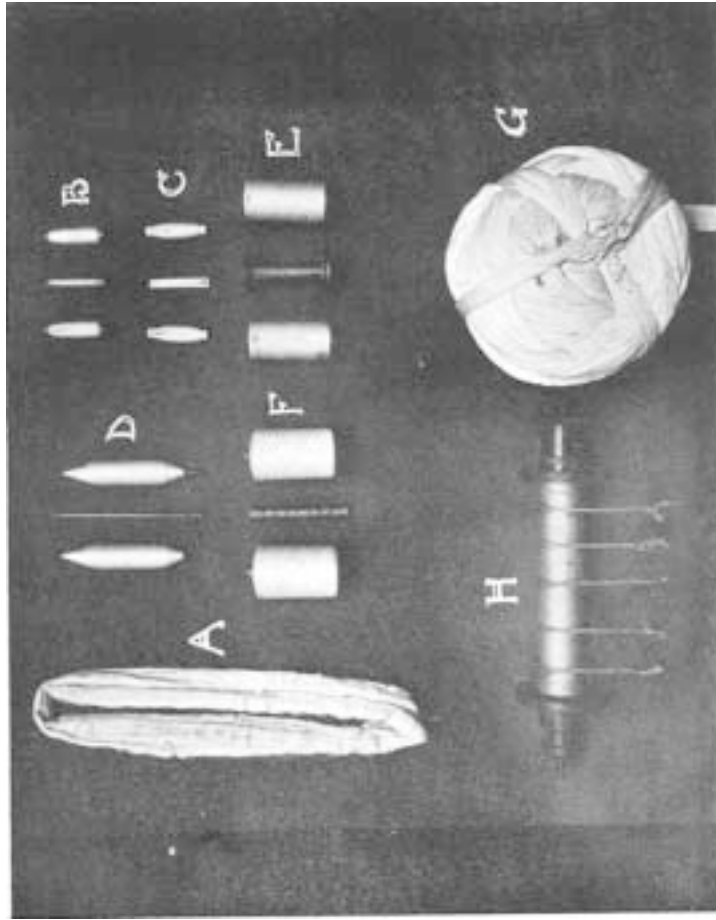

FIG. 16. — ILLUSTRATING THE VARIOUS FORMS UNDER WHICH YARNS ARE PLACED ON THE MARKET

passed through the healds and the reed, and is in a fit state to weave with ; but how has it been got into this state ?

Yarns are delivered to the manufacturer in eight forms—viz., in the hank (A), on spools (B)*, tubes (C), cops (D), double-headed bobbins (E), cheeses (F), warp in ball form (G), and warp on the warp beam (H), as illustrated in Fig. 16. In whatever condition it is received (and it should be ordered in the most convenient form) it is necessary, if for warp, to get it into the state shown in H—*i.e.*, on to the loom-beam. This beam is made a convenient length to fit the loom for which it is intended, and in beaming the warp on to it three points must be kept in view—viz., first, to get the given warp approximately the width of the resultant cloth required (preferably slightly wider); second, to distribute evenly the required number of threads the required width, in order that a level cloth may be formed;† third, to place an absolutely equal tension on each warp-thread and to compress on to the beam, as it is slowly revolved, the required length of warp (say, 70 yards to make 64 yards of cloth, as will be considered later).

Before briefly considering each of the foregoing, attention may be directed to another important matter, often of great importance—viz., the order in which the threads are wound on to the beam, and, consequently, the order in which they are drawn through the healds and passed through the reed to effect the desired arrangement

* The question of 'tare'—*i.e.*, the material *not* yarn—in this case comes in and causes much trouble.

† There must be the requisite number of warp-threads, of mails, and of splits in the reed in the given width.

in the resultant cloth. Take a simple example : suppose a warp is required coloured as follows :

COLOUR PATTERN.

7	threads	dark
2	„	mid
7	„	dark
7	„	mid
2	„	light
7	„	mid
<hr/>		

32 threads in repeat of colour pattern.

The cloth is to be 36 inches wide, with 64 threads per inch (*i.e.*, two repeats of the colour pattern per inch). It will obviously not do to beam the warp on to the loom-beam in any order ; rather must perfect order prevail at the outset and be maintained throughout. This is effected by warping to pattern, and to effect this—the right quantities of yarn having been ordered—cheeses or cops of each colour must be placed in a suitable creel (*i.e.*, a frame for conveniently holding bobbins or cheeses and taking a lease) in the above order, and from these cheeses or cops a sufficient length is drawn and a sufficient number of repeats of the pattern are laid side by side to make the cloth the required width ; in the above case seventy-two patterns would be made, giving altogether 2,304 threads in the warp evenly distributed within 36 inches.

The warping may be accomplished in three ways—*viz.*, on the bartrees (by hand), on the cheese system, and on the Scotch or the Bradford warping mill.

HAND WARPING ON THE BARTREES

On whatever system the warp is to be made the first necessity is to suitably hold the yarn, in whatever form it may be, so that it can be drawn off as required at an even tension. A given order of colouring may also be required, along with a convenient arrangement for obtaining an end-and-end lease (see Fig. 17) to retain such order when once attained.

Creels for effecting this are usually made in four forms—viz., horizontal, flat vertical (Fig. 17), V-shaped vertical (Fig. 21), and semicircular vertical (Fig. 18). The horizontal creel is employed for cops and spools, in which the yarn is drawn from the apex, and the three other forms for cheeses,* bobbins, etc., which revolve on their own axes.

The preliminary step in commencing to warp on the bartrees consists in drawing the threads through the guides on the creel in the required order and then by hand or by a special 'lease-reed' forming the end-and-end lease. This is transferred to the 'bartrees,' as shown in Fig. 17, and then the whole series of threads is wrapped backwards and forwards and downwards, according to the length required. At the bottom the 'foot lease' is formed by wrapping the whole series of threads (say, 32) over the lease-pins in one way and back in the opposite way, as shown, and then up to the end-and-end lease again, the operation being repeated by a skilful twisting of the series without break until, say, 2,304 ends

* There is a patent attachment by which the yarn may be drawn from either end of a bobbin or cheeses at an even tension without the cheese or bobbin revolving.

are obtained—*i.e.*, thirty-six times down and up the bartrees. If required, say, 72 yards long, and the bartrees are 6 feet across, then the warp will be carried eighteen times backwards and forwards from side to side, the slight surplus in length, due to the diagonal direction in which the warp is carried, being allowance for twisting in, etc.

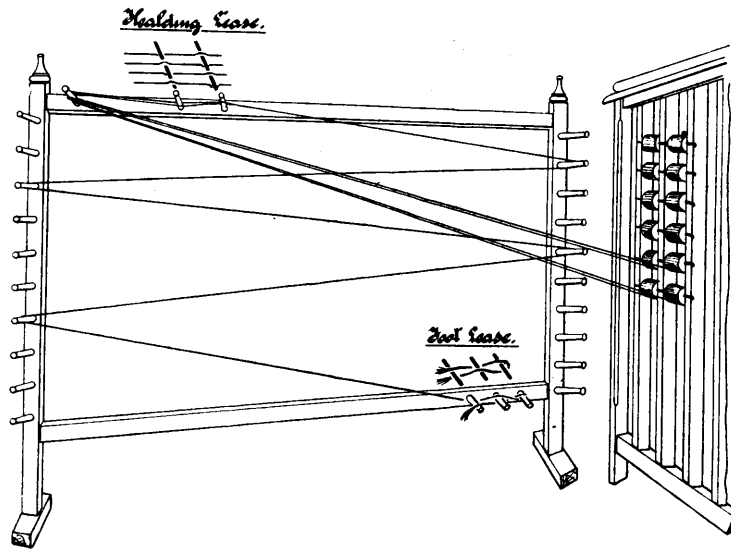

FIG. 17.—ILLUSTRATING THE PRINCIPLES OF WARPING

Thus the making of a warp is accomplished—*i.e.*, a given number of threads of a required length arranged in a required order.

In the woollen trade warps are dressed on to the loom beam through the foot lease, but in the worsted and other textile trades every thread is separated, the end-and-end lease being run from beginning to end of the warp as it is slowly and regularly wound on to the beam, as shown in Figs. 21A and 21B.

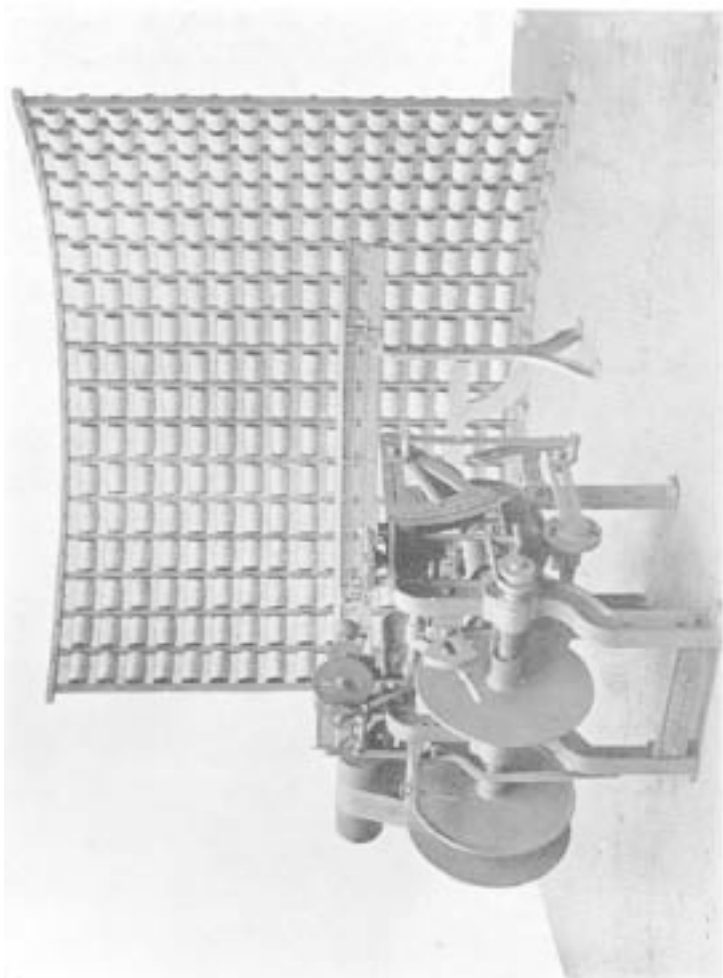

FIG. 18.—CHEESE WARPING BY POWER

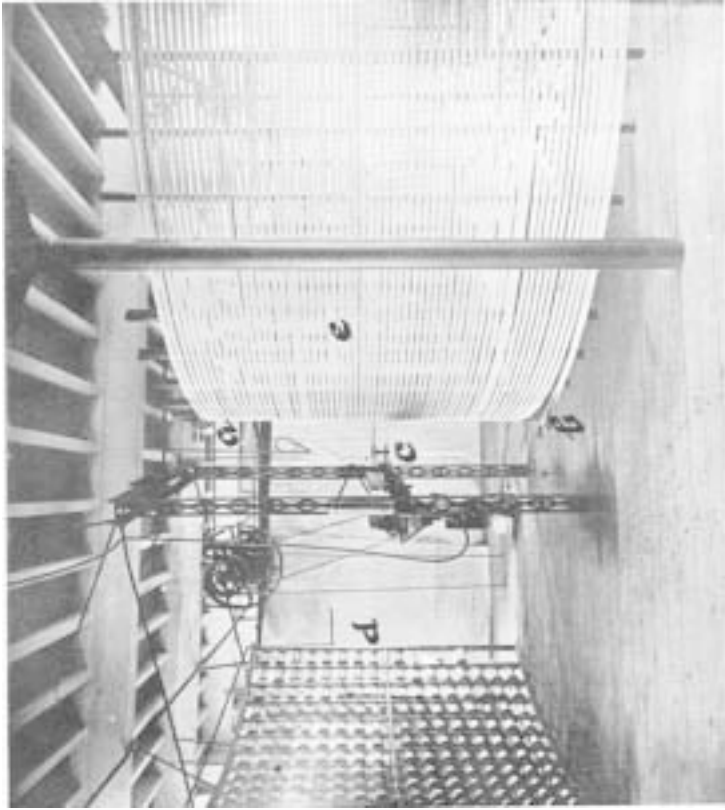

FIG. 19.—WARPING ON THE 'BRADFORD MILL,' BY POWER



FIG. 20.—WARPING ON THE 'SCOTCH MILL' BY POWER

WARPING BY POWER

Warping by hand, save in the case of pattern warps, where colourings are complex and changes frequent, has now been superseded by machines designed to work quicker, and, generally speaking, better in every way. In these machines the warp is built up in sections, say, of 4 inches each, these being combined to produce the requisite width of warp—*e.g.*, for a 32-inch warp, $32 \div 4 = 8$ sections. The capacity of the creel is here the limit, for in this example with 60 threads per inch, $60 \times 4 = 240$ bobbins in the creel, and if the creel is twofold, so that as one half is being filled the other is emptied, a capacity of 480 is required. These sections are conveniently held on either cheeses (Fig. 18) or a 'balloon' (Figs. 19 and 20), and then wound on to the warp-beam at a uniform tension. The ordinary cheese system is illustrated in Fig. 18 with a semicircular creel. This type of machine is also made as a combined warping, sizing, and drying machine.

The Bradford warping mill is illustrated in Fig. 19, in which the sections are laid side by side *diagonally* on the vertical balloon from top to bottom. The Scotch warping mill is illustrated in Fig. 20, in which the sections are built up *side by side* on the horizontal balloon, not diagonally, as in the case of the Bradford mill.

Whichever arrangement is adopted, means must be taken to insure uniform tension of the threads, a perfectly defined order, the exact length required, and, finally, the required number of threads in the necessary width. All machines should be fitted with a reversing motion to 'piecen-up' (*i.e.*, to tie up) the broken threads.

To insure uniform tension on the threads it is now customary for manufacturers to order their spinners to wind a given number of yards on to each cheese, so that they may all run off together at a similar leverage, at the same time avoiding waste bits.

There is also a system of warping known as the 'Warper's Beam System,' in which, say, four beams are employed, the 500 threads from the creel run on to each, and then the four combined thus : $500 \times 4 = 2,000$ ends in the warp. This is illustrated in Fig. 21, one beam here being built up which subsequently will be run with several more. This method obviously distributes any stripiness much better than does the Scotch warping mill.

WARP SIZING

If warps are strong enough to weave without sizing—*i.e.*, without the fibres glueing down and strengthening—so much the better, for any size applied must be taken off sooner or later in the dyeing and finishing operations which are to follow. Many warps, however, will not weave without sizing more or less strongly, or, to put it in another way, they weave so much better after sizing that the additional expense of sizing (say $\frac{1}{4}$ d. per pound) is amply compensated for. The operation of sizing simply consists of saturating the warp-threads—in a state of regularity and tension—with a solution of either animal (for animal fibres) or vegetable (for vegetable fibres) size, and drying them in this state by means of heat or an air blast.

DRESSING AND BEAMING

If the warp is received by the manufacturer in the warp state—having been already made on one or other of the

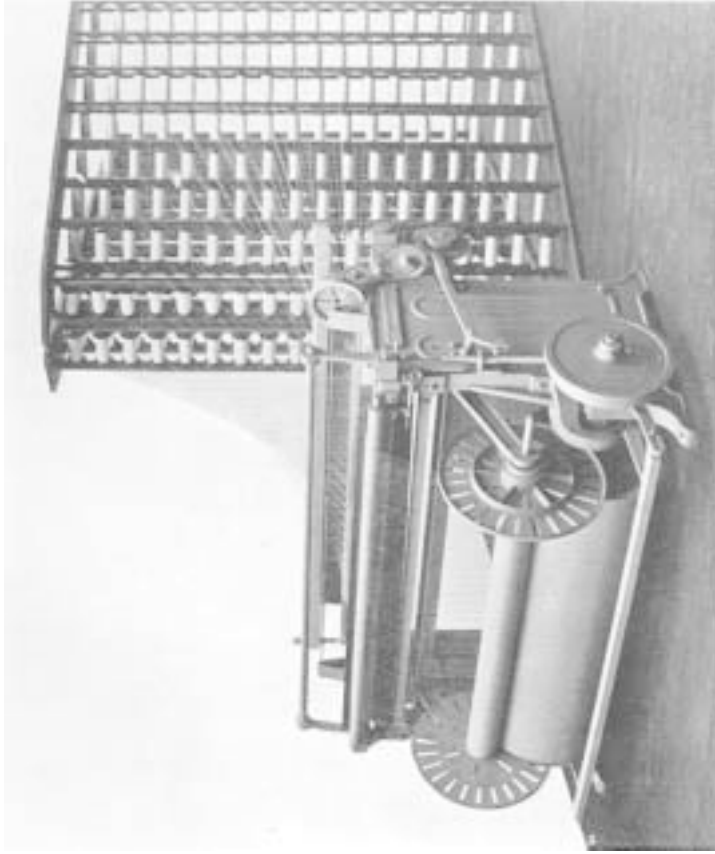

FIG. 21.—THE 'WARPERS' BEAM' SYSTEM OF WARPING BY POWER

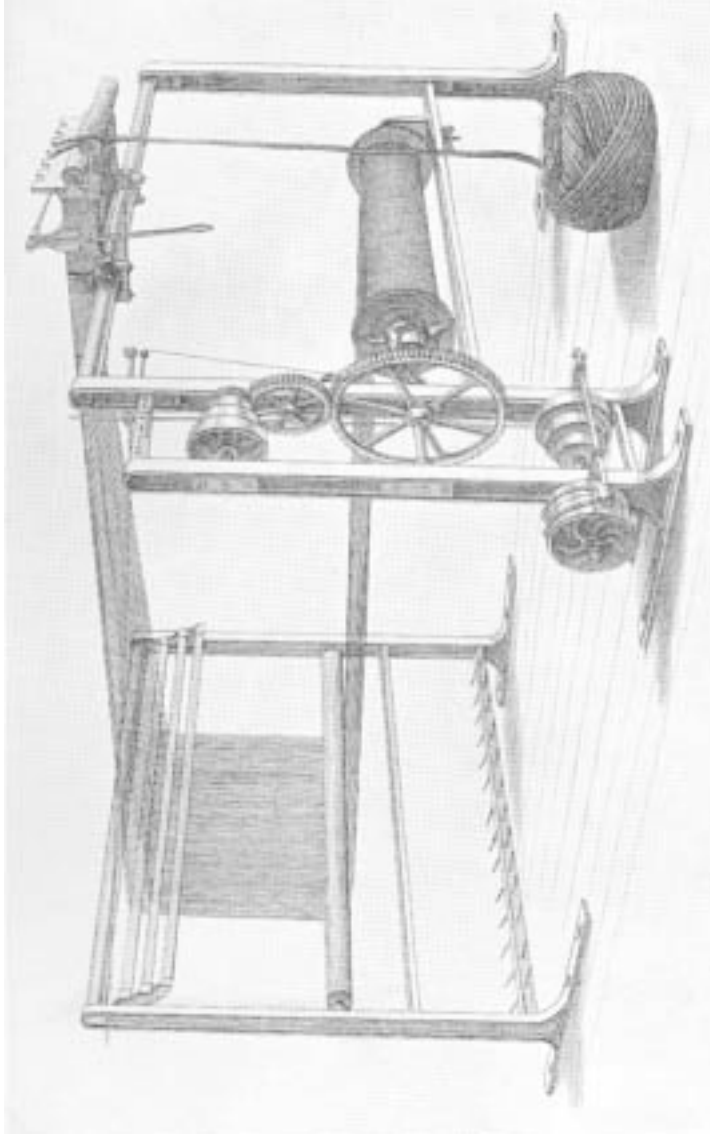

FIG. 21A.—IMPROVED WARP DRESSING AND BEAMING MACHINE (MADE BY D. SOWDEN AND SONS, SUDBURY)

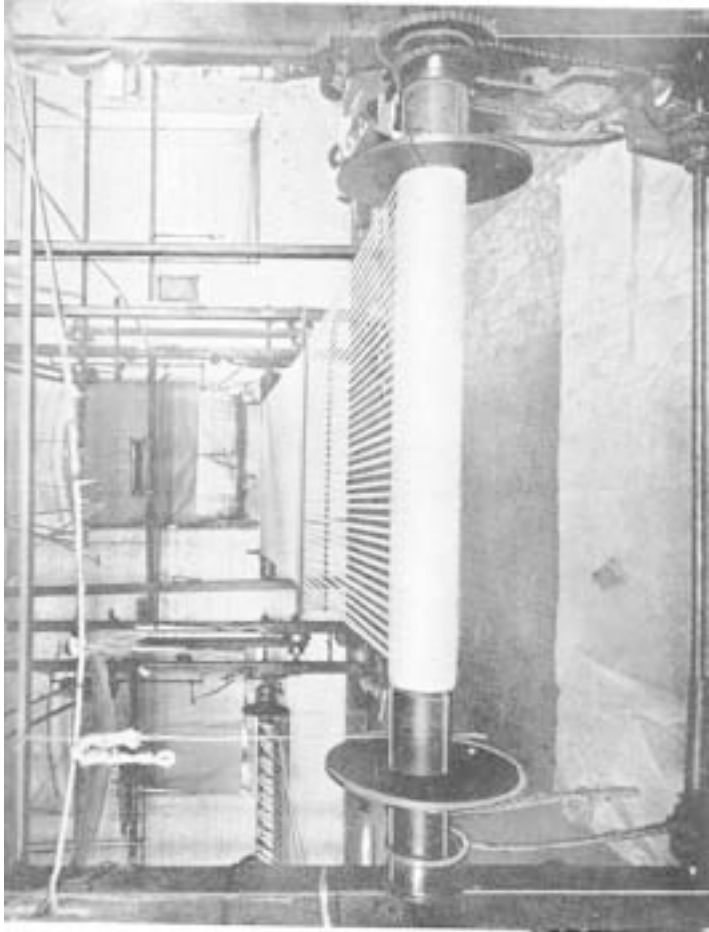

FIG. 21B.—ILLUSTRATING DRESSING FROM THE 'END AND END' LEASE AFTER DRESSING FROM THE 'FOOT' LEASE

systems noted—all that remains to be done is to sley the warp, say, two in a reed, attach it firmly to the warp-beam and run first the sley and then the end-and-end lease—which is always left in—from end to end of the warp as it is slowly wound on to the beam. The necessary friction to compress the warp on to the beam is obtained by passing the warp over and under the pins or tension rods, provided at A, Fig. 21A, according to the tension required. Fig. 21B shows the second dressing of a warp, it having been ‘raddled’ or dressed from the foot lease first, and then dressed by the end-and-end lease to obtain absolutely perfect distribution. A recent American invention consists in applying a compressor directly on to the warp-beam, thus enabling 20 per cent. more length to be got on for a given diameter.

Having beamed the warp satisfactorily on to the loom-beam, the question now naturally arises, How are the warp-threads drawn through the mails in the right order and finally passed through the reed? These operations are respectively termed ‘drawing-in’ and ‘sleying.’

DRAWING-IN AND SLEYING

To effect this the first move is to suitably fix up the beam with the warp on, so that the threads hang conveniently; also the healds through which the warp has to be drawn, so that a heald on any required shaft may be quickly selected and the right thread drawn through it. This is illustrated in Fig. 22, from which it will be evident that a ‘reacher-in,’ sitting at A, will be able to select the threads according to pattern, and the ‘drawer-

in,' sitting at B, may readily select a mail on the required shaft—by means of the additional shafts marked C, and placed alternately or in the most convenient order—push his reed-hook (Fig. 23) through this mail, the reacher-in hooks on the required thread, the hook is withdrawn rapidly through this mail, and thus the thread drawn upon the heald as required. The arrangement of the number of shafts, of the order of draft, etc., will be best understood by reference to Chapter VII.

'Sleying' follows, being effected by suitably fixing the reed just under the mails of the healds into which the warp has just been drawn, and then dragging the threads in groups of two, three, four, etc., as already explained, through the requisite split or space in the reed. This will be understood by reference to Fig. 24.

The weaving overlooker now takes the warp in charge, puts the beam into position, hangs the healds in the necessary position, attaches the new warp protruding through the reed to the old warp already in the loom (or a substitute), and then the operation of weaving follows.

If an old set of healds is to be again employed, instead of clearing out the old warp-end or 'thrum,' as it is called, the 'twister-in' places the new warp conveniently in the loom and twists or ties the new warp to the old. When this is completed he slowly draws the old warp through the healds and reed, which in turn draws the new warp after it, and thus a great saving in time is effected in both drawing-in and sleying (see Fig. 25). Under any circumstances, however, not only must there be absolute coincidence between the warp on the beam, the healds, and the reed, but each thread must be drawn through a



FIG. 22.—'DRAWING-IN' THE WARP

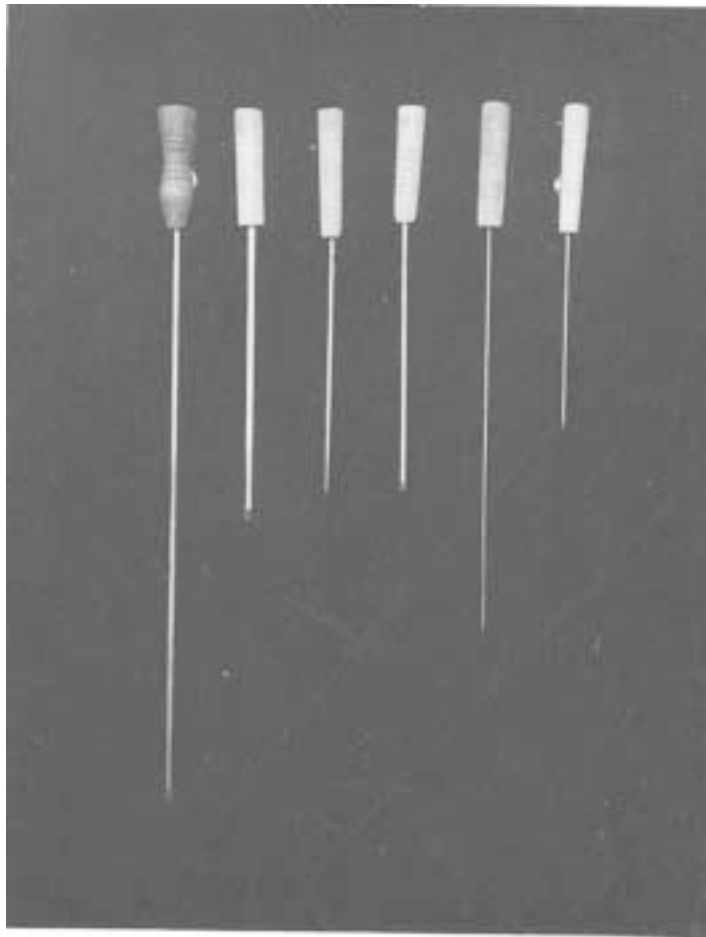

FIG. 23.—ILLUSTRATING THE ORGANIZATION OF DETAILS (HEALD-HOOKS)



FIG. 24.—'REEDING' OR 'SLEYING' THE WARP AFTER DRAWING-IN

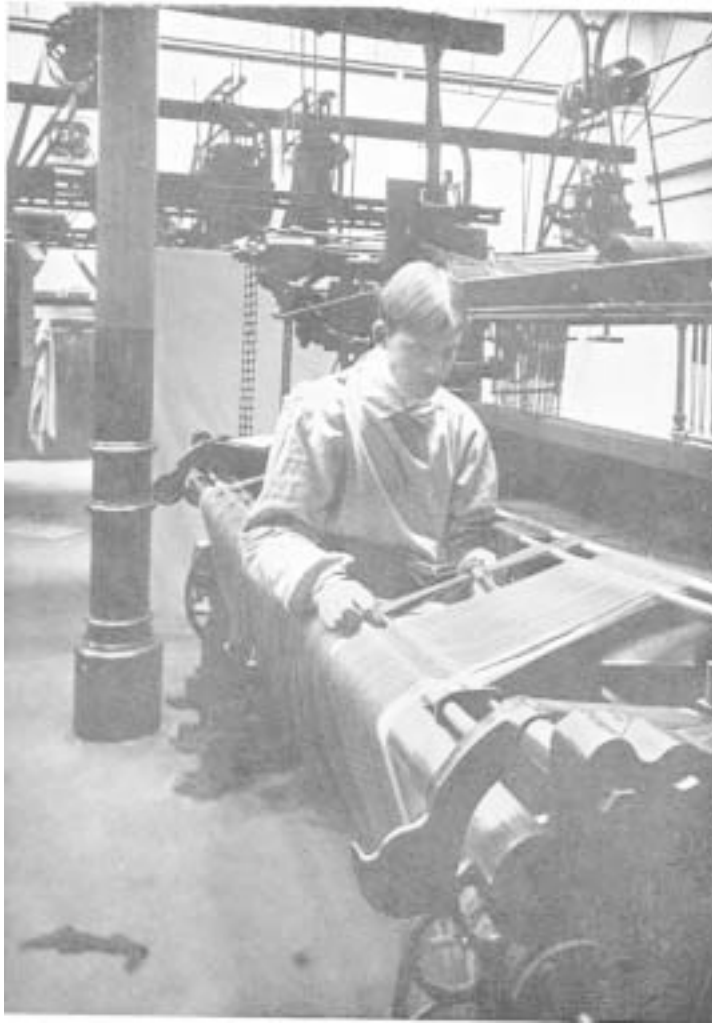

FIG. 25.—'TWISTING-IN' THE NEW WARP TO THE OLD WARP

particular mail on a particular shaft ; thus absolute accuracy of arrangement throughout is obtained.

A considerable amount of space has been devoted to preparation for the loom because this is the basis of good weaving ; but this treatment is not by any means of a really detailed character, for books might be written on this subject alone.

CHAPTER III

THE HAND AND THE POWER LOOM

DEFINITION OF WEAVING.—The interlacing of threads, usually at right angles to one another, to form a firm wearable texture.

Definition of a Loom.—A mechanism, worked either by hand or power, which effects the following prime or necessary movements :

1. The lifting of the healds to form a ' shed ' or opening for the shuttle to pass through.
2. The throwing-in of the weft by means of the pickers and the shuttle.
3. The beating-up of the weft, left in the shed by the shuttle, to the cloth already formed.
- 4 and 5. The winding-up or ' taking-up ' of the cloth as it is woven, and the ' letting-off ' of the warp as the cloth is taken up.
6. Where several colours of weft are required the manipulation of the boxes to present the right colour to the picker on a level with the shuttle-race.

PARTS OF THE HAND-LOOM

The parts of the hand-loom which effect the above-mentioned movements are as follows :

1. *The Healds*.—The making and arrangement of these have already been dealt with. They are the most important feature in a loom, as they control the movement of the warp, and, consequently, the resultant style of interlacing.

2. *The Dobby*.—This is the mechanism which forms the ‘shed’—*i.e.*, which actuates the healds in the required order. In the simplest form of hand-loom, levers and cordage take the place of the dobbie; the loom is then termed a ‘treadle-loom.’ If the dobbie simply lifts up the heald-shafts (*i.e.*, has no action on those left down), then an ‘undermotion’ is required to hold down the healds not lifted. The treadle-loom and some dobbies, however, positively lift up the healds to be lifted and positively depress those to be left down.

3. *The Going Part*.—This is the frame-work forming the shuttle-race and carrying the reed and shuttle, or shuttles, as already explained. In most hand-looms it is swung from the top—*i.e.*, ‘over-swung,’ as shown in Fig. 14; in most power-looms it is pivoted on or near the bottom of the loom—*i.e.*, ‘under-swung,’ as shown in Figs. 30, 32 and 34.

4. *The Cloth-Beam or Roller*.—This is suitably arranged to wind up the cloth as woven, being usually driven from the action of the ‘going-part’ by one means or another.

5. *The Warp-Beam*.—This is suitably fixed at the back of the loom, and, as a rule, is ‘braked’ by the friction of a rope or chain on one end of the beam or on a specially made ‘collar,’ so that the winding-up of the cloth draws off the required length of warp, at the same time maintaining a regular tension.

The foregoing are the general outlines applying, practically, to all looms; attention must now be directed to

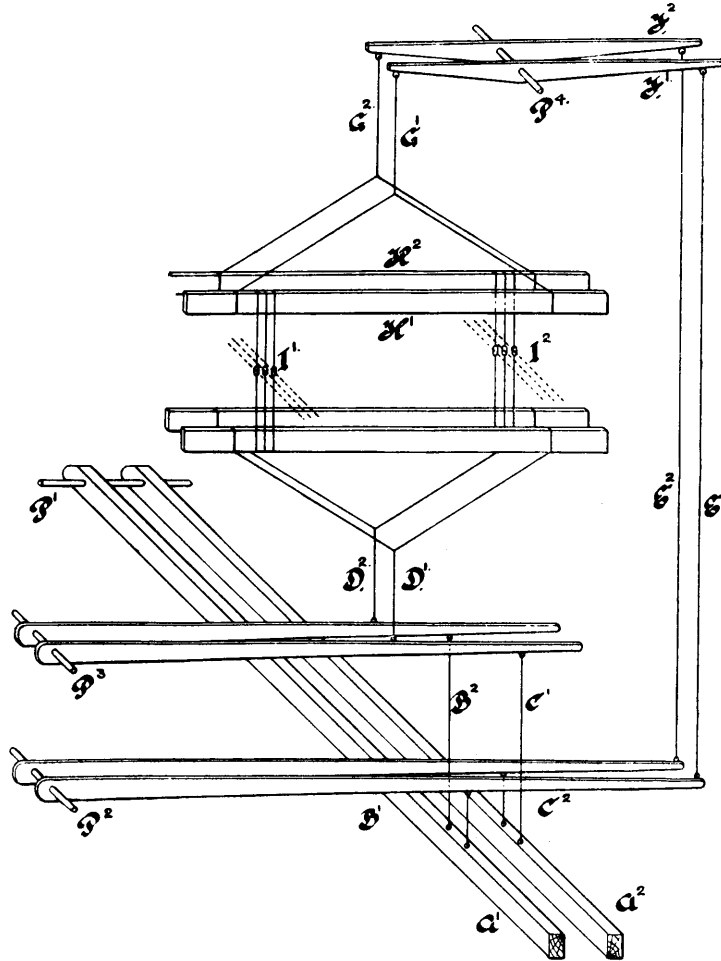

FIG. 26.—THE ARRANGEMENT OF LEVERS AND CORDS FOR WEAVING ON THE TREADLE-LOOM. (From the work of M. Édouard Gand)

several types of hand-looms, power-looms, and figuring-looms (hand or power), known as Jacquards.

THE TREADLE HAND-LOOM

The oldest and simplest form of hand-loom is illustrated in Fig. 26, in which the idea is to actuate the healds from a set of treadles which may be pushed down by the weaver's feet according to requirements. The main parts are the jack-levers (F), from which the healds are swung; the streamer rods or cords (E), connecting the jack-levers to the long lames or shafts (P^2); the short lames or shafts (P^3), which are attached to the lower parts of the healds; and, finally, the treadles (A^1, A^2), upon which the weaver's feet play, *each of which must be attached to all the healds by either short lames or long lames*; if a short lame the heald-shaft is depressed, if a long lame the heald-shaft is elevated. The shed is thus formed on the centre-close-shed principle, single lift.

As each treadle acts in one way or the other on every heald, it will be evident that by tying up each treadle to long and short lames as required any given pick or lift of the healds can be effected. *Thus a treadle represents a pick, and designing on this loom is effected by tying up a treadle to form each particular shed or pick, and then treading these treadles in the right order.*

It is obviously very inconvenient to have to re-tie the treadles for new plans, hence the witch—a machine invented much later than the treadle-loom—is almost universally employed for pattern work. It is arranged in two forms, which must now be briefly considered.

THE BOTTOM-SHED WITCH OR DOBBY

This is illustrated in Fig. 27. The main idea is to actuate a greater number of shafts more easily than is

possible on the treadle-loom, and also to change the order of lifting (*i.e.*, the interlacing of the threads) more readily. The machine may be studied in three parts—viz. :

1. *The Swinging of the Healds.*—Each heald is conveniently swung from a hook or upright, which forms a means of lifting the heald when required. Weights or springs suitably applied depress the healds.

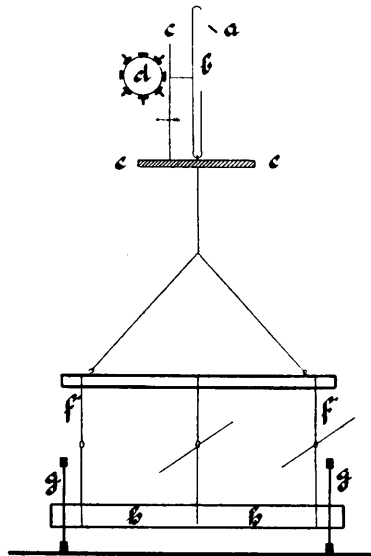

FIG. 27.—THE BOTTOM-SHED WITCH HAND-LOOM

2. *The Motive Power.*—This is produced by the weaver actuating the treadle, which in turn actuates a knife over which are suitably placed the hooks or uprights, upon which the healds are swung.

3. *The Selecting Mechanism.*—This is a simple arrangement for selecting the healds which are to be lifted by the knife. It consists of an eight-sided wood cylinder which

suitably presents long strips of wood, termed 'lags,' in which pegs are driven (according to pattern) to the springs (C). These springs keep the uprights off the knife, but upon a peg pressing against one of these springs the upright is pushed over the knife, and thus the heald is lifted as the knife is lifted from the treadle pressed by the weaver's foot. To produce any required pattern on this loom, then, a set of lags are taken, and for every pick in the design a lag is taken and pegs inserted opposite the healds required to be lifted; thus pegs = warp up, as shown in Fig. 28, in which A is the design and B the pegged lags. Of course, there must be perfect coincidence in pitch between the holes in the lags and the springs and uprights in the dobbie. The lifting of the knife turns the cylinder, and thus presents a new lag to the springs and uprights.

THE CENTRE-SHED WITCH OR DOBBY

This is illustrated in Fig. 29. In the main it is identical with Fig. 27, but if a heald-shaft is not lifted up *it is drawn down*. Instead of weights or springs for the under-motion, a positive action in the shape of levers is employed, from which cords (*i*) go to each succeeding upright (*b*¹).

This upright is linked to the lifting upright of the same heald, so that as a peg pushes upright (*b*) on to the knife it pushes (*b*¹) off the knife, while if there is no peg upright *b*¹ is drawn over the knife by the spring, and upon the knife being lifted the corresponding heald is drawn down. The knife is double-edged, so that hooks in either of the two rows of uprights may be lifted as required. In every pick some healds will be lifted and some depressed, and as those uprights which are lifted—whether lifting or

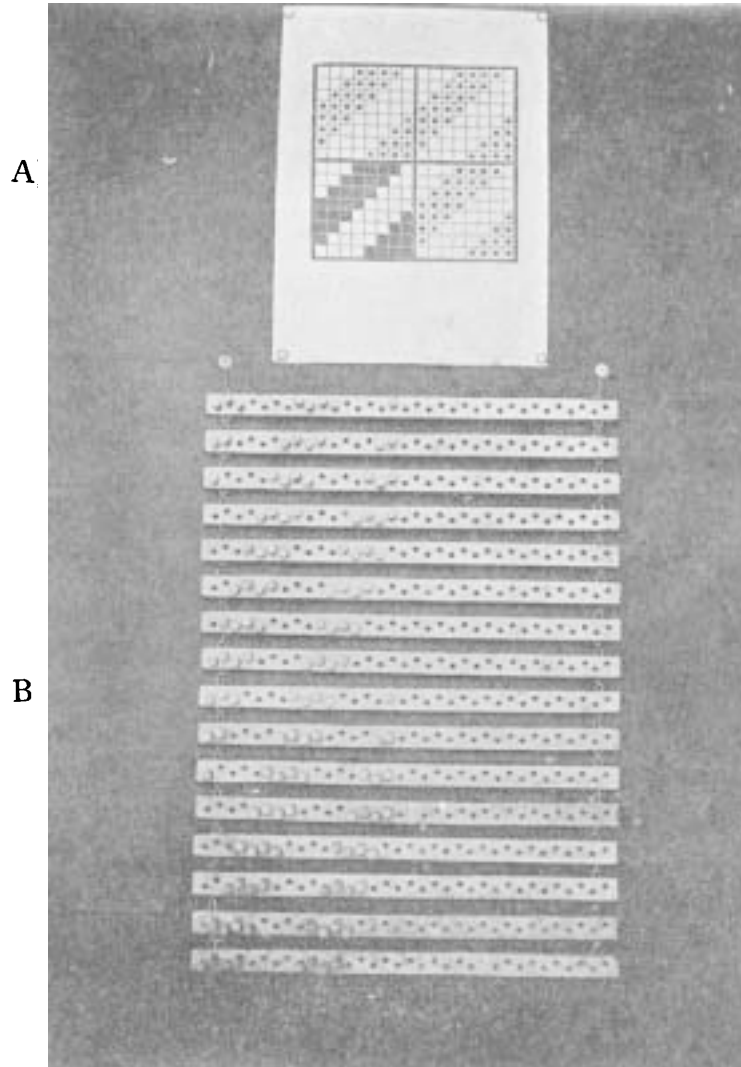

FIG. 28.—THE RELATIONSHIPS OF POINT-PAPER DESIGN AND PLAN AS PEGGED ON A SET OF HATTERSLEY LAGS

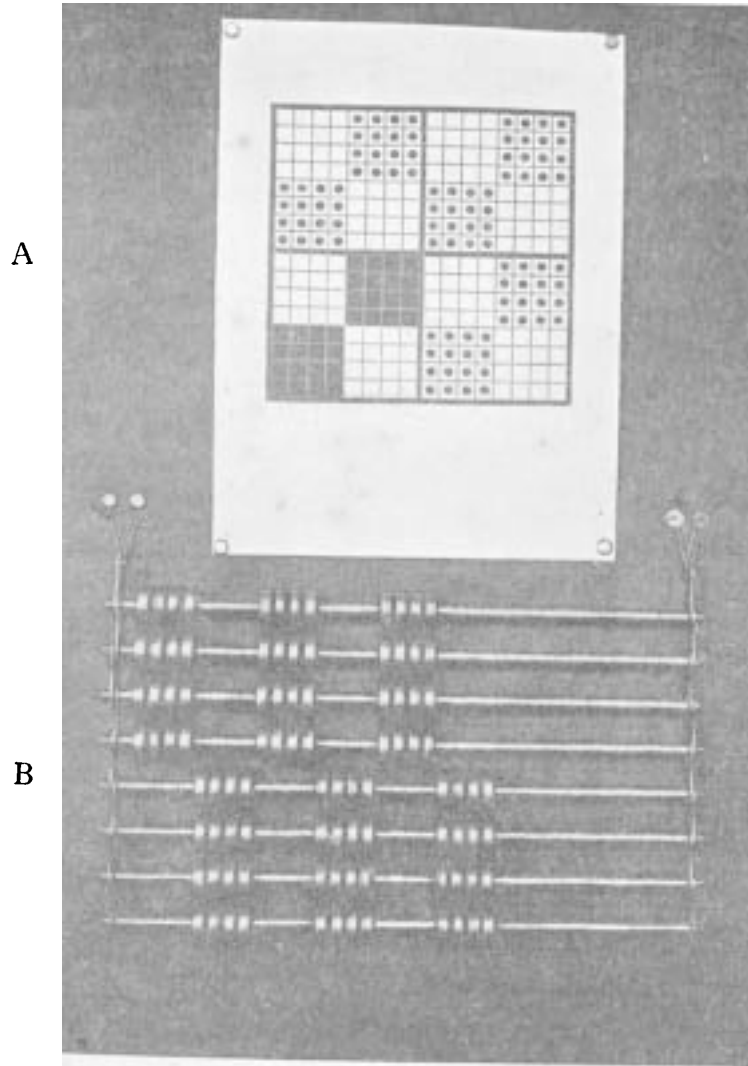

FIG. 28A.—THE RELATIONSHIP OF POINT-PAPER DESIGN AND PLAN AS CONSTRUCTED ON A SET OF HUTCHINSON AND HOLLINGWORTH'S BOWLS AND BUSHES

depressing uprights—depress those which are not lifted
it is necessary to swing the base board, upon which all

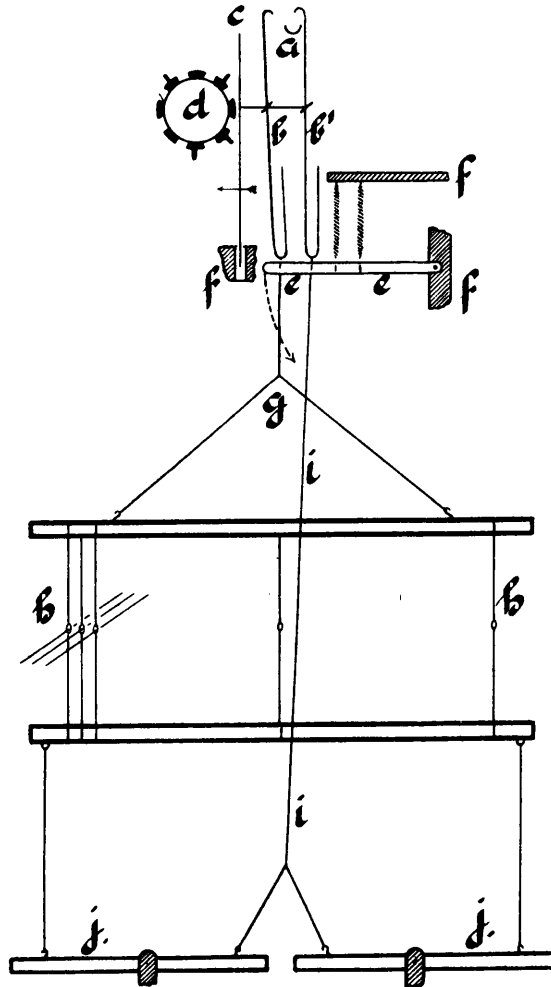

FIG. 29.—THE CENTRE-SHED WITCH HAND-LOOM

the uprights in the down position rest, with springs, so
that it may be drawn down.

The picking, taking-up, letting-off, and boxing actions will be best understood when considered with reference to the power-loom.

THE POWER-LOOM

There are three great types of power-loom—viz., the Tappet loom (Figs. 30 and 31), the Dobby loom (Fig. 32), and the Jacquard loom (Fig. 34).

The chief advantage of the Tappet loom is its quick and regular action, enabling cloth to be quickly woven and at the same time giving the overlooker complete control over the action of the warp, and consequently a better chance of making a more satisfactory cloth than in the case of either the Dobby or Jacquard loom. Its chief disadvantage is its very limited capacity for weave effect, about twelve shafts being the greatest practical number. A sectional view of a tappet shedding motion is given in Fig. 31, from which the action in a general way will be understood.

The chief advantage of the doobby is its greater capacity, working up to thirty-six or forty-eight shafts, and the readiness with which the pattern may be changed. Wooden lags and pegs are frequently employed, but spindles, bowls, and bushes (Fig. 28A) are more certain. In other respects the action of the tappet loom is copied as closely as possible, since it cannot be improved upon.

The chief advantage of the Jacquard is its greater figuring capacity, working in its simplest form about 100 different orders of threads (healds or neck-bands), and in its more complex form up to 1,800 different orders of threads. Thus, if a warp contains 1,800 ends, every end

may be worked independently. Taking an ordinary 400 Jacquard, which is usually cast down to 384 uprights

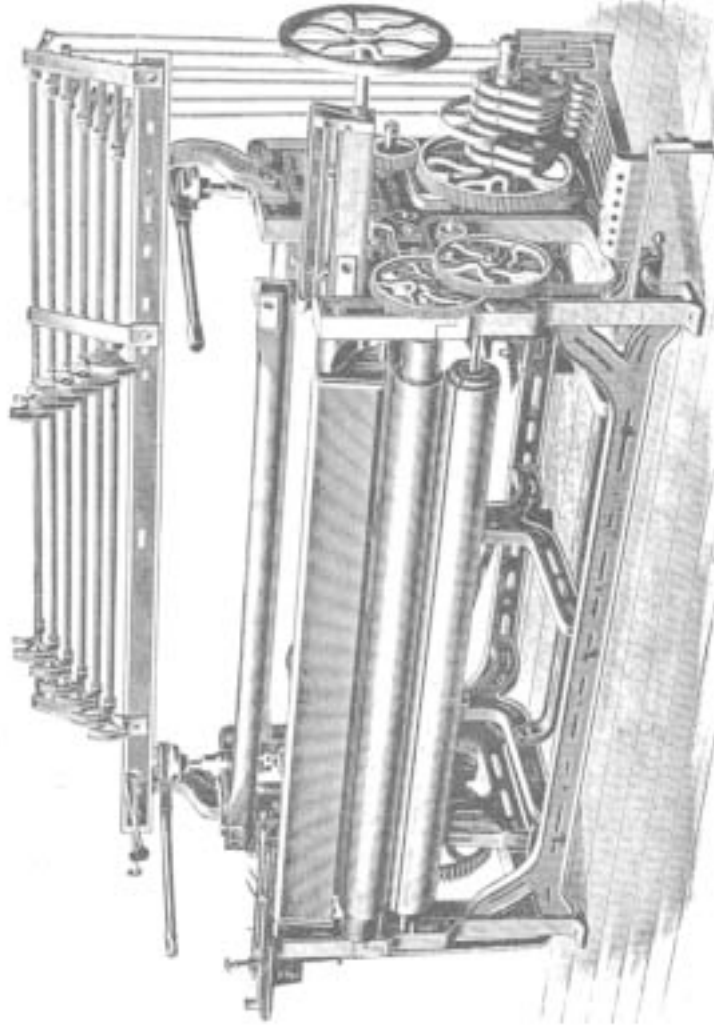

FIG. 30.—THE ORDINARY PLAIN OR TAPET LOOM. (As made by Messrs. Geo. Hodgson, Ltd.)

(or orders of threads, or neck-bands, or shafts), weaves on the following numbers of threads may be woven

without changing the loom in the least, fresh cards (or lags) only being required; 384 includes 2, 3, 4, 6, 8, 12, 16, 24, 32, 48, 64, 96, 128, and 192.

If a 600 Jacquard engine is employed, an even greater

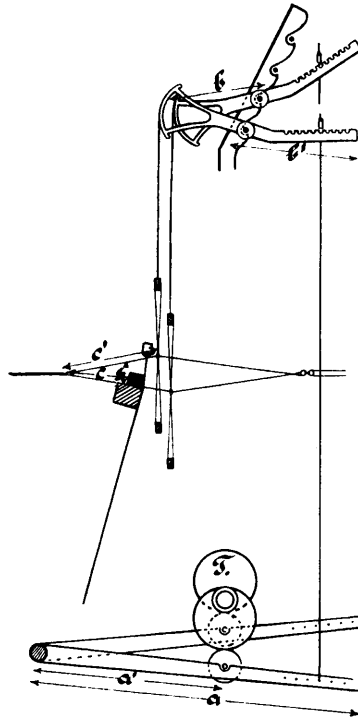

FIG. 31.—SECTION OF TAPPET LOOM

variety of weaves may be woven without any rearrangement.

The most common sizes of Jacquards are as follows :

192 and 384 Jacquards for Huddersfield, Leeds,
Manchester and Macclesfield.

300 and 600 Jacquards for Bradford.

1,800 Jacquards for Belfast.

The Picking and Boxing Motions.—The arrangements made for picking and boxing in the power-loom (*i.e.*, changing the shuttles) may be summed up very briefly. The pickers at each end of the loom always move in the

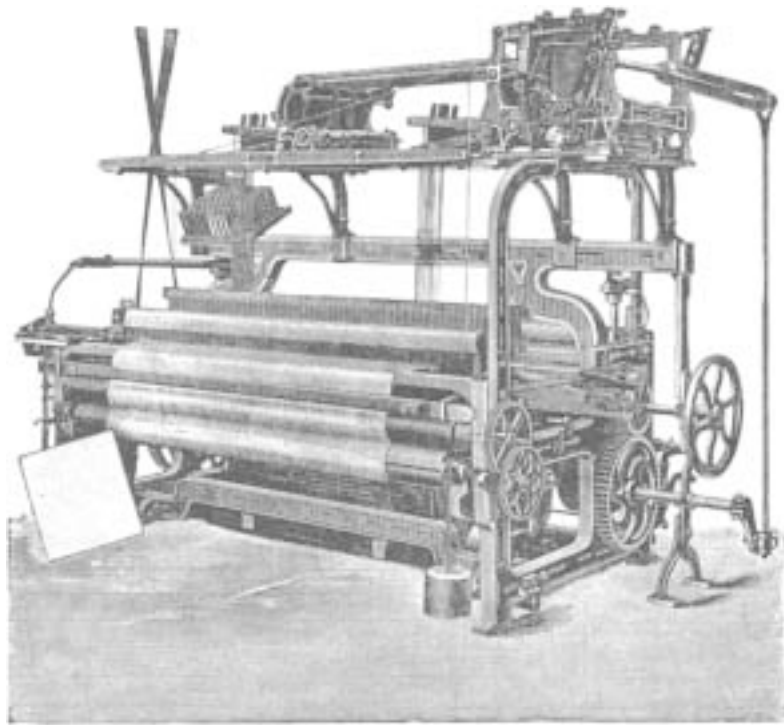

FIG. 32.—DOBBY LOOM. (As made by D. Sowden and Sons)

same plane, and in a plain loom throw one shuttle alternately from side to side.

If boxes are applied, these simply present the required shuttle in the 'picking plane'; hence it is picked across.

If there are boxes at one end only, unless *special*

arrangements are made, no single or odd number of picks can be inserted, as the shuttle must always travel to the single box side and back again before any change can be made; hence picking is alternately first from one side and then the other.*

In looms with boxes (say, four at each side), not only must there be an automatic control for the boxes, but also for the picking, as it may be necessary to pick two, three, or four times from each side. With four boxes at each side, four shuttles, as a rule, are employed, but it is possible to employ seven.

Boxes are made in two forms—viz., circular (usually six to the round) and rising boxes. The former are employed for light work, in which fine yarn may be wound on to a smallish spool fitting a small shuttle; and the latter for heavy yarns, which require a large bobbin shuttle in order to keep the loom running for a fair time without the necessity of changing the spool.

The Beating-up Mechanism.—This is effected by the ‘going part’ carrying the reed, etc. The simplest method of driving the going part is from two bends or ‘cranks’ on the main shaft of the loom; hence the term ‘crank-shaft.’ When the action of the going part in beating-up is considered, it will be obvious that this crank method, when possible, is by far the best; for the reed in an ordinary Bradford loom may deliver, say, 200 strokes per minute hour by hour, day by day, month by month, and

* Single picks may be inserted by throwing the shuttle in either its 1st or 2nd pick over or under the entire warp. But it does not follow that one pick of the material must be wasted, although the time certainly is. The student should think this out and draw diagrammatic illustrations.

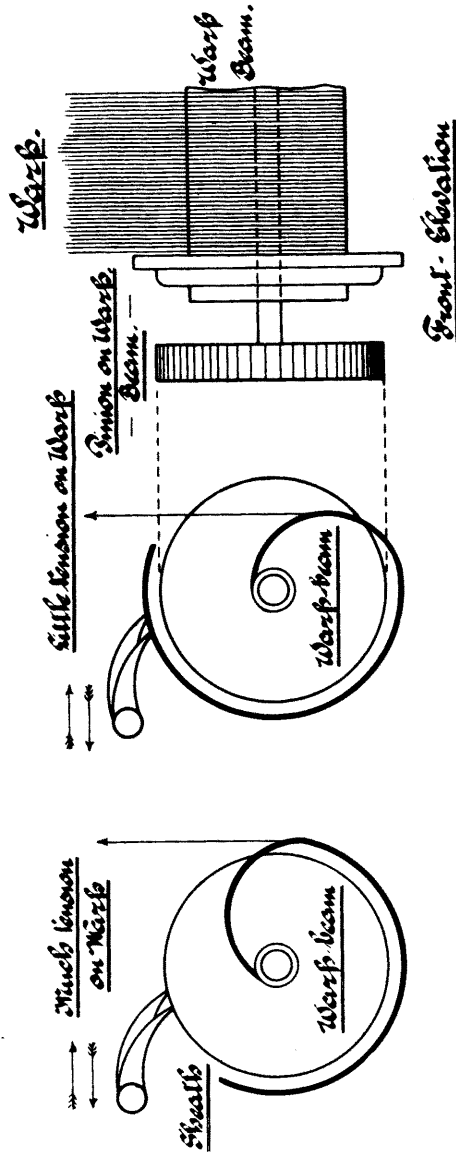

FIG. 33.—ILLUSTRATING THE REGULATIVE ACTION OF THE WARP TENSION ON THE LETTING-OFF FROM THE WARP-BEAM

year by year. It is evidently necessary to drive in such a way that slipping is absolutely impossible.

Taking-up and Letting-off.—These are important motions, as not only do they regulate the thickness of the cloth by controlling the picks per inch, but upon their regular action the regularity of the cloth depends. As a rule, these two motions are worked together, the taking-up effecting the letting-off. This is not always so, however; hence we find positive and non-positive (or negative) systems of both taking-up and letting-off.

In practically every power-loom the action of the going part gives motion to a train of wheels which in turn drives the piece-beam (winding up the cloth) by friction (not directly, or else, as the beam gained layer upon layer of cloth, fewer picks would be put in). By a 'change-wheel' the picks per inch may be regulated.

In the 'positive letting-off motion' the warp-beam is driven positively from either the going part or from a tappet on the crank or low shaft. But as the warp-beam decreases in size less and less length would be let off. To compensate for this the tension of the warp (as shown in Fig. 33) regulates the positive driving motion. So long as the required tension of the warp is maintained, giving the required picks per inch owing to the regular action of the positive taking-up motion, the warp-beam is slowly rotated; should the tension be too great (*i.e.*, does the taking-up motion require more warp), it keeps the positive motion closer in gear and thus lets off more warp; should the warp be too slack, the letting-off stops until the normal tension is again attained. It should be noted that the action of the mechanism is really most fine, so that,

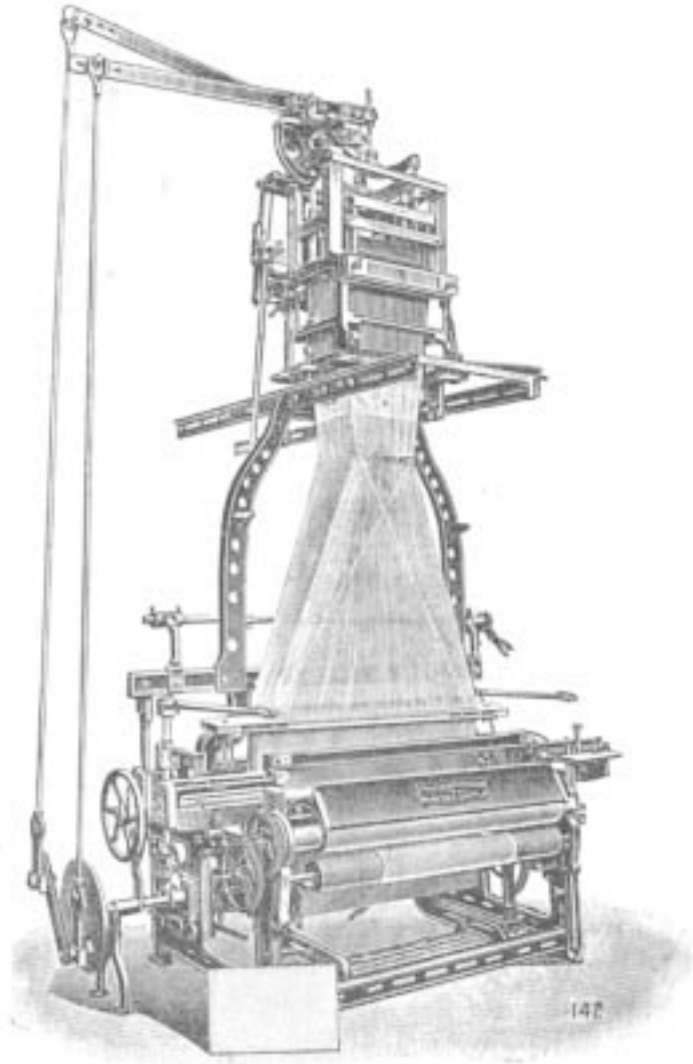

FIG. 34.—JACQUARD LOOM

although it is continually readjusting itself, a cloth which would take 100 picks per inch may be woven with 50 picks per inch and yet show no weft-bars.

The non-positive letting-off motion simply consists of a friction motion (there are several forms) applied to 'brake' the warp-beam so that the positive taking-up motion draws off just the warp required, and maintains a suitable tension. There are other forms of positive and non-positive combinations, which need not be considered here.

There are several accessory motions which there is not space here to deal with, as they have no material influence on the designing of textile fabrics.

The Jacquard loom is illustrated in Fig. 34, but its consideration in detail must be reserved for a future treatise, as only the elements of designing are here dealt with.

The foregoing particulars are all that a young designer need really be acquainted with; when the principles of designing have been thoroughly grasped, then a detailed study of the loom in its multifarious forms is most desirable.

CHAPTER IV
THE SCIENCE AND ART OF CLOTH
CONSTRUCTION

IF an engineer were about to build a Forth Bridge or an Eiffel Tower he would naturally consider—

1. The materials to be employed.
2. The conditions under which the materials could be employed to the greatest advantage.

Similarly with the textile designer ; he should thoroughly understand, firstly, what his materials are, their properties and possibilities ; and, secondly, how they may be employed to the greatest advantage. It is evident that scientific principles largely enter into such a construction as the Forth Bridge, but one questions at once whether similar principles can be applied in the case of yarn and cloth structures. Iron is relatively a stable factor ; stress and strain and leverage, etc., can be calculated, but what can be done with such an unstable material as wool, and how can the influences of the various yarns, the bending capacities, etc., in the case of cloth structures be estimated for ?

Now, this is certainly a legitimate question, but instead of making us ridicule the idea of scientific principles applied to cloth construction it should rather emphasize

the necessity of such principles. For the word 'science' betokens *an attitude or quality of mind* as much as material organization, and it is evident that the more diverse and diffuse the subject, the more is a scientific attitude of mind desirable. Thus no apology is necessary for the following treatment. True, it is a basis of action rather than action itself, which is here laid down; but this may be said of any science. Upon this Science of Cloth Construction may be built up the Art of Cloth Construction.

THE NUMBERING OF YARNS—*i.e.*, THE 'COUNTS' OF YARNS

It will be evident to the most casual observer of textile structures that yarns of various thicknesses are employed, and that some means of indicating the thickness must be adopted. From the designer's point of view yarns should be numbered according to their diameters—*i.e.*, a yarn with a diameter of one-eightieth part of an inch should be 80's, with one-fortieth part of an inch a 40's, and so on—so that with a moment's thought he could estimate the number of threads and picks per inch (an inch being the most convenient measure) for any simple structures, such as plain cloth, $\frac{2}{2}$ twill, etc.

The financial aspect intervenes, however. For the yarn buyer must know what *length and weight* of yarn he is purchasing, whatever the diameter may be. Thus he knows how much he will have to pay and what lengths of warps and weights of pieces can be made from a given batch of yarn.

As weight affords the most ready means of estimation, almost all yarns are sold and bought by weight, and the length is stated by indicating the yards to which one pound of material is extended. A further complication, however, arises by reason of different kinds of yarns being measured on different sizes of reels. Thus the worsted reel is 1 yard round, 70 yards or revolutions



$$40 \times 560 = 22400 \text{ yds per lb.} = 40's \text{ Worsted.}$$

A



$$10 \times 560 = 5600 \text{ yds per lb.} = 10's \text{ Worsted.}$$



$$40 \times 840 = 33600 \text{ yds per lb.} = 40's \text{ Cotton.}$$

B



$$10 \times 840 = 8400 \text{ yds per lb.} = 10's \text{ Cotton.}$$

FIG. 35.—GRAPHIC ILLUSTRATIONS OF YARN COUNTS

give a 'rap,' and 8 'raps' are made up into a hank; thus the worsted hank = $70 \times 8 = 560$ yards, and the counts of a worsted yarn is really the hanks per pound.

Example 1.—40's count = 40 hanks of 560 yards = 22,400 yards per pound.

Example 2.—10's count = 10 hanks of 560 yards = 5,600 yards per pound. (See Fig. 35, A.)

The cotton reel was $1\frac{1}{2}$ yards in circumference, hence the cotton hank is $560 + \frac{1}{2}(560) = 840$ yards; but as with worsted the hanks per pound equal the counts.

Example 1.—40's count = 40 hanks of 840 yards = 33,600 yards per pound.

Example 2.—10's count = 10 hanks of 840 yards = 8,400 yards per pound. (See Fig. 35, B.)

For practical calculations it is desirable to take all the materials with which one has to deal, and work out the yards per hank on the supposition that the hanks per pound give the counts. Thus the following list would be kept in view by a Yorkshire manufacturer.*

METHODS OF COUNTING YARNS.

<i>Type of Yarn.</i>	<i>Basis of Counts.</i>	<i>Per Hank.</i>
WOOLLEN :		
Leeds	1,536 yards = 6 lb.	256 yards
Galashiels	300 " = 24 oz.	200 "
West of England	320 " = 16 oz.	320 "
American 'Run'	1,600 " = 1 lb.	1,600 "
American 'Cut' ...	300 " = 1 lb.	300 "
WORSTED	560 " = 1 lb.	560 "
COTTON	840 " = 1 lb.	840 "
LINEN	300 " = 1 lb.	300 " (per 'lea')
SILK :		
Spun	840 " = 1 lb.	840 "
Tram	Weight in drams of 1,000 yards	1,000 "
Organzine	Yards per oz. †	
METRIC OR CONTI-		
NENTAL	Metres per kilogramme	1,000 metres
FRENCH	Metres per half kilo- gramme	1,000 "

It will now be evident that the manufacturer, in purchasing yarns, will know on the one hand that he has to

* At the end of the book a graphic diagram for converting one system of yarn counts to another is given ; the student will find it both useful and instructive.

† Thus, $2/7,000 = 7,000$ yards per oz., the thread being in two strands. A loss of one-third is allowed in ungumming ; thus $2/6,000$ becomes $2/8,000 = 8,000$ yards per oz.

pay for so many pounds, and on the other hand that he has a certain length of yarn from which he can make a certain length of cloth.

In one case it is evident that length has been deemed more important than weight, for in Bradford weft-yarns are sold by the 'gross of hanks'—*i.e.*, 144 hanks of 560 yards each—of which the weight will, of course, depend upon the counts. Supposing the counts to be 36's, then—

$$\frac{560 \times 144}{560 \times 36} = 4 \text{ lb.}$$

From this it is evident, since the two 560's cancel one another, that :

To Ascertain the Weight of a Gross of Hanks of any given Count

Method.—Divide 144 by the counts, and the result is the weight in pounds.

Example 1.—Find the weight of a gross of 40's botany :
 $144 \div 40 = 3.6$ pounds.

Example 2.—Find the weight of a gross of 72's botany :
 $144 \div 72 = 2$ pounds.

Shortened methods of this character are frequently employed by manufacturers, and every manufacturer should be capable of discovering easy and convenient methods on similar lines to this.

It will be noted that the defect of most of the systems in vogue for numbering yarns is that the heavier and thicker the yarns the less the count number, and the lighter the yarn the greater the count number. This is expressed by saying that counts vary inversely to the weight.

Example 1.—Comparing 8's and 16's counts: A given length of 8's is double the weight of the same length of 16's.

Example 2.—1 pound of 16's is double the length of 1 pound of 8's. Thus it is evident that counts correspond with length, and that counts and length vary inversely to weight.*

Denomination.—Care should be taken in dealing with the counts of a variety of yarns that they are all on the same basis—*i.e.*, that they indicate relatively, for example, the same number of yards per pound.

Example.—20's cotton yarn = 30's worsted yarn, for—

$$840 \times 20 = 16,800 \text{ yards per pound, and}$$

$$16,800 \div 560 = 30 \text{ hanks per pound—}i.e., \text{ 30's counts worsted.}$$

Rules for converting counts from one system into another may readily be originated if the yards per pound are first found. Perhaps the only difficult one is the dram silk counts, of which the following is an example:

Example.—Convert 5 dram silk into spun silk counts:

$$1,000 \text{ yards} = 5 \text{ drams, therefore}$$

$$\text{As } 5 : 256 :: 1,000 : x = 51,200 \text{ yards per pound.}$$

$$\text{and } 51,200 \div 840 = 60.9 \text{ 's counts in spun silk.}$$

The metric system† is based upon the kilometres (1,094 yards) per kilogram (2,204 pounds) and the French system is half the metric—*i.e.*, half a kilogram is the weight taken. The idea of taking fractional parts of the earth's circum-

* The student should here decide for himself whether in direct proportion or not.

† See Appendix, p. 202, for Fig. 48.

ference and of its weight as the standards of measurement has really no other claim in this case than the extended use of the metric system, and the fact that it is not exclusively employed by the French is practically a feather in the cap of our own English cotton trade, the counts of which (based upon practical requirements) and the French counts are nearly alike.

Ranges of Counts.—Most factories employ at least two or three ranges of counts. Thus, a fancy worsted manufacturer might keep in stock, say, twenty-eight shades of 2/16's serge yarns, of 2/28's botany, and of 2/48's botany.

Two-Fold Yarns.—If two threads of a given count (say, 40's) are twisted together, it will be evident that the count is just half that stated for—40 hanks* of 40's (=1 pound)+40 hanks of 40's (=1 pound) will give 40 hanks of twisted yarn=2 pounds, or 20 hanks per pound, and therefore 20's counts (Fig. 36, A).

If the threads twisted together are unequal in thickness, then a count heavier (*i.e.*, a smaller number) than the thickest component will be formed—*not a count in between the two.*

This will be realized from Fig. 36, B, in which is represented diagrammatically the twisting together of 30's and 15's worsted yarns. As shown at A, a *convenient* length must be taken to base the estimate on; in this case 1 pound of the highest numbered counts (30's) is the standard, giving $560 \times 30 = 16,800$ yards=1 pound. To twist with this it is evident that 16,800 yards of 15's must be taken, weighing 2 pounds; therefore the length

* The word 'hanks' stands for length.

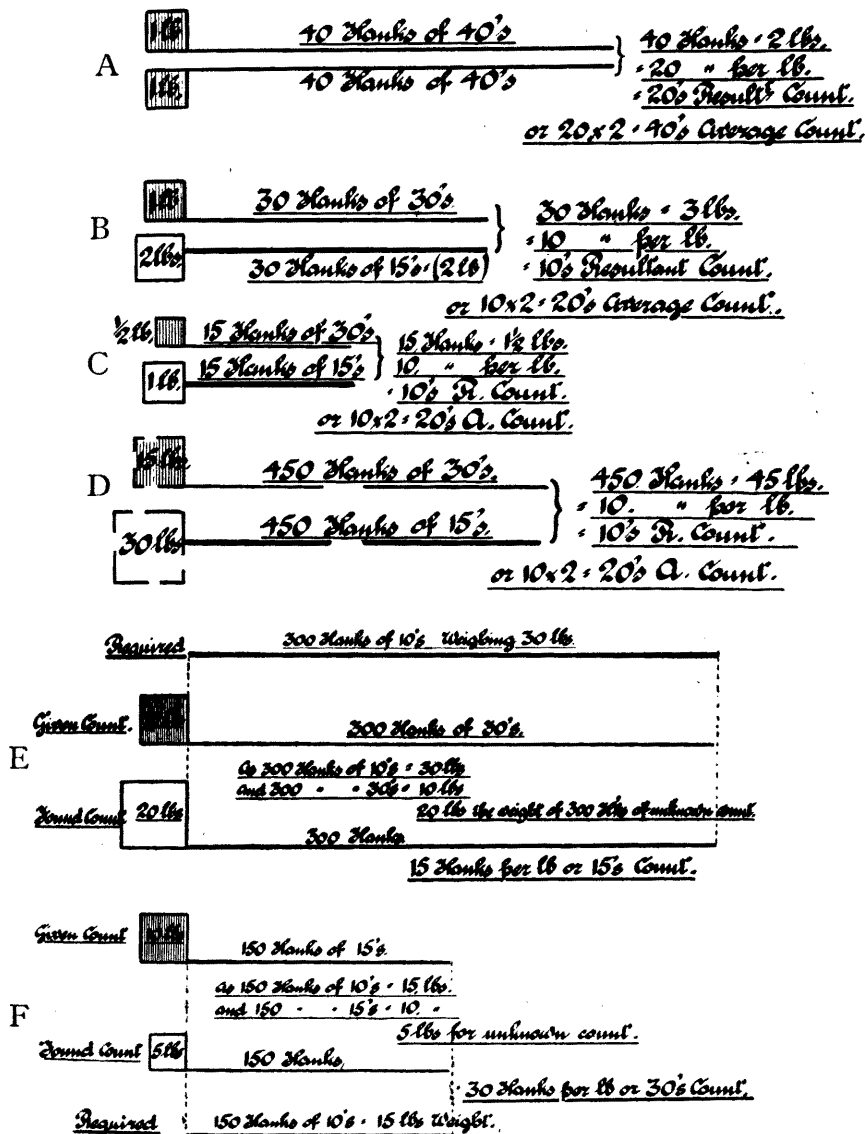

FIG. 36.—GRAPHIC ILLUSTRATIONS IN TWISTING YARNS (Black weights are given ; white weights are to be found)

of two-fold yarn will be 16,800 yards, weighing 3 pounds

$$= \frac{16,800}{560 \times 3} = 10 \text{ hanks of two-fold yarn per pound, or } 10\text{'s}$$

'resultant' counts.

The 'average' counts will be $10 \times 2 = 20\text{'s}$.

This is all conveniently summed up as follows :

$$30 \div 30 = 1$$

$$\frac{30}{30} \div 15 = 2$$

$$30 \div 3 = 10\text{'s 'resultant' counts or } 20\text{'s 'average' counts.}^*$$

But it is not necessary to take the highest count (30's) as the standard. With the lowest count as the standard the result is :

$$15 \div 30 = 0.5$$

$$\frac{15}{15} \div 15 = 1.0$$

$$15 \div 15 = 10\text{'s 'resultant' counts or } 20\text{'s 'average' counts.}$$

Again, the same result may be obtained by multiplying the two counts together, adding the two counts together, and dividing the one by the other. This is summed up as follows :

$$\frac{30 \times 15}{30 + 15} = \frac{450}{45} = 10\text{'s 'resultant' counts or } 20\text{'s 'average' counts.}$$

The question may also be put in the following form :
What counts of yarn must be twisted with 30's to yield a

* The student should exercise himself in casting these two-fold yarns : the principle involved is so simple that it is not considered advisable to give it here.

10's resultant counts, or with 15's to yield a 10's resultant count. These two problems may be stated :

$$\frac{30 \times 10}{30 - 10} = \frac{300}{20} = 15\text{'s yarn required to yield with 30's a resultant count of 10's.}$$

$$\frac{15 \times 10}{15 - 10} = \frac{150}{5} = 30\text{'s yarn required to yield with 15's a resultant count of 10's.}$$

These varieties of the same calculations are clearly shown in Figs. 36, A to F.

Of course, in estimating either the resultant or the average counts the yarns must be expressed in the same denomination, or incorrect results will be obtained. Thus the following example shows another method of working (which the student should think out), and at the same time illustrates the necessity of bringing to the same denomination.

Example.—Find the resultant counts of 20's cotton and 40's worsted twisted together.

$$20\text{'s cotton} = \frac{20 \times 840}{560} \text{ or } \frac{20 \times 3}{2} = 30\text{'s worsted counts.}$$

$$\frac{30 \times 40}{30 + 40} = \frac{1,200 \text{ hanks}}{70 \text{ lbs.}} = 17.1 \text{ hanks per lb.} = \text{about } 17\text{'s counts of worsted.}$$

Or,

$$40\text{'s worsted} = \frac{40 \times 560}{840} \text{ or } \frac{40 \times 2}{3} = 26.6 \text{ cotton counts of 40's worsted.}$$

$$\frac{20 \times 27}{20 + 27} = 11.5 \text{ resultant counts in cotton.}$$

Proof :

$$\frac{11.5 \times 3}{2} = 17\text{'s resultant counts in worsted, as already ascertained.}$$

This is not, strictly speaking, a proof, but practically it may be taken as such. Students should check their calculations in this way whenever possible.

THE DIAMETER OF YARNS

It is evident from the foregoing that the idea of constructing cloths on scientific principles—based upon the *diameters* of yarns—had rarely or never occurred to our predecessors. In the early part of the past century, however, a Mr. Beaumont thought of this, and actually worked out or suggested that the diameters of yarns might be ascertained by noting how many threads and picks per inch could be laid side by side in a plain cloth with warp and weft of a similar thickness—*e.g.*, if forty, then, he argued, the diameter of the yarn would be one-eightieth part of one inch (see Fig. 1). The greatest impetus was given to this, however, by the measurements carried out in 1889 by the late Mr. T. R. Ashenhurst, and from his results a reasonable rule for finding the approximate diameter of any given yarn has been worked out.

To Ascertain the Diameter of any Given Yarn.

Method.—Find the square root of the yards per pound and extract 8 per cent.* for cotton and silk, 10 per cent. for worsted, and 15 per cent. for woollen.

Example 1.—Find the diameter of 1/40's botany—

$40 \times 560 = 22,400$ yards per pound, and

$\sqrt{22,400} = 149 - 10 \text{ per cent.} = 135$ or $\frac{1}{1\frac{1}{3}}$ part of an inch, or 135 threads would lie side by side in 1 inch.

* These percentages should be varied according to the designer's experience.

Example 2.—Find the diameter of 2/60's cotton—

$30 \times 840 = 25,200$ yards per pound, and
 $\sqrt{25,200} = 159.8$ per cent. = 148 or $\frac{1}{148}$ part of an
 inch, or 148 threads would lie side by side in
 1 inch.

Example 3.—Find the diameter of 20 skeins woollen—

$20 \times 256 = 5,120$ yards per pound, and
 $\sqrt{5,120} = 71.6$ per cent. = 60 or $\frac{1}{60}$ part of an inch,
 or 60 threads would lie side by side in 1 inch.

Variations in the Diameters of Yarns.

In buying yarns, the counts are always stated, but rarely or never the diameters. Nevertheless, the designer must know the approximate diameters under all conditions.

From one known count and diameter any other may be readily ascertained. To find the rule for this is most interesting and instructive, and as it may be readily understood by means of diagrams, it is here given in the hope that some of the more difficult problems may be treated by the student in a similar manner.

Let A, B, C, Fig. 37, represent the sections (made square instead of round for convenience*) of three yarns whose counts may be respectively 9, 4, 1—*i.e.*, counts are inversely to weight or area.†

* πr^2 = area of circle from which a precisely similar induction may be made.

† The student should prove to his own satisfaction that counts, weight, and area are in practically the same proportion; this may be done graphically.

1. From A one might suppose that diameter and area (= counts) would always be in the same proportion.

2. From B one might suppose that the diameter would be half the area—*i.e.*, area = 4, diameter = $4 \div 2 = 2$.

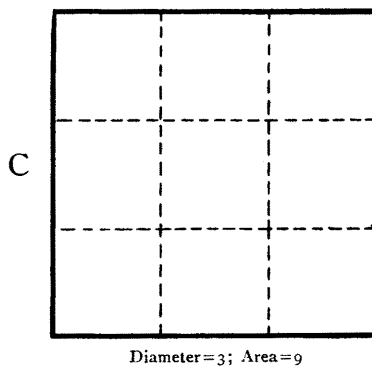
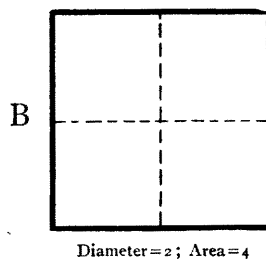
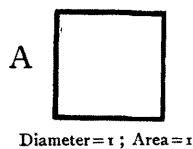

FIG. 37.—RESEARCH TO PROVE THAT THE DIAMETERS OF YARNS VARY AS SQUARE ROOT OF AREA (COUNTS)

3. On drawing C to prove this, the method is found incorrect, for $9 \div 2 = 4\frac{1}{2}$, whereas the diameter is 3.

It now occurs to the investigator that *possibly the*

diameter varies as the square root of the area (i.e., $\sqrt{\text{counts}}$), for $\sqrt{1}$ is 1, $\sqrt{4}$ is 2, $\sqrt{9}$ is 3.

4. To test whether this is so or not draw a diagram D, in which area (= counts) is 16 and $\sqrt{16}=4$ the diameter.

On referring to p. 68 it will be seen that when dealing with the diameters of yarns it is stated that the diameters vary as the square root of the length. From Fig. 38 it will be realized that length and area vary in the same proportion, inversely—extend a mass to four times the length, and it is one quarter the area; extend it to nine times the length, and it is one ninth the area. Now, count is in direct proportion to length, therefore counts and areas are in proportion (inversely) to one another. Further, as the square root of an area equals the diameter, therefore the square root of the count is in direct proportion to the diameter; hence the following rule.

To Ascertain the Diameter of any Yarn from a Known Count and Diameter.

Method.—Work out in proportion to the square root of the counts inversely.

Example.—A 1/40's yarn (denomination not necessary) has a diameter of $\frac{1}{135}$, what is the diameter of a 10's?

As $\sqrt{40} : \sqrt{10} :: 135 : x = 67\frac{1}{2}$ or $\frac{1}{67}$ of an inch;

or—

As $[\sqrt{40} : \sqrt{10} :: 135 : x]^2 =$

As $40 : 10 :: 135^2 : x^2 = 67$ or $\frac{1}{67}$ of an inch.

In order that calculations such as these may be readily solved it is useful to thoroughly realize and remember that







Counts per Inch	Relative Lengths of Counts.	Relative Areas per Inch	Counts per Inch
1			1
4			1/2
9			1/3

FIG. 38.—GRAPHIC ILLUSTRATIONS OF COUNTS, LENGTH, AREAS, AND DIAMETERS OF YARNS

the counts of a yarn is in proportion to the area and the square root of the counts to the diameter.

SETS AND SET CALCULATIONS

After studying the foregoing, the student would naturally take an inch as the unit of measurement, and state the set of the cloth as so many *threads per inch*. Two varying factors must, however, be taken into account: firstly, the practical fact that it is usually necessary to denote the splits or dents through each; and, secondly, that the standard width taken has unfortunately been varied from 1 inch up to 45 inches.

If the designer bases his art of cloth construction on the science of cloth construction,

he will always work by the threads per inch—just as the picks are counted in a cloth—and will indicate the reed along with the set by stating the dents per inch and the threads per dent; thus, 12's reed 4's = 48 threads per inch, as indicated in Chapter II.

The other most important systems are :

Leeds, based upon the porties (38 threads) in 9 inches.

Bradford, based upon the beers (40 threads) in 36 inches.

Blackburn, based upon the beers (40 threads) in 45 inches.

Manchester, based upon the splits (2 threads) in 36 inches.

Glasgow, based upon the splits (2 threads) in 37 inches.

The last two, perhaps, illustrate the absurdity of having these varied systems, but as they are in existence the designer must thoroughly study them and learn to express a given set in any of them. Thus : to convert a 12's reed 3's set into Bradford—

$$12 \times 3 = 36 \text{ threads per inch.}$$

$$\frac{36 \times 36}{40} = 32.4 \text{ Bradford set, or}$$

$$\frac{36 \times 9}{38} = 8.5 \text{ portie set, Leeds.}$$

$$12 \times 36 = 432 \text{ Manchester set, etc.}$$

The method of converting one set to the other is so very simple that any further treatment here is not required; the student should for himself arrange all the systems in list form for reference.

CLOTH CONSTRUCTION

The *practical* diameters of yarns may be made the basis of certain interesting and useful calculations for cloth structures. The building of cloths on scientific lines may be treated under two heads—viz., the principles govern-

ing the interlacing of flexible cylinders (representing threads) and the modifications which must be made in dealing with such variable materials as wool, cotton, silk, etc., in the equally variable yarn structures.

Elementary Considerations of Interlacings.—If reference be made to Fig. 39, the elementary principles governing interlacings may readily be realized.

In plain weave it is evident that every thread must be separated from its neighbour by about the diameter of

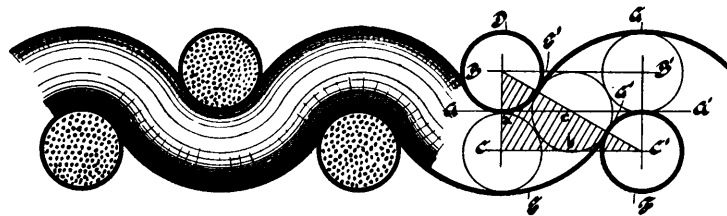

FIG. 39.—ILLUSTRATING THE THEORETICAL CONDITIONS OF A PERFECT PLAIN CLOTH

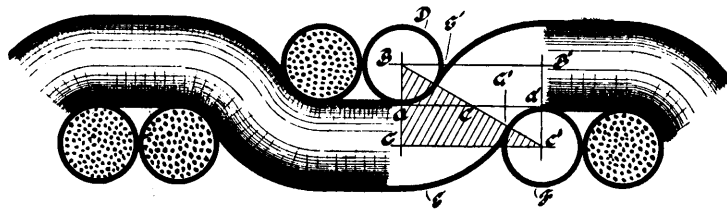

FIG. 40.—ILLUSTRATING THE THEORETICAL CONDITIONS OF A PERFECT $\frac{2}{2}$ TWILL CLOTH

the weft. So that if the warp and weft yarns are the same counts—say, 40's botany with a diameter of $\frac{1}{133}$ part of an inch—then $135 \div 2 = 67.5$ threads per inch will be required, and so on with yarns of other diameters.

In $\frac{2}{2}$ twill cloth the section (see Fig. 40) shows that the threads are grouped in pairs, each pair being separated by a weft intersection. Thus the calculation for the

threads per inch, taking 40's botany again, will be $(135 \div 6) \times 4 = 90$ threads per inch.

For simple cloths requiring to be woven on the square—*i.e.*, with an equal number of threads and picks—the above method works out satisfactorily for finding the set—*i.e.*, threads per inch in the loom, hence—

To Find the Set in the Loom for any Ordinary Weave, such

as Plain, $\frac{2}{2}$ Twill, $\frac{3}{3}$ Twill, etc.

Method.—Divide the diameter of the yarn by the threads + intersections, and multiply by the threads in the repeat of the weave.

Example.—Find the threads per inch for $\frac{2}{2}$ twill with a 20 skein woollen yarn ($\frac{1}{80}$ diameter).

$(60 \div 6) \times 4 = 40$ threads per inch in the loom.

No better *practical* rule than the above can be given ; but attention must be directed to where it fails in application, for a moment's consideration will serve to show that it will not serve under all conditions. The following are the chief modifying influences in cloth construction :

(a) Modifications in the bending influences caused by using yarns of various diameters, or by employing weaves which group together certain threads or picks, thus strengthening themselves and modifying the structure.

(b) Modifications of structure, *i.e.*, changing the supporting positions of both threads and picks.

(c) The averaging of the strain in fabrics—*i.e.*, the manner in which strains applied at one time and in one

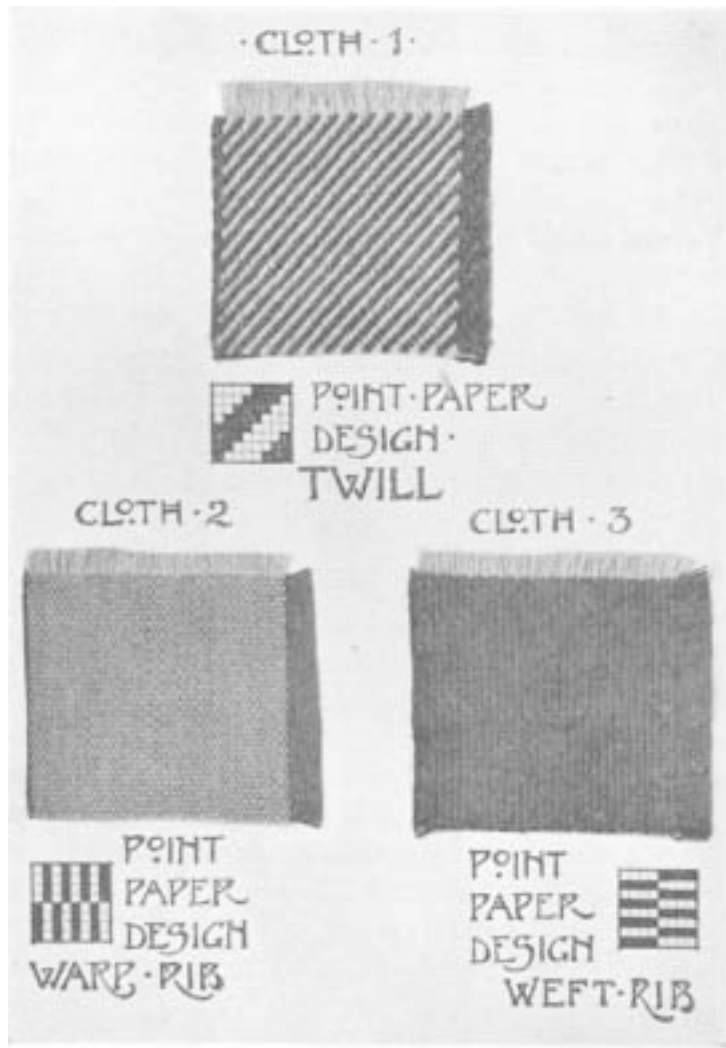

PLATE 2.—STANDARD WEAVES

part of the structure are sometimes distributed throughout the fabric.

(d) Modifications caused by building cloths with the idea of modifying the structure in the finishing operations (crabbing, etc.).

Before passing on to the consideration of each of the foregoing, attention must be directed to the fact that the deductions already made are slightly inaccurate, as the threads, for example, in perfect plain cloth will not be distant from one another quite the diameter of the weft taken here, for being slightly lifted and depressed alternately, *taken horizontally* they will be rather closer together. Mr. T. R. Ashenhurst was the first to point out that if yarns of equal thickness, and having practically an equal bending power on each other, were employed in warp and weft, then for warp and weft to attain to the same plane on each side of the centre of the cloth a curvature of 180° throughout—*i.e.*, for both warp and weft—is the result (or 60° with the altitude of the triangle, the known side—or 30° with the centre plane of the cloth).

This may be represented diagrammatically, as shown in Fig. 39.

Construction.—1. Draw A, A', representing the base-line or centre of the cloth; then warp and weft, being equal in flexibility, will be bent equally out of the straight line—*i.e.*, above and below this line.

2. At a distance half the diameter of warp (or weft) from A, A', rule in lines B, B', C, C', representing the centres of the warp-threads (or weft-picks) in their highest and lowest positions respectively.

3. Take any convenient position on B, and with radius

half diameter of yarn, describe circle D, representing the highest position of the warp-thread.

4. With radius half diameter of yarn multiplied by 3, describe circle E, representing the bending influence of thread D, upon the outer edge of weft, and E' for the inner edge of weft.

5. With half diameter of warp (or weft) and upon C, C', but tangential to E, describe circle F, representing the lowest position of the warp-threads.

6. With radius half diameter of yarn multiplied by 3 describe circle G, representing the bending influence of thread F upon the outer edge of weft and G' for the inner edge of the weft.

7. The weft will take the direction compounded of the action of the two spheres of influence, D and F, and the angle of the weft with A, A' will be 30° (or, with the known side of triangle, which is here shown; 60°).

For convenience the three sides of the triangle may now be represented by the letters *a*, *b*, and *c*.

We are specially concerned, however, with the ratio of *a* : *b*, for in using any given yarn its diameter = *a* and the threads per inch to be employed for plain cloth will be—

As *a* : *b*, inversely—*i.e.*,

As *b* : *a* ; or

As 1.732 : 1 :: diameter of yarn : the set ;

that is to say, for plain cloth divide the diameter of the yarn by 1.732, and the result is the set or threads per inch.*

Exactly the same principle applies in $\frac{2}{2}$, $\frac{3}{3}$, etc.,

* If C is employed as the unit of measurement (twice diameter of yarn), B=0.866, and two diameters of yarn may be taken.

twills and ordinary makes so far as the intersections are concerned. Thus in calculating the threads per inch for any of these structures proceed as follows :

1. Draw accurately a section of the cloth, being careful to draw more than one repeat *and then to mark off clearly the exact repeat.*

2. Find the number of repeats of the weave in 1 inch by dividing the diameter of the yarn by the units of space the weave occupies, threads counting as units and intersection as 0.732.

3. Finally, ascertain the threads per inch by multiplying the repeats of the weave per inch by the number of threads in each repeat of the weave.

Example 1.—Find the threads per inch for $\frac{3}{3}$ twill with a 32's worsted ($\frac{1}{16}$ diameter).

As $7.464^* : 1 :: 120 : x = 16$ repeats of $\frac{3}{3}$ twill,
and $16 \times 6 = 96$ threads per inch.

Or, to put it in its simplest form :

$$(120 \div 7.464) \times 6 = 96 \text{ threads per inch.}$$

Example 2.—Find the threads per inch for $\frac{2}{2}$ twill (see Fig. 40) with a 20 skein woollen yarn ($\frac{1}{60}$).

(1) 4 threads + $(2 \times 0.732) = 5.464$ units of space in $\frac{2}{2}$ twill.

(2) $(60 \div 5.464) \times 4 = 44$ threads per inch for $\frac{2}{2}$ twill.

Thus it will be evident, as was to be expected, that on this system the sets obtained are rather closer than those

* The 7.464 is composed of 6 threads + $2(0.732)$ intersections = 7.464 units of space the weave occupies.

obtained by the previous system (see p. 75). Roughly speaking, the first system gives the set *in the loom* and the latter system the set of the *finished cloth*.

The latter system may be reduced to a rule as follows :

To Find the Set of the Finished Cloth for any Ordinary Weave, such as Plain, $\frac{2}{2}$ Twill, $\frac{3}{3}$ Twill, etc.

Method.—Divide the diameter of the yarn by the threads + intersections (each = 0.732), and multiply by the threads in the repeat of the weave.

Attention may now be directed to the first class of modifying influences noted—viz., modifications caused by using yarns of various diameters, or by weaves which group certain threads and picks together, thus relatively strengthening them and modifying the structure. It is not here possible to do more than direct the attention of the student to these modifications, as it is very questionable whether it is possible, with the many varying factors, to bring all structures within any one rule; it seems more probable that a point has been reached at which the *art* of textile design attains to a leading place; but this art, nevertheless, may be most conveniently based upon the foregoing more or less scientific conditions. Certainly the following particulars, along with those already given, will prove most useful to the practical designer.

A recognised method of research is to go to extremes, and this method may be well applied here. The cloths so far considered have been formed with both components

—warp and weft—bending equally; now the two extreme types—viz., those in which weft only bends, the warp being perfectly straight, and those in which the warp only bends, the weft being perfectly straight—must be considered. The first are termed weft-rib structures, because the ribbed surface is formed by the weft; and the second warp-rib structures, because the ribbed structure is formed by the warp.

Weft-rib Structures.—The conditions of weft-rib structures are shown in Fig. 41, drawn in a similar manner to Fig. 39, but with all the warp-thread sections d, d in a straight line, the weft e, e doing all the bending.

It is at once obvious that the condition is more or less unnatural, for unless (1) the threads d, d are much thicker than the picks e, e , causing them to bend, or (2) the threads d, d are pulled straight in the finishing operation, it is evident that this structure is impractical and simply a result obtained on paper. But suppose the result is possible, what is the distance apart of the warp threads? for this, to the designer, is the main question. Now, it is evident that the threads may be any distance apart greater than the diameter of the weft, but if a weft angle of 60° with the warp is considered suitable,* then the set of the cloth may usually be obtained from the altitude of the triangle, which is just the diameter of the warp plus the diameter of the weft, and the space occupied by a thread plus an intersection equals 1.732 of

* The student must here understand that 60° is only selected in this case as a usual angle, but within certain limits any angle up to 45° may be decided upon.

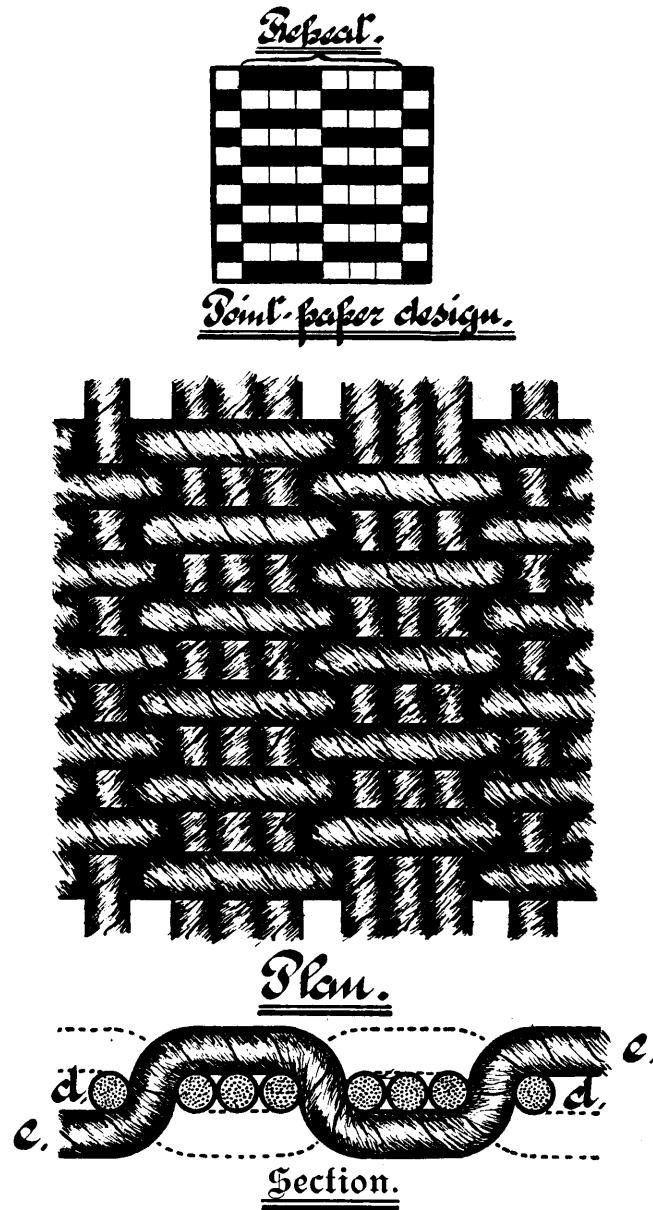

FIG. 41.—ILLUSTRATING A WEFT-RIB STRUCTURE IN PLAN AND SECTION

this, or a thread plus an intersection equal to 0.732 of the diameter of warp plus the diameter of weft.*

Example.—Find the set for a botany cashmere ($\frac{2}{1}$ twill) made as follows :

<i>Warp.</i>	<i>Weft.</i>
All 56's botany	All 92's botany
(56's = $\frac{1}{1.5}$ of an inch).	(92's = $\frac{1}{2.05}$ of an inch).

The altitude of the triangle is—

$$\frac{1}{1.5} + \frac{1}{2.05} = \frac{1}{8.9} \text{ part of an inch, and } \frac{1}{8.9} \times 1.732 = \frac{1}{5.2} \text{ of an inch for the base of the triangle A, B, C.}$$

Then, since the $\frac{2}{1}$ twill contains in one repeat two triangles and one thread—

$$(\frac{1}{5.2} + \frac{1}{5.2}) + \frac{1}{1.5} = \frac{1}{2.6} + \frac{1}{1.5} = \frac{1}{2.2} \text{ of an inch.}$$

Thus, as $\frac{1}{2.2}$ of an inch is the space occupied by each twill of three threads, then—

$$22 \times 3 = 66 \text{ threads per inch.}$$

The picks per inch may be varied for quality from about 150 to 200.

This is a practical answer, as it happens, but it has not been worked out on precise and scientific lines, for the bending power of threads upon one another may be taken as the cubes of their diameters† inversely; thus 56's botany will bend 92's botany—

As $\frac{1}{2.05^3} : \frac{1}{1.5^3}$, and this has not been taken into account.

Another matter worth further consideration is the question of picks per inch, for, as in weft-rib structures, the weft forms the surface of the texture (see Figs. 41 and 42), it is naturally a most important component.

* The student is recommended to draw the diagram for plain cloth to these conditions.

† This is merely an approximation based upon observation.

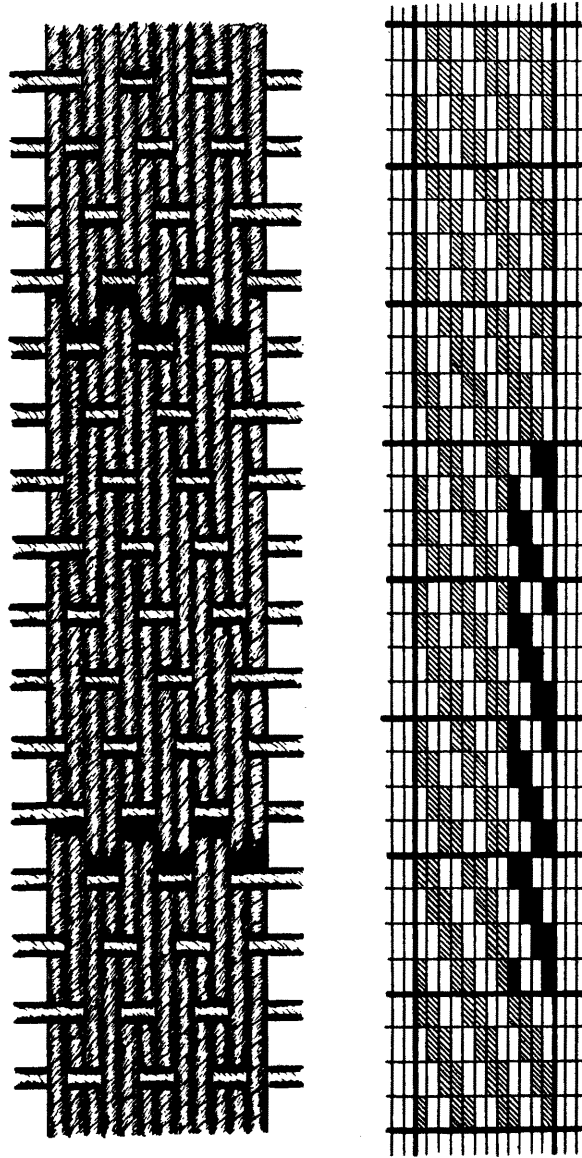

FIG. 42.—ILLUSTRATING AN ORDINARY $\frac{2}{3}$ TWILL INTERLACING EMPLOYED AS A WEFT-RIIB
Black point-paper section represents the whole of the plan of fabric given

In the examples given—with the warp perfectly straight—as many picks per inch can be inserted as the diameter of the yarn will allow ; but it is also well to note carefully that as greater value and more bending is given to the warp fewer picks will be required, until eventually equal quantities of warp and weft will be employed—*i.e.*, an ordinary structure produced. Carrying out the idea still further, finally a warp-rib structure results, in which the warp-threads do all the bending, lying close to one another, and the picks straight and separated at least by the diameter of the warp-threads.

Every possible condition may be expected in practice, but a thorough comprehension of the foregoing particulars will enable the designer to experiment under favourable conditions. For instance, a $\frac{2}{2}$ hop-sack cloth presents the same section as the $\frac{2}{2}$ twill, but owing to *the manner in which the picks follow one another*, a different set is required ; for, while in one repeat of the $\frac{2}{2}$ twill there are four points of intersection—all of which at one time or another are occupied by the weft—in $\frac{2}{2}$ hop-sack the four possible points of intersection are only occupied twice out of the four, certain of the threads never being separated by weft intersections throughout the piece ; hence a closer set may be employed (see also Fig. 49).

Warp-rib Structures.—The treatment of warp-rib structures will be exactly the reverse of weft-rib structures, so there is practically no need to exemplify them here.

SUMMARY ON THE SETTING OF CLOTHS

Before leaving this subject the student should clearly realize how he is to make the scientific principles the basis of the 'Art of Cloth Construction,' for he must be in a position not only to explain what has been done, but to press forward with confidence on to untrodden paths.

The following will be the most convenient line of thought :

1. The yarns to be employed, their nature and their diameters.

2. The weave structure most suitable for each class of yarn, and the setting required for—

(a) Ordinary structures.

(b) Weft-rib structures.

(c) Warp-rib structures.*

3. The effects of finish, etc., on the resultant cloth.

Example.—Soft cloths are in fashion ; what varieties can be obtained with $\frac{2}{2}$ twill ?

1. With a mule-spun 30's botany (diameter $\frac{1}{118}$) and, say, a 40's weft (diameter $\frac{1}{134}$), it is probable that a very nice cloth can be produced.

2. (a) Ordinary structure $\left\{ \begin{array}{l} 90 \text{ threads per inch.}^\dagger \\ 90 \text{ picks per inch.} \end{array} \right.$

(b) Weft-rib structure‡ $\left\{ \begin{array}{l} 80 \text{ threads per inch.} \\ 134 \text{ picks per inch.} \end{array} \right.$

(c) Warp-rib structure‡ $\left\{ \begin{array}{l} 116 \text{ threads per inch.} \\ 84 \text{ picks per inch.} \end{array} \right.$

* In sateen structures a curious averaging up of the strains of the intersections takes place ; hence nearly as many picks as threads can be introduced (see Fig. 49).

† Finished cloth. ‡ An angle of 45° is here taken.

3. As (a) would be a very ordinary style, a range of experiments is carried out with the interlacing indicated in Fig. 42, and to develop the weft-rib the fabric may be 'crabbed' and treated very strongly in finishing, thus straightening the warp and bending the weft as required to give a weft surface with 'cuts' formed at varying distances.

Other Factors to be Considered.—In the foregoing treatment the main factors only have been taken into account. For the benefit of those who would consider the matter further, the following list of influences which have not been definitely taken into account is given :

- (a) The nature of the materials employed.
- (b) The arrangement of the fibres in the thread structure.
- (c) The influence of twist on the diameter of the yarn and on its weaving and finishing properties.
- (d) The effect of direction of twist of warp and weft in relation to weave.
- (e) The compression of yarns in weaving.
- (f) Contraction of the cloth in weaving.
- (g) Contraction of the cloth in finishing and loss of oil, fibre, etc.*

Weight and Cost Calculations.—If the student has comprehended the foregoing calculations all else will be comparatively simple. For instance, in calculating the weight of a piece, if (a) the length of material in the piece, and (b) the yards per pound of the material, are given, the cost of the material in the piece may be ascertained in a few moments.

* See the author's work on 'Pattern Analysis.'

Example.—Find the weight of a fabric woven as follows :

Warp.
All 2/40's botany,
64 threads per inch.

Weft.
All 1/20's botany,
64 picks per inch.

Width of piece in reed 34 inches.

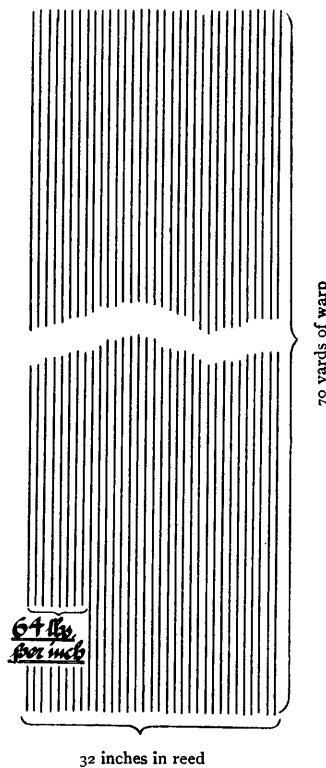

FIG. 43.—GRAPHIC ILLUSTRATION OF WARP CALCULATION

Length of warp 70 yards, yielding 64 yards of cloth in the grey.

Now, $64 \times 34 = 2,176$ threads, and as each one of these is 70 yards long, $2,176 \times 70 = 152,320$ yards of material in the warp. But there are $560 \times 20 = 11,200$ yards of this material per pound ; so

$$152,320 \div 11,200 = 13\frac{3}{5} \text{ lbs.}$$

of material in the warp. This is graphically represented in Fig. 43.

For the weft calculation work in a similar manner ; thus $64 \times 34 = 2,176$ inches of yarn in 1 inch, therefore yards of yarn in 1 yard of the cloth. And

$$2,176 \times 64 = 139,264$$

yards of weft in the piece.

But there are $560 \times 20 = 11,200$ yards of this material per pound, so $139,264 \div 11,200 = 12\frac{7}{15}$ or about $12\frac{1}{2}$ lbs. of material in the weft.

It will here be noted that the length of the grey

cloth (64 yards) and not the length of the warp (70 yards) is taken, but in worsted coatings, instead of allowing a percentage for waste of weft it is customary to calculate the weft for the full length of warp (70 yards in this case).

The cost of the materials in the piece may readily be found if the price per pound is given. Thus, if the cost of 2/40's is 2s. 10d., and 1/20's 2s. 9d., then—

	£	s.	d.
13 $\frac{3}{8}$ pounds × 34 = 462 $\frac{1}{2}$ d.	1	18	6 $\frac{1}{2}$
12 $\frac{1}{2}$ pounds × 33 = 412 $\frac{1}{2}$ d.	1	14	4 $\frac{1}{2}$
Total cost of materials	3	12	11

All such calculations as these should be treated as certain heald and reed, etc., calculations in Chapter II. have been treated.

Whenever possible practical tests—say, 10-yard pieces—should be made, and measured at every stage, in order that the bulk may be correctly estimated for.

The following set of formulas will be readily understood; such a set should be drawn up by each designer to suit his own particular needs, *care being taken that each formula acts in all cases, not in one or two particular cases:*

$$N \times W \times L = P \times C \times H.*$$

$$\therefore \frac{N \times W \times L}{P \times H} = C.$$

$$\frac{N \times W}{P \times C \times H} = L.$$

$$\frac{N \times L}{P \times C \times H} = W.$$

$$\frac{W \times L}{P \times C \times H} = N.$$

* N=threads or picks per inch; W=width of piece in loom; L=length of warp or grey cloth; P=lbs. weight; C=counts; and H=yards per hank.

In this treatise the question of weaving, etc., wages, cost of finishing, etc., is not touched upon, being here out of place.

Changing the Weights of Cloths.—Heavy winter styles may be required in lighter summer makes, or light summer styles may be called for in heavier winter makes; hence it is desirable to understand thoroughly the various methods of changing the weights of fabrics.

There are four methods—viz., (1) by changing the counts of yarn, (2) by changing the set or picks, (3) by changing both counts and set, (4) by any empirical method which fits a fair number of cases. One might add a fifth method—viz., adding a warp or weft back, or a ‘wadding’ pick, or another cloth—*i.e.*, double cloth.

Example.—The set for 32’s worsted yarn in an ordinary $\frac{2}{2}$ twill is found to be 88 threads per inch.

1. To make this cloth as heavy again a 16’s yarn may be employed. But how can a 16’s yarn with $\frac{2}{2}$ twill be weavable if 32’s yarn is weavable?

2. Similarly, 176 threads per inch may be employed; but is it possible to get 176 threads of a 32’s yarn into an inch with $\frac{2}{2}$ twill weave?

3. By changing both counts and set it is possible to (a) obtain the required weight, (b) retain the same *balance of structure*. Why this should be possible requires careful thought, but the following brief explanation will probably help the student to thoroughly comprehend the conditions.

As shown in Figs. 44 and 45, to add weight to a cloth

its thickness must be increased ; to increase its thickness thicker yarns must be employed ; to employ thicker yarns fewer threads and picks must be employed.* The question now arises, In what proportion shall any increase or

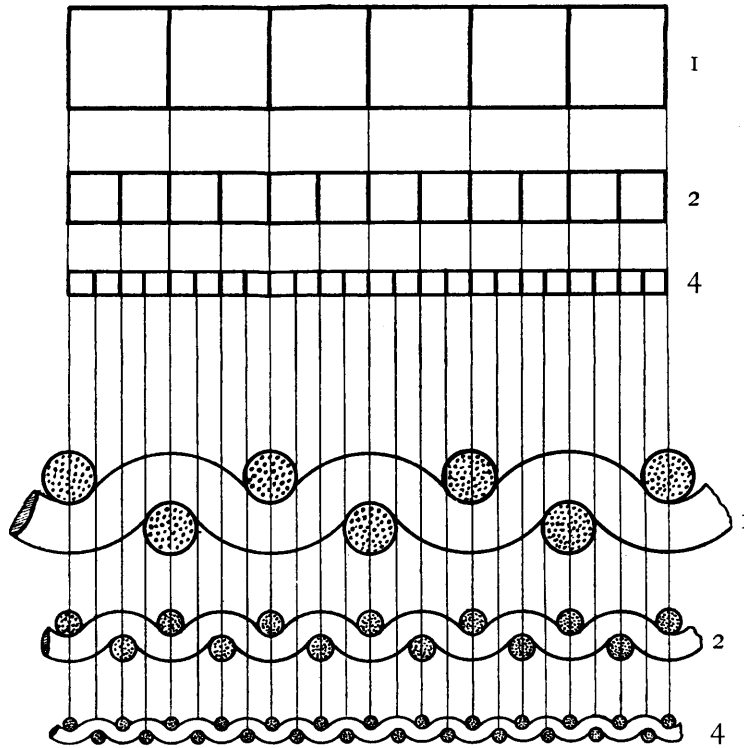

FIGS. 44 AND 45.—ILLUSTRATING GRAPHICALLY THE THEORY OF VARYING CLOTHS IN WEIGHT

decrease be made in counts and set? If, for instance, a cloth is required double the weight—*i.e.*, As 1 : 2—*will the proportion for the count, set, and picks be—As 1 : 2?*

* Let the student, looking at the diagram, state the conditions for decreasing the thickness of a cloth in the same way.

1. For the count the change will be inversely—viz., as 2 : 1, a lower number giving a thicker yarn.

But, further, to change the thickness of the cloth it is the diameter of the yarn which must be changed as 1 : 2, and as the $\sqrt{\text{counts}} = \text{diameter}$, the required change in counts will be—

As 2 : 1 :: $\sqrt{\text{counts in original cloth}}$: $\sqrt{\text{counts in new cloth}}$.

2. As a yarn with a greater diameter is now to be employed, a lower set will be necessary just in this proportion—viz., as 2 : 1 :: set of original cloth : set of new cloth.

In Fig. 44 the increasing or decreasing of cloths in multiple proportion is shown, simply in squares, to emphasize the principle. In Fig. 45 the thread structure is shown on similar lines.

From these particulars the following induction may be made :

Rule.—Increase or decrease the thickness of the cloth—*i.e.*, the diameter of the yarns (the $\sqrt{\text{of the counts}}$ inversely) employed—in the proportion required. Also decrease or increase the number of threads and picks in the same proportion. One of the most difficult calculations is the following :

1. Design a cloth to a given weave—say, $\frac{2}{2}$ twill—perfectly balanced in structure and of a given weight per yard—say, 16 ounces.

2. Change the cloth to $\frac{1}{4}$ heavier (*i.e.*, four-fourths become five-fourths, therefore proportion is as 4 : 5)—*i.e.*, 20 ounces.

3. Change the weave from $\frac{2}{2}$ to $\frac{4}{4}$ twill (thus making the cloth more than 20 ounces).
4. Bring the cloth back to 20 ounces, retaining the $\frac{4}{4}$ twill, and maintaining the perfect structure.

In concluding this chapter the writer can only add that if the student has truly realized all that has been demonstrated, and has carried out for himself the graphic illustrations suggested, there are no calculations of any practical value which he will be unable to tackle.

CHAPTER V
THE DESIGNING OF INTERLACINGS ON
POINT-PAPER

IT is a recognised principle that to speak any language other than one's mother-tongue one must be able to *think* in that language. Similarly with textile design—in order that the designer may express what he wishes in textile structures *he must think in the structure itself*. Every medium lends itself to a particular style of design; thus, with a pencil one tends to design in line, with a brush in mass; to design stained glass in broken mass, and so on. Now, squared paper (*i.e.*, point-paper) lends itself to a particular style of design, and the first mistake the student invariably makes is to think in point-paper and not in the thread structure. This must be guarded against, the best way being to design a set of apparently effective plans on point-paper—say, 16 threads and 16 picks—and try them on a suitable warp. The student will then appreciate the value of thinking in the structure itself, employing point-paper only as a means of expressing his thoughts.

But although this must be recognised and acted upon, it does not follow that point-paper may not be employed in working out new styles. The student should certainly

base his ideas on the structure itself, *but he should also train himself to think in the structure while designing on point-paper*. This is the basis of the following treatment, point-paper being employed as the medium for designing in, while the criticism of the results is based upon the actual appearance of the resultant structure.

DEVELOPMENTS FROM PLAIN WEAVE

Plain weave is the simplest possible structure, but it may be modified in several ways, yielding several interesting and useful effects for employing alone or in combination. Thus No. 1, on Design Sheet 2, is nothing but plain weave with 2 picks in a shed, No. 2 with 3 picks in a shed, and No. 3 with 4 picks in a shed. No. 4 has 2 threads working together, No. 5 has 3 threads working together, and so on. In No. 7 plain weave is the basis with 2 picks and 2 threads together, No. 8 with 3 picks and 3 threads together, and No. 9 with 4 picks and 4 threads together. Nos. 10 to 13 are mixed, and No. 14 is the most complex style of the series.*

It should be noted that while Designs 1, 2, 3 are the most easily produced, the shuttle simply being passed through the same shed twice, three times, and four times, yet designs 4 and 5 present an advantage, for in the three former designs a 'catch-end' must be placed at one or both ends of the cloth (unless the loom is a box-loom†) to prevent the insertion of the second pick drawing out the first pick, and so on. The same remark applies to Nos. 7, 8, 9, and 14. Nos. 1 to 3 are known as warp-ribs, as the cloth presents a warp surface, the weft being hidden ;

* All these styles may be produced with two-heald shafts.

† The student should think very clearly upon these practical points.

Nos. 4, 5, and 6 are known as weft-ribs for similar reasons, and Nos. 7, 8, 9, and 14 are known as hop-sack, Celtic,

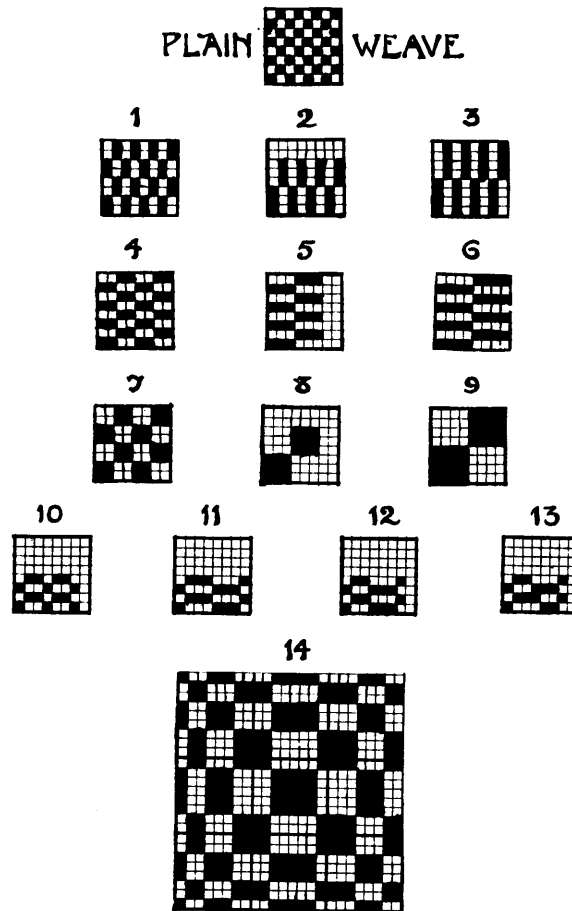

DESIGN SHEET 2.—ILLUSTRATING THE DEVELOPMENT OF WARP-RIBS, WEFT-RIBS,
AND HOP-SACKS FROM PLAIN WEAVE *

* The student should also experiment with these weaves in yarns of different thicknesses—say, for example, No. 10 warped 1 thread 2/80's cotton, 2 threads 2/20's cotton; and wefted 1 pick 2/10's cotton, 1 pick 2/80's cotton.

or mat weaves. As these have already been dealt with in Chapter IV., no further consideration is here called for.*

TWILLS AND DIAGONALS

A twill structure is one in which the interlacing produces lines running *diagonally* across the piece. If the lines are only lightly defined, the structure is spoken of as a 'twill'; if strongly defined and of a varied character, as a 'diagonal,' although the terms are practically synonymous.

The angle of these lines to the horizontal (or perpendicular) may be varied by, *first*, the angle of the interlacing or the move (*i.e.*, the point-paper design); and, *second*, the proportion of threads to picks in the resultant cloth.†

There are many varieties of twills; the following will be found a convenient classification:

- (a) Ordinary twills.
- (b) Compound twills.
- (c) Combination twills and Crape weaves.
- (d) Broken twills.
- (e) Sateens and sateen twills.

Most authorities class the sateens as twills, but the idea of construction in the sateen is anything but the twill form. Thus the sateens really form a link between ordinary weave structures and the more elaborately figured styles.

(a) ORDINARY TWILLS.—The simpler twills are the first advance on plain weave, the idea of construction being to move the intersection one horizontally and one

* Refer to pp. 82, 84, diagrams.

† The student should clearly realize these points by making a few experimental sketches, or, better still, by trial on the loom.

vertically, leaving two or more threads and picks between the repetition. This will be fully understood by reference to Design Sheet 1 (p. 23). No. 15 is the $\frac{2}{1}$ twill warp face, No. 17 is the $\frac{2}{2}$ twill with equal quantities of warp and weft, and No. 19 is the $\frac{3}{2}$ twill weft face. Thus it will be evident that, in addition to the variations previously noted, twills may have equal quantities of warp and weft on the surface, or they may be warp-face—*i.e.*, more warp on the surface; or they may be weft-face—*i.e.*, more weft on the surface. If the warp is good and the weft poor a warp-face twill is naturally employed; if the warp is poor and the weft good a weft-face is naturally employed.

Again, the student must not forget that by varying the proportion of picks to threads in the actual structure a marked difference in the resultant cloth is to be noticed; thus the $\frac{2}{1}$ weft twill* and the $\frac{4}{1}$ weft sateen† are frequently woven with twice as many picks as threads per inch, with the result that the face twill angle is much less than 45° while, strange to relate, the back appears plain—hence the term ‘plain back.’

The origination of simple twills—say, on 8, 10, 12, etc., threads and picks—is of much importance, since a good designer should realize to the utmost the capacity of his machinery. Further, the following *principles of working* are such that the designer who would be really capable cannot afford to ignore them.

Suppose, for instance, that all possible twills producible

* Cashmeres.

† Italians.

upon twelve shafts are required, proceed as shown in Design Sheet 3. Commencing with a single row of 12 dots in No. 1, add another row for No. 2, two rows for No. 3, and so on, eleven effects being thus obtained. Then two rows

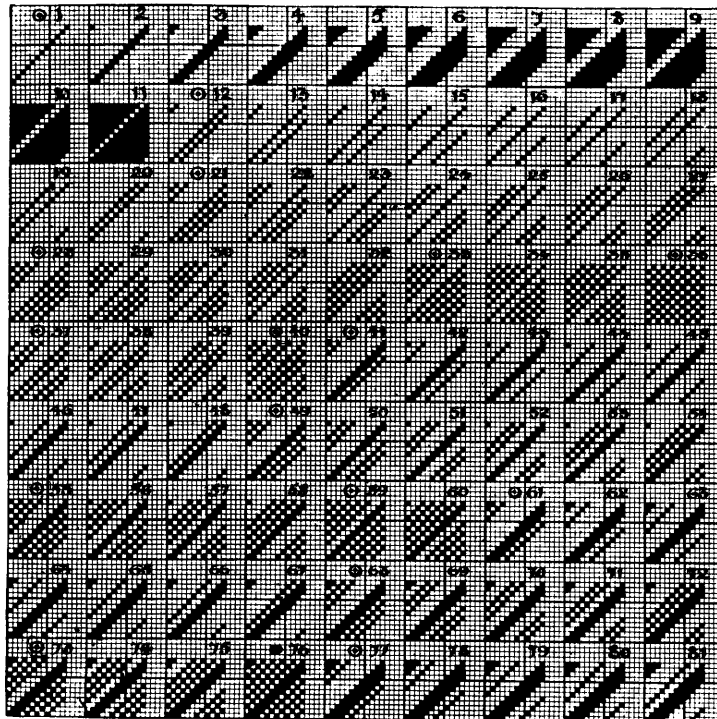

DESIGN SHEET 3.—ILLUSTRATING THE SYSTEMATIC ORIGINATIONS OF SIMPLE TWILLS
 ⊙ = the commencement of a new basis

of dots, as shown in No. 12, should be taken, and gradually placed further apart, as indicated. Then one single and one double row should be taken, as illustrated in No. 41, and again all possible effects worked out, and so on. In other words, the designer should *design the system upon*

which he will originate new effects, working in such a manner that there is nothing haphazard, but rather *efficient and complete work throughout*. It may appear useless carrying out Designs 1 and 11, 2 and 10, 15 and 17, etc.; but *complete* results are worth a great deal as a basis for future research, and in this case, after one set of twills has been completed, the principles for research on other numbers of threads and picks are so apparent that no further trouble will be encountered in making as many twills as required.

Another matter which concerns all twills, and to a certain extent plain cloths also, is the 'direction of twist' in the warp and weft yarns.

The Influence of Twist on Cloth Structure.—Obviously, yarns may be twisted to the right (open-band) or to the left (cross-band), according to whether the spindle-bands upon the mule or frame are open or crossed, or the machine running reverse-twist or not (Fig. 46). Now, on first thought, the direction of twist in yarns may not seem to be of pressing importance, but after the student has served a short apprenticeship to designing he will be struck with the appearance illustrated in Fig. 47—viz., that when a twill runs to the right it shows up much more distinctly than when it runs to the left. The reason for this is not far to seek. As shown in Fig. 46 at A, when warp and weft yarns are twisted in opposite directions, upon being laid across one another at right angles (as they will be in the cloth) the twists cross one another, since the *upper* surface of one yarn is in contact with the *under* surface of the other yarn; hence they tend to stand off from one another, leaving the structure distinct.* This separation appears to be further accen-

* Hence these conditions should be the best for wear.

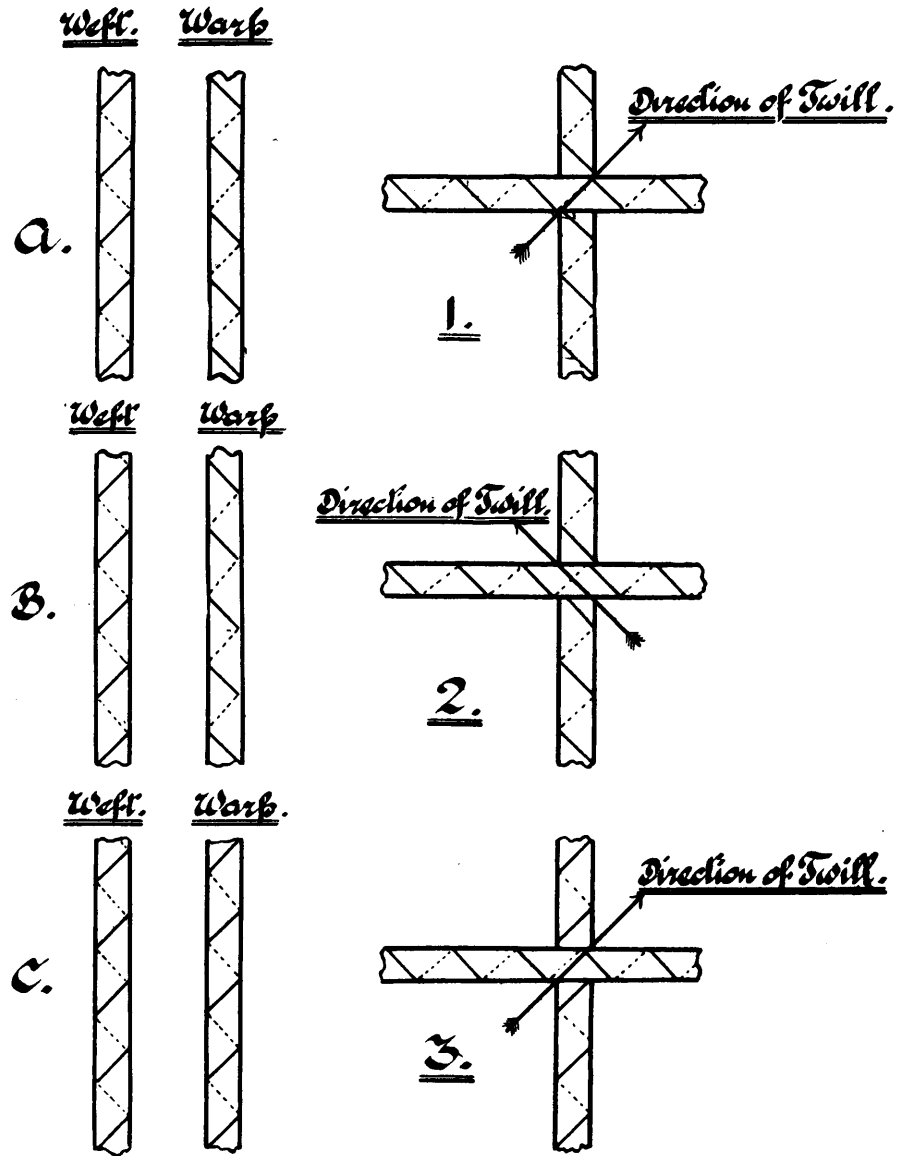

FIG. 46.—ILLUSTRATING THE VARIOUS CONDITIONS OF TWISTING AND TWILLING

tuated by making the twill (if the structure is a twill), as indicated, oppose the surface direction of the twist of the yarns. If, as in Meltons and many woollen goods a

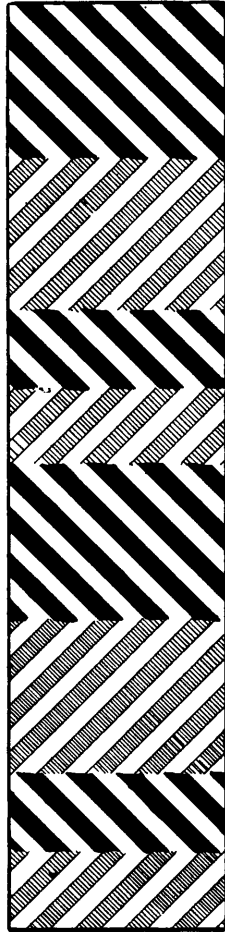

FIG. 47.—ILLUSTRATING THE INFLUENCE OF TWISTING AND TWILLING

close, compact, structureless texture is required, then warp and weft must be twisted in the same direction (Fig. 46, C), so that in the cloth they 'bed' into one another, while if the weave is a twill it must be made to run with the 'bedding' twists of the yarns. Fig. 46 represents all the possible conditions except one which the student may draw for himself. A little thought and a few experiments with cords or rovings twisted and laid across one another will demonstrate the necessary conditions for any required structure.

The Repetition of Twills.—A word of warning is necessary respecting the 'repetition' of twills. If the student refers to p. 25, and thoroughly understands what is there written, he will be able to repeat twills correctly, but under any circumstances he should experiment with

the repetition of complex twills, as indicated in Design Sheet 4. In No. 1 the dividing up of the design-paper into repeats of the weave is illustrated, the weave being

filled into each repeat, perfect joining resulting. Nos. 2 and 3 are more difficult, while a distinct method of repetition is shown in designs 5 and 6.

(b) COMPOUND* TWILLS.—These twills are compound in the sense that two or more simple weaves are employed in their construction, as illustrated in Design

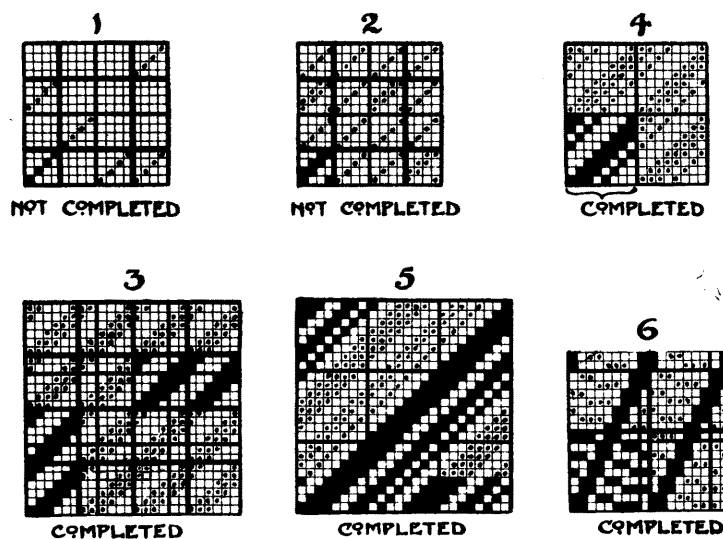

DESIGN SHEET 4.—ILLUSTRATING THE REPETITION OF WEAVES

Sheet 5, No. 1. The elements of which the large twill is compounded may be twills or weaves other than twills, but under any circumstances they are combined to give in the total result a twill of a more marked character. Two points must be specially attended to: *Firstly*, to select for combination weaves which naturally will fit well

* The word 'compound' has no special significance; it is here employed simply because it is the most *convenient* word.

together; *secondly*, to select weaves which will weave well together—*i.e.*, are of equal, or nearly equal wefting

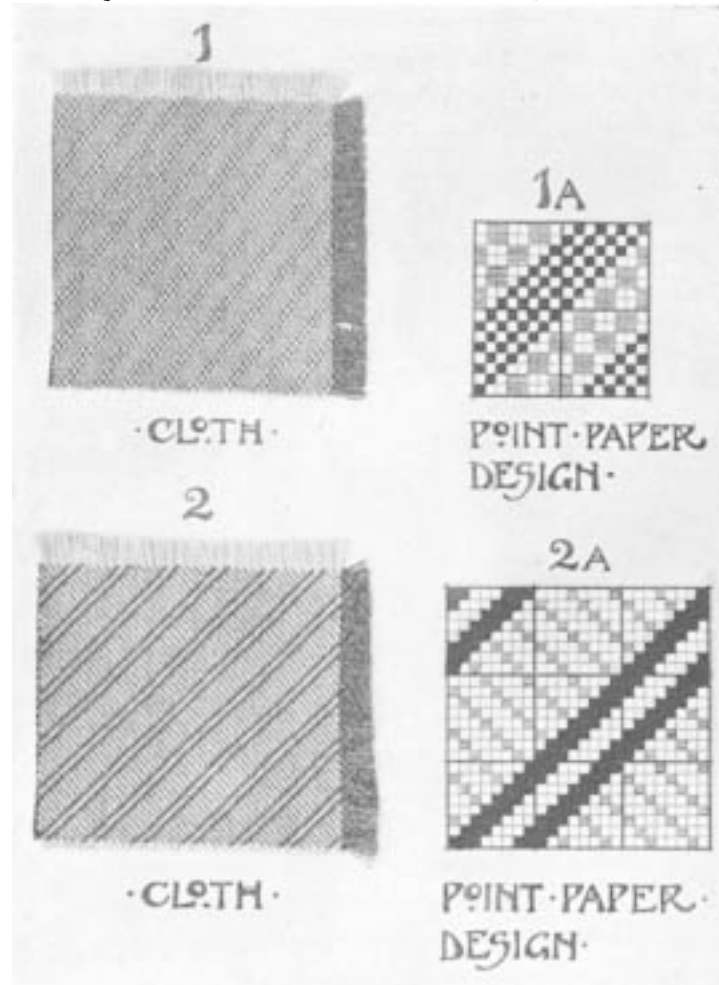
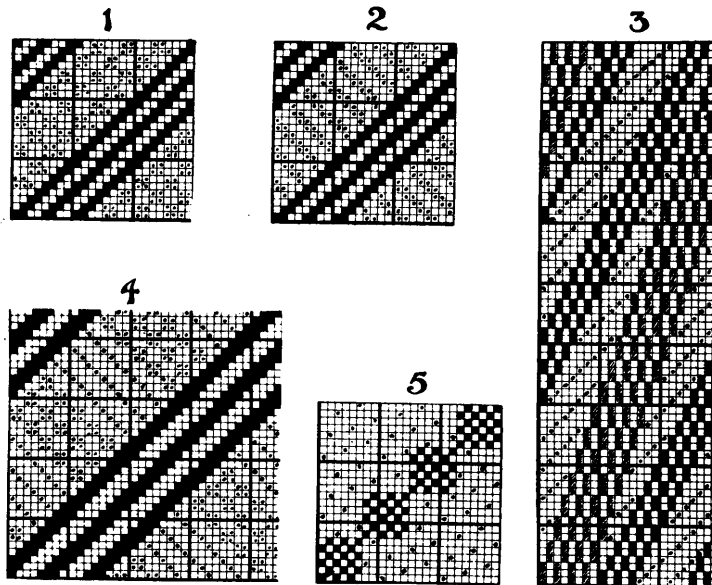

PLATE 3.—COMPOUND TWILLS

capacity, or are combined in such a way that they will weave well together. In No. 2 the angle of the resultant

twill is 45° , and the weaves in combination are twills at 45° . In No. 3, while the main twill runs at about 72° , the component twills run at different angles; hence the difficulty in 'cutting' or joining up the weaves one to the other. In No. 4 a practically perfect twill is indicated so far as weaving capacity is concerned, while in design No. 5



DESIGN SHEET 5.—ILLUSTRATING COMPOUND TWILLS

the weaves combined are of such different weaving capacity that one weave must be sacrificed to the other—in this case the sateen to the plain weave, this weave limiting the number of threads and picks per inch.

(c) COMBINATION* TWILLS.—These twills, in one sense,

* The term 'combination' is employed just as 'compound'—*i.e.*, because it is a convenient term.

are similar to compound twills—that is, they are compounded of two or more weaves. As the order of combination is here the chief factor, they are given the title ‘combination’ twills.

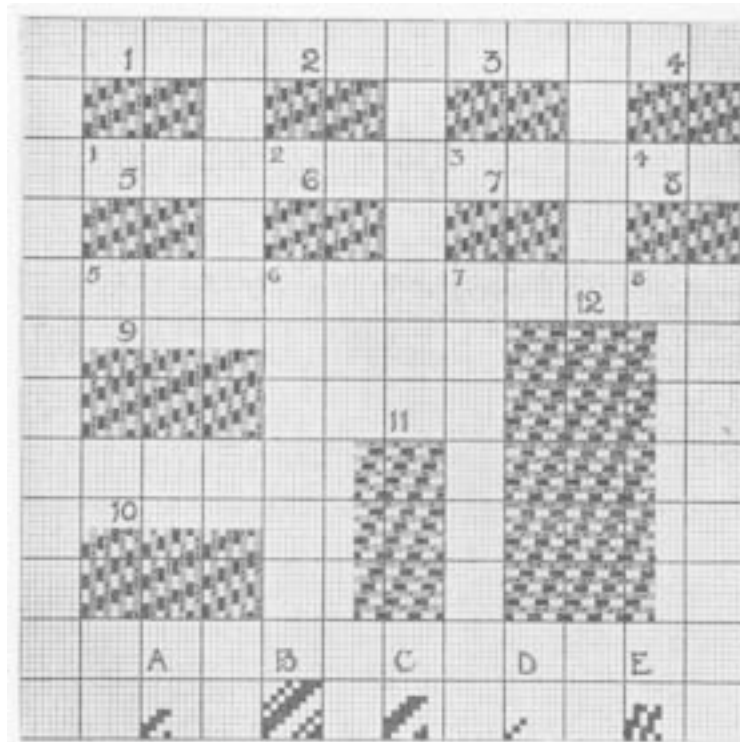

DESIGN SHEET 6.—ILLUSTRATING COMBINATION TWILLS

The idea lying at the basis of these structures is *the mixing up or combining of two or more weaves to produce another totally different weave*. For example, weaves A and B on Design Sheet 6 may be employed in a thread and thread combination.

The following example illustrates *the method*, which is the important thing for the student to note :

1. Mark off 16 threads \times 8 picks for eight effects or designs.
2. Paint in all the even threads in some transparent colour.
3. Upon the odd threads insert weave A, *always commencing on the same thread*.
4. Upon the even threads insert weave B, in the first design commencing with the first thread, in the second with the second thread, and so on as indicated, thus producing apparently eight distinct twills which should now be painted in solid colour, in order to judge of their respective merits.

Examination reveals that the four last effects are duplicates of the first four, and the fact that weave A is a four-thread weave suggests the explanation which the student must confirm experimentally. Thus in Nos. 9 and 10 weaves A and C are combined, and two effects are evidently possible, as shown, and no more.

Again, on combining weaves A and D one design only will be obtained, for if the weaves are put down one alongside the other,* repetition occurs on the thirteenth thread, there being four repeats of the three-thread twill and three repeats of the four-thread twill. Hence, when the weaves are combined pick-and-pick, the design occupies 12 threads by 24 picks, and the picks, having been in every possible relationship to one another, only one effect, as here given, can be produced.

The student should now, from these particular examples,

* The student should do this for his own satisfaction.

endeavour to induce a rule which will apply in all cases, thus :

Weaves on 4 threads and 8 threads give four effects.

Weaves on 4 threads and 6 threads give two effects.

Weaves on 3 threads and 4 threads give one effect.

Upon carefully thinking over these results, and others which may be obtained on similar lines, the student will speedily note that *the number of combinations producible from the combination of any two weaves will be the greatest common measure of the two weaves.**

It will now be noted that the foregoing effects are very regular, but if an upright twill weave (E) be combined with an ordinary twill weave (A) the resultant twill is more or less irregular, as shown, and experiments with various weaves show that—

Regular + regular weaves give regular combinations.

Irregular + irregular weaves give regular combinations.

Regular + irregular weaves give irregular combinations.

The drafting of these designs is very interesting, but as the student is at present studying weave structure it must be reserved for future treatment.†

CRAPPE WEAVES.—These are best treated here, as they are simply thread-and-thread *and* pick-and-pick combination effects, receiving the name ‘crape’ owing to their broken-up mealy appearance, this being usually associated

* The student must convince himself of this by carrying out at least a dozen experiments.

† The student should note, however, that while weaves A and E, for example, combined thread and thread would give a design on 40 threads, yet there are only 9 *orders* of threads, thus only 9 heald-shafts will be required. He should also experiment with combinations of threads in groups of two or more.

with the term crape. In this case one weave only is required, as illustrated in Design Sheet 7, weave A.

Proceed as follows :

1. Taking twice as many threads and picks as the design occupies, paint every other thread and pick in some light shade—this is for convenience only.

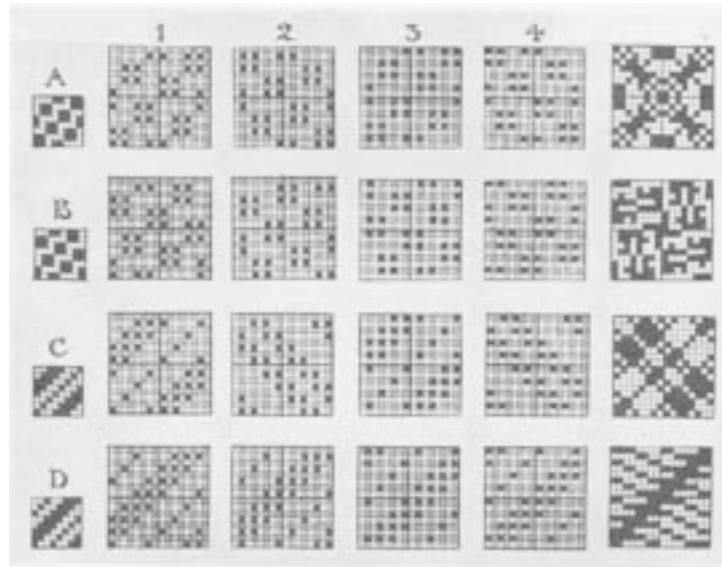

DESIGN SHEET 7.—ILLUSTRATING THE ORIGINATION OF CRAPE WEAVES

This method has been originated by the well-known head of the Aachen School of Weaving and Designing

2. Now put in the weave on the white spaces only, as shown in 1, commencing on the first thread and pick.

3. Turn the paper round 90°, and put the weave down as before, as shown in 2.

4. Turn the paper another 90°, and again insert the weave, as shown in 3.

5. Turn the paper another 90° and again insert the

weave, as shown in 4. Thus weave A will be contained four times in the new design, which, nevertheless, is quite unlike the initial design.

6. Having obtained the resultant weave, it should be painted out clearly, as shown, so that its merits may be fairly estimated.

The following modifications of the system are possible :

Weave B, by commencing with, say, the second or third thread instead of the first.

Weave C, by painting in such a weave C as given for the first time, the reverse of C for the second, C for the third, and the reverse of C again for the fourth, the result being as indicated.

Weave D, by combining one weave or more with the twill running in the reverse direction—*i.e.*, first to the right then turn the paper 90° and insert twill to the left, and so on, as indicated.

By employing two or more weaves on similar lines other styles may also be produced.

The defect of this system of designing seems to be that it is impossible to foresee the resultant effect ; but as very useful styles may thus be originated, the designer cannot afford to ignore this somewhat mechanical method.*

As suggestions for diaper, etc., designs this system is specially useful.

(*d*) BROKEN TWILLS.—These are produced by taking any suitable twill as a basis and breaking it up, so that a more or less crape or broken appearance results.

* As a patent for this system of designing is claimed by the originator—the late Director of the Aachen Textile School—those wishing to employ this method should communicate with him direct.

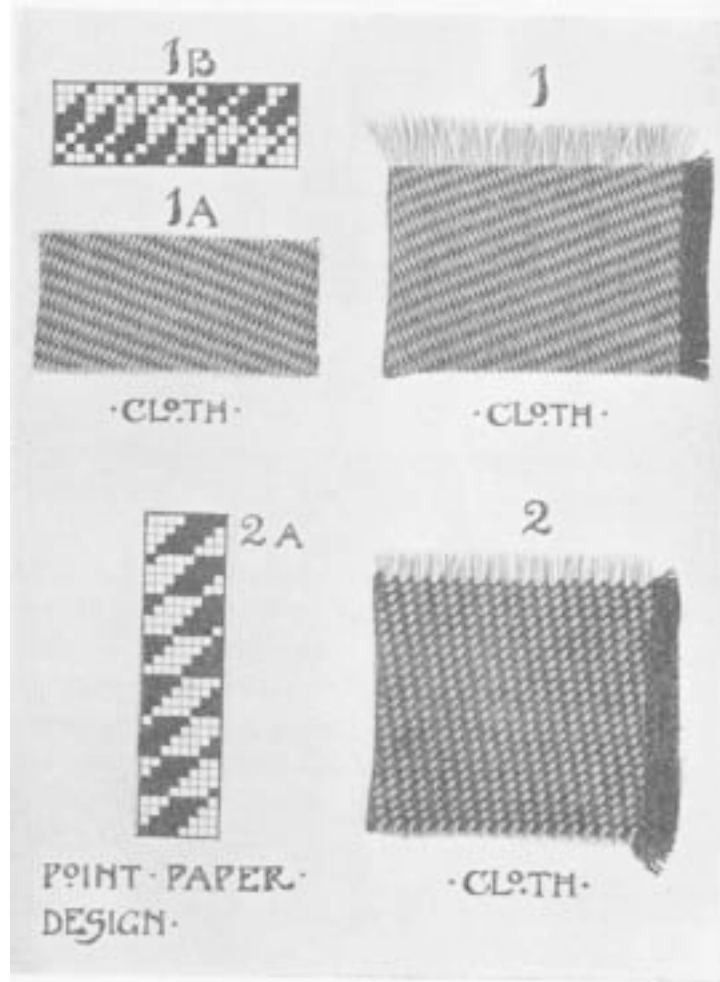

PLATE 4.—REARRANGED TWILLS